

# Music Life **INFINITY**

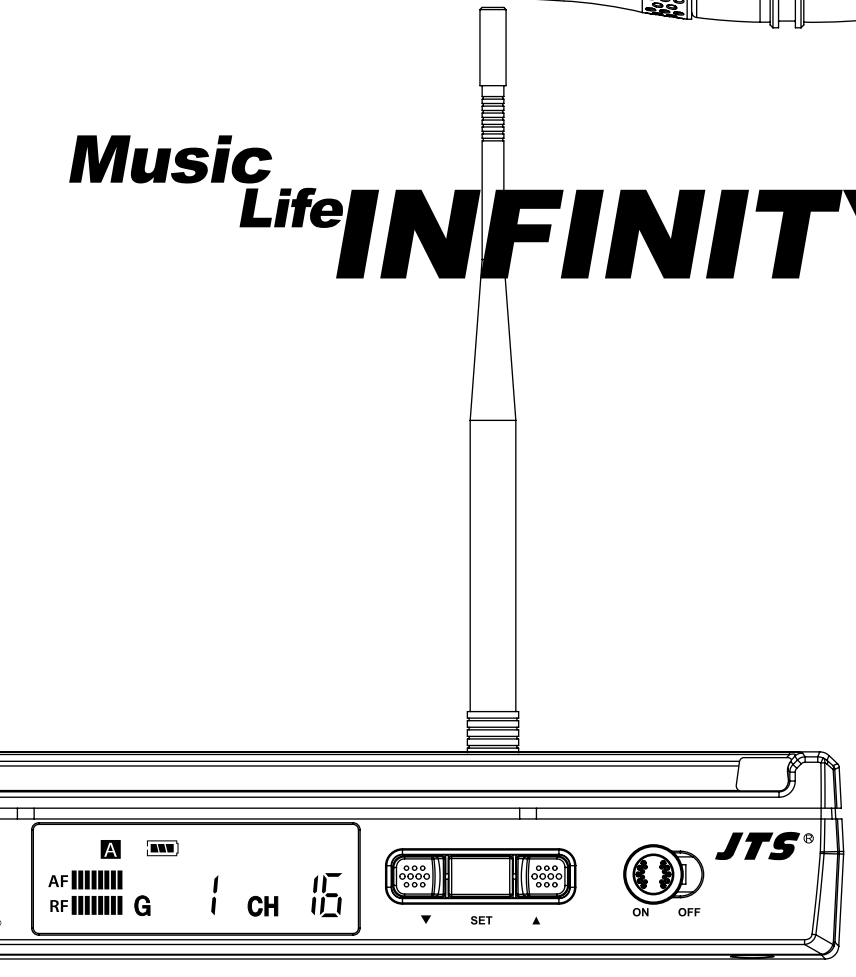

## UHF PLL Single Channel Diversity Wireless System

\* The system is of the innovative design to allow changing the transmitter's frequency by long-distance .

\* IN164R with band width of 36 MHz.

\* Preset 6 groups, maximum 23 channels in one group.

\* Operation distance from 200~480 meters.

**REMOSET®**

# IN164

Thank you for choosing the JTS wireless system. In order to obtain the best efficiency from the system, you are recommended to take a few minutes to read this instruction manual carefully.

# INDEX

1. Important Caution	1
2. Features	1
3. Specification	2
3-1 UHF PLL Single Channel Diversity Receiver // IN164R	2
3-2 UHF PLL Handheld Transmitter // IN264TH	2
3-3 UHF PLL Body-Pack Transmitter // IN264TB	3
3-4 Optional Condenser Microphone	3
4. Part Identification & Accessories	6
4-1 UHF PLL Single Channel Diversity Receiver // IN164R	6
4-2 UHF PLL Handheld Transmitter // IN264TH	7
4-3 UHF PLL Body-Pack Transmitter // IN264TB	8
4-4 Optional Condenser Microphone	8
4-5 Accessories	12
5. Connection	13
6. Operation	14
7. Recommendation	23
8. Important Notice	24

## 1. Important Caution

- Always makes all connections before plugging the unit into an AC power outlet.
- Do not leave the device in a place neither with high temperature nor high humidity.
- Always do not handle the power cord with wet hands!
- Keep the devices away from fire and heat sources.
- Pair the ID codes of the transmitter and the receiver to have proper function.

## 2. Features

JTS IN164 wireless microphone system is designed with the world first RF remote setting function (REMASET). A user can set the receiver with desired frequency and press the “REMASET” Key; then the transmitter will automatically be set. The operation distance can reach 10 meters. This brings great convenience to sound engineers during live performance.

IN164 is of 36MHz bandwidth to render 23 transmitters work simultaneously. It provides great convenience to large venue.

A new capsule has been developed for IN264TH. The capsule, SAM-8W, is designed for large venue with hundreds of thousands watt power. The SAM-8W delivers vivid details of vocal and instruments.

The IN164 is of stylish industry design. Yet JTS bombproof quality remains as always.

### 3. Specification

#### 3-1 UHF PLL Single Channel Diversity Receiver // IN164R

Frequency Preparation.....	PLL Synthesized Control
Remoset.....	Radio Frequency : 2.4GHz Effective distance: 10m
Carrier Frequency Range	36MHz within 502~960 MHz
S/N Ratio.....	>105dB
T.H.D.....	<0.6%@1KHz
Display.....	LCD
Display Contents.....	Channel, Antenna A/B, Mute Display, RF/AF Level Meter, Low battery, ID Number
Controls.....	Power On/Off, Frequency Up/Down, Lock-on, ID Pairing, Remoset
Audio Output Level.....	-12dB
AF Output Impedance.....	600Ω
Squelch.....	Pilot Tone & Noise Mute
Operation Voltage.....	12-18 VDC, 500mA
Output Connector.....	1 XLR Balanced Socket 1 Ø6.3mm unbalanced phone jack
Dimension(m/m).....	210mm(W) * 40mm(H) * 165.5mm(D)

#### 3-2 UHF PLL Handheld Transmitter // IN264TH

Frequency Preparation.....	PLL Synthesized Control
Carrier Frequency Range.....	502~960 MHz
RF Outputs.....	10mW / 50mW (Depend on Local Regulation)
Stability.....	±10KHz
Frequency Deviation.....	±48KHz
LCD Display.....	Channel, Battery Fuel Gauge, ID Number
Controls.....	Power On/Off, AF Level, Frequency Up/Down, Lock-on Mode, ID Pairing
Spurious Emissions.....	<-50 dBC
Audio Frequency Response	50~16,000 Hz
Battery.....	UM3, AA 1.5V*2

### 3-3 UHF PLL Body-Pack Transmitter // IN264TB

Frequency Preparation.....	PLL Synthesized Control
Carrier Frequency Range.....	502~960 MHz
RF Outputs.....	10mW / 50mW (Depend on Local Regulation)
Stability.....	±10KHz
Frequency Deviation.....	±48KHz
LCD Display.....	Channel, Battery Fuel Gauge, ID Number
Controls.....	Power On/Off, AF Level, Frequency Up/Down, PAD, Gain Control, ID Pairing, Lock-on Mode
Output connector.....	4P mini XLR
Spurious Emissions.....	<-50 dBC
Audio Frequency Response	40~18,000 Hz
Battery.....	UM3, AA 1.5V*2

### 3-4 Optional Condenser Microphone

#### Lavaliere Microphone

Model No.....	CM-501	CM-201	CM-125
Connector.....	4P Mini XLR	4P Mini XLR	4P Mini XLR
Frequency Response.....	100~15,000 Hz	60~15,000 Hz	50~18,000 Hz
Polar Pattern.....	Cardioid	Omni-directional	Omni-directional
Sensitivity (at 1000Hz)	-60±3 dB	-60±3 dB	-53±3 dB
Impedance.....	2.2kΩ	2.2kΩ	4.4kΩ
Max. SPL for 1% THD	130dB	130dB	130dB
Dimension(mm).....	Ø10.1mm(W) * 26.4mm(H)	Ø5mm(W) * 9mm(H)	Ø4mm(W) * 11mm(H)
Net Weight.....	21.5g	20.7g	7g (cable excluded)

## Headset Microphone

Model No.....	CM-204	CM-204U	CM-204UL
Connector.....	4P Mini XLR	4P Mini XLR	801C3 (3 pin mini XLR) 801C4 (4 pin mini XLR) 801CS (3.5 stereo plug)
Frequency Response.....	60~15,000 Hz	30~18,000 Hz	100 ~ 18,000Hz
Polar Pattern.....	Omni-directional	Cardioid	Cardioid
Sensitivity (at 1000Hz)	-60±3 dB	-68±3 dB	-75±3 dB
Impedance.....	2.2kΩ	680Ω	1.5kΩ
Max. SPL for 1% THD	130dB	130dB	120dB
Dimension(mm).....	125mm(W) * 134mm(H) * 157mm(D)	205mm(W) * 134mm(H) * 157mm(D)	125mm(W) * 134mm(H) * 157mm(D)
Net Weight.....	32.9g	38.4g	18g (cable excluded)

Model No.....	CM-225	CX-504
Connector.....	4P Mini XLR	4P Mini XLR
Frequency Response.....	50~18,000 Hz	30~18,000 Hz
Polar Pattern.....	Omni-directional	Cardioid
Sensitivity (at 1000Hz)	-53±3 dB	-68±3 dB
Impedance.....	4.4kΩ	680Ω
Max. SPL for 1% THD	130dB	130dB
Dimension(mm).....	155mm(W) * 134mm(H) * 157mm(D)	285mm(W) * 55mm(H) * 111.3mm(D)
Net Weight.....	17g (cable excluded)	56.3g

## Ear-hook Microphone

Model No.....	CM-801/CM-804i	CM-8015/CM-825i
Connector.....	801C4 (4 pin mini XLR)	801C4 (4 pin mini XLR)
Option Connector.....	801C3 (3 pin mini XLR)	801C3 (3 pin mini XLR)
	801CS (3.5 stereo plug)	801CS (3.5 stereo plug)
Frequency Response.....	60~15,000 Hz	50~18,000 Hz
Polar Pattern.....	Omni-directional	Omni-directional
Sensitivity (at 1000Hz)	-64±3 dB	-53±3 dB
Impedance.....	1.8kΩ	1.2kΩ
Max. SPL for 1% THD	130dB	130dB

## Compatible Instrument Microphone

Model No.....	CX-500	CX-500F	CX-520
Connector.....	4P Mini XLR	4P Mini XLR	4P Mini XLR
Frequency Response.....	20~20,000 Hz	50~18,000 Hz	50~18,000 Hz
Polar Pattern.....	Omni-directional	Omni-directional	Supercardioid
Sensitivity (at 1000Hz)	-58±3dB	-58±3dB	-78±3dB
Impedance.....	1.5kΩ	1.5kΩ	600Ω
Max. SPL for 1% THD	130 dB	130 dB	148 dB
Good For.....	Violin	Flutes	Harmonica

Model No.....	CX-508W	CX-516W
Connector.....	4P Mini XLR	4P Mini XLR
Frequency Response.....	50~18,000 Hz	50~18,000 Hz
Polar Pattern.....	Cardioid	Cardioid
Sensitivity (at 1000Hz)	-67±3 dB	-67±3 dB
Impedance.....	220Ω	220Ω
Max. SPL for 1% THD	130 dB	130 dB
Good For.....	Winds	Accordion



## 4. Parts Identification & Accessories

### 4-1 UHF PLL Single Channel Diversity Receiver // IN164R

#### Front panel

- 1 Power Switch
- 2 Channel Select: ▲ Up button
- 3 Channel Select: ▼ Down button
- 4 Channel Select: Set button
- 5 LCD Panel
- 6 REMOSET Key: press it to send a desired channel data to a transmitter
- 7 Volume Control

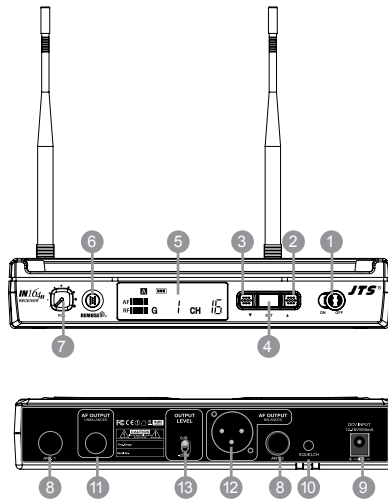

#### Rear panel

- 8 BNC antenna connector
- 9 Power Supply Jack (12-18V/500mA): for connecting the power supply unit
- 10 Squelch adjuster: to adjust radio signal level of both channels
- 11 Mixed AF Output (6.3mm jack, unbalanced): for connection to a balanced input, e.g. of a mixer or amplifier
- 12 Balanced XLR Output: for connection to the balanced input, e.g. of a mixer or an amplifier
- 13 Output Level Attenuation (-10dB,-20dB): to attenuate the balanced XLR output level by 10dB,20dB

## LCD Panel of the Receiver

- 14 AF Level: display the strength of audio signal
- 15 RF Level: display the strength of radio signal
- 16 Antenna Status: the receiver will automatically select an antenna with stronger signal level
- 17 Low battery indicator: display the low battery status of its transmitter
- 18 Group & Channel: there are 6 groups, maximum 23 channels in one group.

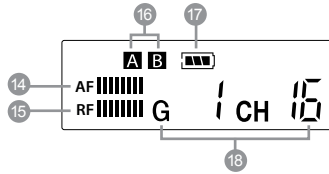

## 4-2 UHF PLL Handheld Transmitter // IN264TH

- 19 LCD Display
- 20 Battery Tray
- 21 Set button: set the configuration of handheld transmitter
- 22 Up button: select the settings of transmitter
- 23 Down button: select the settings of transmitter
- 24 Power and Mute Switch

## LCD Panel of the Handheld Transmitter

- 25 Battery status: display battery status
- 26 Group & Channel: there are 6 groups, maximum 23 channels in one group.

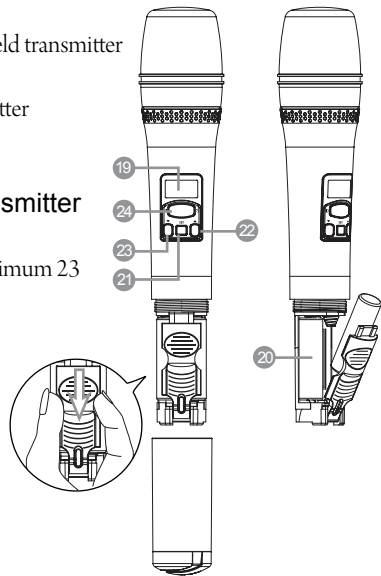
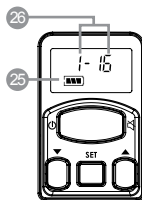

### 4-3 UHF PLL Body-Pack Transmitter // IN264TB

- 27 LCD Display
- 28 Battery Tray
- 29 Set button: set the configuration of bodypack transmitter
- 30 Up button: select the settings of transmitter
- 31 Down button: select the settings of transmitter
- 32 4 Pin mini XLR mic. input
- 33 Power Switch
- 34 Gain control: control sensitivity of the transmitter
- 35 Pad: -20dB, -6dB, 0dB

#### LCD Panel of the Body-Pack Transmitter

- 36 Battery status: display battery status
- 37 Group & Channel: there are 6 groups, maximum 23 channels in one group.

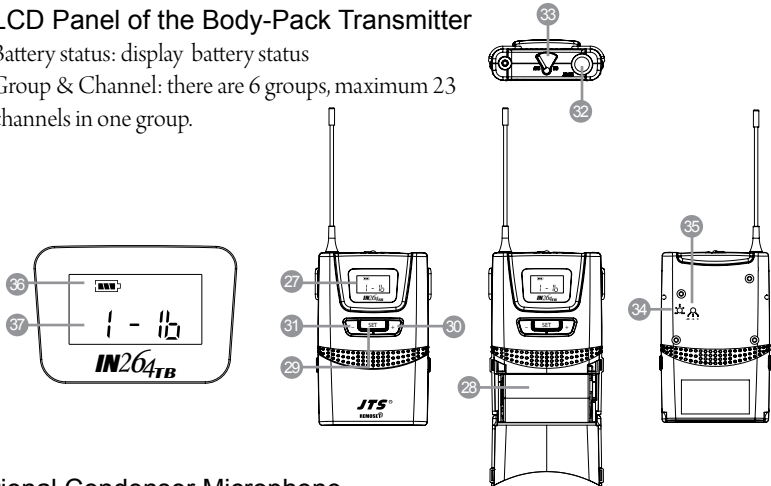

### 4-4 Optional Condenser Microphone

#### Lavaliere Microphone // CM-501 / CM-201 / CM-125

- 38 Clip
- 39 4 Pin Mini XLR
- 40 Windscreen

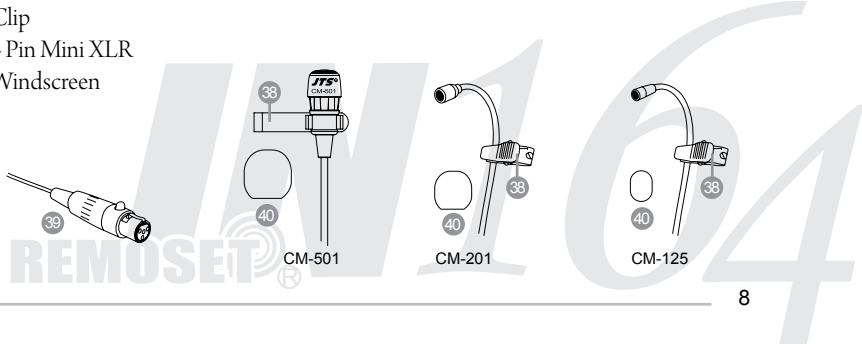

## Headset Microphone // CM-204 / CM-204U / CM-204UL / CM-225 / CX-504

- 41 Gooseneck
- 42 Headband
- 43 4 Pin Mini XLR
- 44 Windscreen

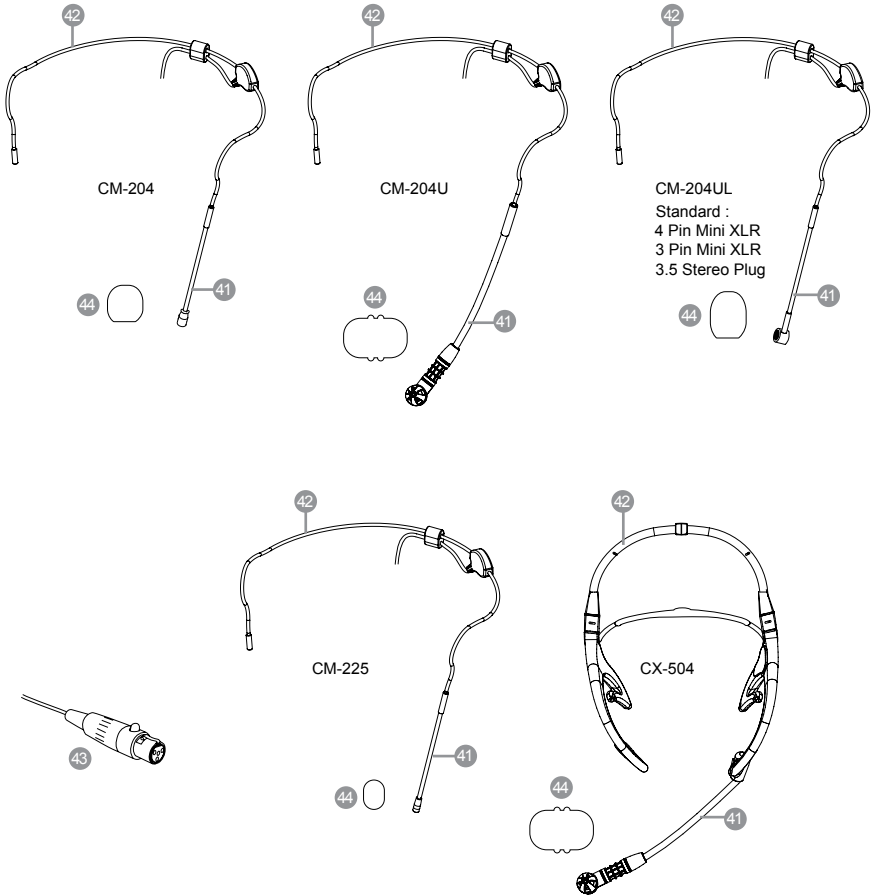

## Ear-hook Microphone // CM-801 CM-804i CM-8015 CM-825i

- 45 Boom
- 46 Adjustable Headband
- 47 Adjustable ear hook
- 48 Detchable Cable
- 49 Cable Clip
- 50 Windscreen
- 51 4 Pin Mini XLR
- 52 3 Pin Mini XLR **Option**
- 53 3.5 Stereo Plug **Option**

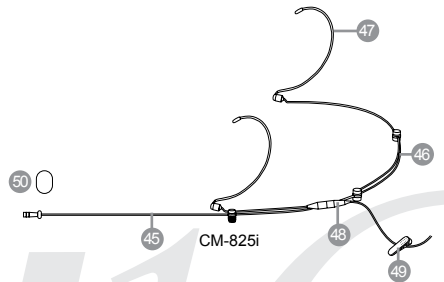
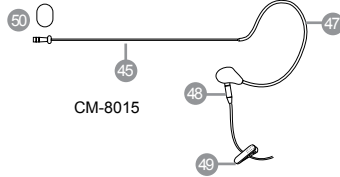
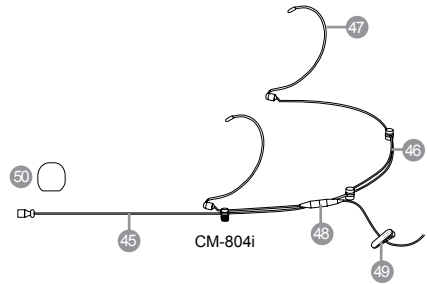
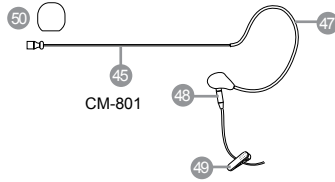
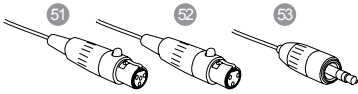

# Music Life INFINITY

Compatible Instrument Microphone // CX-500 / CX-500F / CX-520 /  
CX-508W / CX-516W

- 54 Gooseneck
- 55 Clip
- 56 Bracket
- 57 Volume Control
- 58 Windscreen
- 59 4 Pin Mini XLR

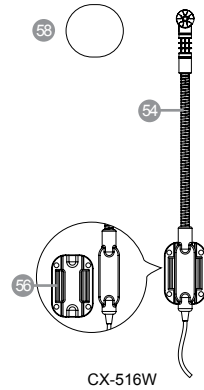
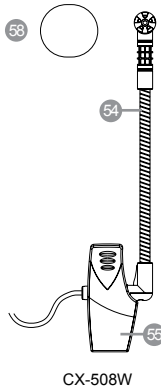
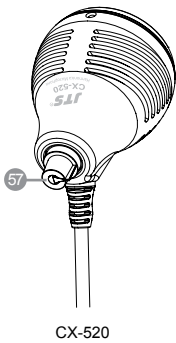
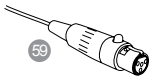
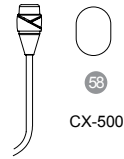

## 4-5 Accessories

- 60 AC/DC adaptor
  - A Switching Power Supply(100V~240V , 50~60Hz)
  - B Linear Power Supply (220V , 50Hz) **Option**
  - C Linear Power Supply (220V , 60Hz) **Option**
- 61 Screwdriver
- 62 DR-900 dual rack adaptor **Option**
- 63 RP-900 panel cover **Option**
- 64 AF output cable (with  $\Phi 6.3$  plug at both ends)
- 65 GC-80/GC-100 Guitar Cable **Option**
- 66 GC-80L/GC-100L Guitar Cable **Option**

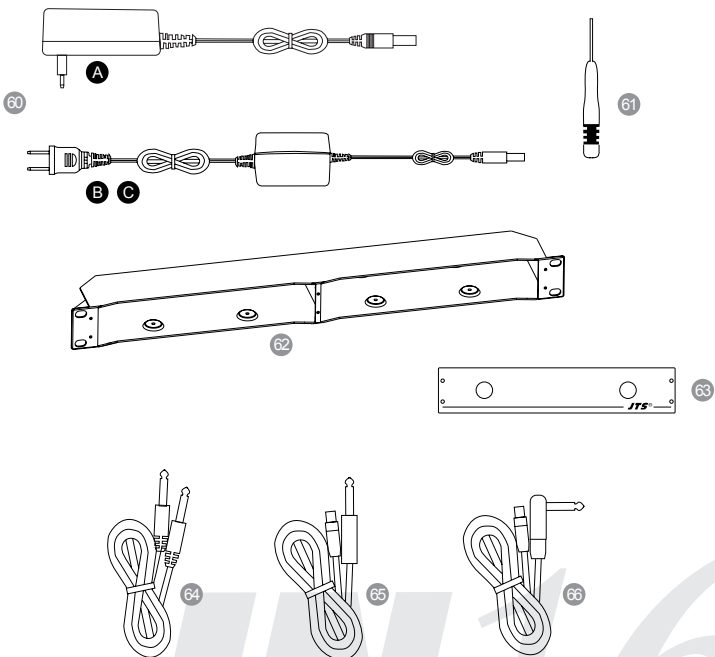

## 5. Connection

### 5-1 Receiver //

- (1) Connect to the subsequent unit (e.g. mixer, or amplifier)  
Connect one end of a proper AF cable to the AF Output ⑪ or Balanced XLR Output socket ⑫, then plug another end to the “MIC IN” input socket of a mixer or a amplifier (Step 1 of Figure 1)
- (2) Connect the power supply unit  
Plug in one end of AC/DC adaptor cable ⑤⑨ to Power Supply Jack ⑨ in the rear panel of receiver, and plug another end into an AC outlet (Step 2 of Figure 1)

### Caution

To prevent accidental disconnection of the plug of the power supply unit from the jack, lead the cable around the hook for strain relief. ⑩

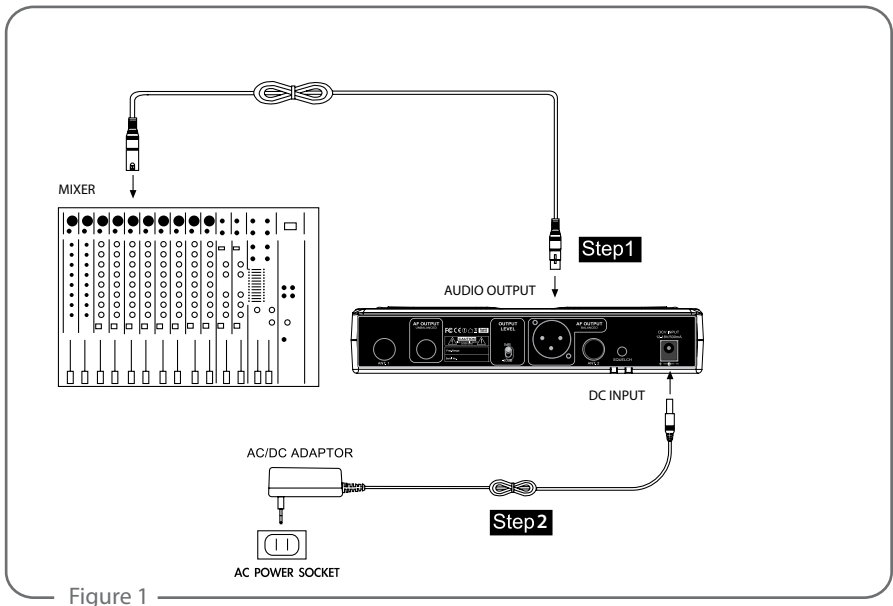

Figure 1



# 6. Operation

## 6-1 Set up the system

- (1) Turn on the power of the receiver  
Switch the “Power Switch” ❶ to “ON”. The “LCD Panel” ❷ and “REMOSET” Key ❸ will light up.
- (2) Turn on the power of the transmitter  
Press the “Power Switch” ❹ ❺ . The “LCD Display” ❻ ❼ will light up.
- (3) Mute Function ( for IN264TH )  
After the transmitter’s power is on, short pressing the “Power Switch “ will mute the microphone. Press the “Power Switch” again will re-activate the microphone.  
Notice: You have to hold the “Power Switch” for 3 seconds in order to turn off the transmitter.
- (4) Install the antennas in a vertical position

## 6-2 Set up ID code

In order to match one receiver to only one transmitter, IN164 is designed with “ID code”. If and only if both ID codes of a receiver and a transmitter match each other, the “REMOSET” function works. There are 100 ID codes available.

### Receiver

- (1) Press “Set” button ❹ for 3 seconds, LCD Panel will start flashing.
- (2) Press “Set” twice to enter “ID Code” setting window. (Figure 2)
- (3) Press “▲Up” ❷ or “▼Down” ❸” button to select a distinct ID code from “id 0” to “id 99”
- (4) After setting, press “Set” again to save the settings.

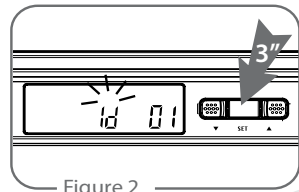

Figure 2

## Handheld and BodyPack transmitter

### ID code ON/OFF setting

- (1) Press “Set” button ⑳㉑ for 3 seconds, LCD Panel will start flashing.
- (2) Press “Set” a couple of times until “ID Code ON/OFF” setting window shows.
- (3) Press “▲Up ㉒㉓” or “▼Down ㉔㉕” button to select between “ID ON” and “ID OFF”.
- (4) After setting, press “Set” again to save the settings.

### Caution

When ID code is off (idOFF), the transmitter will accept any synchronization from any receiver.

### ID code selecting

- (1) Press “Set” button ⑳㉑ for 3 seconds, LCD Panel will start flashing.
- (2) Press “Set” a couple of times until “ID Code” setting window shows.
- (3) Press “▲Up ㉒㉓” or “▼Down ㉔㉕” button to select a distinct ID code from “id 0” to “id 99”. (Figure 3)
- (4) After setting, press “Set” again to save the settings.

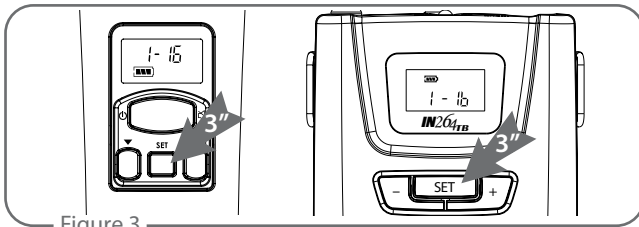
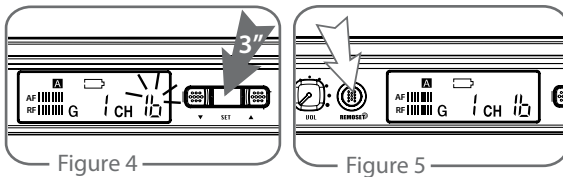

Figure 3

### 6-3 Synchronize the channel

- (1) Press “Set” button ④ for the receiver for 3 Seconds, the group (G) in the “Group & Channel” area ⑮ will flash. (Figure 4)
  - (2) Press “▲Up” ② or “▼Down” ③ button to select a desired group
  - (3) Press “Set” again and the Channel (CH) in the “Group & Channel” area will flash.
  - (4) Press “▲Up” or “▼Down” button to select a desired channel.
  - (5) After setting, press “Set” again to save the settings.
  - (6) Press “REMOSET” ⑥ to synchronize the channel of a transmitter. (Figure 5)
  - (7) If the channel of the transmitter fails to change, the “REMOSET” key will keep flashing.
- Notice 1: The transmitter has to be set to “synchronization on (SYnOn)” in order to allow the receiver to synchronize.(Handheld and body Pack Setting List p.17 )
- Notice 2 : When setting the channel, system will automatically avoid the channel used by the other channel.



### 6-4 Check system status

- (1) Antenna Status: the receiver will automatically select an antenna with stronger signal reception and highlight that antenna ⑮ (Figure 6)
- (2) Battery indicator: the receiver's battery indicator will show the same gauge as the transmitters. If the transmitter is under low battery status, the receiver LCD backlight will be on amber.

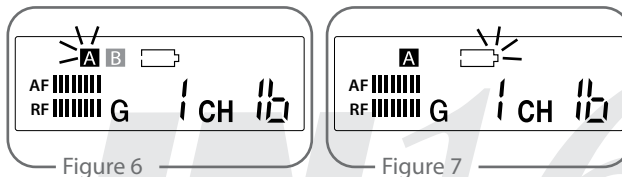

## 6-5 Manual select channel

### Receiver

- (1) Press “Set” button ④ for 3 seconds, the group (G) in the “Group & Channel” area will flash. (Figure 8)
- (2) Press “▲Up” ② or “▼Down” ③ button to select a desired group.
- (3) Press “Set” again and the Channel(CH) in the “Group & Channel” area will flash.
- (4) Press “▲Up” or “▼Down” button to select a desired channel.
- (5) After setting, press “Set” again to save the setting.

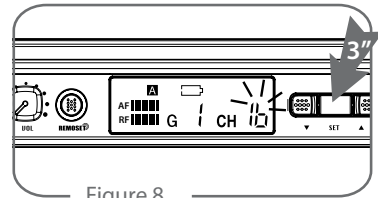

Figure 8

### Handheld and BodyPack transmitter

- (1) Press “Set” button ②① ②⑨ button for 3 seconds, the group (G) will flash. (Figure 9)
- (2) Press “▲Up” ②② ③① or “▼Down” ②③ ③① button to select a desired group.
- (3) Press “Set” again and the Channel (CH) will flash.
- (4) Press “▲Up” or “▼Down” button to select a desired channel.
- (5) After setting, press “Set” again to save the setting.

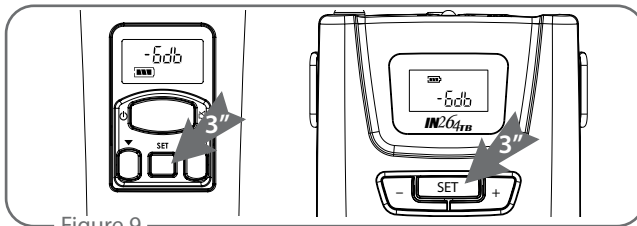

Figure 9

## 6-6 Lock ON Function

### Receiver

- (1) Press “Set” button ④ for 3 seconds to enter setting window
- (2) Press “Set” again until the Lock setting window shows. (Figure 10)

**Notice: Original setting is lock off (Lo OF).**

- (3) Press “▲Up ②” or “▼Down ③” button to select the mode between “Lock On” and “Lock off”.
- (4) After setting, press “Set” again to save the setting.

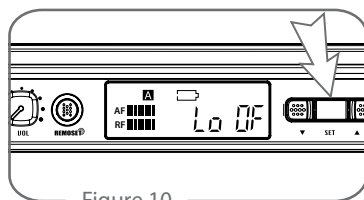

Figure 10

### To release the “Lock ON”

- (1) Press “Set” button ④ for 2 seconds.
- (2) Press “▼Down ③” to select “Lock OFF”.
- (3) Press “Set” to store.

### Handheld and BodyPack transmitter

- (1) Press “Set” button ②① ②⑨ for 3 seconds to enter setting window. (Figure 11)
- (2) Press “Set” again until the Lock setting window shows.

**Notice: Original setting is lock off (Lo OF).**

- (3) Press “▲Up ②② ③①” or “▼Down ②③ ③①” button to select the mode between “Lock On” and “Lock off”.
- (4) After setting, press “Set” again to save the setting.

### To release the “Lock ON”

- (1) Press “Set” button ④ for 2 seconds.
- (2) Press “▼Down ③” to select “Lock OFF”.
- (3) Press “Set” to store.

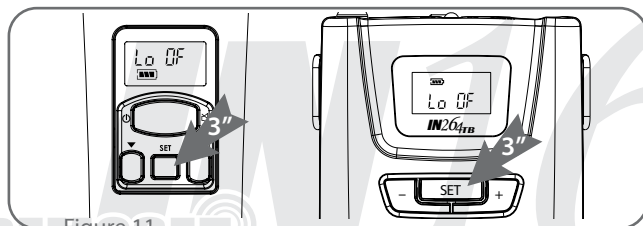

Figure 11

## 6-7 Adjust the sensitivity of the microphone

### Handheld transmitter

- (1) Press "Set" button **21 29** for 3 seconds to enter setting window. (Figure 12)
- (2) Short press "Set" until the sensitivity setting window shows.
- (3) Press "▲Up **22 30**" or "▼Down **23 31**" button to select the sensitivity among 0db, -3db, -6db, -9db, -12db, -15db, -18db and -21db.
- (4) After setting, press "Set" again to save the setting.

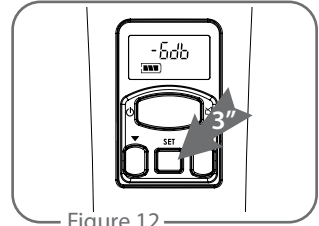
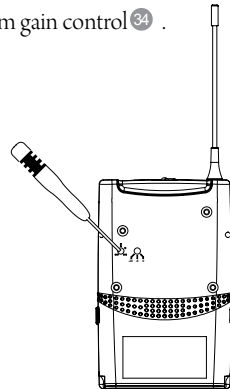

Figure 12

### BodyPack transmitter

- (1) Use the screwdriver **29** included to adjust the sensitivity from gain control **34**.  
(clockwise is "increase")
- (2) If further adjustment is needed please adjust the pad.



## 6-8 Adjust the transmitting power

### Handheld/Body Pack Transmitter

- (1) Push the "Set" button **21 29** several times until the "rF Lo" or "rF Hi" flashes.
- (2) Then push "▲Up **22 30**" to choose "Hi" for high transmitting power and push "▼Down **23 31**" to choose "Lo" for low transmitting power.
- (3) Selectable transmission power between 10mW & 50mW.
- (4) Push the "Set" again to save the setting.

## Handheld and Body Pack Setting List

Sensitivity Settings	<p>0db -3db -6db -9db -12db -15db -18db -21db</p>	0 dB is the highest sensitivity
Synchronization ON/OFF	<p>SynOn SynOff</p>	<p>"On" means "REMOSET" function always opens; "Off" means "REMOSET" function is turned off</p>
ID code ON/OFF	<p>idOff idOn</p>	When ID code is OFF (id OFF), the transmitter will accept any synchronization from any IN164R.
ID code select	id 0 ~ id 99	There are 100 ID codes.
Lock ON	<p>LocOff LocOn</p>	<p>button unlock button lock</p>

## 6-9 Installation of Condenser Microphones

### (1) Lavalier microphone

Attach lavalier microphone to a tie, lapel, where is suitable for sound pick-up. Plug the connector into input socket on the body-pack transmitter.

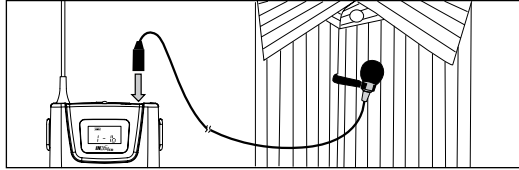

### (2) Headset microphone

Put the headband behind your head, and fix the temples on your ears as shows, then adjust the gooseneck to have best miking. Plug the connector into input socket on the body-pack transmitter.

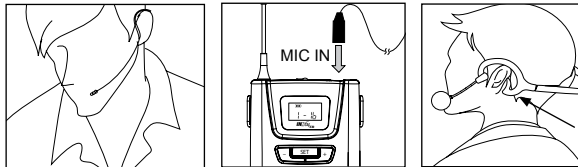

### (3) Instrument Microphones

The system is compatible with JTS various instrument microphones. For detail please refer to user's manuals of these microphones.

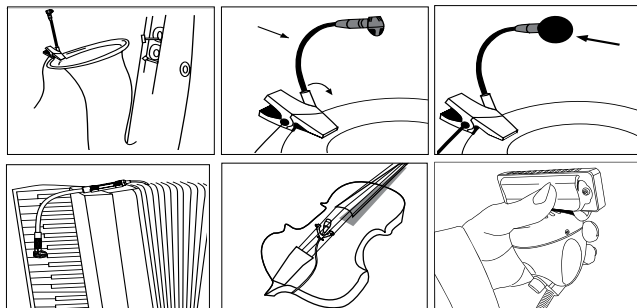



#### (4) Ear-hook Microphone

##### 1. Lightweight Dual Ear Hook Microphone

Try on whether the headset is fit.

Adjust the headband to a suitable width.

Tighten or loosen the curve of the ear-hook by twisting the loop or expanding it.

Curve and bend the boom to fit your face.

Attach the detachable cable to a suitable place by a cable clip.

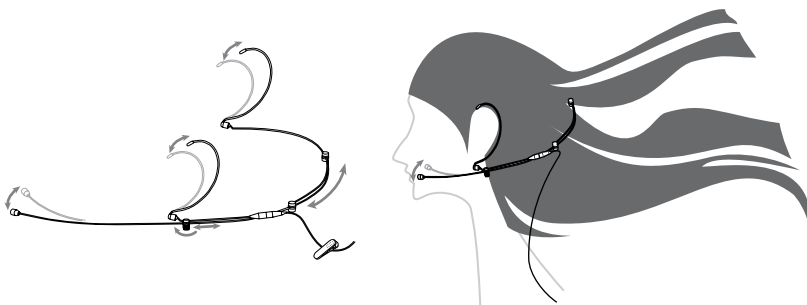

##### 2. Lightweight Single Ear Hook Microphone

Try on whether the original curve is tight or loose.

Re-try and push the fixed curve against your earlobe.

Curve and Bend the boom to fit your face.

Attach the detachable cable to a suitable place by a cable clip.

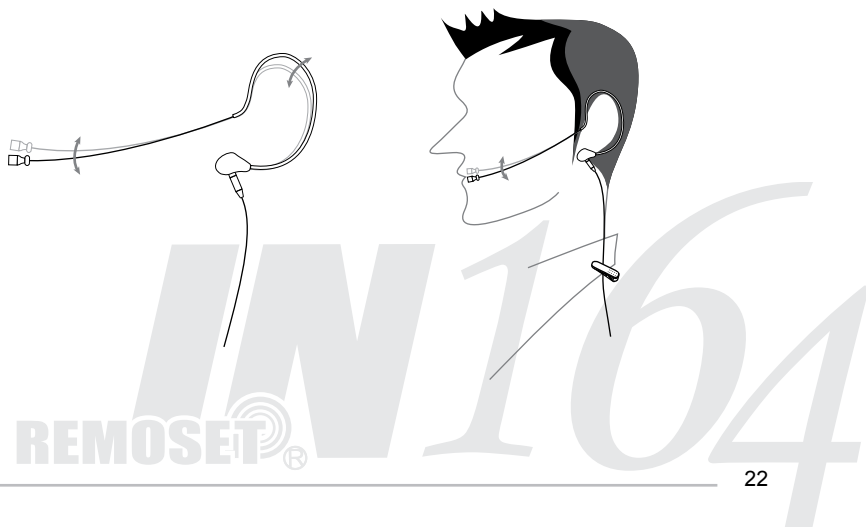

## 7. Recommendation

- (1) In order to achieve the optimum reception condition and also extend the operating distance, please leave a “open space” between the receiver and transmitter.
- (2) Keep the devices away from the metal objects or any interference sources, at least 50 cm.
- (3) To avoid the feed-back effect, don't leave the mic. to aim at the speakers directly.
- (4) For best pick-up pattern, please hold the middle of the mic. body.
- (5) Remove batteries from the battery compartment when the transmitter will not be used for a long time.
- (6) When you need to replace the batteries, please replace both batteries at the same time with new ones.

## 8. Important Notice

- (1) JTS offers wireless systems in a selection of bands that conform to the different government regulations of specific nations or geographic regions. These regulations help limit radio frequency (RF) interference among different wireless devices and prevent interference with local public communications channels, such as television and emergency broadcasts.
- (2) For information on bands available in your area, consult your local dealer or phone JTS. More information is also available at JTS's website ([www.jts.com.tw](http://www.jts.com.tw)).
- (3) This Radio apparatus may be capable of operating on some frequencies not authorized in your region. Please contact your national authority to obtain information on authorized frequencies and RF power levels for wireless microphone products.

