

Photometric Test Report

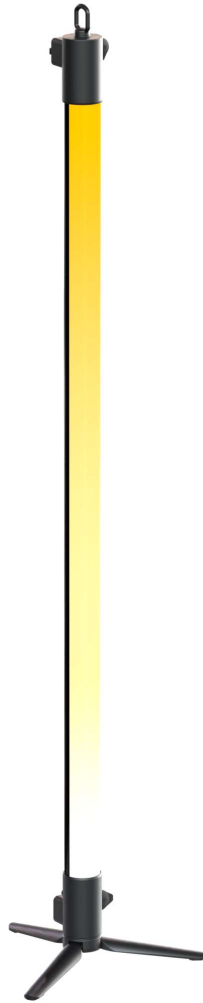

ECLSOFTTUBE100

100 cm, battery-powered soft tube for Film & TV
IP rated with an RGB+Warm White source
wireless or wired

CONTENTS

Table of contents	2
Testing process	3
Color preset Full on	4
Color preset Red	7
Color preset Green	10
Color preset Blue	13
Color preset White	16
Color temperature 2800K	19
Color temperature 3200K	24
Color temperature 4000K	29
Color temperature 5600K	34
Color temperature 6000K	39

TESTING PROCESS

Prolights has its own optical testing laboratory in order to provide accurate photometric reports for its lighting products. The testing laboratory contains certain variety of precise lighting measurement systems that ensure an optimal reading of all the characteristic parameters of the lighting devices. All measurements are made at a controlled room temperature of 20°C without any external light sources. This photometric report is obtained through the data measured by a high precision measurement system and analyzed by a dedicate software.

Prolights measurement instrument

Prolights measurement instrument is a complete measurement system for any light source. It's equipped with two-axis goniometer, that enables to measure the full 3D distribution field of the light source. This instrument measures the light intensity, the beam angle and the most significative colors parameters, like color temperature, spectral distribution, CRI, CQS, TM-30 with a very high accuracy rate.

Please Note: All measurements are made with light source at operating temperature. Before starting the measurement, the instrument analyzes the process of the light source during the heating phase. The measuring process of all the parameters begins only when the light emission is stable, that is with a variation of less than 0.5% in a 15 minutes time frame.

Prolights measurement software

The software provides user friendly interface for the operator who does the measurements, and it also analyzes and processes all the collected data by the instrument. With this software it is possible to see the measured data in real-time and it is possible to examine all the measured data and graphics afterwards as well. All information is collected in a specific Prolights template, and the software creates also IES and LDT files, which are widely used to transfer the photometric data, and to develop lighting system.

Additionally, the fixtures are rechecked using various hand-held instruments like Sekonic C-700 and Gossen Mavospec Base, this is done to ensure, that the data in the photometric report are as accurate as possible.

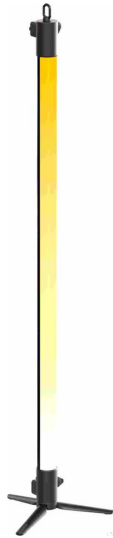

Total lumen output:

2386 lm

Peak candela output:

642 cd

PRODUCT NAME:

ECLSOFTTUBE100

MEASURAMENT CONDITIONS:

Beam angle:

Native

Target:

Full On

Operator:

Paolo Carvone

Date and time:

24/10/2022 18:00:49

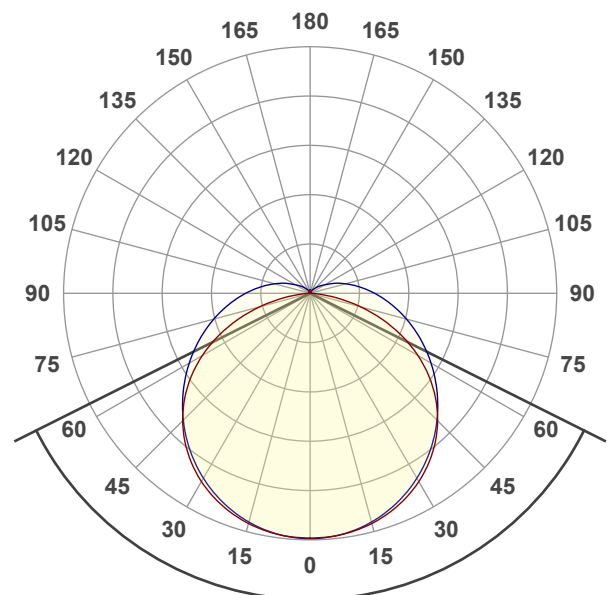

Beam angle 50%: 126,8°

Field angle 10%: 194,6°

Cut off angle 2.5%: 225,1°

Spectra

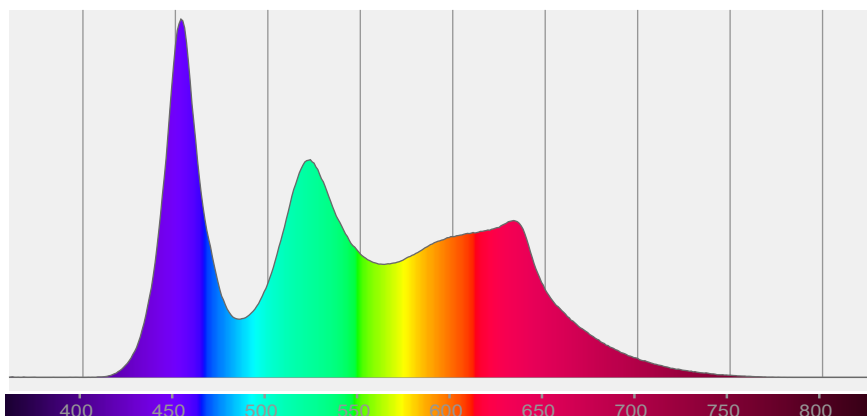

BEAM DETAILS



Beam angle 50%	Field angle 10%	Cut off angle 2,5%	Intensity ratio in 120° cone	Intensity ratio in 90° cone
126,8°	194,6°	225,1°	65,3%	43,0%

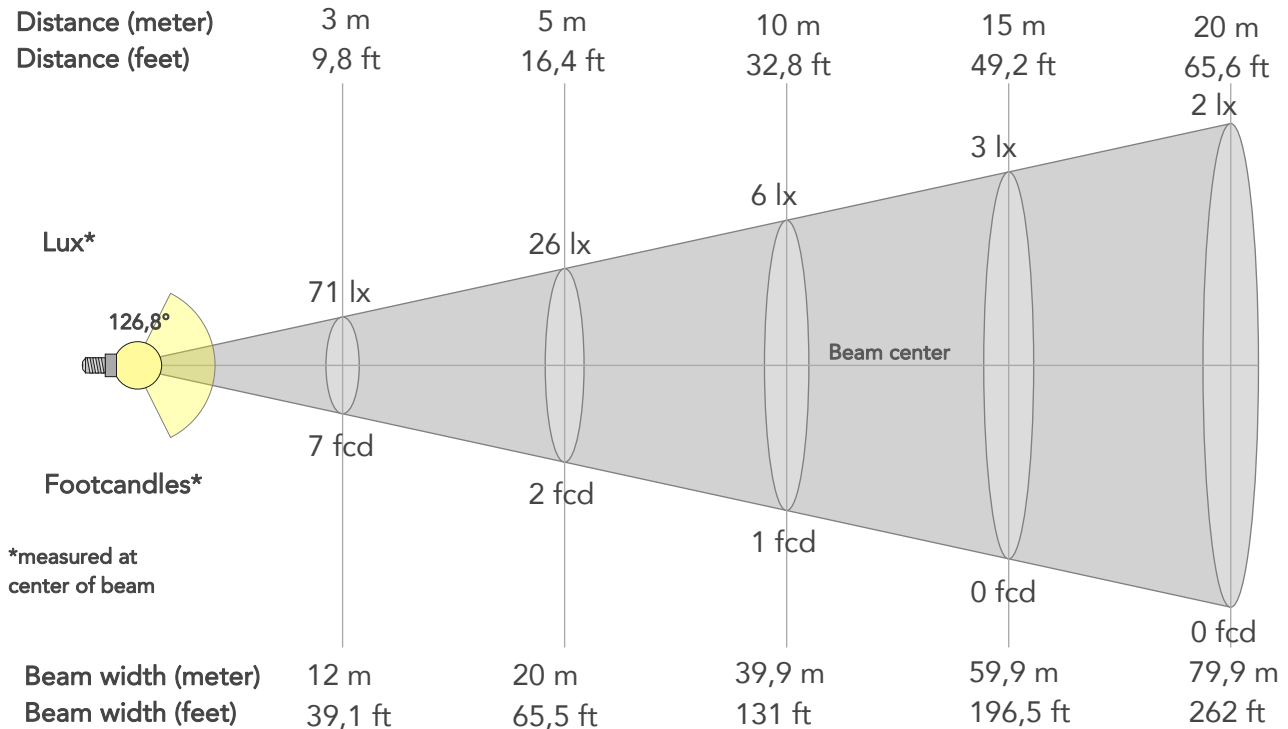

BEAM INTENSITIES AND WIDTHS

Distance	1m	2m	3m	4m	5m	7,5m	10m	15m	20m	25m	30m	40m	50m
Distance	3,3ft	6,6ft	9,8ft	13,1ft	16,4ft	24,6ft	32,8ft	49,2ft	65,6ft	82ft	98,4ft	131,2ft	164ft
Lux	642lx	161lx	71lx	40lx	26lx	11lx	6lx	3lx	2lx	1lx	1lx	0lx	0lx
Footcand.	60fcd	15fcd	7fcd	4fcd	2fcd	1fcd	1fcd	0fcd	0fcd	0fcd	0fcd	0fcd	0fcd
Beam wid.	4m	8m	12m	16m	20m	29,9m	39,9m	59,9m	79,9m	99,8m	119,8m	159,7m	199,7m
Beam wid.	13,2ft	26,4ft	39,1ft	52,3ft	65,5ft	98,2ft	131ft	196,5ft	262ft	327,4ft	392,9ft	523,9ft	654,9ft

LINEAR DISTRIBUTION DIAGRAM

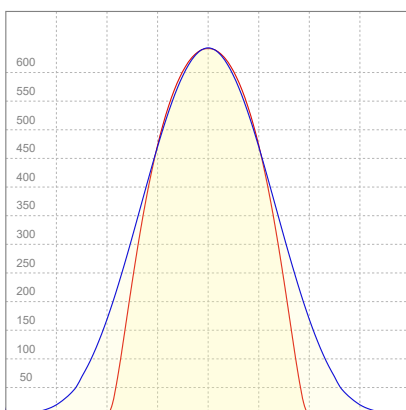

ELECTRICAL SPECIFICATIONS

Input voltage	Input current	Input power	Effeciency
225V	0,256A	55W	43lm/W

Power FC
0,96

ISO CANDELA DIAGRAM

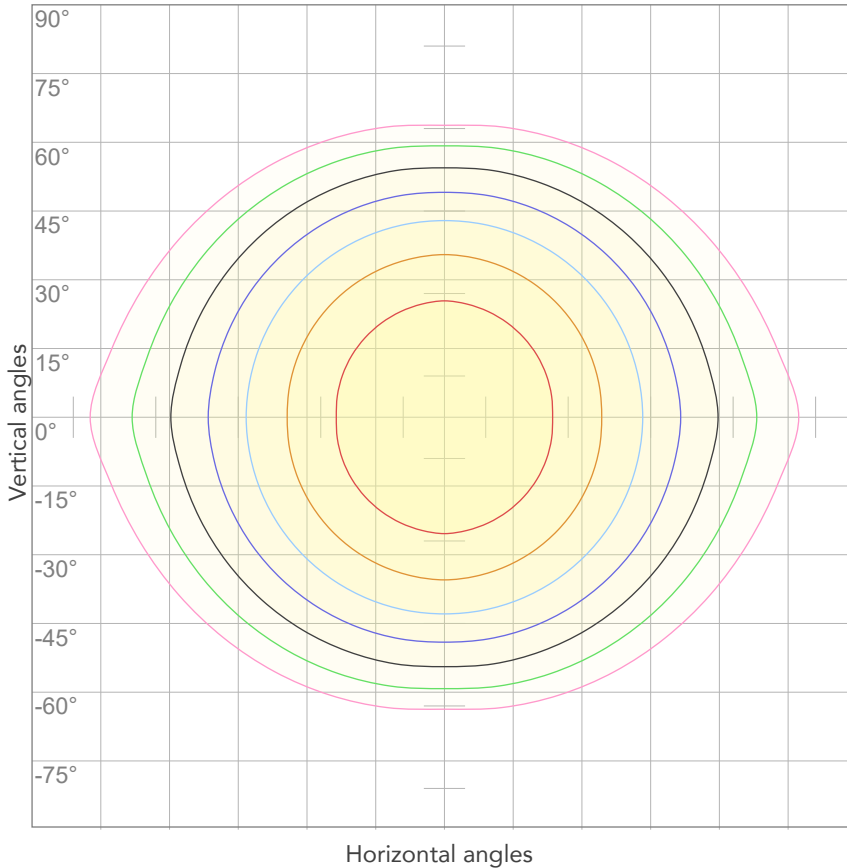

10%	64 cd
20%	128 cd
30%	193 cd
40%	257 cd
50%	321 cd
60%	385 cd
70%	449 cd
80%	514 cd

Conditions:

Number of c-planes: 4
Candela at center: 642 cd

ISO LUX DIAGRAM

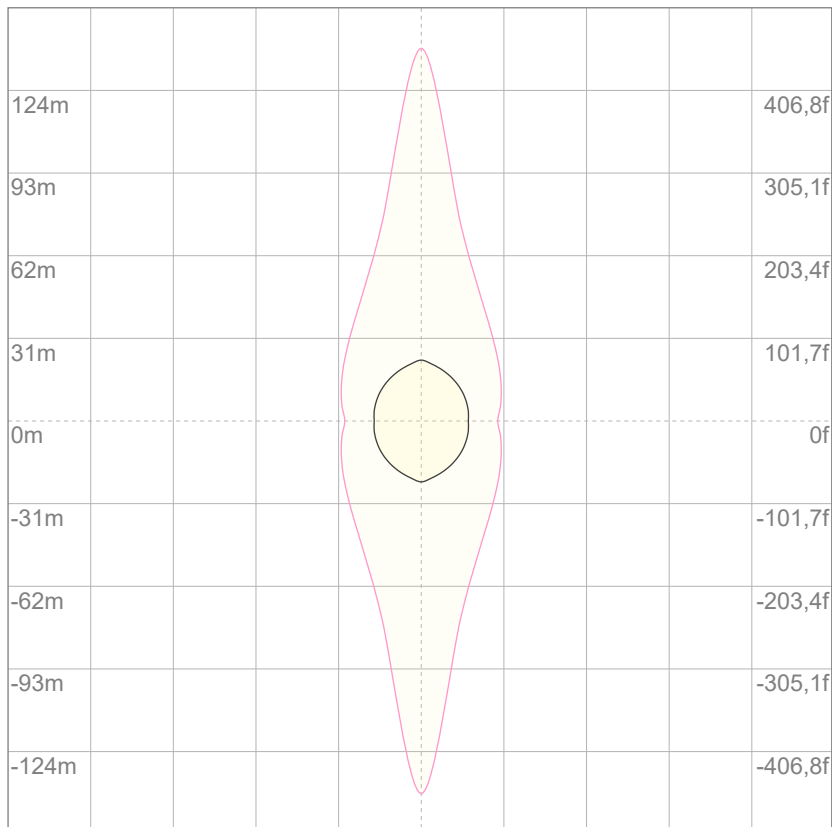

3%	0,193 lx
5%	0,321 lx
10%	0,642 lx
30%	1,93 lx
50%	3,21 lx

Conditions:

Number of c-planes: 4
Lux at center: 6,42 lx

Lux distribution on a surface when lamp is mounted at 10 meters from the surface.

Mounting height: 10 meters (33 feet)

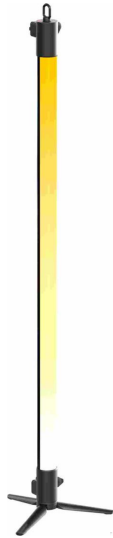

Total lumen output:

390 lm

Peak candela output:

103 cd

PRODUCT NAME:

ECLSOFTTUBE100

MEASURAMENT CONDITIONS:

Beam angle:

Native

Target:

Red

Operator:

Paolo Carvone

Date and time:

24/10/2022 18:10:22

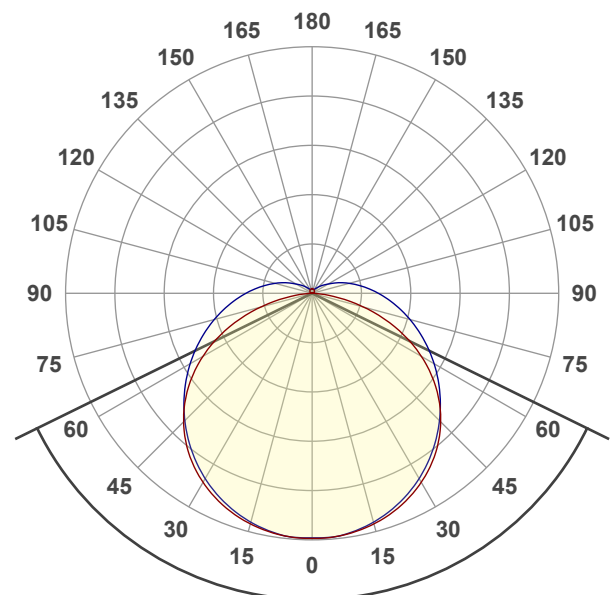

Beam angle 50%: 127,7°

Field angle 10%: 196,1°

Cut off angle 2.5%: 230°

Spectra

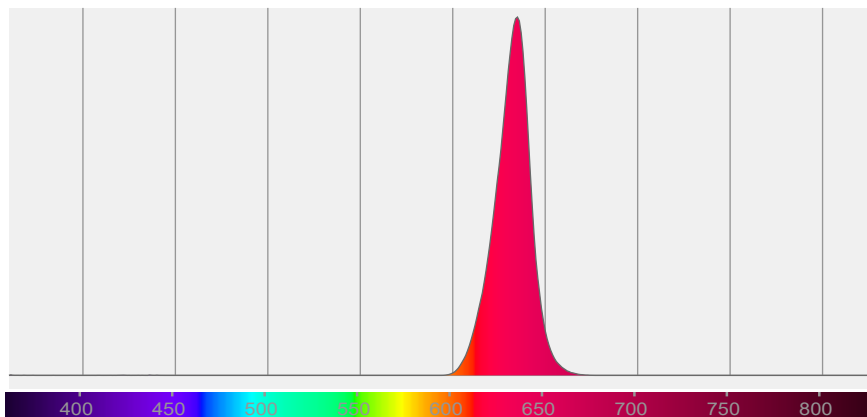

BEAM DETAILS



Beam angle 50%	Field angle 10%	Cut off angle 2,5%	Intensity ratio in 120° cone	Intensity ratio in 90° cone
127,7°	196,1°	230°	64,5%	42,4%

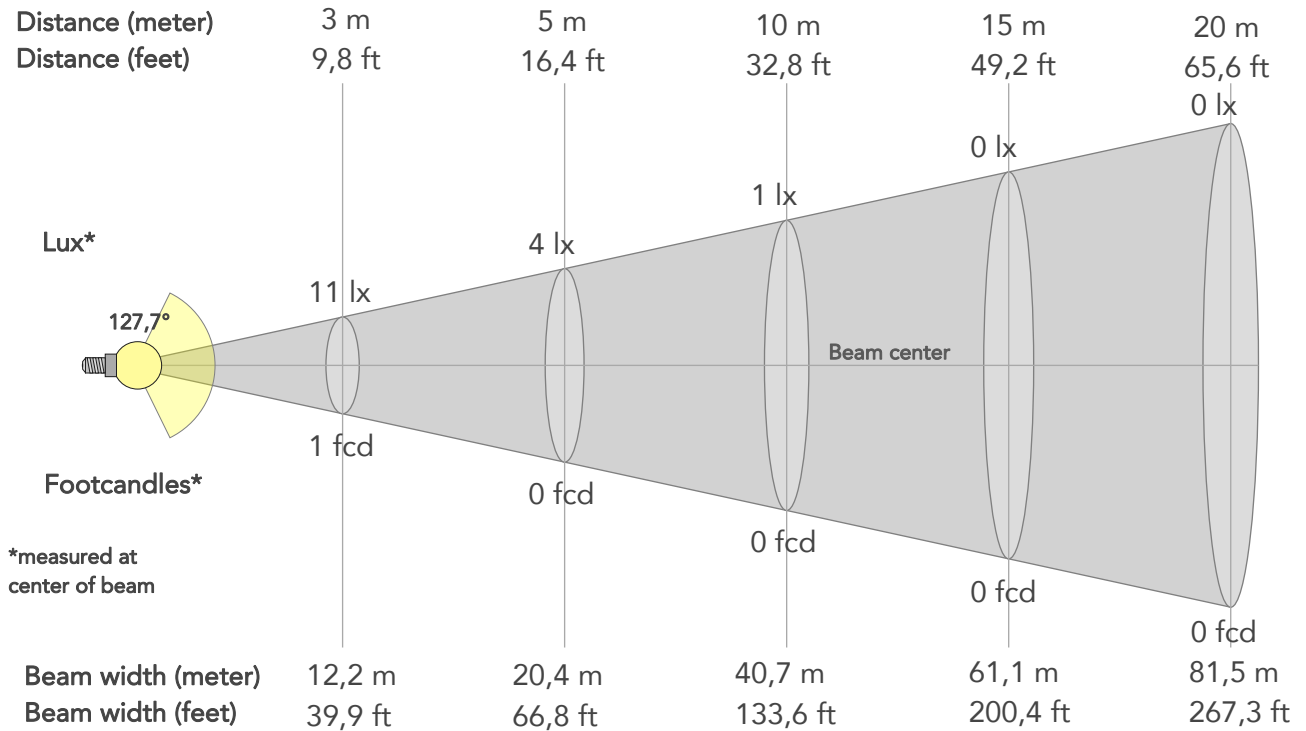

BEAM INTENSITIES AND WIDTHS

Distance	1m	2m	3m	4m	5m	7,5m	10m	15m	20m	25m	30m	40m	50m
Distance	3,3ft	6,6ft	9,8ft	13,1ft	16,4ft	24,6ft	32,8ft	49,2ft	65,6ft	82ft	98,4ft	131,2ft	164ft
Lux	103lx	26lx	11lx	6lx	4lx	2lx	1lx	0lx	0lx	0lx	0lx	0lx	0lx
Footcand.	10fcd	2fcd	1fcd	1fcd	0fcd	0fcd	0fcd	0fcd	0fcd	0fcd	0fcd	0fcd	0fcd
Beam wid.	4,1m	8,1m	12,2m	16,3m	20,4m	30,6m	40,7m	61,1m	81,5m	101,9m	122,2m	163m	203,7m
Beam wid.	13,4ft	26,9ft	39,9ft	53,4ft	66,8ft	100,2ft	133,6ft	200,4ft	267,3ft	334,1ft	400,9ft	534,5ft	668,1ft

LINEAR DISTRIBUTION DIAGRAM

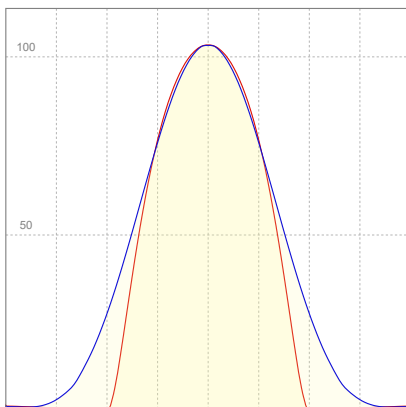

ELECTRICAL SPECIFICATIONS

Input voltage	Input current	Input power	Effeciency
225V	0,167A	29,3W	13lm/W

Power FC
0,78

ISO CANDELA DIAGRAM

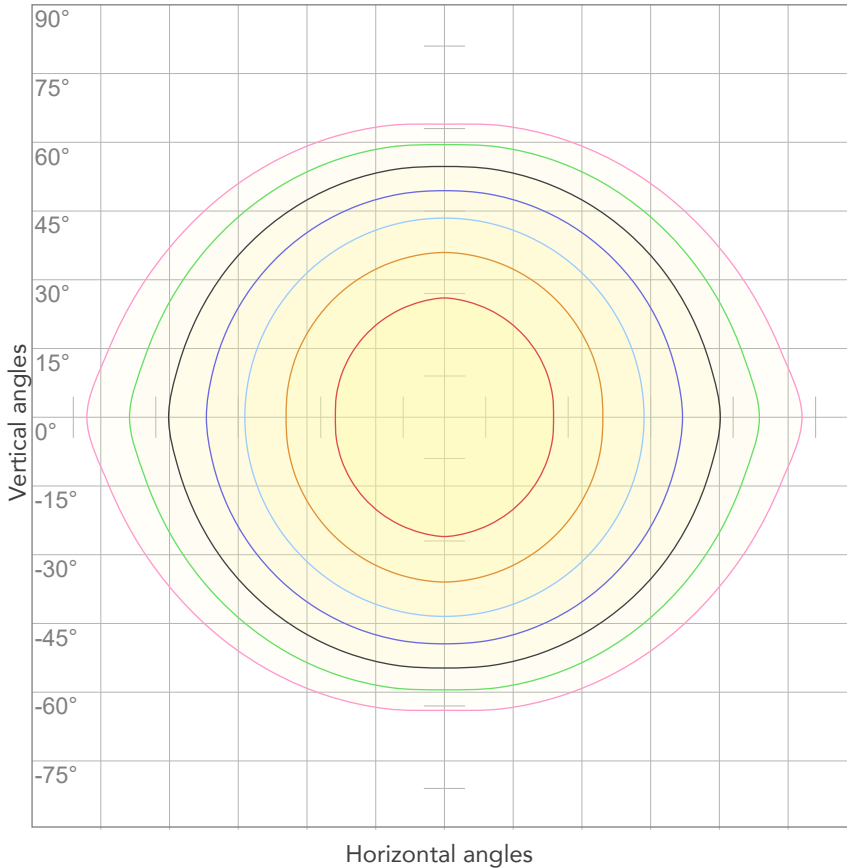

10%	10 cd
20%	21 cd
30%	31 cd
40%	41 cd
50%	52 cd
60%	62 cd
70%	72 cd
80%	83 cd

Conditions:

Number of c-planes: 4

Candela at center: 103 cd

ISO LUX DIAGRAM

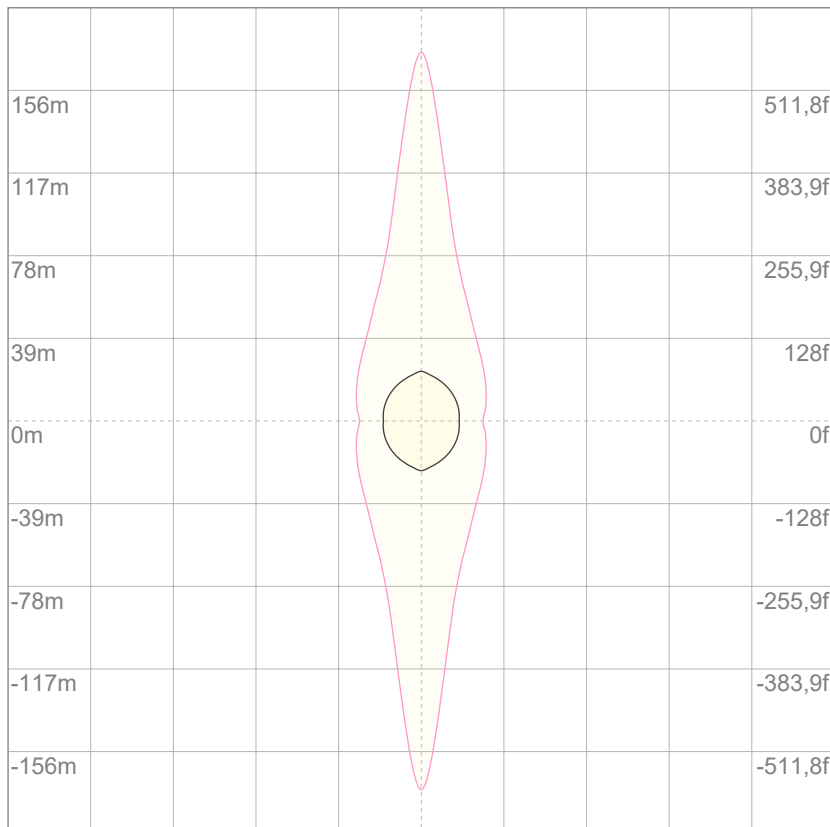

3%	31,0m lx
5%	51,6m lx
10%	0,103 lx
30%	0,310 lx
50%	0,516 lx

Conditions:

Number of c-planes: 4

Lux at center: 1,03 lx

Lux distribution on a surface when lamp is mounted at 10 meters from the surface.

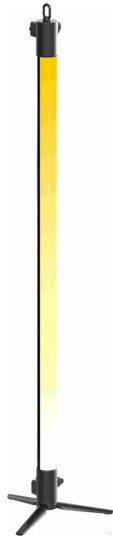

Total lumen output:

1124 lm

Peak candela output:

303 cd

PRODUCT NAME:

ECLSOFTTUBE100

MEASURAMENT CONDITIONS:

Beam angle:

Native

Target:

Green

Operator:

Paolo Carvone

Date and time:

24/10/2022 18:13:43

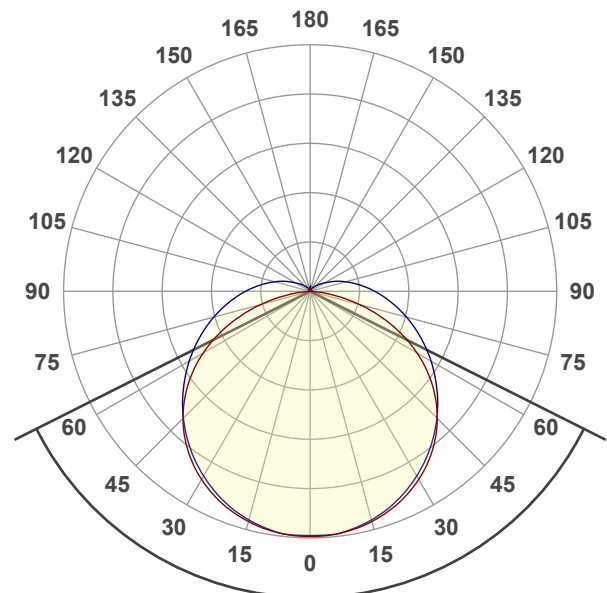

Beam angle 50%: 126,6°

Field angle 10%: 194,3°

Cut off angle 2.5%: 224,4°

Spectra

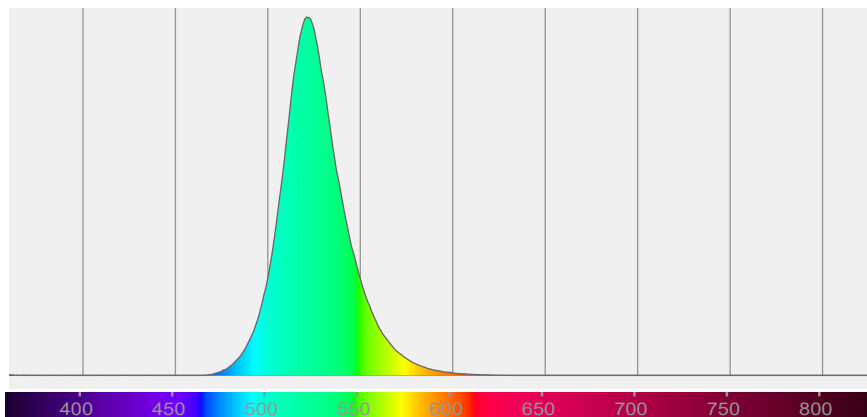

BEAM DETAILS



Beam angle 50%	Field angle 10%	Cut off angle 2,5%	Intensity ratio in 120° cone	Intensity ratio in 90° cone
126,6°	194,3°	224,4°	65,4%	43,0%

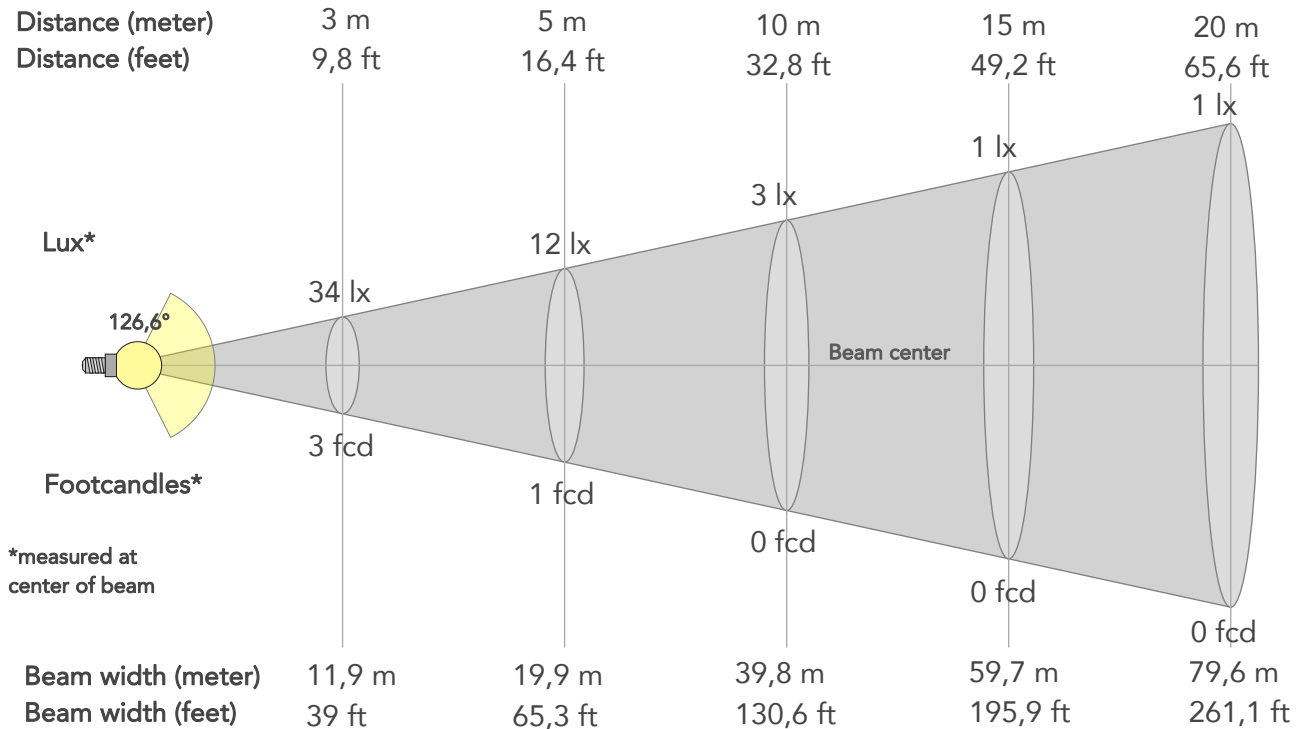

BEAM INTENSITIES AND WIDTHS

Distance	1m	2m	3m	4m	5m	7,5m	10m	15m	20m	25m	30m	40m	50m
Distance	3,3ft	6,6ft	9,8ft	13,1ft	16,4ft	24,6ft	32,8ft	49,2ft	65,6ft	82ft	98,4ft	131,2ft	164ft
Lux	303lx	76lx	34lx	19lx	12lx	5lx	3lx	1lx	1lx	0lx	0lx	0lx	0lx
Footcand.	28fcd	7fcd	3fcd	2fcd	1fcd	1fcd	0fcd	0fcd	0fcd	0fcd	0fcd	0fcd	0fcd
Beam wid.	4m	8m	11,9m	15,9m	19,9m	29,9m	39,8m	59,7m	79,6m	99,5m	119,4m	159,2m	199m
Beam wid.	13,1ft	26,3ft	39ft	52,1ft	65,3ft	97,9ft	130,6ft	195,9ft	261,1ft	326,4ft	391,7ft	522,3ft	652,9ft

LINEAR DISTRIBUTION DIAGRAM

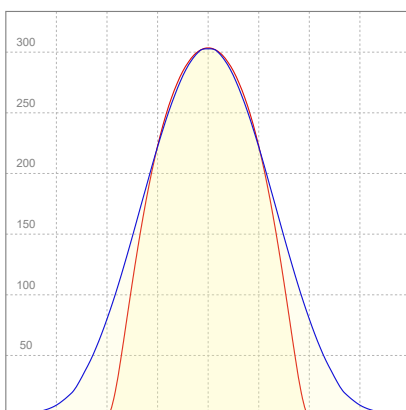

ELECTRICAL SPECIFICATIONS

Input voltage	Input current	Input power	Effeciency
225V	0,158A	29,6W	38lm/W

Power FC
0,83

ISO CANDELA DIAGRAM



10%	30 cd
20%	61 cd
30%	91 cd
40%	121 cd
50%	151 cd
60%	182 cd
70%	212 cd
80%	242 cd

Conditions:

Number of c-planes: 4
Candela at center: 303 cd

ISO LUX DIAGRAM

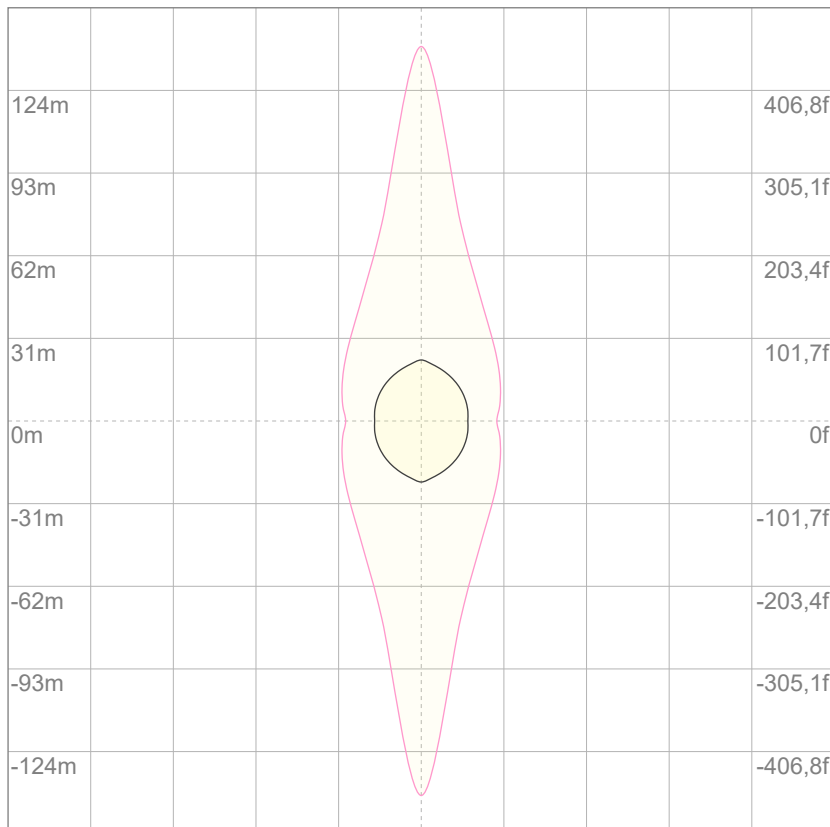

3%	90,8m lx
5%	0,151 lx
10%	0,303 lx
30%	0,908 lx
50%	1,51 lx

Conditions:

Number of c-planes: 4
Lux at center: 3,03 lx

Lux distribution on a surface when lamp is mounted at 10 meters from the surface.

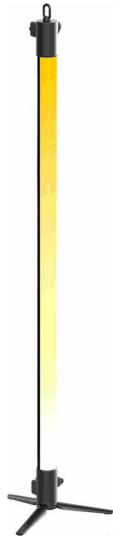

Total lumen output:

159 lm

Peak candela output:

43,4 cd

PRODUCT NAME:

ECLSOFTTUBE100

MEASURAMENT CONDITIONS:

Beam angle:

Native

Target:

Blue

Operator:

Paolo Carvone

Date and time:

24/10/2022 18:16:46

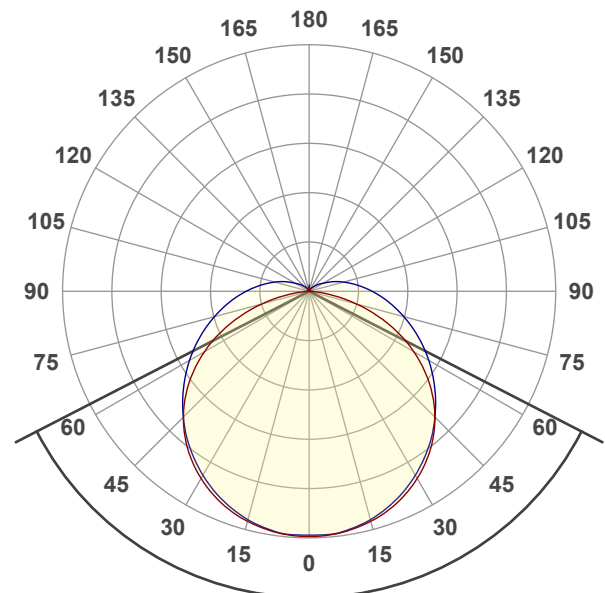

Beam angle 50%: 125,5°

Field angle 10%: 193,4°

Cut off angle 2.5%: 223,8°

Spectra

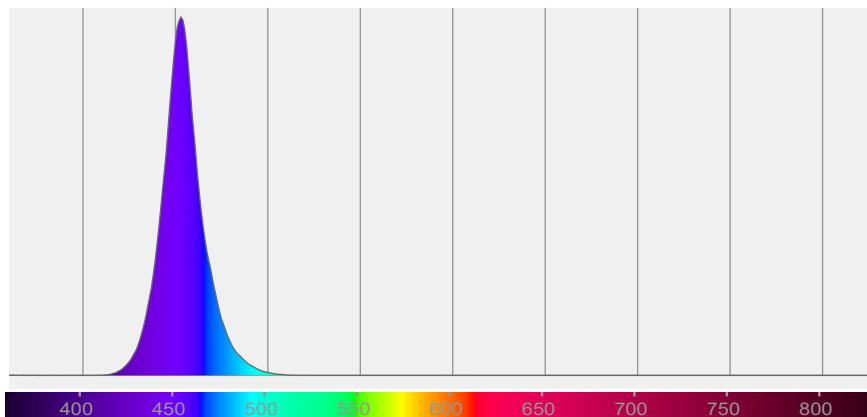

BEAM DETAILS



Beam angle 50%	Field angle 10%	Cut off angle 2,5%	Intensity ratio in 120° cone	Intensity ratio in 90° cone
125,5°	193,4°	223,8°	65,7%	43,4%

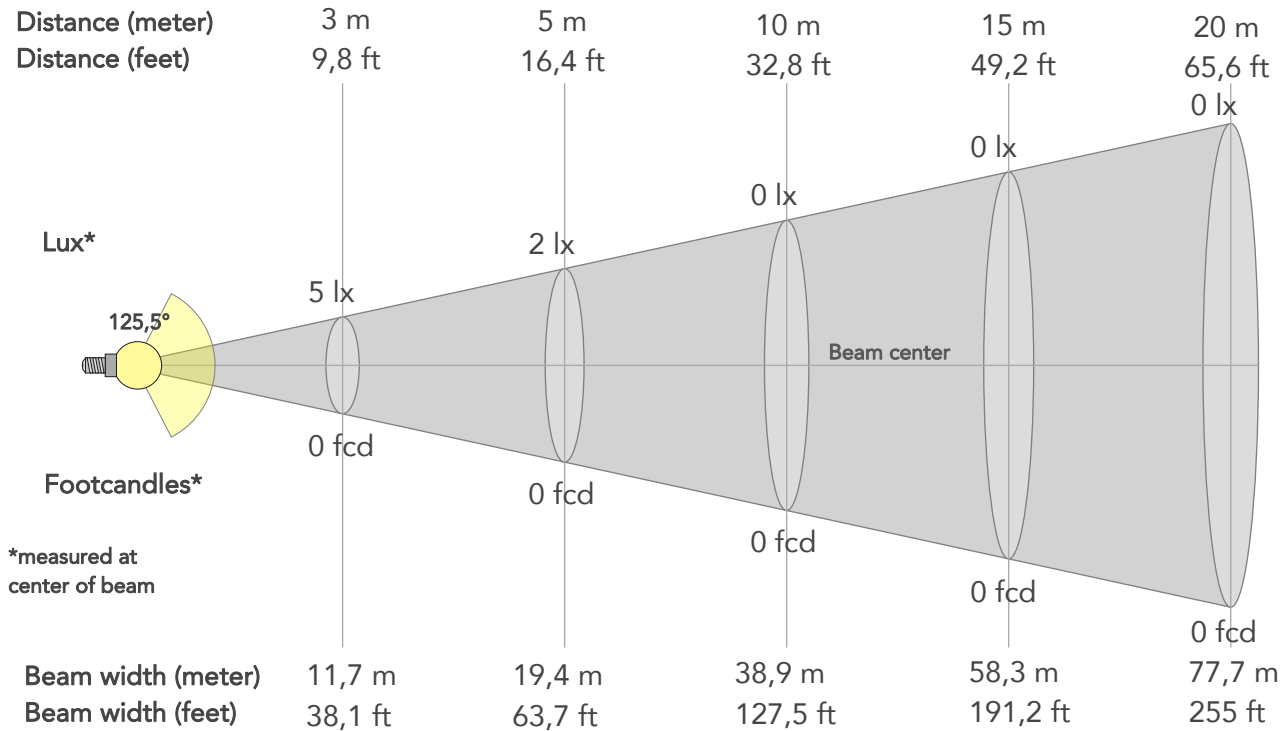

BEAM INTENSITIES AND WIDTHS

Distance	1m	2m	3m	4m	5m	7,5m	10m	15m	20m	25m	30m	40m	50m
Distance	3,3ft	6,6ft	9,8ft	13,1ft	16,4ft	24,6ft	32,8ft	49,2ft	65,6ft	82ft	98,4ft	131,2ft	164ft
Lux	43lx	11lx	5lx	3lx	2lx	1lx	0lx	0lx	0lx	0lx	0lx	0lx	0lx
Footcand.	4fcd	1fcd	0fcd	0fcd	0fcd	0fcd	0fcd	0fcd	0fcd	0fcd	0fcd	0fcd	0fcd
Beam wid.	3,9m	7,8m	11,7m	15,5m	19,4m	29,2m	38,9m	58,3m	77,7m	97,2m	116,6m	155,5m	194,4m
Beam wid.	12,8ft	25,7ft	38,1ft	50,9ft	63,7ft	95,6ft	127,5ft	191,2ft	255ft	318,7ft	382,5ft	510ft	637,5ft

LINEAR DISTRIBUTION DIAGRAM

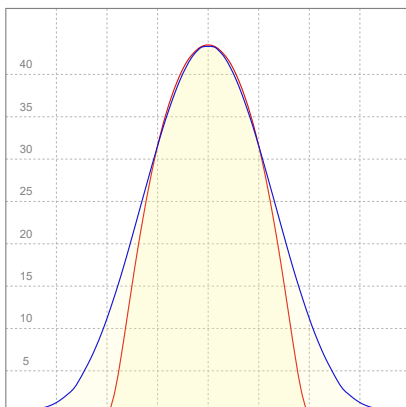

ELECTRICAL SPECIFICATIONS

Input voltage	Input current	Input power	Effeciency
225V	0,230A	23,9W	7lm/W

Power FC
0,46

ISO CANDELA DIAGRAM

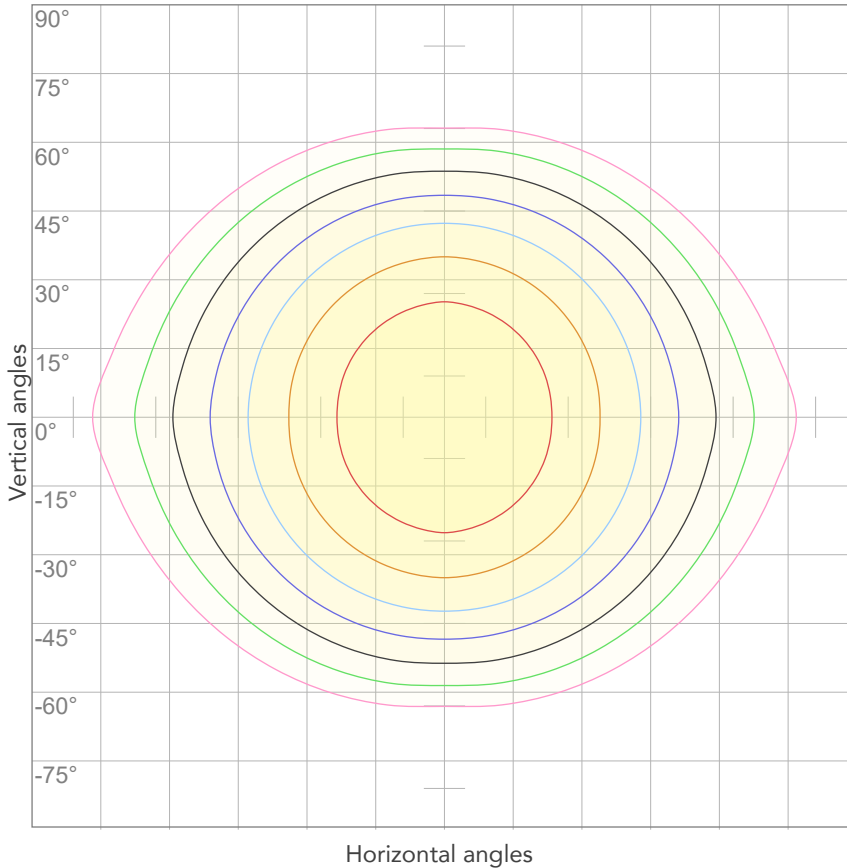

10%	4 cd
20%	9 cd
30%	13 cd
40%	17 cd
50%	22 cd
60%	26 cd
70%	30 cd
80%	35 cd

Conditions:

Number of c-planes: 4

Candela at center: 43 cd

ISO LUX DIAGRAM

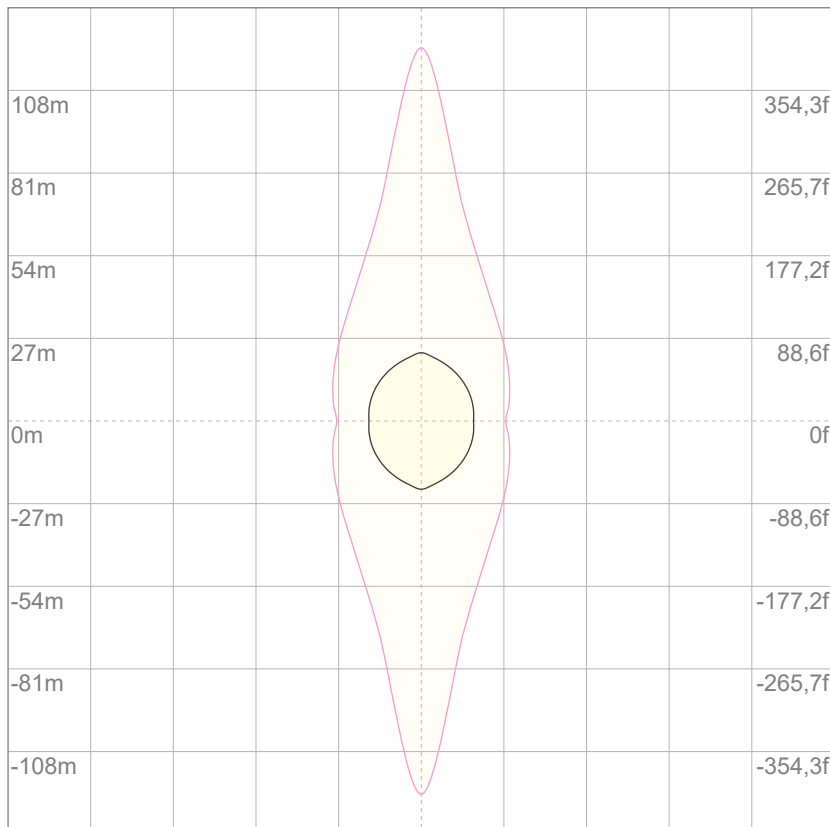

Mounting height: 10 meters (33 feet)

3%	13,0m lx
5%	21,7m lx
10%	43,4m lx
30%	0,130 lx
50%	0,217 lx

Conditions:

Number of c-planes: 4

Lux at center: 0,434 lx

Lux distribution on a surface when lamp is mounted at 10 meters from the surface.

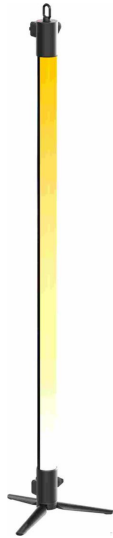

Total lumen output:

1990 lm

Peak candela output:

535 cd

PRODUCT NAME:

ECLSOFTTUBE100

MEASUREMENT CONDITIONS:

Beam angle:

Native

Target:

White

Operator:

Paolo Carvone

Date and time:

24/10/2022 18:19:57

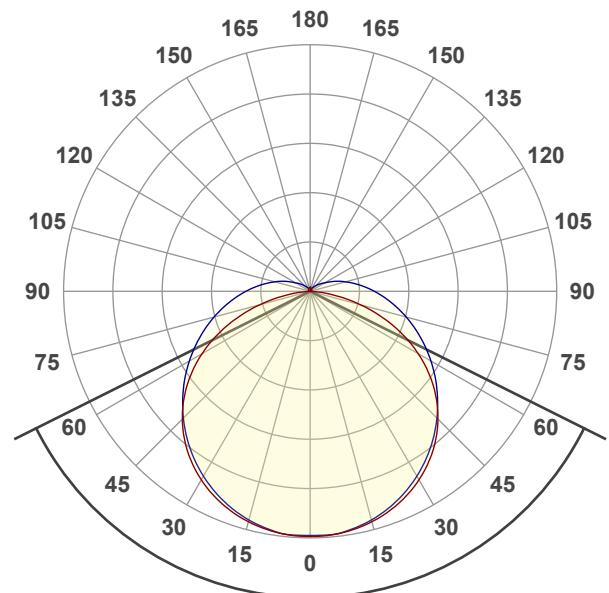

Beam angle 50%: 126,9°

Field angle 10%: 194,6°

Cut off angle 2.5%: 225,7°

Spectra

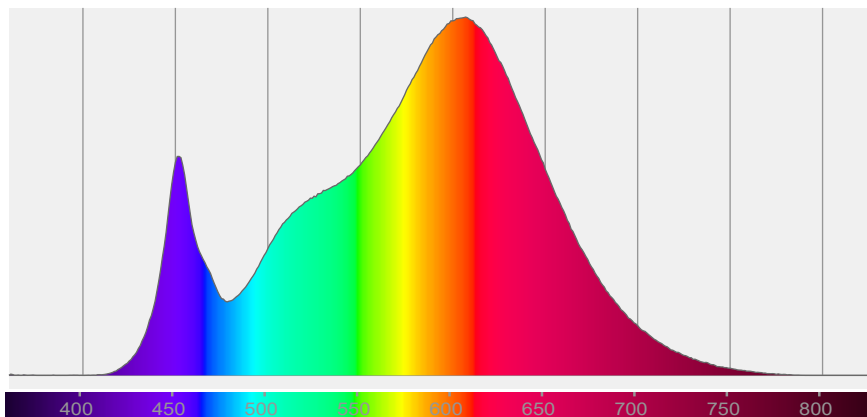

BEAM DETAILS



Beam angle 50%	Field angle 10%	Cut off angle 2,5%	Intensity ratio in 120° cone	Intensity ratio in 90° cone
126,9°	194,6°	225,7°	65,2%	42,9%

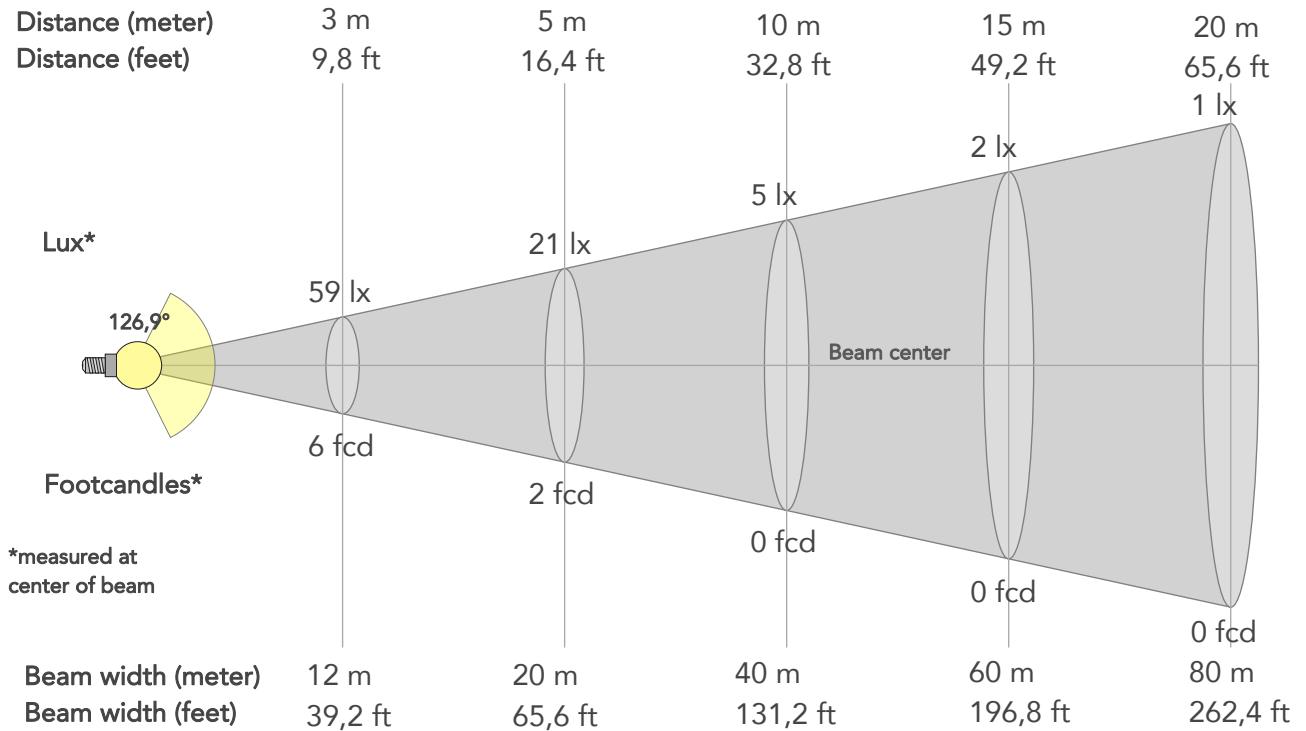

BEAM INTENSITIES AND WIDTHS

Distance	1m	2m	3m	4m	5m	7,5m	10m	15m	20m	25m	30m	40m	50m
Distance	3,3ft	6,6ft	9,8ft	13,1ft	16,4ft	24,6ft	32,8ft	49,2ft	65,6ft	82ft	98,4ft	131,2ft	164ft
Lux	534lx	133lx	59lx	33lx	21lx	9lx	5lx	2lx	1lx	1lx	1lx	0lx	0lx
Footcand.	50fcd	12fcd	6fcd	3fcd	2fcd	1fcd	0fcd	0fcd	0fcd	0fcd	0fcd	0fcd	0fcd
Beam wid.	4m	8m	12m	16m	20m	30m	40m	60m	80m	100m	120m	160m	200m
Beam wid.	13,2ft	26,4ft	39,2ft	52,4ft	65,6ft	98,4ft	131,2ft	196,8ft	262,4ft	328ft	393,6ft	524,8ft	656,1ft

LINEAR DISTRIBUTION DIAGRAM

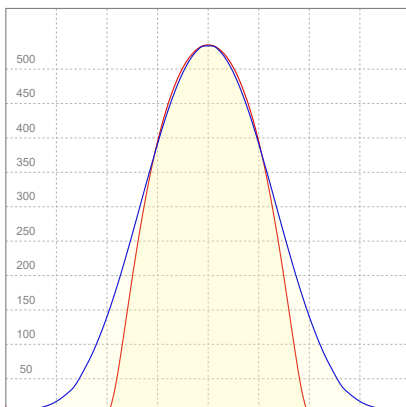

ELECTRICAL SPECIFICATIONS

Input voltage	Input current	Input power	Effeciency
224V	0,163A	33,8W	59lm/W

Power FC
0,92

ISO CANDELA DIAGRAM

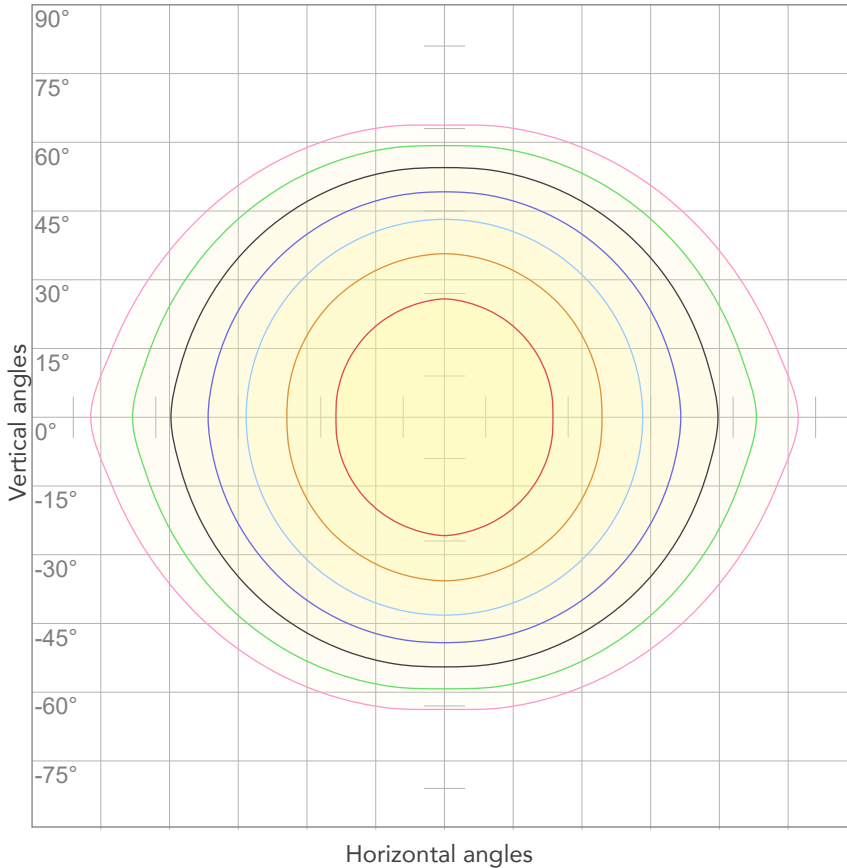

10%	53 cd
20%	107 cd
30%	160 cd
40%	214 cd
50%	267 cd
60%	320 cd
70%	374 cd
80%	427 cd

Conditions:

Number of c-planes: 4
Candela at center: 534 cd

ISO LUX DIAGRAM

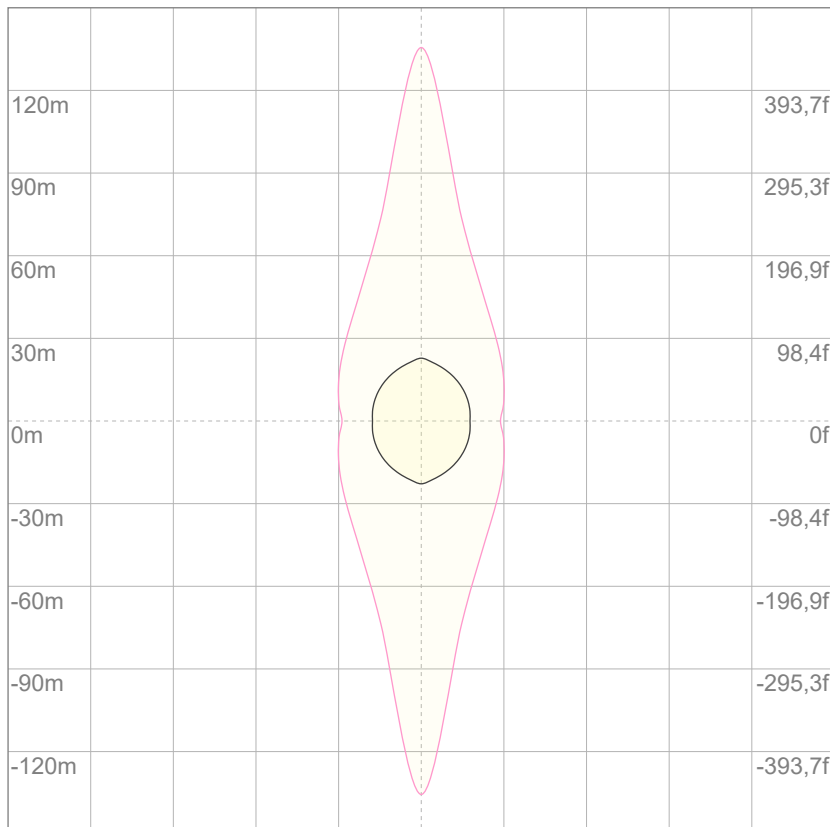

3%	0,160 lx
5%	0,267 lx
10%	0,534 lx
30%	1,60 lx
50%	2,67 lx

Conditions:

Number of c-planes: 4
Lux at center: 5,34 lx

Lux distribution on a surface when lamp is mounted at 10 meters from the surface.

Mounting height: 10 meters (33 feet)

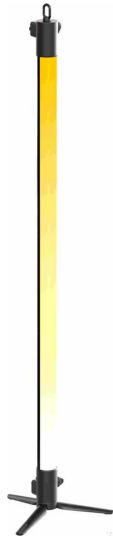

Total lumen output:

2831 lm

Peak candela output:

734 cd

Light quality:

CRI: 90,3

Color temperature:

2819 K

PRODUCT NAME:

ECLSOFTTUBE100

MEASURAMENT CONDITIONS:

Beam angle:

Native

Target:

2800K

Operator:

Paolo Carvone

Date and time:

12/01/2021 11:24:37

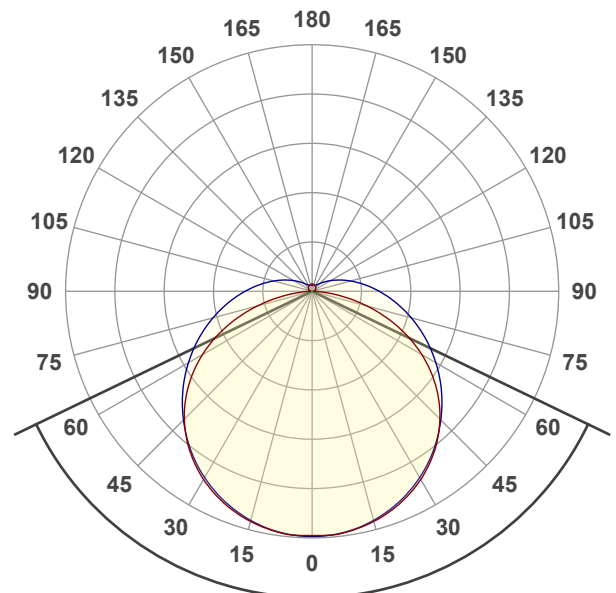

Beam angle 50%: 128,5°

Field angle 10%: 198,9°

Cut off angle 2.5%: 360°

Spectra

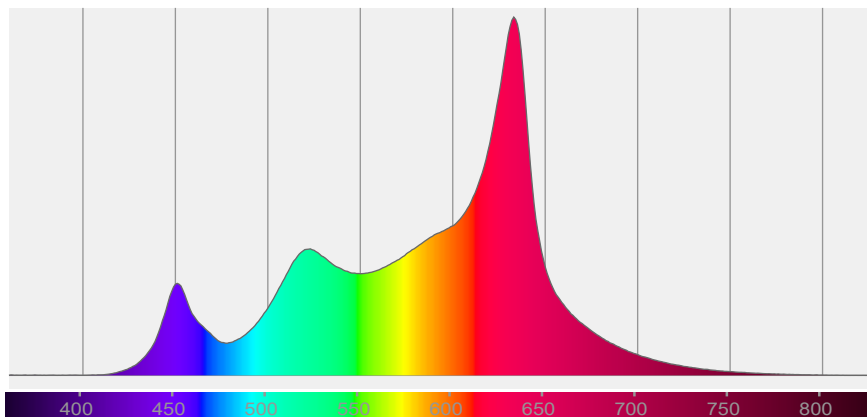

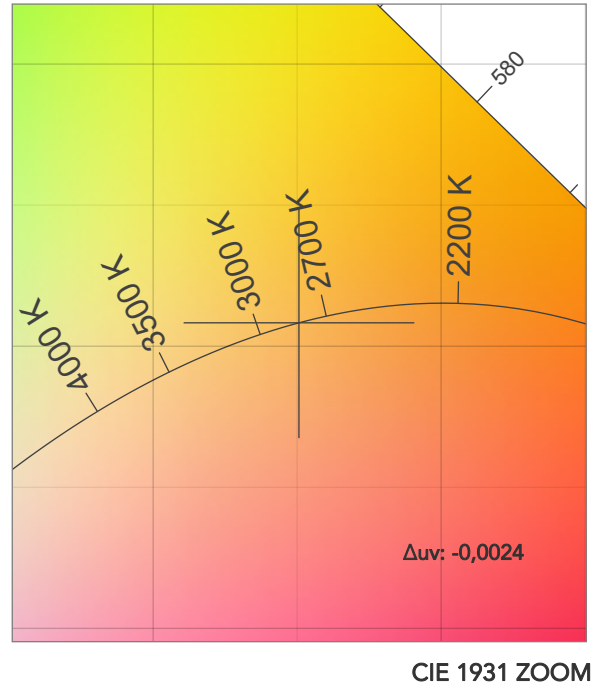
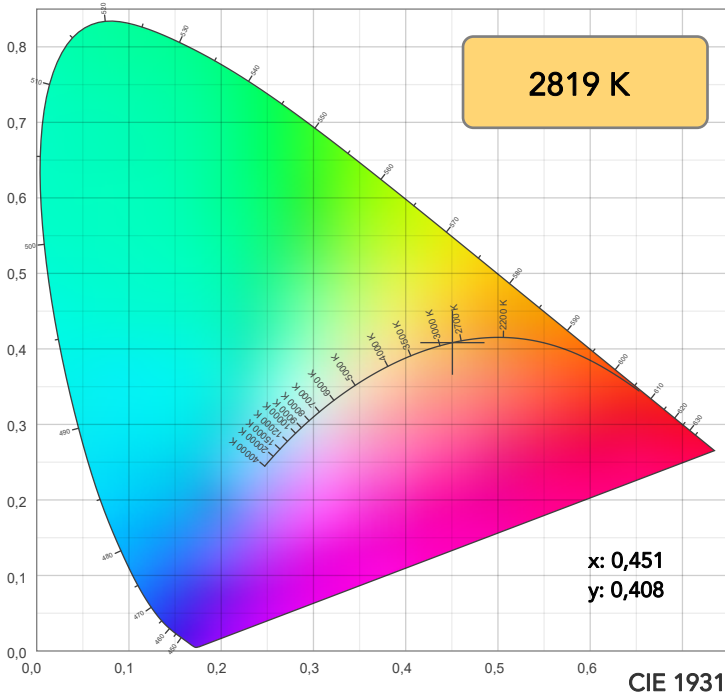

TM30: 91,4

CRI: 90,3 (R1-R8)

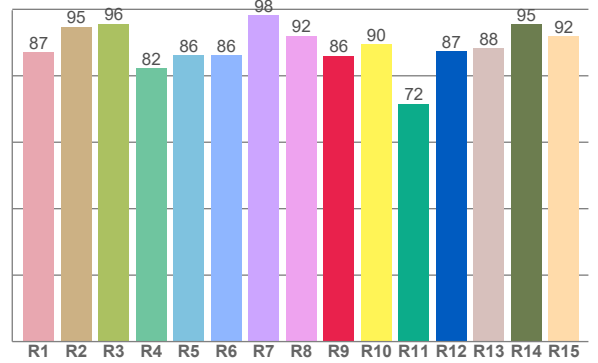
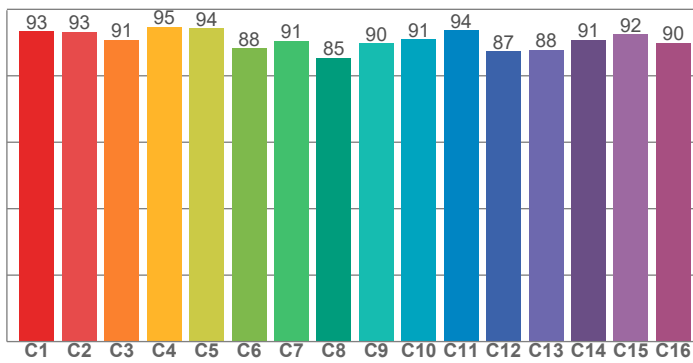

CRI R values, only R1-R8 are used to calculate final CRI value

R1	R2	R3	R4	R5	R6	R7	R8	R9	R10	R11	R12	R13	R14	R15
87,1	94,8	95,7	82,3	86,2	86,2	98,2	92,1	86,1	89,5	71,6	87,3	88,3	95,5	91,9

TM30 C values, 16 binned values out of total of 99 C values

C1	C2	C3	C4	C5	C6	C7	C8	C9	C10	C11	C12	C13	C14	C15	C16
93,4	93,1	90,8	94,7	94,3	88,3	90,5	85,3	89,8	90,9	93,7	87,4	87,9	90,8	92,5	89,9

CQS Q values

Q1	Q2	Q3	Q4	Q5	Q6	Q7	Q8	Q9	Q10	Q11	Q12	Q13	Q14	Q15
96,0	93,8	96,7	89,4	85,9	84,6	92,8	95,7	96,4	96,3	90,9	90,6	92,3	92,9	95,0

CQS: 91,5

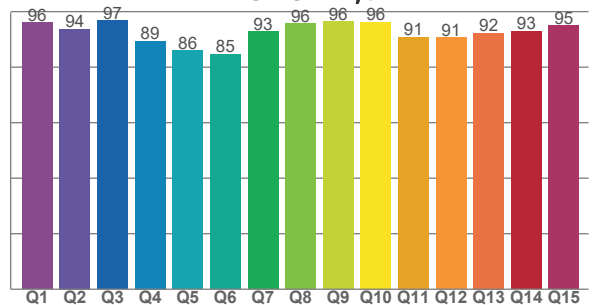

COLOR PARAMETERS

Color temperature	Color rendering index	Red component	Color fidelity	Color gamut	Color quality scale	Television lighting index	Color coordinate cie 1931	Color coordinate cie 1931	Color deviation from black body
CCT	CRI	CRI R9	TM30 Rf	TM30 Rg	CQS	TLCI	x	y	Δuv
2819 K	90,3	86,1	91,4	106,2	91,5	82	0,451	0,408	-0,0024

TM30 DETAILS

Rf 91,4
Fidelity index Rf

Rg 106,2
Gammut index

Hue Bin	R _f	Graphic shifts (%)	
		Chroma	Hue
1	93	2%	-1%
2	93	3%	-2%
3	91	2%	-2%
4	95	0%	-2%
5	94	2%	3%
6	88	7%	5%
7	91	6%	1%
8	85	9%	-2%
9	90	5%	-3%
10	91	3%	-5%
11	94	3%	-3%
12	87	4%	-6%
13	88	3%	-9%
14	91	2%	-6%
15	92	1%	0%
16	90	2%	-7%

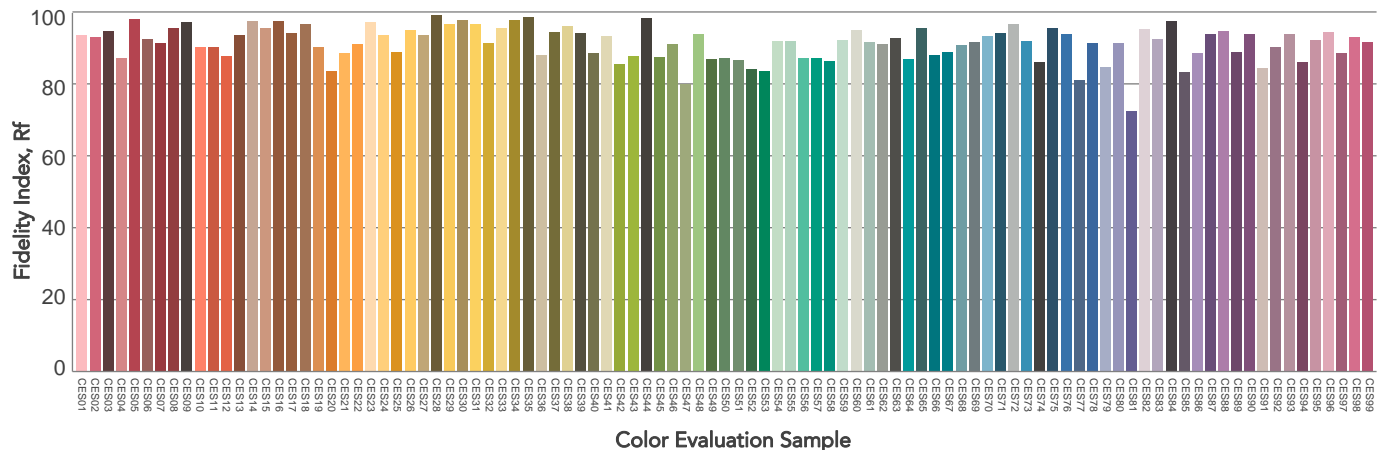
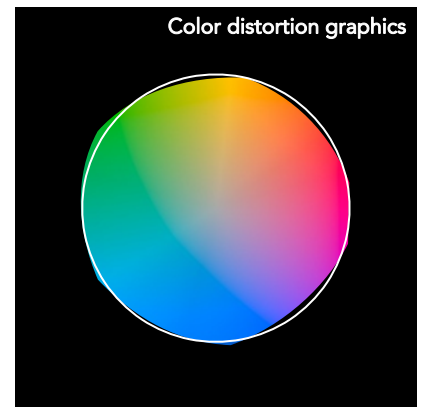
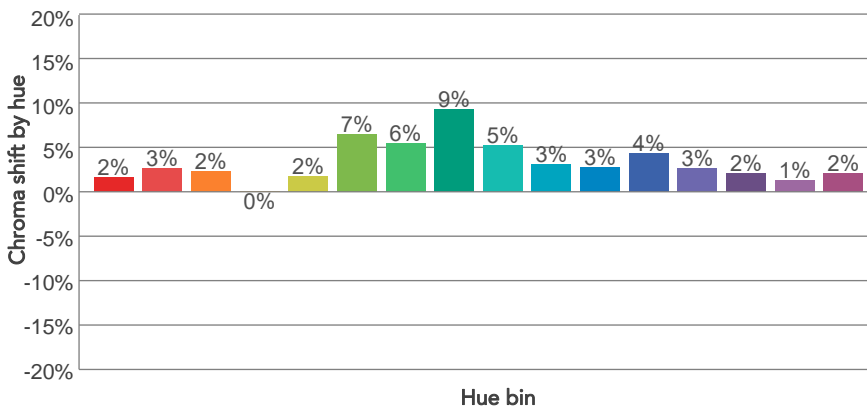
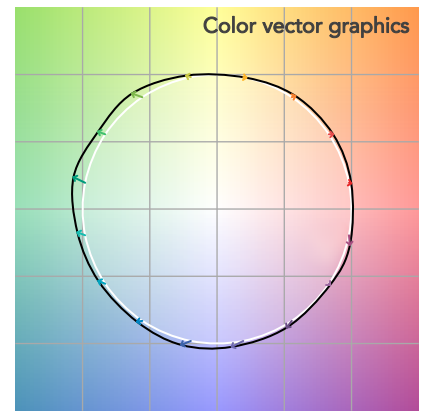
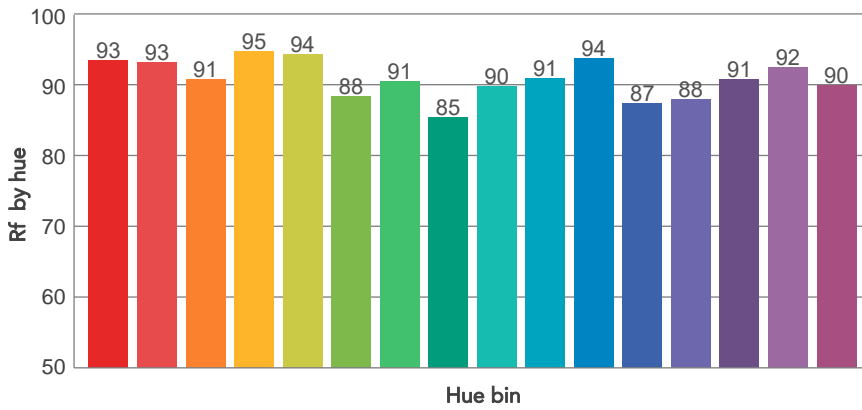
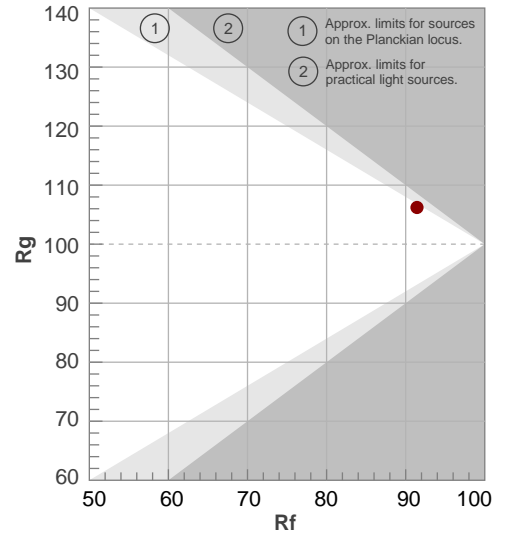

BEAM DETAILS



Beam angle 50%	Field angle 10%	Cut off angle 2,5%	Intensity ratio in 120° cone	Intensity ratio in 90° cone
128,5°	198,9°	360°	63,3%	41,5%

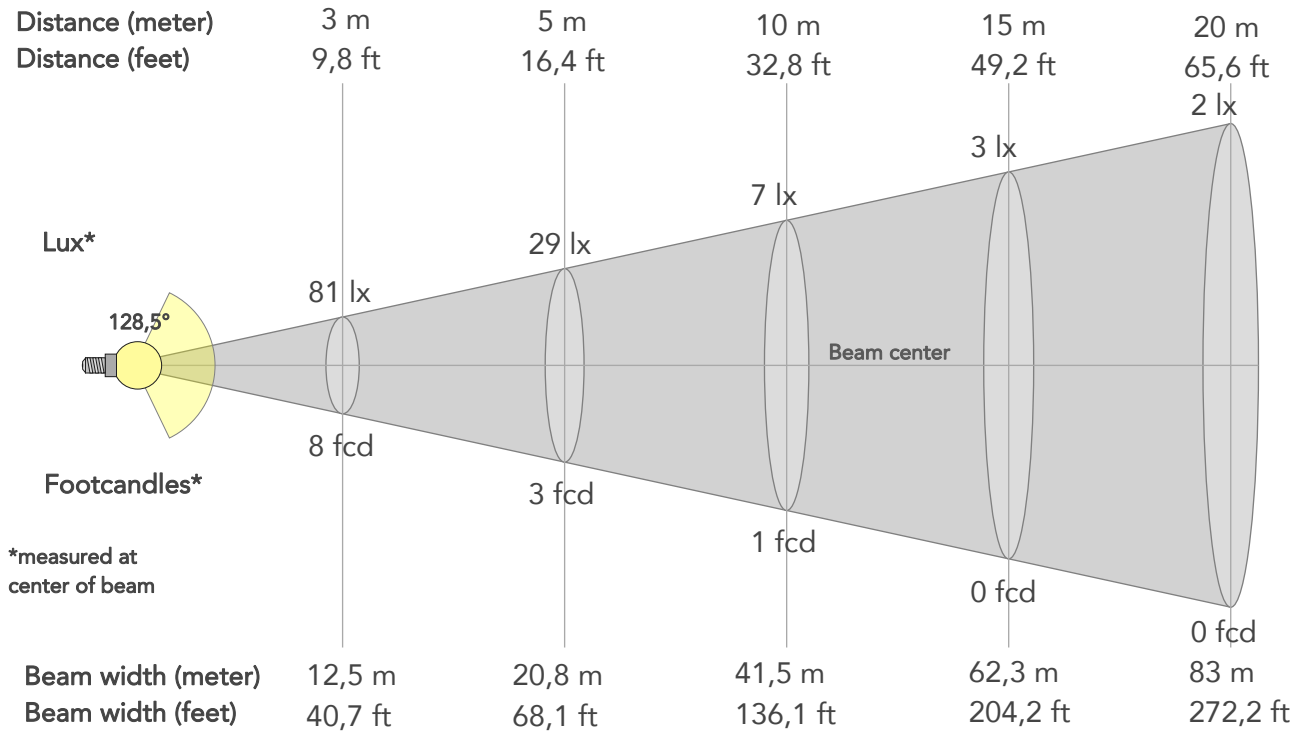

BEAM INTENSITIES AND WIDTHS

Distance	1m	2m	3m	4m	5m	7,5m	10m	15m	20m	25m	30m	40m	50m
Distance	3,3ft	6,6ft	9,8ft	13,1ft	16,4ft	24,6ft	32,8ft	49,2ft	65,6ft	82ft	98,4ft	131,2ft	164ft
Lux	733lx	183lx	81lx	46lx	29lx	13lx	7lx	3lx	2lx	1lx	1lx	0lx	0lx
Footcand.	68fcd	17fcd	8fcd	4fcd	3fcd	1fcd	1fcd	0fcd	0fcd	0fcd	0fcd	0fcd	0fcd
Beam wid.	4,2m	8,3m	12,5m	16,6m	20,8m	31,1m	41,5m	62,3m	83m	103,8m	124,5m	166m	207,5m
Beam wid.	13,7ft	27,4ft	40,7ft	54,4ft	68,1ft	102,1ft	136,1ft	204,2ft	272,2ft	340,3ft	408,4ft	544,5ft	680,6ft

LINEAR DISTRIBUTION DIAGRAM

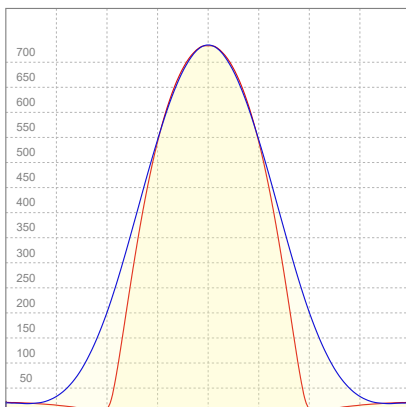

ELECTRICAL SPECIFICATIONS

Input voltage	Input current	Input power	Effeciency
225V	0,257A	55,3W	51lm/W

ISO CANDELA DIAGRAM

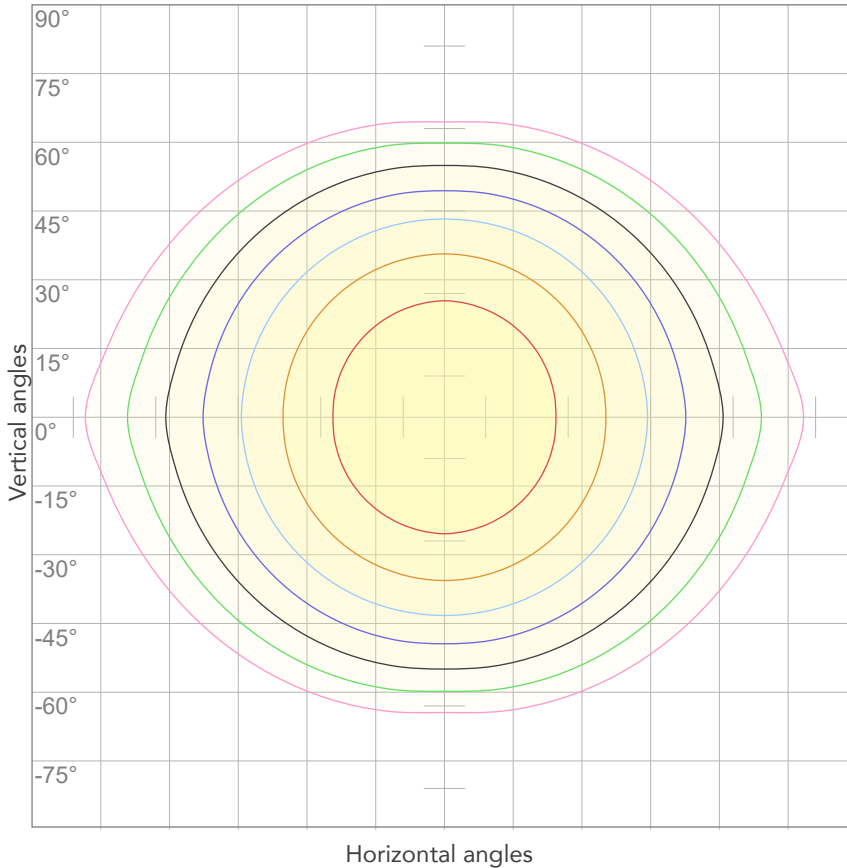

10%	73 cd
20%	147 cd
30%	220 cd
40%	293 cd
50%	367 cd
60%	440 cd
70%	513 cd
80%	587 cd

Conditions:

Number of c-planes: 4

Candela at center: 733 cd

ISO LUX DIAGRAM

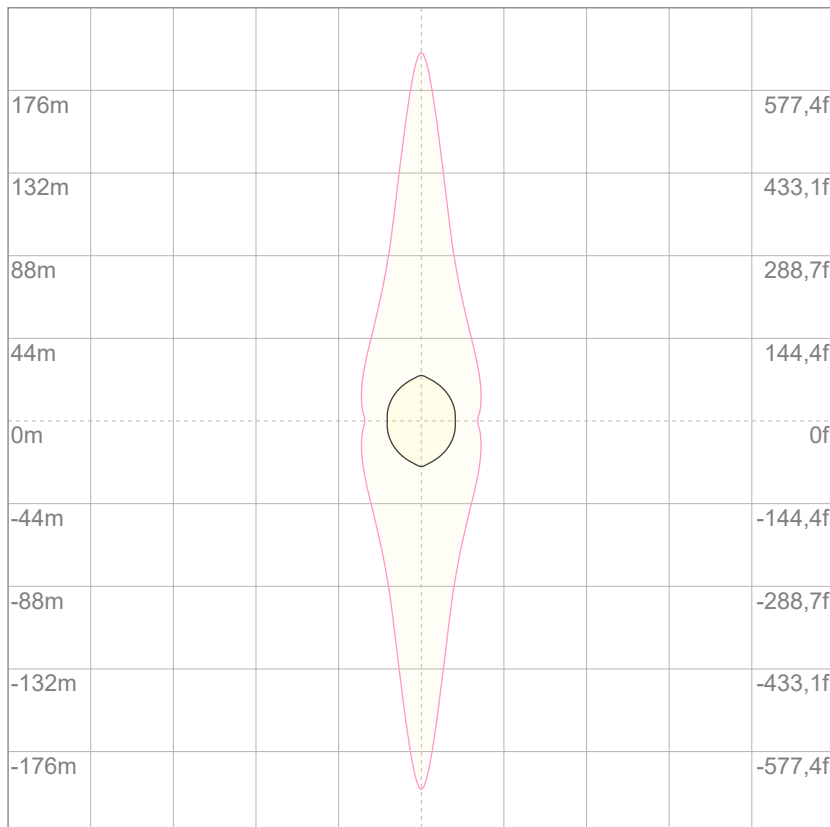

Mounting height: 10 meters (33 feet)

3%	0,220 lx
5%	0,367 lx
10%	0,733 lx
30%	2,20 lx
50%	3,67 lx

Conditions:

Number of c-planes: 4

Lux at center: 7,33 lx

Lux distribution on a surface when lamp is mounted at 10 meters from the surface.

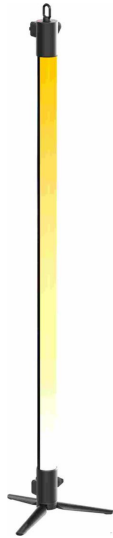

Total lumen output:

2908 lm

Peak candela output:

753 cd

Light quality:

CRI: 90,7

Color temperature:

3201 K

PRODUCT NAME:

ECLSOFTTUBE100

MEASURAMENT CONDITIONS:

Beam angle:

Native

Target:

3200K

Operator:

Paolo Carvone

Date and time:

12/01/2021 11:29:18

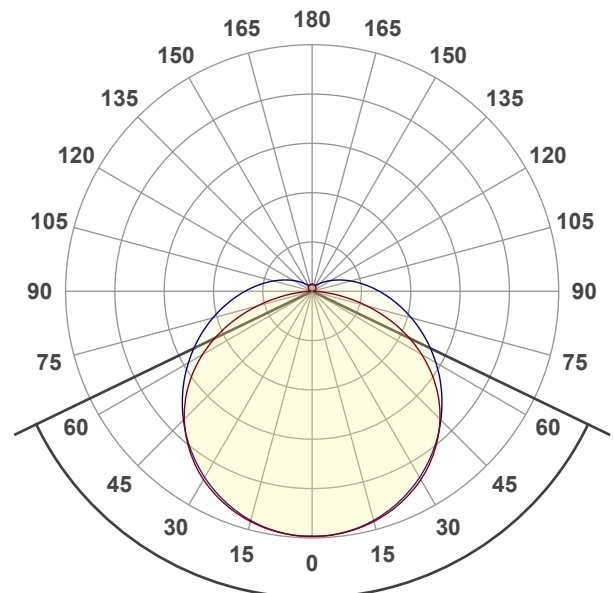

Beam angle 50%: 128,5°

Field angle 10%: 199°

Cut off angle 2.5%: 360°

Spectra

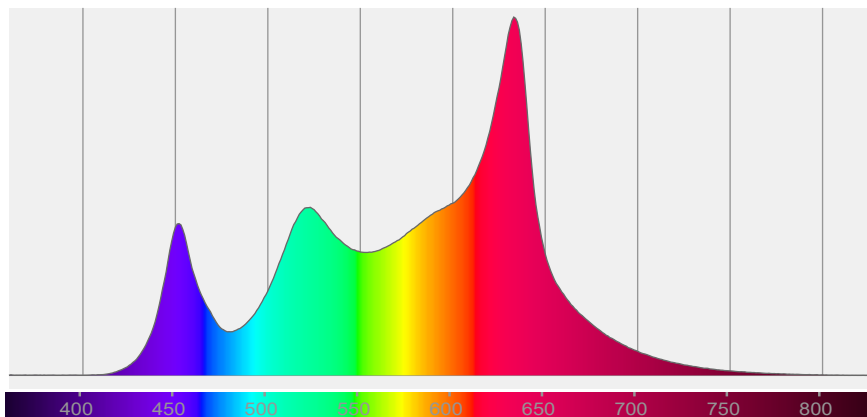

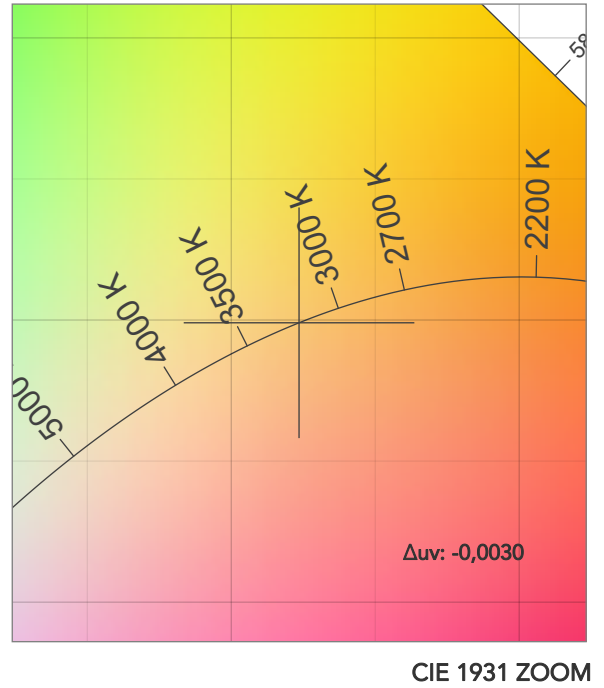
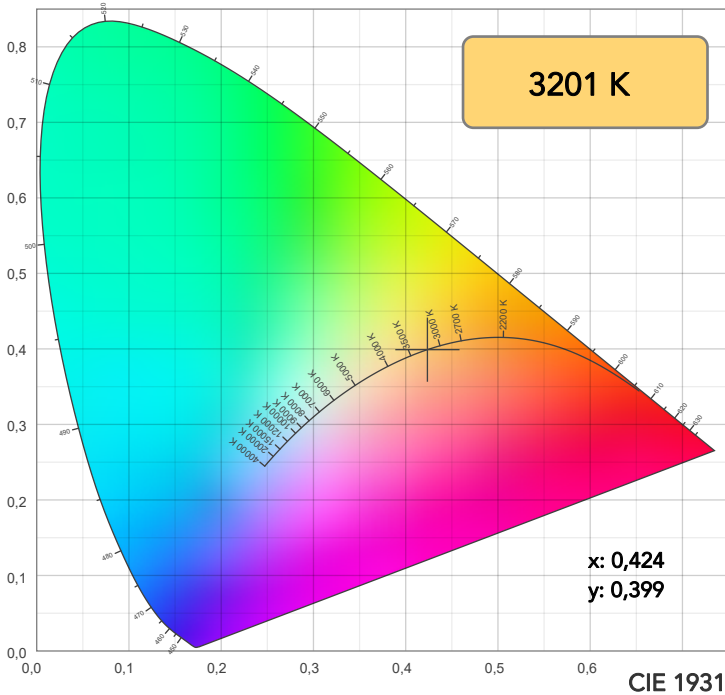

TM30: 92,0

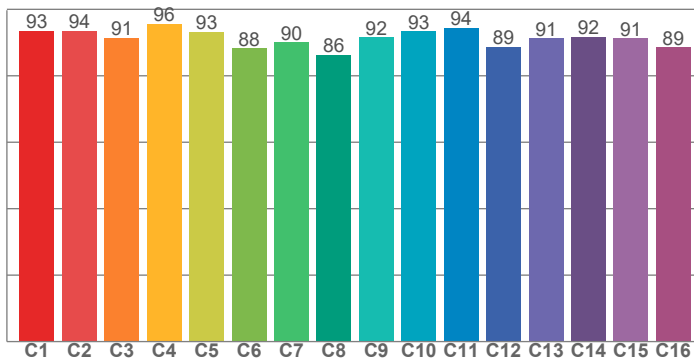

CRI: 90,7 (R1-R8)

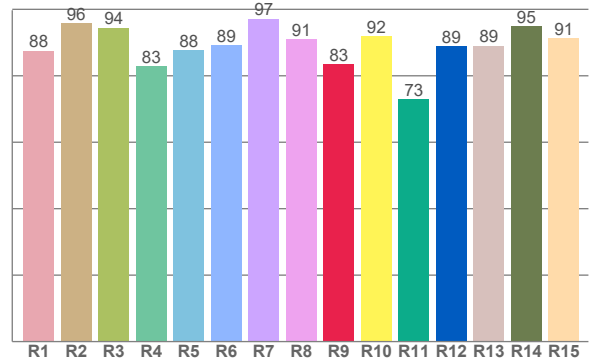

CRI R values, only R1-R8 are used to calculate final CRI value

R1	R2	R3	R4	R5	R6	R7	R8	R9	R10	R11	R12	R13	R14	R15
87,5	95,8	94,4	82,8	87,7	89,1	97,2	91,0	83,4	92,0	72,8	89,0	89,0	94,9	91,4

TM30 C values, 16 binned values out of total of 99 C values

C1	C2	C3	C4	C5	C6	C7	C8	C9	C10	C11	C12	C13	C14	C15	C16
93,5	93,5	91,4	95,7	93,1	88,2	90,0	86,3	91,6	93,4	94,4	88,6	91,2	91,7	91,3	88,6

CQS Q values

Q1	Q2	Q3	Q4	Q5	Q6	Q7	Q8	Q9	Q10	Q11	Q12	Q13	Q14	Q15
97,7	96,3	94,9	93,3	88,5	86,4	93,5	96,2	96,1	98,2	92,3	91,6	93,1	94,1	95,6

CQS: 92,9

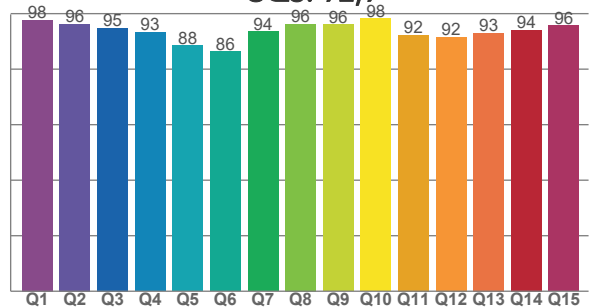

COLOR PARAMETERS

Color temperature	Color rendering index	Red component	Color fidelity	Color gamut	Color quality scale	Television lighting index	Color coordinate cie 1931	Color coordinate cie 1931	Color deviation from black body
CCT	CRI	CRI R9	TM30 Rf	TM30 Rg	CQS	TLCI	x	y	Δuv
3201 K	90,7	83,4	92,0	106,6	92,9	84	0,424	0,399	-0,0030

TM30 DETAILS

Rf 92,0
Fidelity index Rf

Rg 106,6
Gammut index

Hue Bin	R _f	Graphic shifts (%)	
		Chroma	Hue
1	93	2%	-1%
2	94	3%	-2%
3	91	2%	-1%
4	96	0%	-2%
5	93	0%	2%
6	88	6%	5%
7	90	5%	2%
8	86	9%	-2%
9	92	5%	-2%
10	93	2%	-2%
11	94	2%	1%
12	89	6%	-4%
13	91	3%	-6%
14	92	4%	-4%
15	91	2%	-1%
16	89	5%	-8%

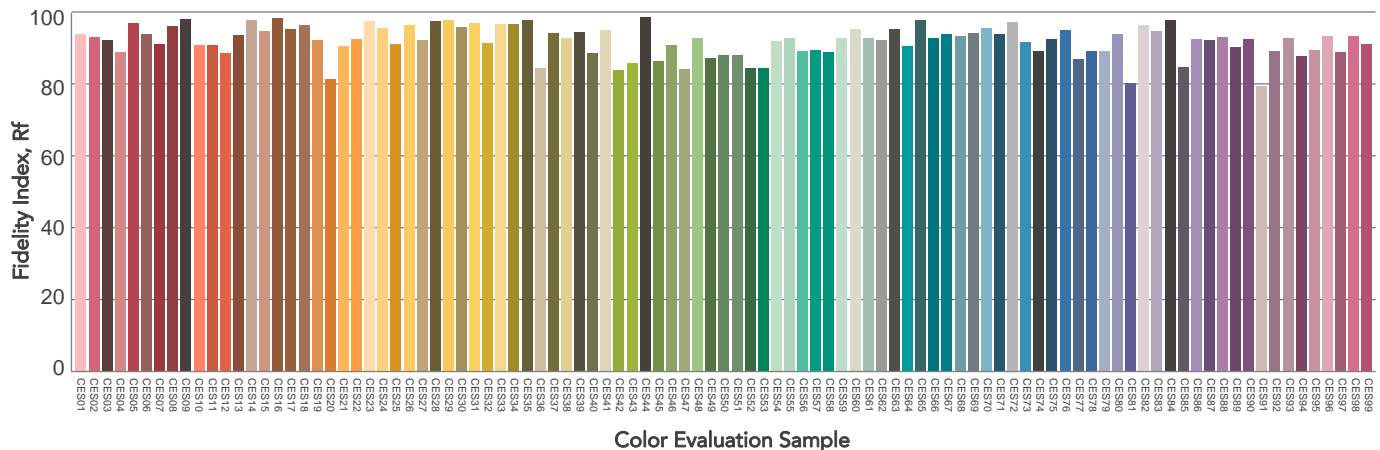
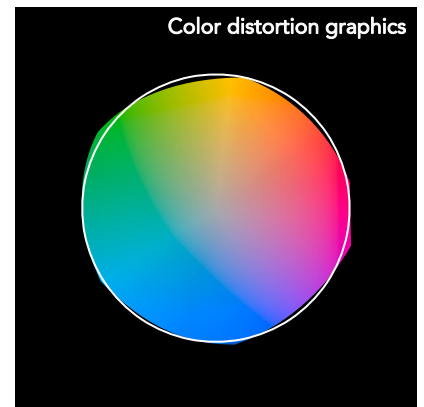
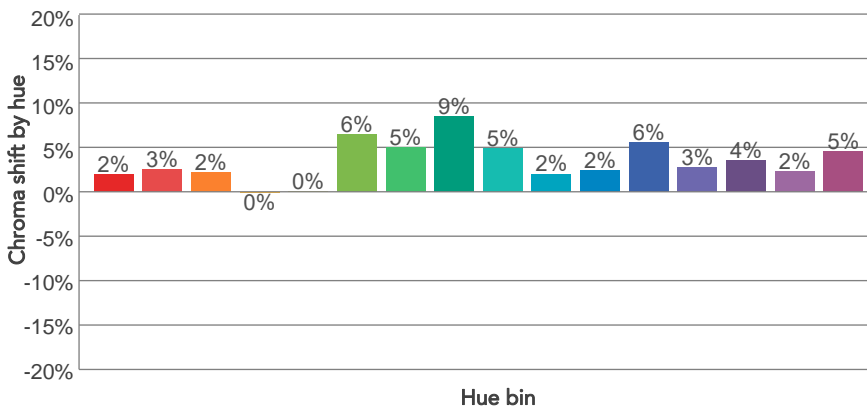
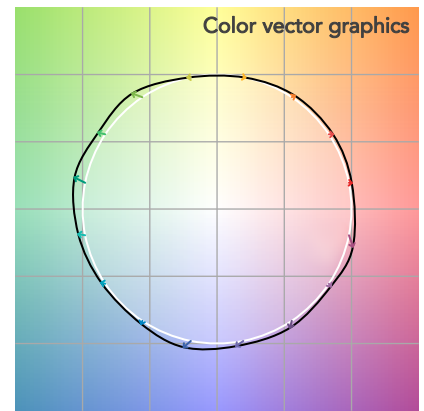
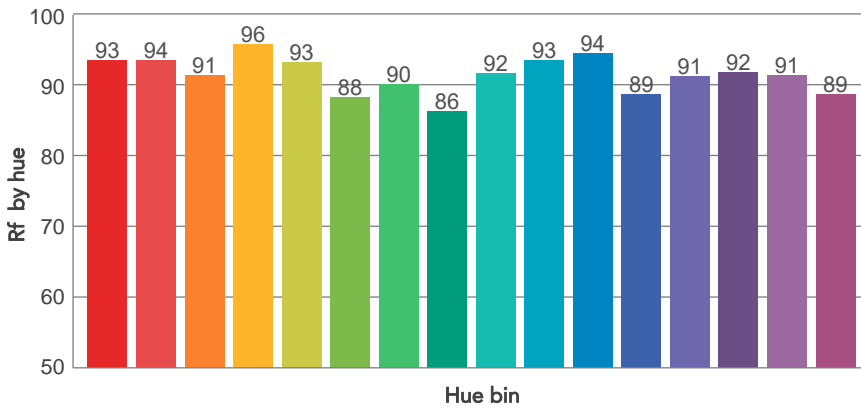
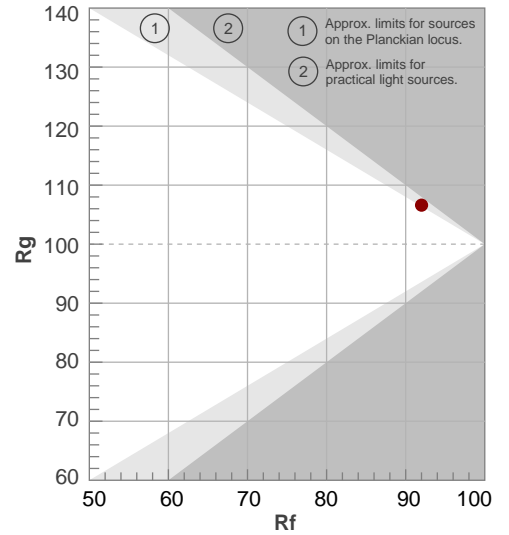

BEAM DETAILS



Beam angle 50%	Field angle 10%	Cut off angle 2,5%	Intensity ratio in 120° cone	Intensity ratio in 90° cone
128,5°	199°	360°	63,2%	41,5%

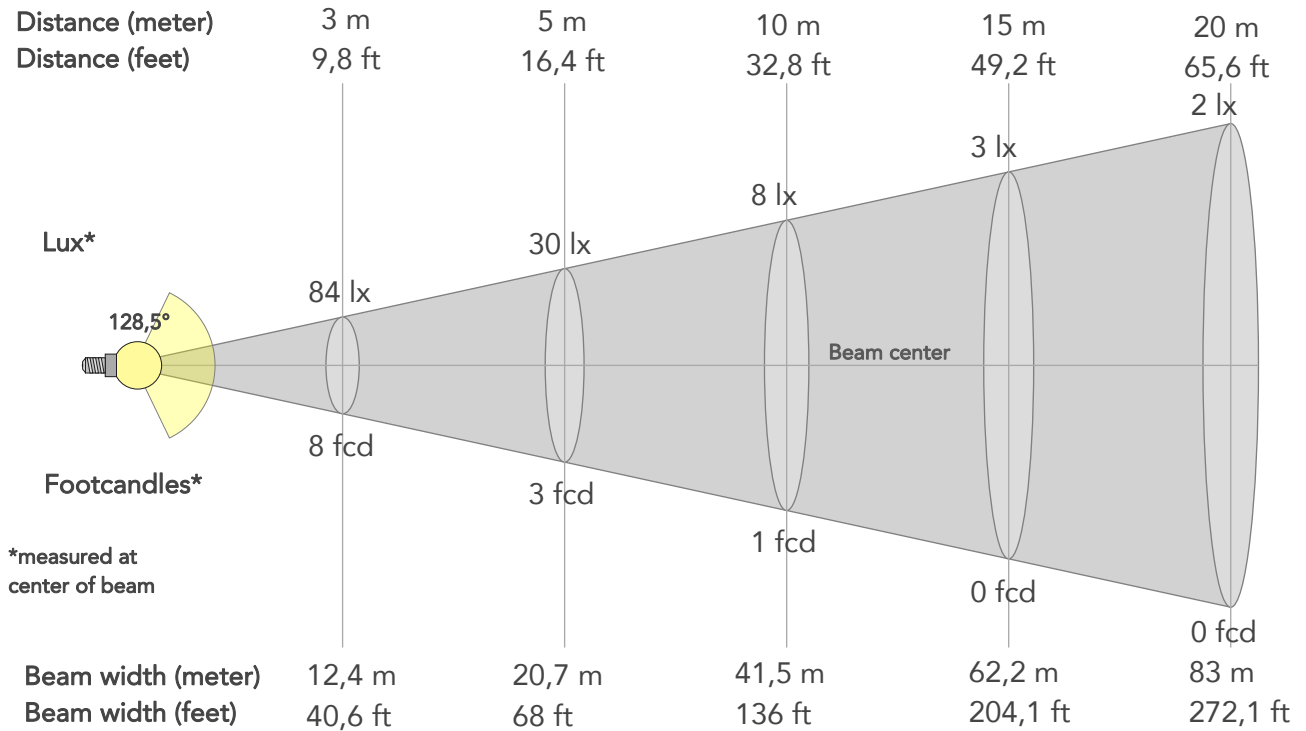

BEAM INTENSITIES AND WIDTHS

Distance	1m	2m	3m	4m	5m	7,5m	10m	15m	20m	25m	30m	40m	50m
Distance	3,3ft	6,6ft	9,8ft	13,1ft	16,4ft	24,6ft	32,8ft	49,2ft	65,6ft	82ft	98,4ft	131,2ft	164ft
Lux	753lx	188lx	84lx	47lx	30lx	13lx	8lx	3lx	2lx	1lx	1lx	0lx	0lx
Footcand.	70fcd	17fcd	8fcd	4fcd	3fcd	1fcd	1fcd	0fcd	0fcd	0fcd	0fcd	0fcd	0fcd
Beam wid.	4,1m	8,3m	12,4m	16,6m	20,7m	31,1m	41,5m	62,2m	83m	103,7m	124,4m	165,9m	207,4m
Beam wid.	13,7ft	27,4ft	40,6ft	54,3ft	68ft	102ft	136ft	204,1ft	272,1ft	340,1ft	408,1ft	544,2ft	680,2ft

LINEAR DISTRIBUTION DIAGRAM

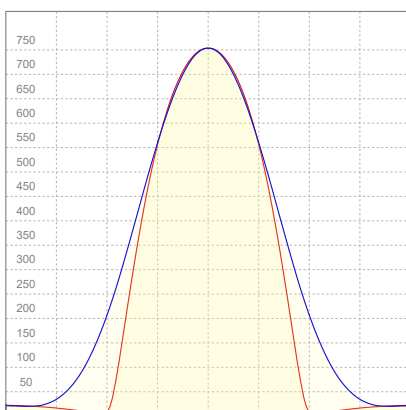

ELECTRICAL SPECIFICATIONS

Input voltage	Input current	Input power	Effeciency
222V	0,266A	56,7W	51lm/W

ISO CANDELA DIAGRAM

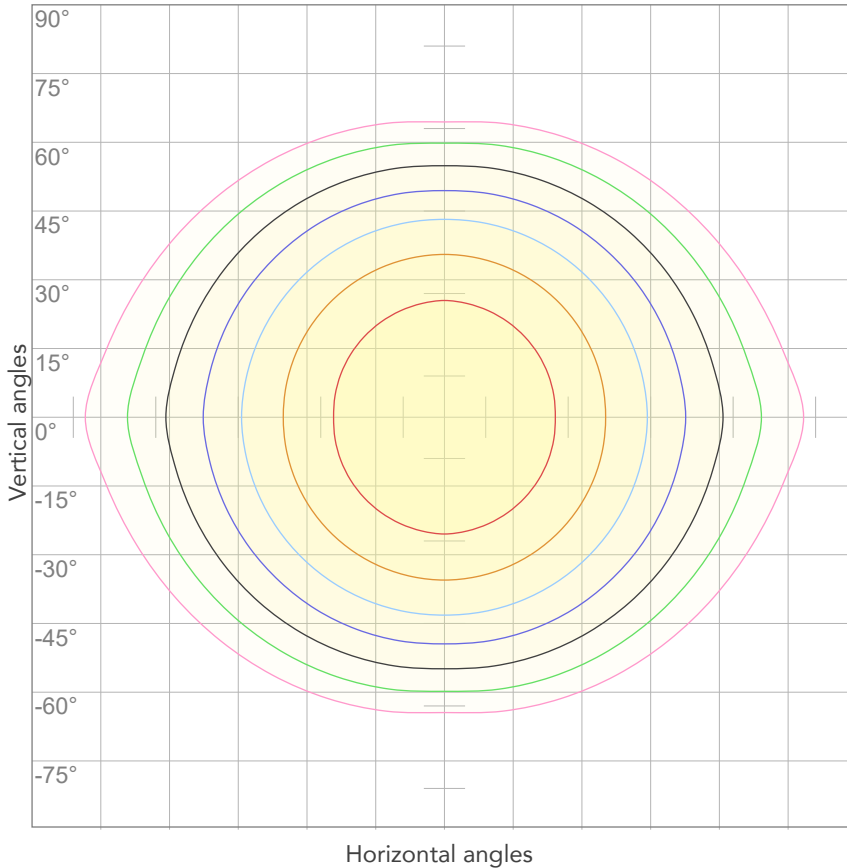

10%	75 cd
20%	151 cd
30%	226 cd
40%	301 cd
50%	376 cd
60%	452 cd
70%	527 cd
80%	602 cd

Conditions:

Number of c-planes: 4
Candela at center: 753 cd

ISO LUX DIAGRAM

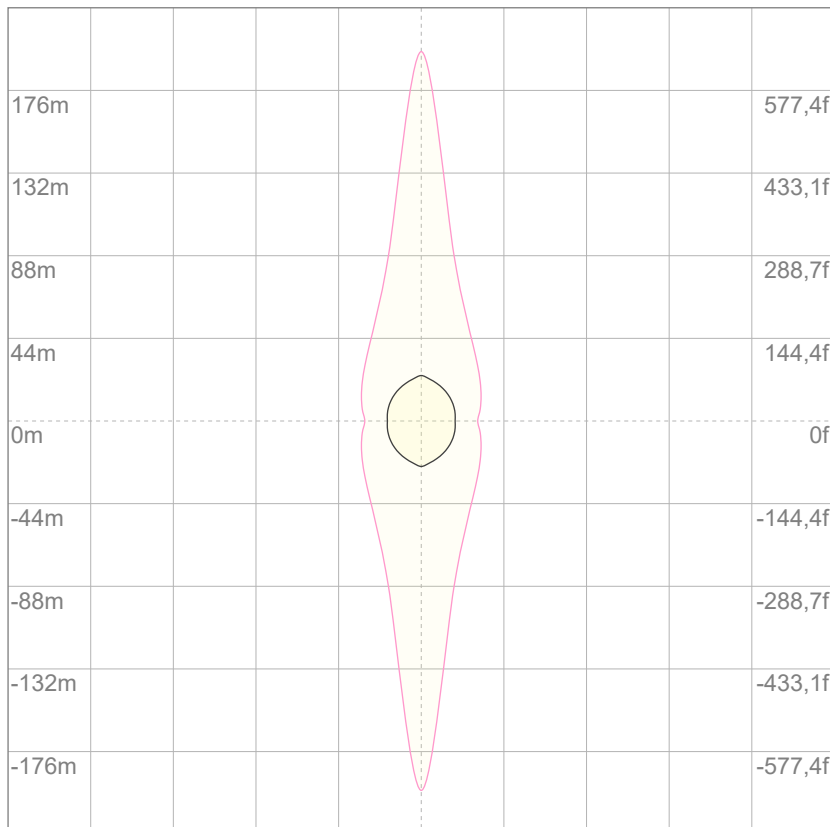

Mounting height: 10 meters (33 feet)

3%	0,226 lx
5%	0,376 lx
10%	0,753 lx
30%	2,26 lx
50%	3,76 lx

Conditions:

Number of c-planes: 4
Lux at center: 7,53 lx

Lux distribution on a surface when lamp is mounted at 10 meters from the surface.

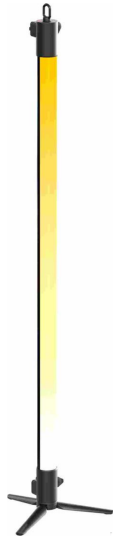

Total lumen output:

3014 lm

Peak candela output:

780 cd

Light quality:

CRI: 92,6

Color temperature:

4019 K

PRODUCT NAME:

ECLSOFTTUBE100

MEASURAMENT CONDITIONS:

Beam angle:

Native

Target:

4000K

Operator:

Paolo Carvone

Date and time:

12/01/2021 11:34:12

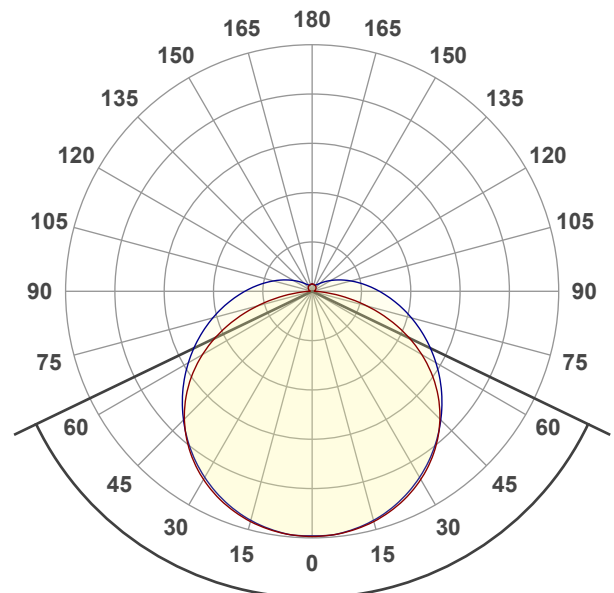

Beam angle 50%: 128,6°

Field angle 10%: 199,2°

Cut off angle 2.5%: 360°

Spectra

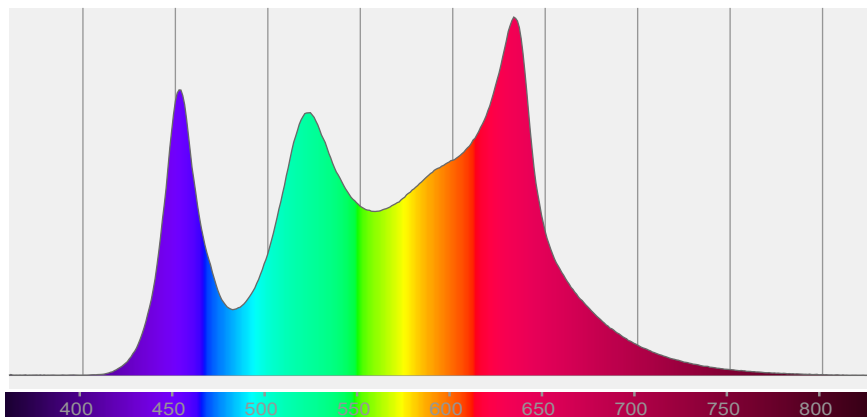

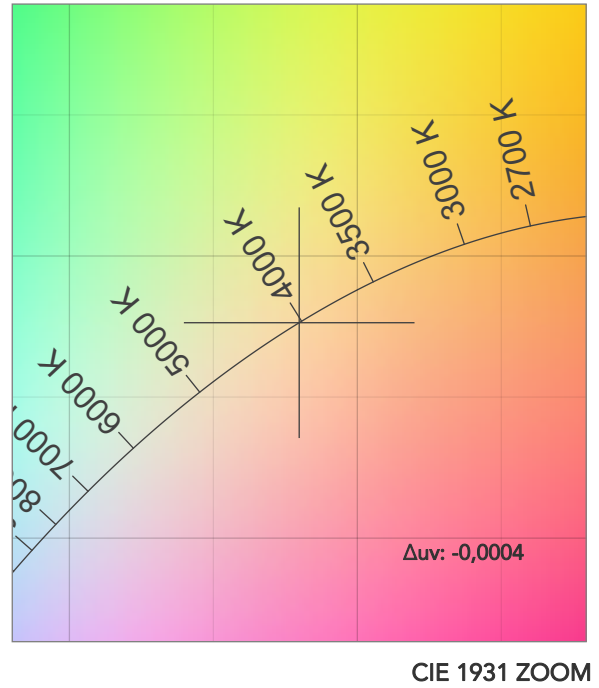
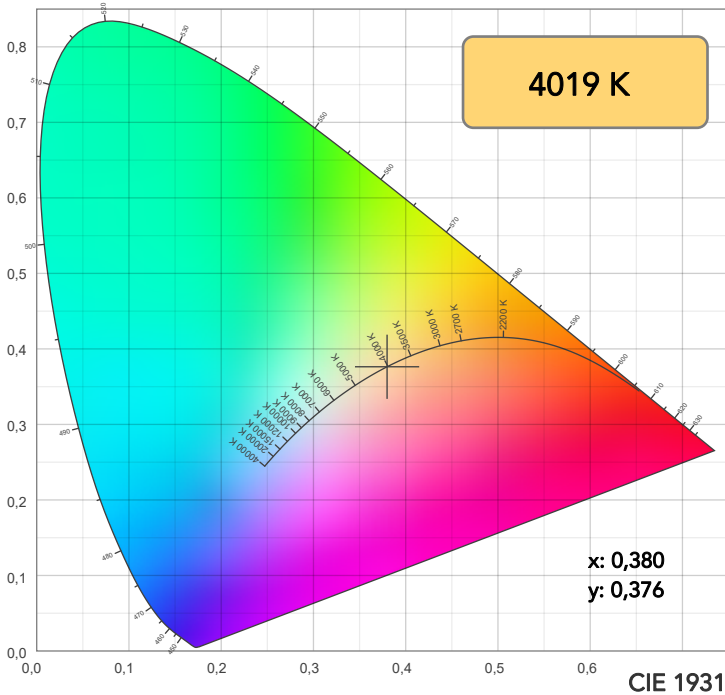

TM30: 92,2

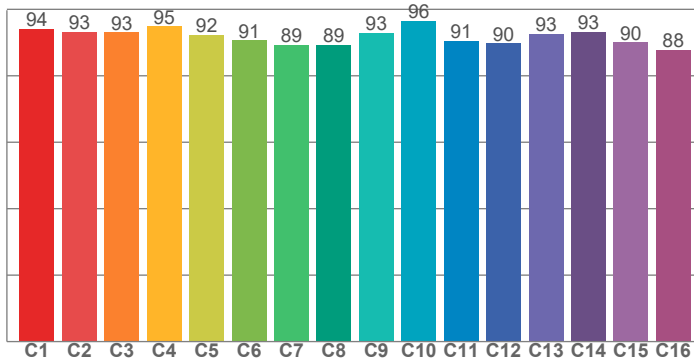

CRI: 92,6 (R1-R8)

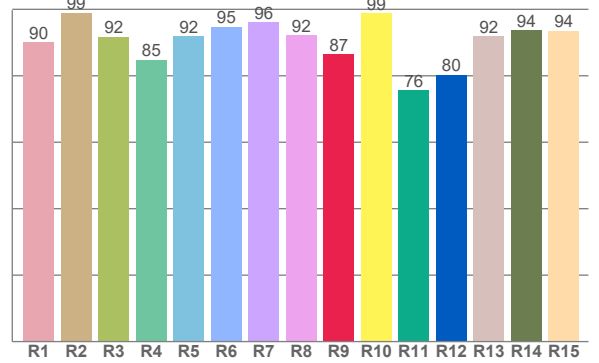

CRI R values, only R1-R8 are used to calculate final CRI value

R1	R2	R3	R4	R5	R6	R7	R8	R9	R10	R11	R12	R13	R14	R15
90,0	98,9	91,7	84,8	91,9	94,8	96,1	92,2	86,5	98,8	75,6	80,3	91,9	93,8	93,6

TM30 C values, 16 binned values out of total of 99 C values

C1	C2	C3	C4	C5	C6	C7	C8	C9	C10	C11	C12	C13	C14	C15	C16
94,1	93,2	93,1	94,9	92,4	90,6	89,3	89,3	93,0	96,5	90,5	89,7	92,6	93,2	90,0	87,8

CQS Q values

Q1	Q2	Q3	Q4	Q5	Q6	Q7	Q8	Q9	Q10	Q11	Q12	Q13	Q14	Q15
97,4	99,0	92,1	98,3	92,9	90,5	96,1	96,2	95,7	99,1	93,0	91,8	93,1	96,6	96,8

CQS: 94,5

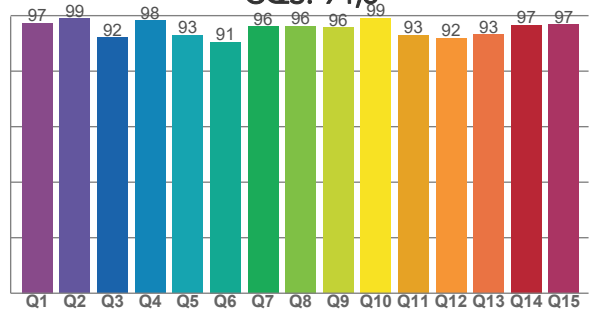

COLOR PARAMETERS

Color temperature	Color rendering index	Red component	Color fidelity	Color gamut	Color quality scale	Television lighting index	Color coordinate cie 1931	Color coordinate cie 1931	Color deviation from black body
CCT	CRI	CRI R9	TM30 Rf	TM30 Rg	CQS	TLCI	x	y	Δuv
4019 K	92,6	86,5	92,2	105,2	94,5	87	0,380	0,376	-0,0004

TM30 DETAILS

Rf 92,2
Fidelity index Rf

Rg 105,2
Gammut index

Hue Bin	R _f	Graphic shifts (%)	
		Chroma	Hue
1	94	2%	-1%
2	93	3%	-2%
3	93	1%	-1%
4	95	-2%	-2%
5	92	-2%	2%
6	91	5%	5%
7	89	6%	2%
8	89	5%	1%
9	93	3%	1%
10	96	0%	1%
11	91	3%	5%
12	90	4%	1%
13	93	4%	-3%
14	93	3%	4%
15	90	4%	-3%
16	88	5%	-5%

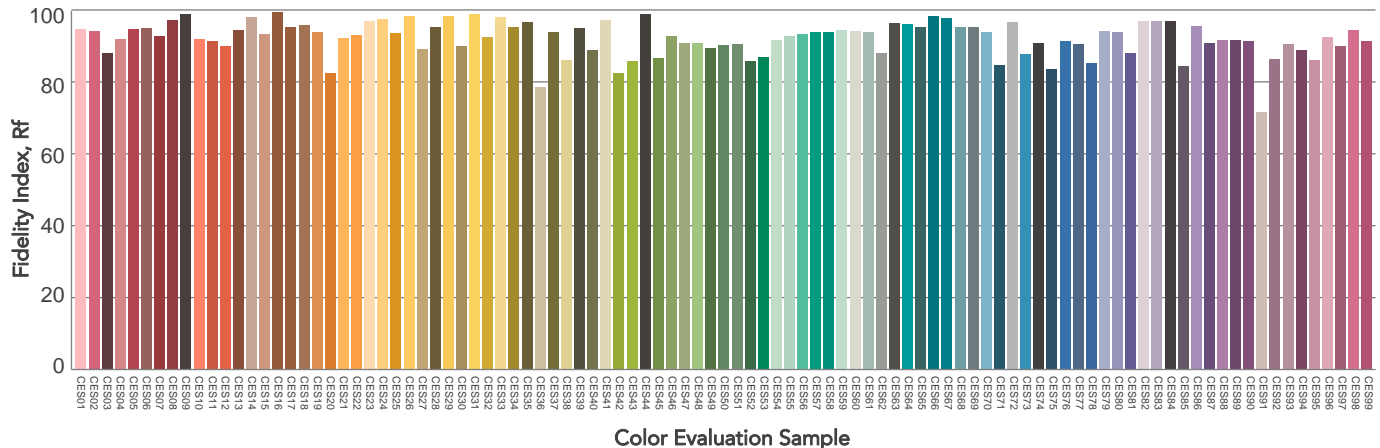
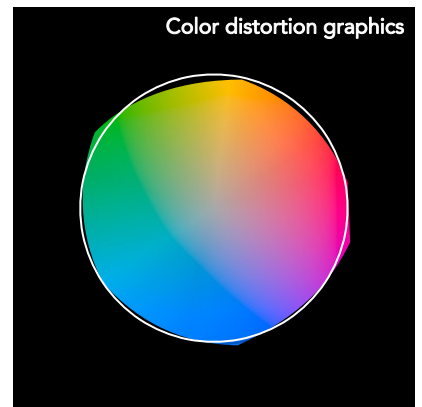
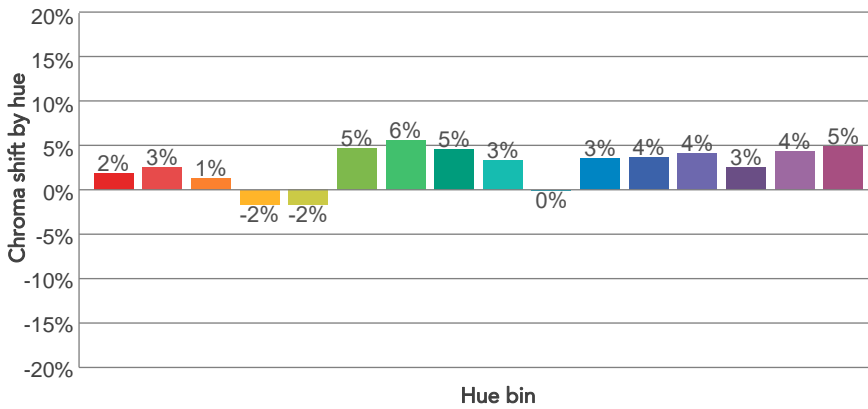
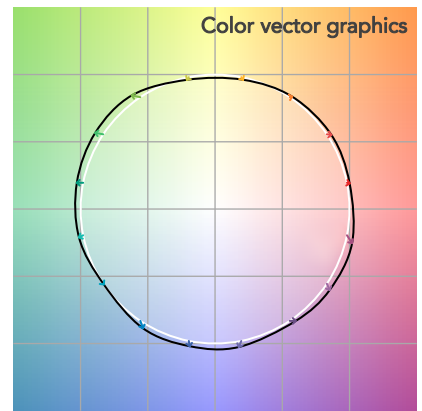
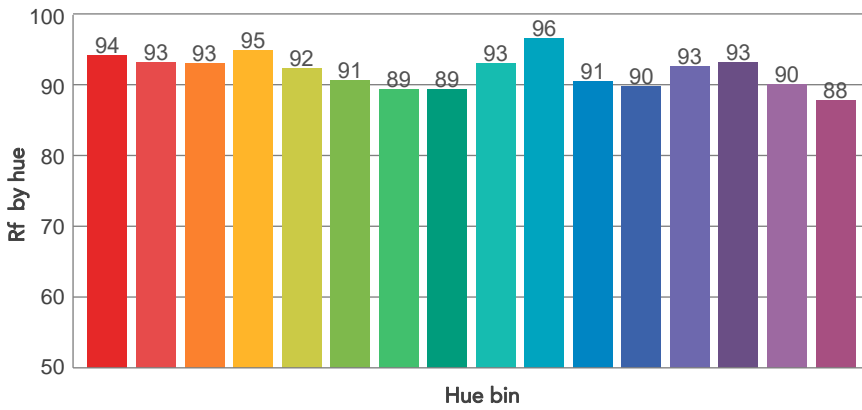
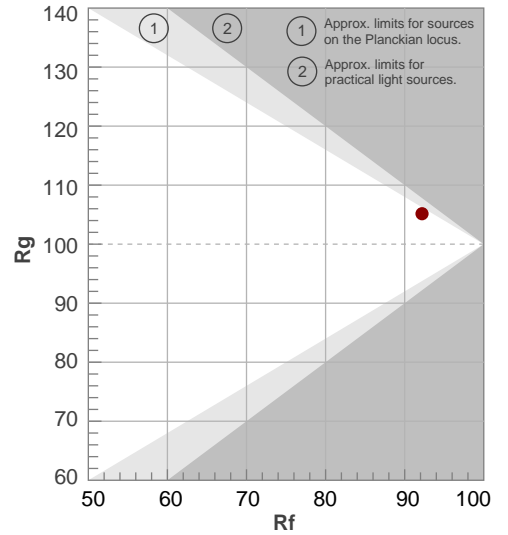

BEAM DETAILS



Beam angle 50%	Field angle 10%	Cut off angle 2,5%	Intensity ratio in 120° cone	Intensity ratio in 90° cone
128,6°	199,2°	360°	63,2%	41,4%

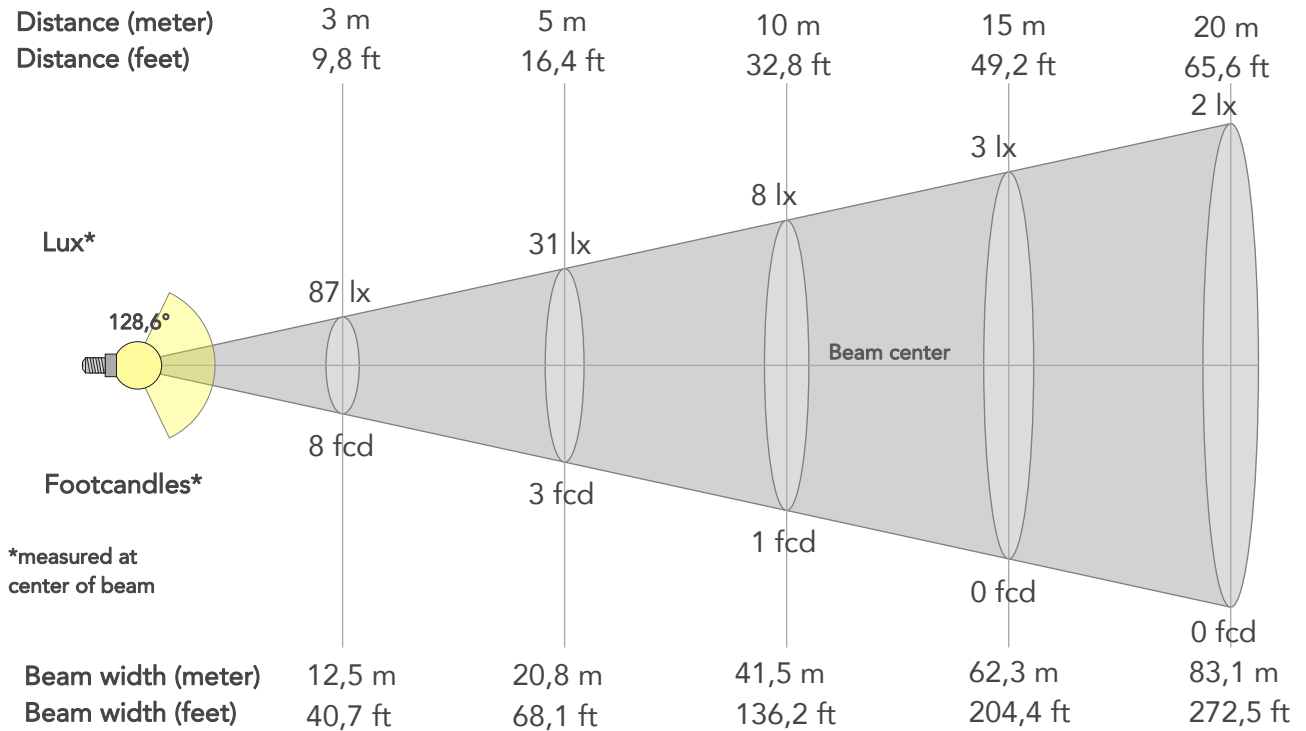

BEAM INTENSITIES AND WIDTHS

Distance	1m	2m	3m	4m	5m	7,5m	10m	15m	20m	25m	30m	40m	50m
Distance	3,3ft	6,6ft	9,8ft	13,1ft	16,4ft	24,6ft	32,8ft	49,2ft	65,6ft	82ft	98,4ft	131,2ft	164ft
Lux	779lx	195lx	87lx	49lx	31lx	14lx	8lx	3lx	2lx	1lx	1lx	0lx	0lx
Footcand.	72fcd	18fcd	8fcd	5fcd	3fcd	1fcd	1fcd	0fcd	0fcd	0fcd	0fcd	0fcd	0fcd
Beam wid.	4,2m	8,3m	12,5m	16,6m	20,8m	31,2m	41,5m	62,3m	83,1m	103,8m	124,6m	166,1m	207,7m
Beam wid.	13,7ft	27,4ft	40,7ft	54,4ft	68,1ft	102,2ft	136,2ft	204,4ft	272,5ft	340,6ft	408,7ft	545ft	681,2ft

LINEAR DISTRIBUTION DIAGRAM

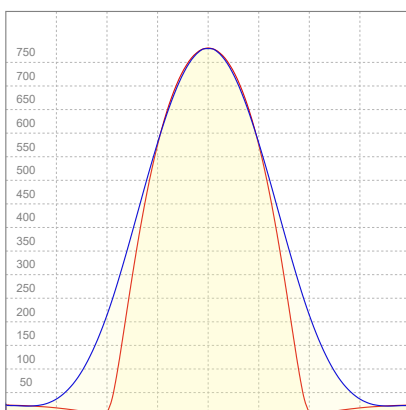

ELECTRICAL SPECIFICATIONS

Input voltage	Input current	Input power	Effeciency
225V	0,272A	58,9W	51lm/W

ISO CANDELA DIAGRAM

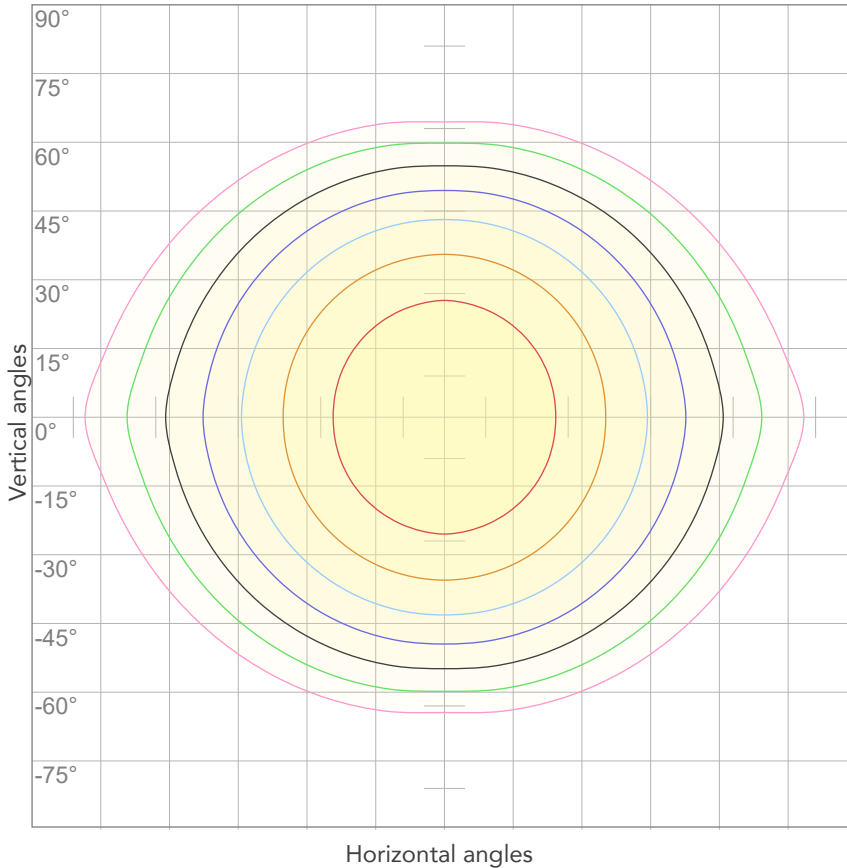

10%	78 cd
20%	156 cd
30%	234 cd
40%	312 cd
50%	390 cd
60%	468 cd
70%	546 cd
80%	623 cd

Conditions:

Number of c-planes: 4
Candela at center: 779 cd

ISO LUX DIAGRAM

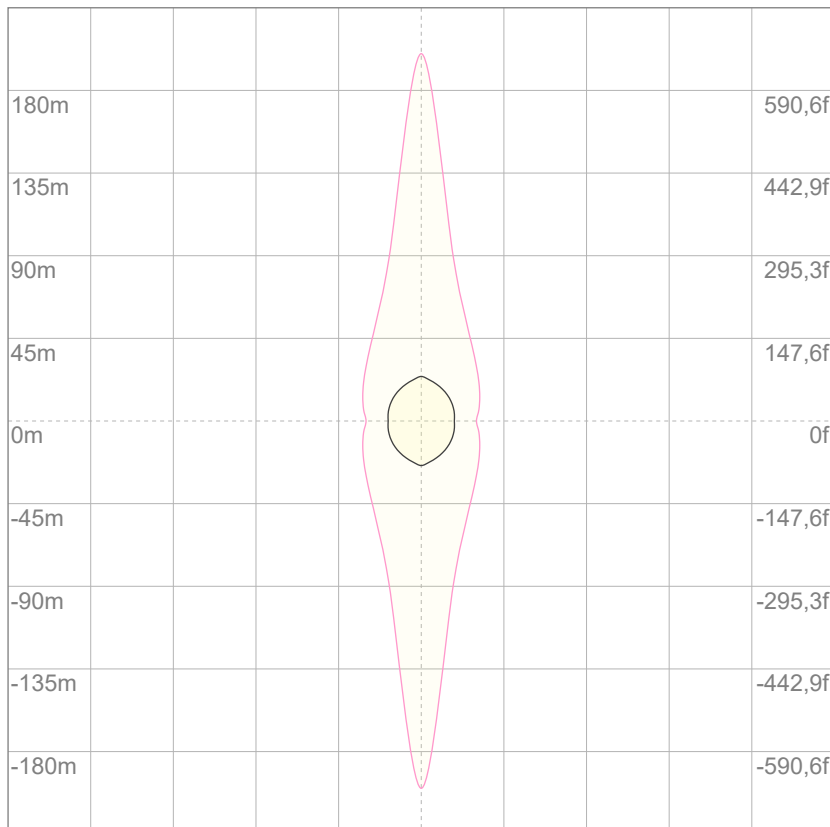

Mounting height: 10 meters (33 feet)

3%	0,234 lx
5%	0,390 lx
10%	0,779 lx
30%	2,34 lx
50%	3,90 lx

Conditions:

Number of c-planes: 4
Lux at center: 7,79 lx

Lux distribution on a surface when lamp is mounted at 10 meters from the surface.

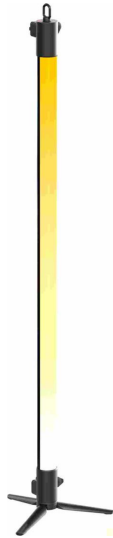

Total lumen output:

2913 lm

Peak candela output:

754 cd

Light quality:

CRI: 93,0

Color temperature:

5618 K

PRODUCT NAME:

ECLSOFTTUBE100

MEASURAMENT CONDITIONS:

Beam angle:

Native

Target:

5600K

Operator:

Paolo Carvone

Date and time:

12/01/2021 11:36:55

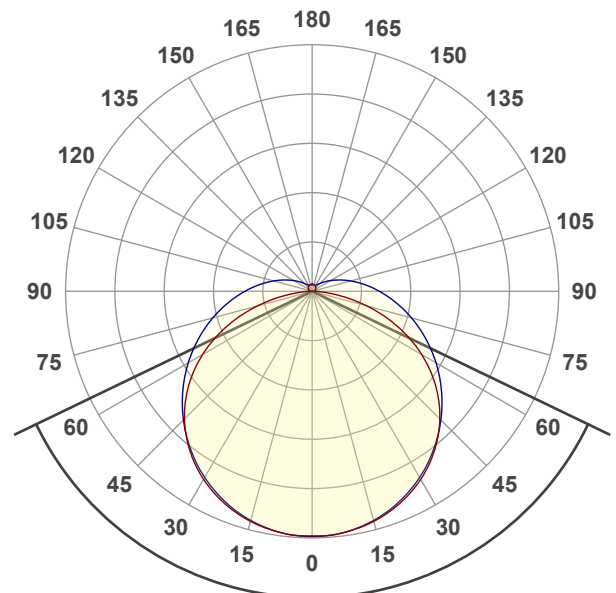

Beam angle 50%: 128,6°

Field angle 10%: 199°

Cut off angle 2.5%: 360°

Spectra

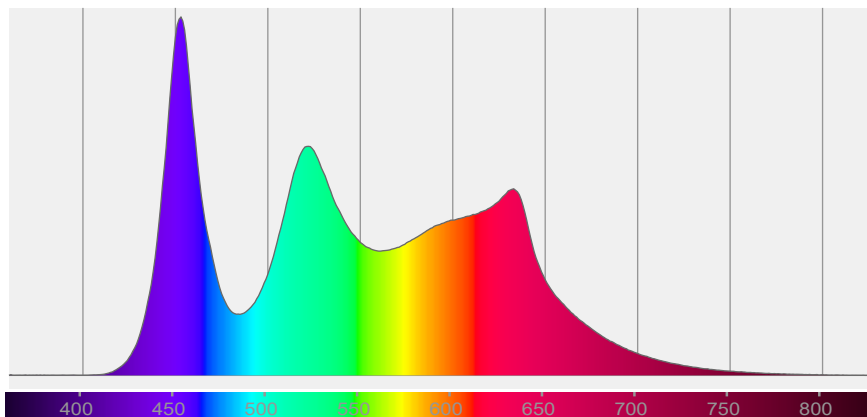

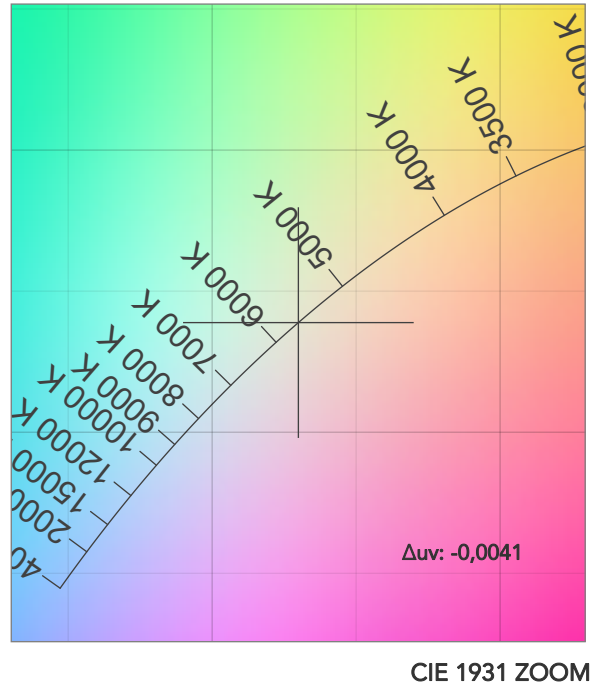
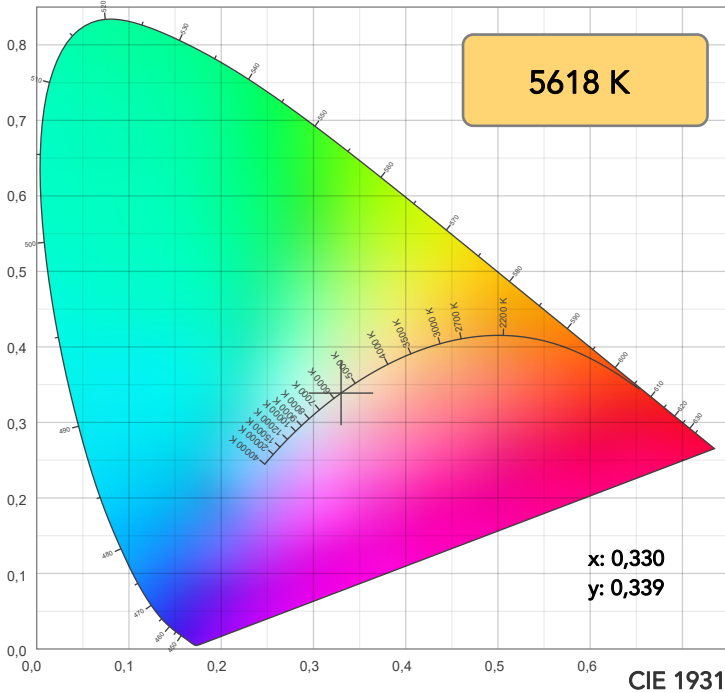

TM30: 91,3

CRI: 93,0 (R1-R8)

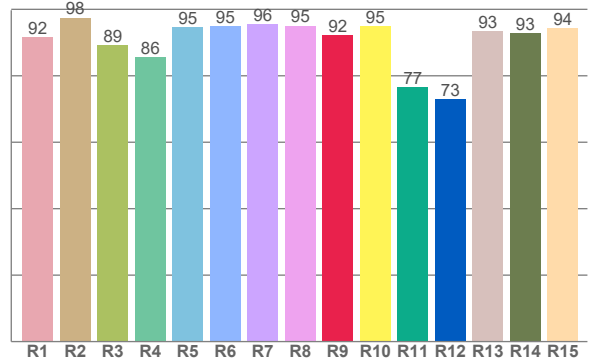
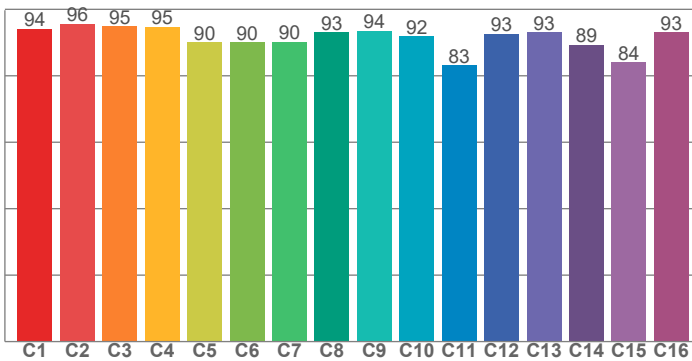

CRI R values, only R1-R8 are used to calculate final CRI value

R1	R2	R3	R4	R5	R6	R7	R8	R9	R10	R11	R12	R13	R14	R15
91,6	97,5	89,2	85,6	94,5	94,8	95,6	95,0	92,1	94,9	76,5	72,9	93,4	92,7	94,3

TM30 C values, 16 binned values out of total of 99 C values

C1	C2	C3	C4	C5	C6	C7	C8	C9	C10	C11	C12	C13	C14	C15	C16
94,2	95,6	94,9	94,7	90,0	90,1	90,2	93,1	93,6	91,8	83,1	92,6	93,1	89,3	84,1	93,1

CQS Q values

Q1	Q2	Q3	Q4	Q5	Q6	Q7	Q8	Q9	Q10	Q11	Q12	Q13	Q14	Q15
98,5	97,5	84,7	92,7	97,1	92,1	95,9	96,6	92,6	93,8	98,7	97,2	97,2	96,6	97,9

CQS: 94,1

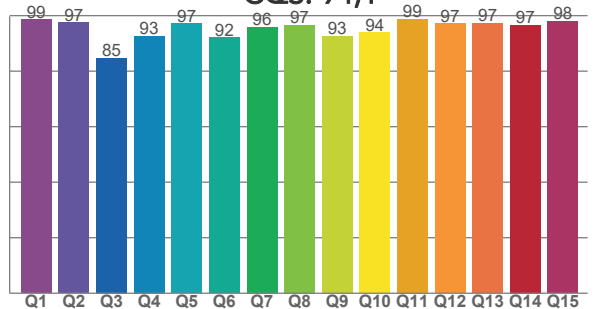

COLOR PARAMETERS

Color temperature	Color rendering index	Red component	Color fidelity	Color gamut	Color quality scale	Television lighting index	Color coordinate cie 1931	Color coordinate cie 1931	Color deviation from black body
CCT	CRI	CRI R9	TM30 Rf	TM30 Rg	CQS	TLCI	x	y	Δuv
5618 K	93,0	92,1	91,3	105,6	94,1	91	0,330	0,339	-0,0041

TM30 DETAILS

Rf 91,3
Fidelity index Rf

Rg 105,6
Gammut index

Hue Bin	R _f	Graphic shifts (%)	
		Chroma	Hue
1	94	1%	-1%
2	96	2%	0%
3	95	1%	1%
4	95	-1%	1%
5	90	-1%	2%
6	90	6%	4%
7	90	5%	2%
8	93	3%	1%
9	94	0%	3%
10	92	-1%	5%
11	83	3%	10%
12	93	3%	4%
13	93	5%	2%
14	89	5%	3%
15	84	12%	-6%
16	93	3%	0%

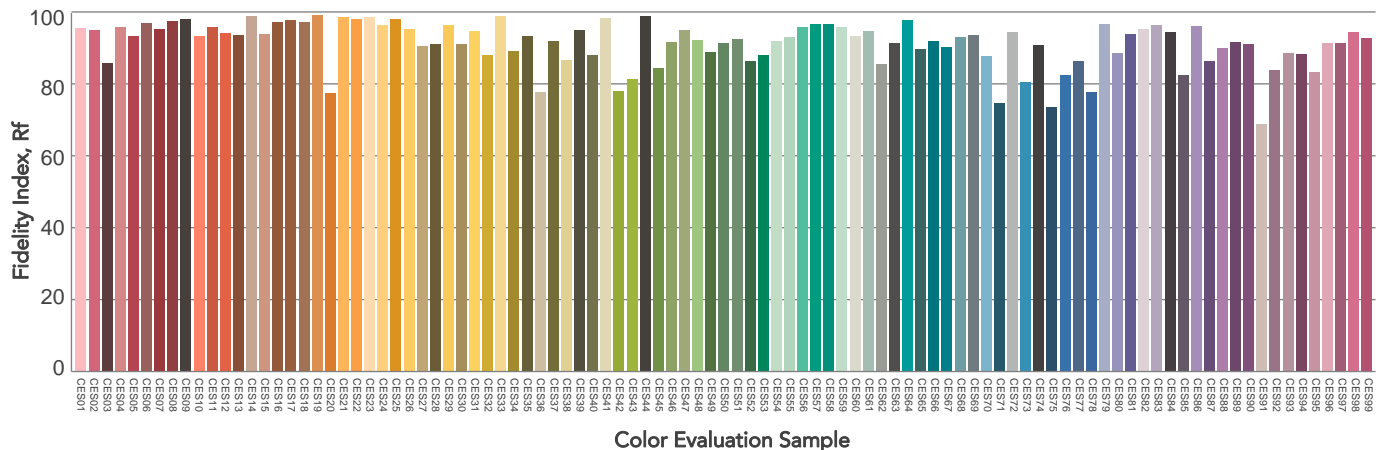
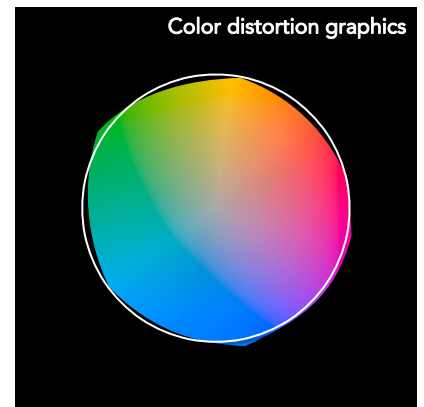
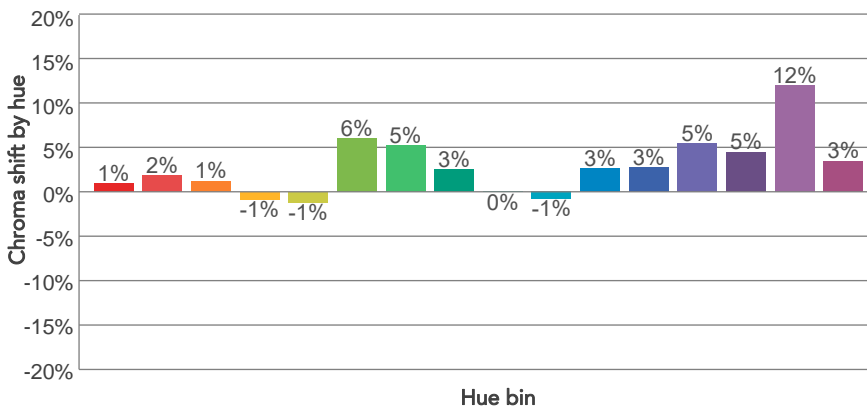
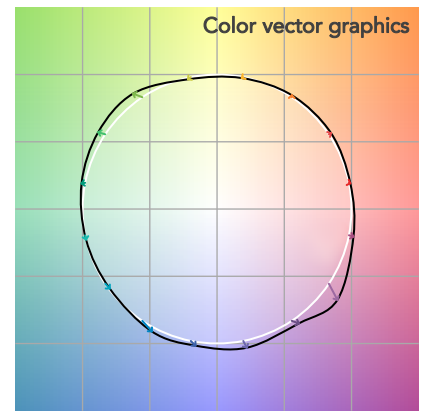
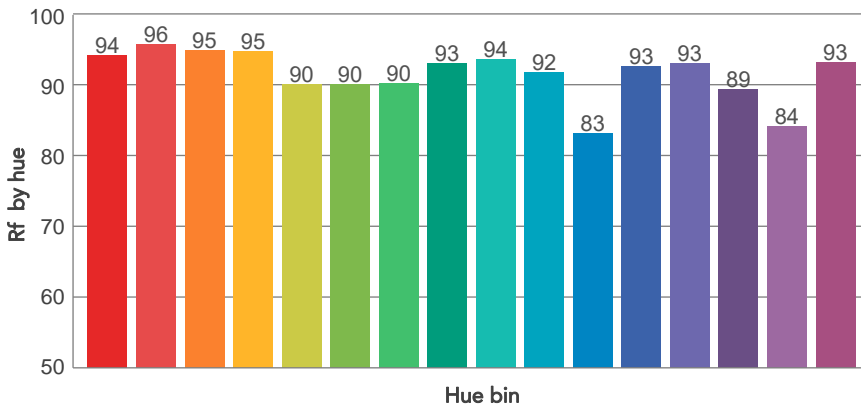
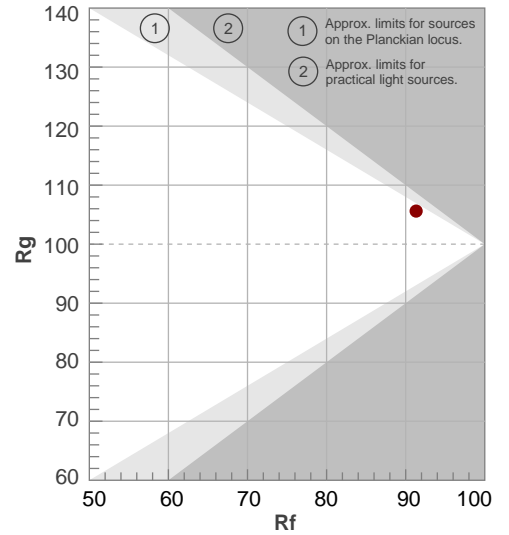

BEAM DETAILS



Beam angle 50%	Field angle 10%	Cut off angle 2,5%	Intensity ratio in 120° cone	Intensity ratio in 90° cone
128,6°	199°	360°	63,2%	41,5%

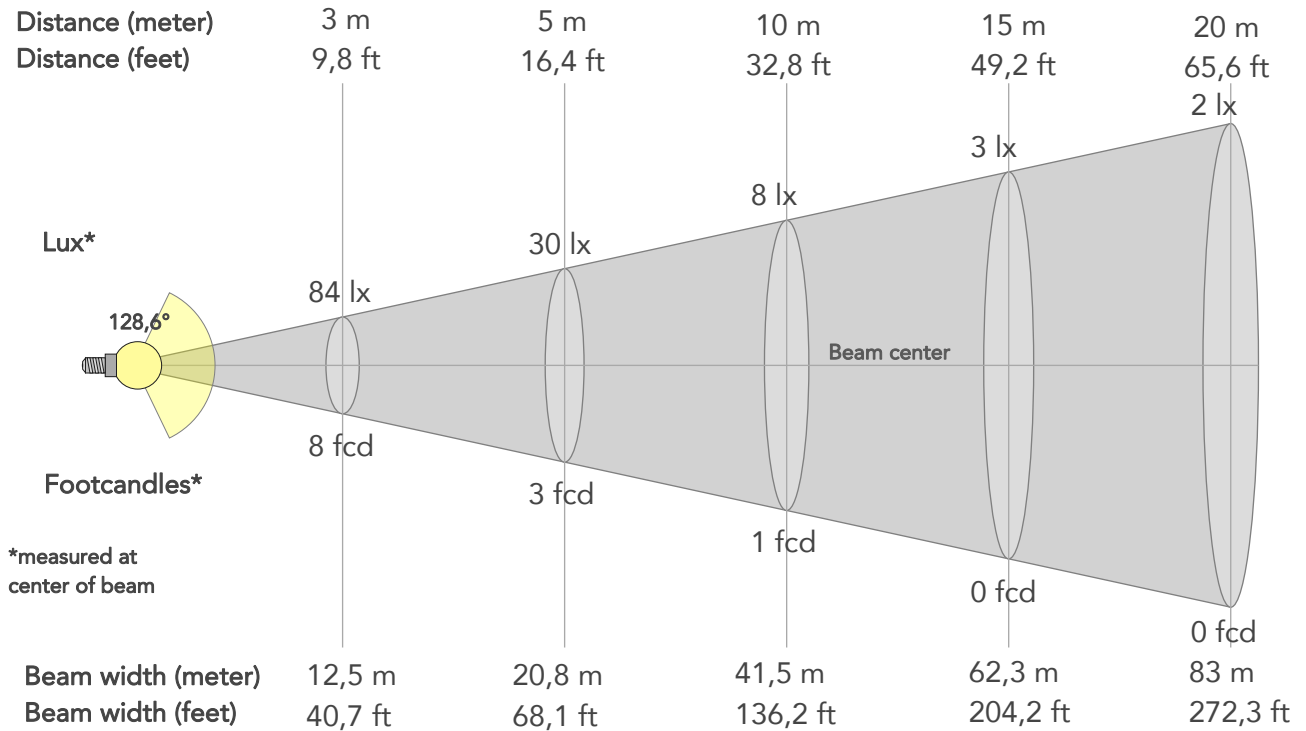

BEAM INTENSITIES AND WIDTHS

Distance	1m	2m	3m	4m	5m	7,5m	10m	15m	20m	25m	30m	40m	50m
Distance	3,3ft	6,6ft	9,8ft	13,1ft	16,4ft	24,6ft	32,8ft	49,2ft	65,6ft	82ft	98,4ft	131,2ft	164ft
Lux	754lx	188lx	84lx	47lx	30lx	13lx	8lx	3lx	2lx	1lx	1lx	0lx	0lx
Footcand.	70fcd	18fcd	8fcd	4fcd	3fcd	1fcd	1fcd	0fcd	0fcd	0fcd	0fcd	0fcd	0fcd
Beam wid.	4,2m	8,3m	12,5m	16,6m	20,8m	31,1m	41,5m	62,3m	83m	103,8m	124,5m	166m	207,6m
Beam wid.	13,7ft	27,4ft	40,7ft	54,4ft	68,1ft	102,1ft	136,2ft	204,2ft	272,3ft	340,4ft	408,5ft	544,6ft	680,8ft

LINEAR DISTRIBUTION DIAGRAM

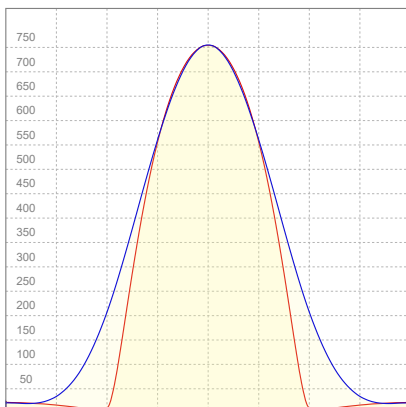

ELECTRICAL SPECIFICATIONS

Input voltage	Input current	Input power	Effeciency
225V	0,273A	58,9W	49lm/W

ISO CANDELA DIAGRAM

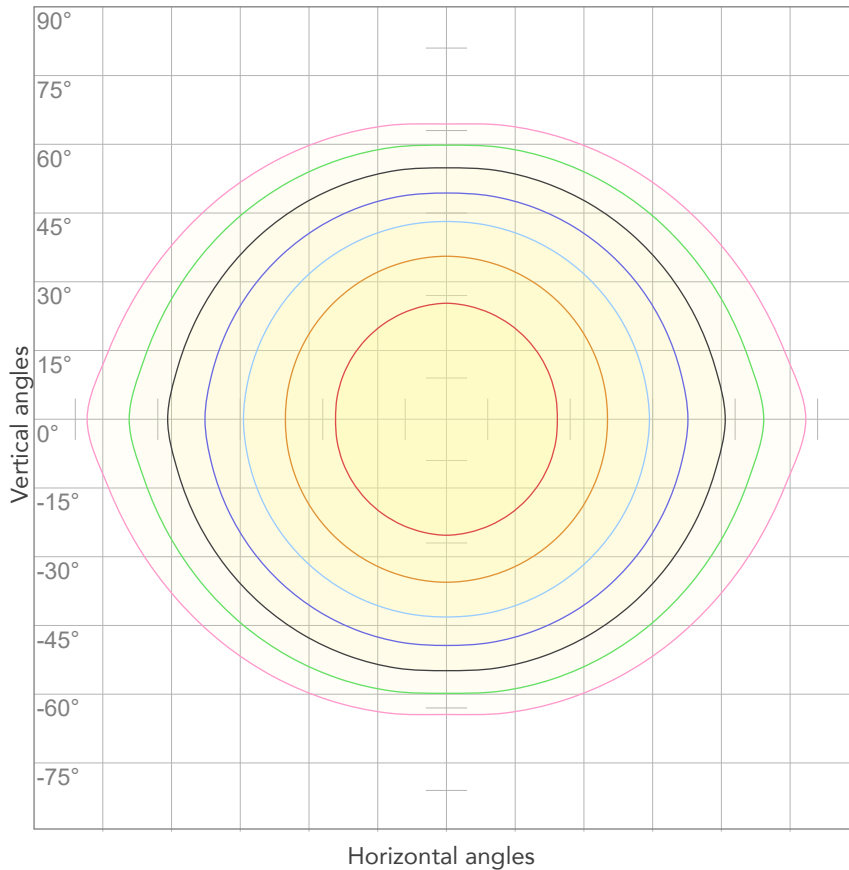

10%	75 cd
20%	151 cd
30%	226 cd
40%	302 cd
50%	377 cd
60%	452 cd
70%	528 cd
80%	603 cd

Conditions:

Number of c-planes: 4
Candela at center: 754 cd

ISO LUX DIAGRAM

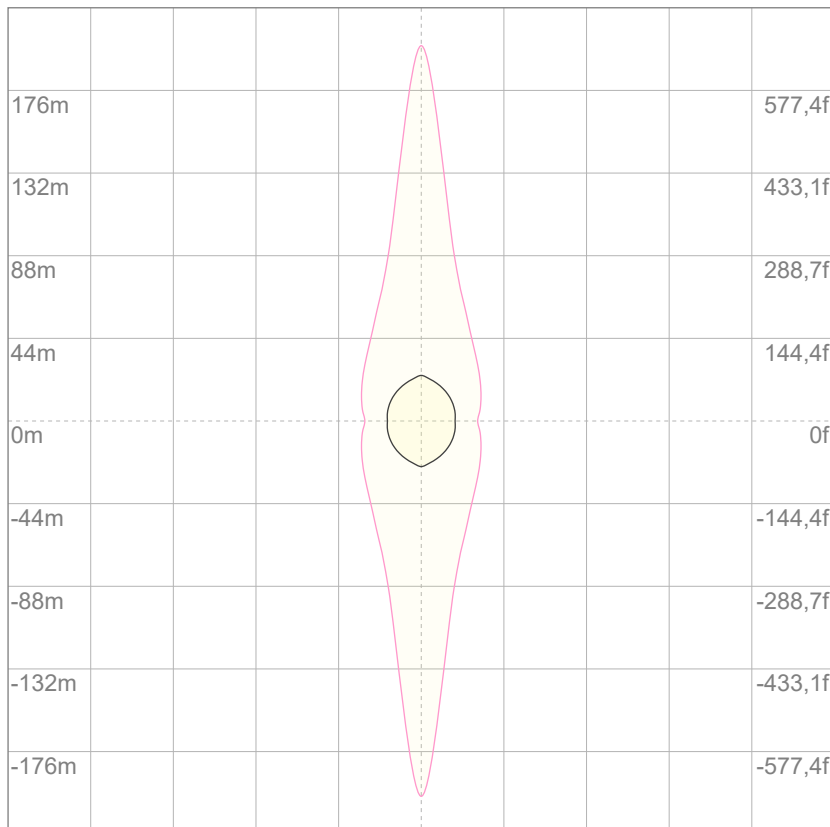

3%	0,226 lx
5%	0,377 lx
10%	0,754 lx
30%	2,26 lx
50%	3,77 lx

Conditions:

Number of c-planes: 4
Lux at center: 7,54 lx

Lux distribution on a surface when lamp is mounted at 10 meters from the surface.

Mounting height: 10 meters (33 feet)

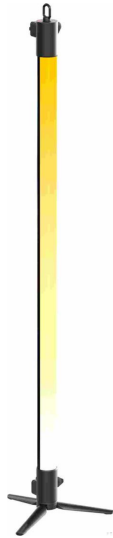

Total lumen output:

2888 lm

Peak candela output:

747 cd

Light quality:

CRI: 93,0

Color temperature:

6005 K

PRODUCT NAME:

ECLSOFTTUBE100

MEASURAMENT CONDITIONS:

Beam angle:

Native

Target:

6000K

Operator:

Paolo Carvone

Date and time:

12/01/2021 11:39:16

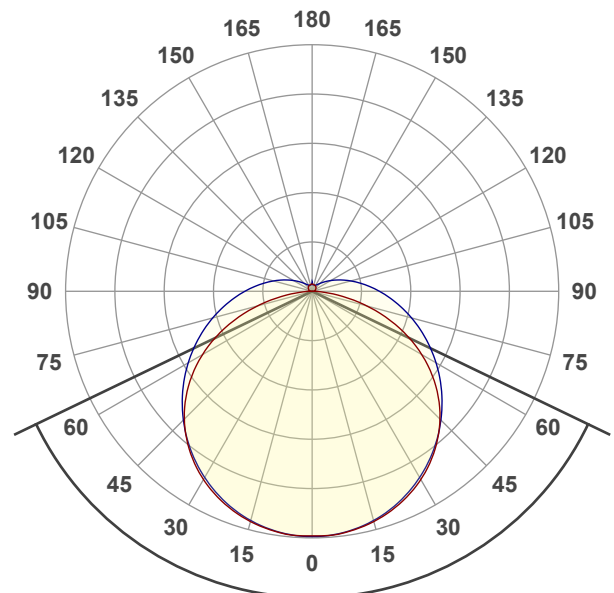

Beam angle 50%: 128,6°

Field angle 10%: 199,2°

Cut off angle 2.5%: 360°

Spectra

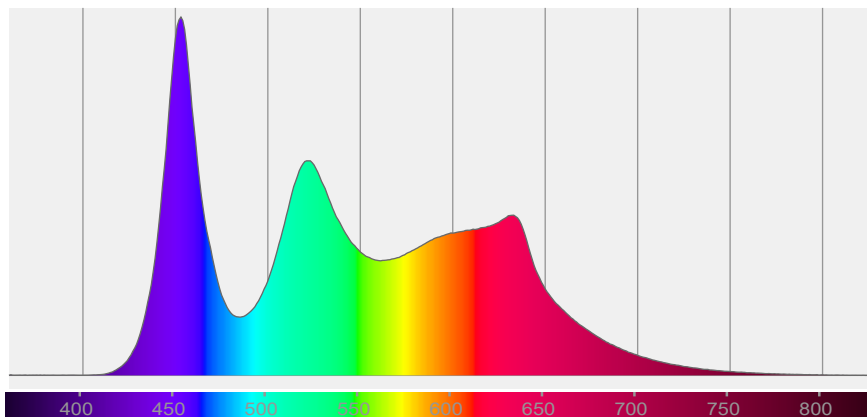

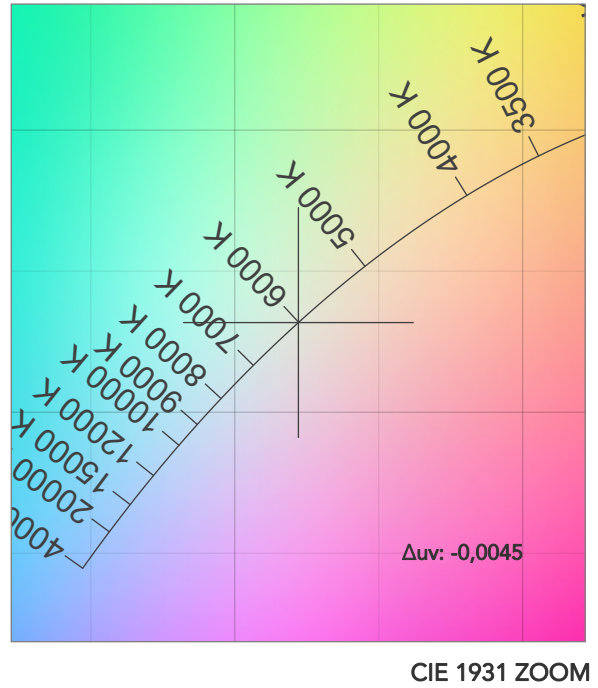
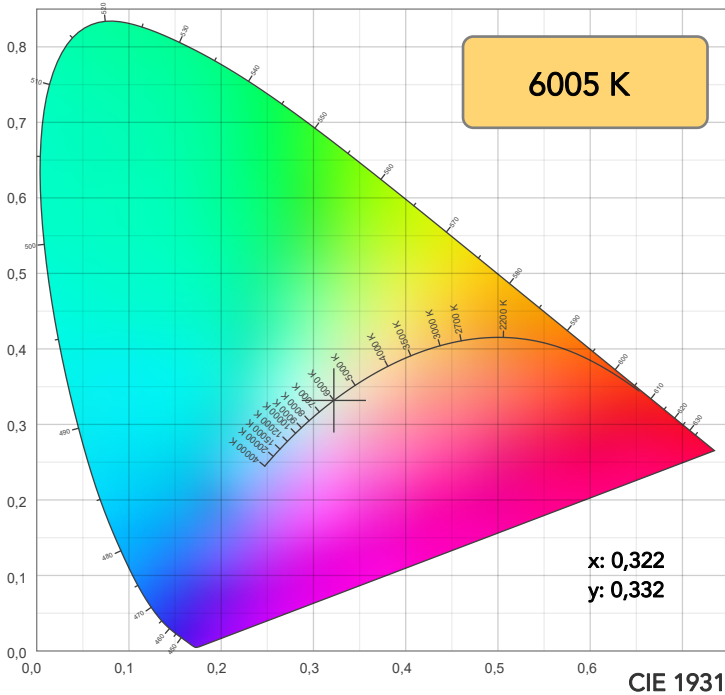

TM30: 90,9

CRI: 93,0 (R1-R8)

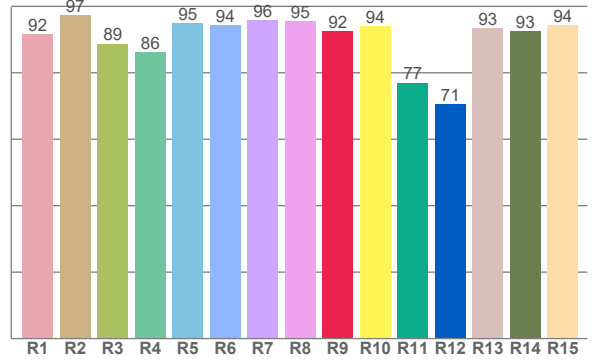
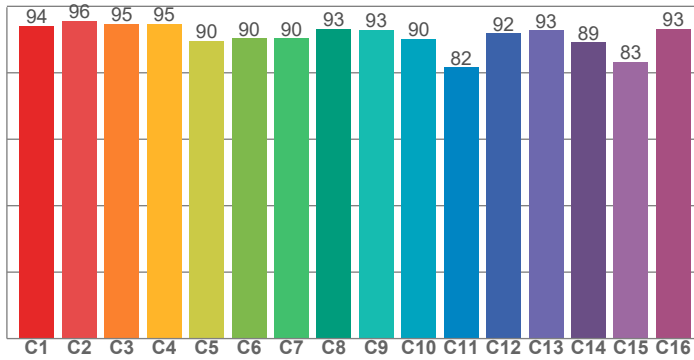

CRI R values, only R1-R8 are used to calculate final CRI value

R1	R2	R3	R4	R5	R6	R7	R8	R9	R10	R11	R12	R13	R14	R15
91,7	97,2	88,7	86,1	95,0	94,3	95,8	95,5	92,5	94,1	77,0	70,6	93,5	92,5	94,2

TM30 C values, 16 binned values out of total of 99 C values

C1	C2	C3	C4	C5	C6	C7	C8	C9	C10	C11	C12	C13	C14	C15	C16
94,1	95,7	94,8	94,7	89,5	90,4	90,4	93,3	92,9	90,2	81,7	91,9	92,7	89,1	83,3	93,2

CQS Q values

Q1	Q2	Q3	Q4	Q5	Q6	Q7	Q8	Q9	Q10	Q11	Q12	Q13	Q14	Q15
98,0	97,3	83,8	90,9	98,4	93,0	96,2	96,5	92,1	93,2	99,5	97,8	97,6	96,5	97,8

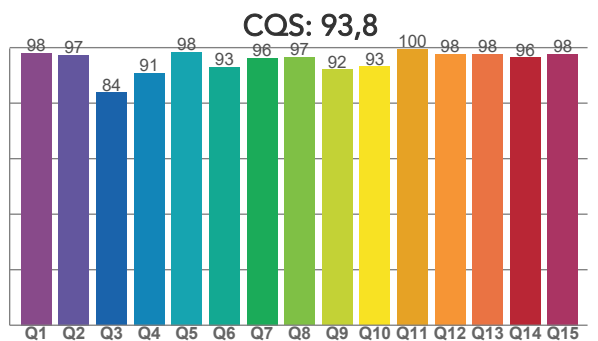

COLOR PARAMETERS

Color temperature	Color rendering index	Red component	Color fidelity	Color gamut	Color quality scale	Television lighting index	Color coordinate cie 1931	Color coordinate cie 1931	Color deviation from black body
CCT	CRI	CRI R9	TM30 Rf	TM30 Rg	CQS	TLCI	x	y	Δuv
6005 K	93,0	92,5	90,9	105,5	93,8	91	0,322	0,332	-0,0045

TM30 DETAILS

Rf 90,9
Fidelity index Rf

Rg 105,5
Gammut index

Hue Bin	R _f	Graphic shifts (%)	
		Chroma	Hue
1	94	1%	0%
2	96	2%	0%
3	95	1%	1%
4	95	-1%	2%
5	90	-2%	2%
6	90	5%	4%
7	90	6%	1%
8	93	2%	2%
9	93	0%	4%
10	90	-1%	6%
11	82	3%	11%
12	92	3%	5%
13	93	6%	2%
14	89	5%	4%
15	83	13%	-7%
16	93	3%	0%

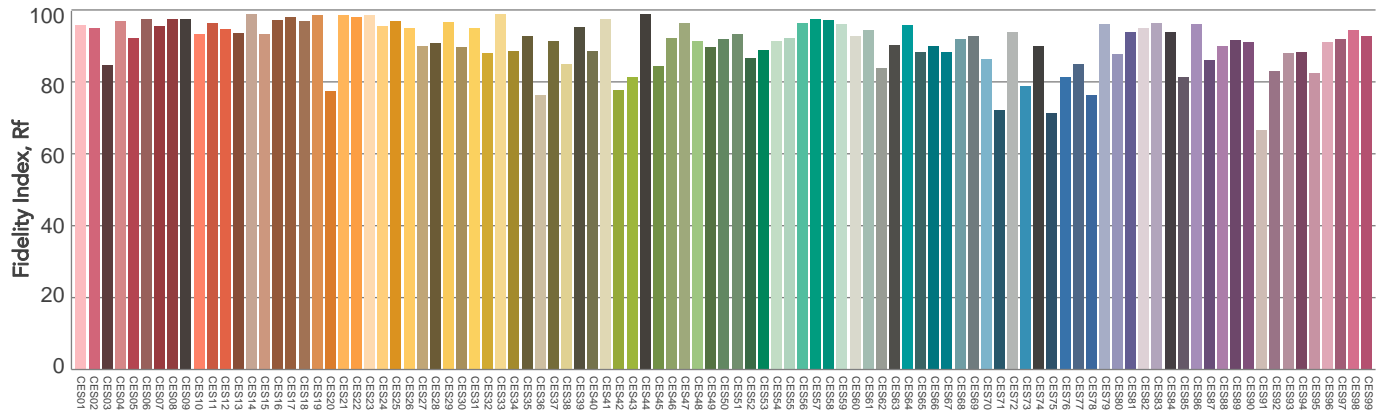
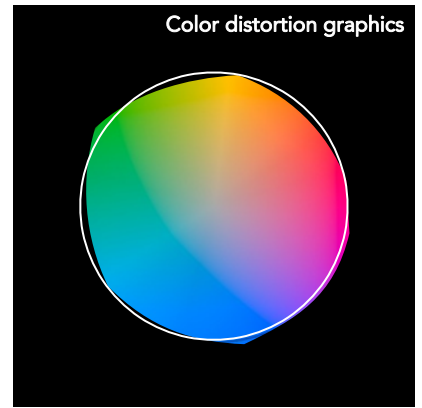
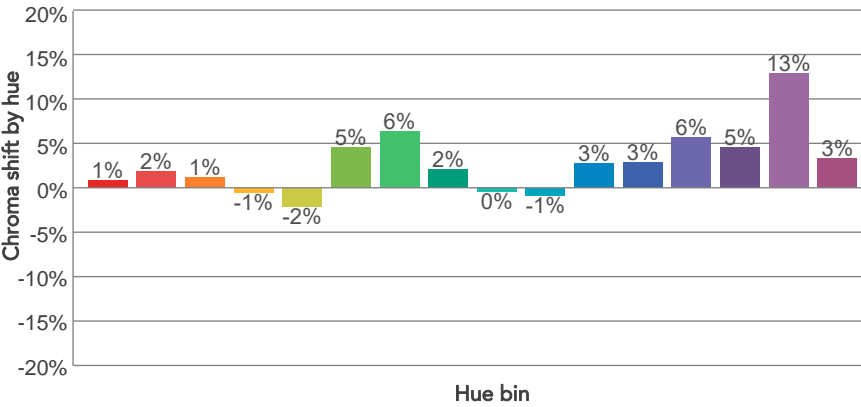
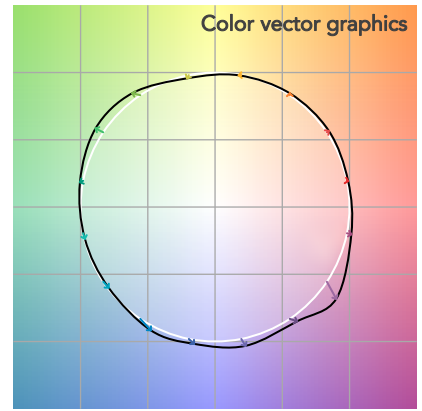
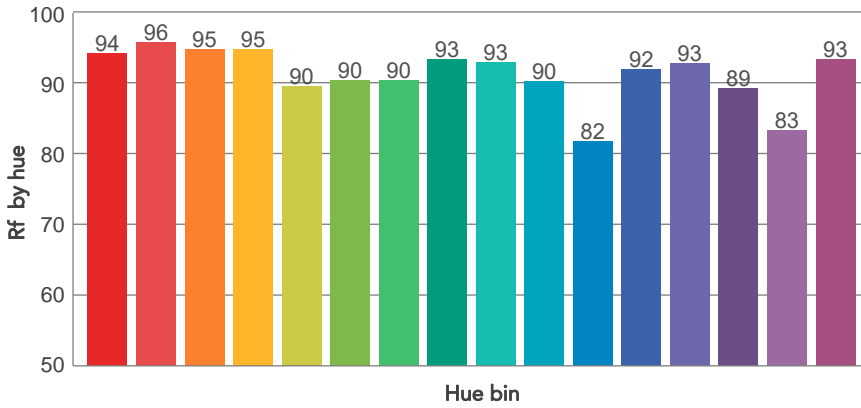
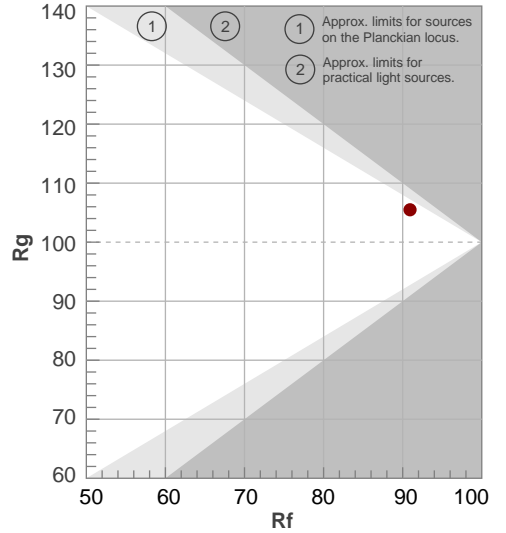

BEAM DETAILS



Beam angle 50%	Field angle 10%	Cut off angle 2,5%	Intensity ratio in 120° cone	Intensity ratio in 90° cone
128,6°	199,2°	360°	63,2%	41,5%

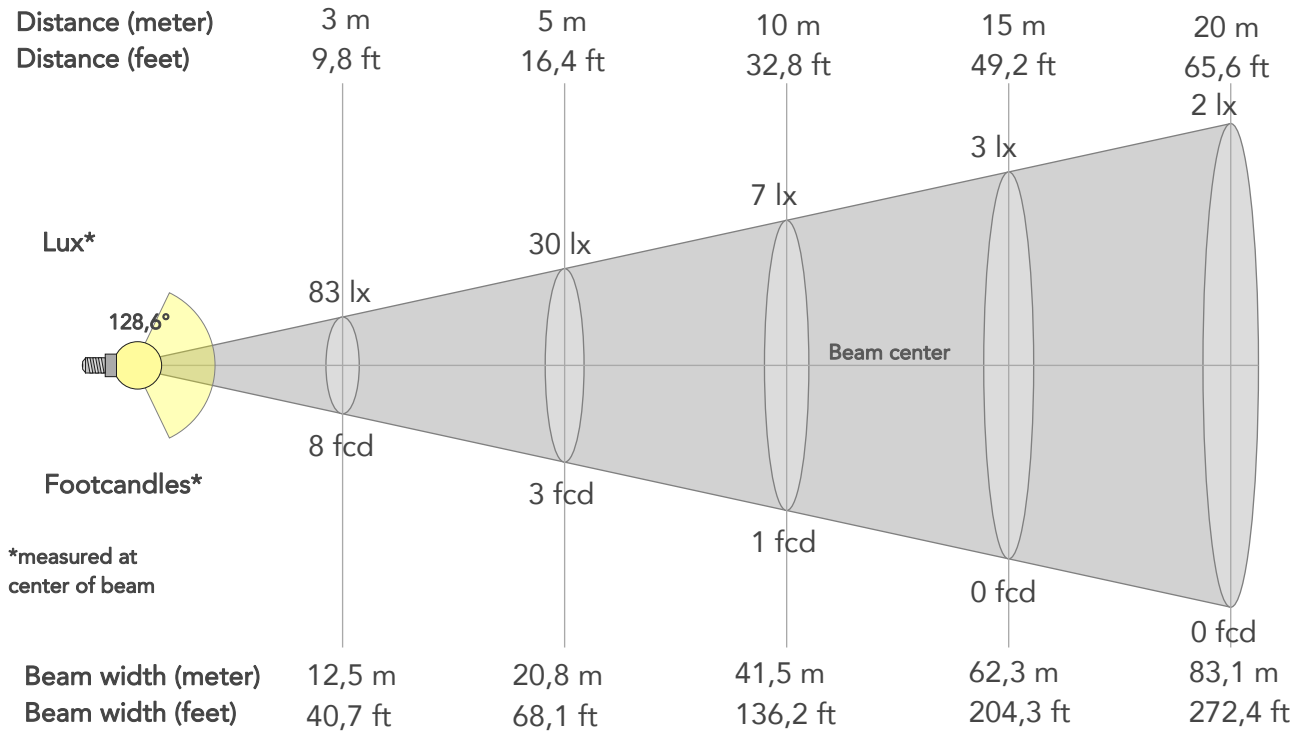

BEAM INTENSITIES AND WIDTHS

Distance	1m	2m	3m	4m	5m	7,5m	10m	15m	20m	25m	30m	40m	50m
Distance	3,3ft	6,6ft	9,8ft	13,1ft	16,4ft	24,6ft	32,8ft	49,2ft	65,6ft	82ft	98,4ft	131,2ft	164ft
Lux	747lx	187lx	83lx	47lx	30lx	13lx	7lx	3lx	2lx	1lx	1lx	0lx	0lx
Footcand.	69fcd	17fcd	8fcd	4fcd	3fcd	1fcd	1fcd	0fcd	0fcd	0fcd	0fcd	0fcd	0fcd
Beam wid.	4,2m	8,3m	12,5m	16,6m	20,8m	31,1m	41,5m	62,3m	83,1m	103,8m	124,6m	166,1m	207,7m
Beam wid.	13,7ft	27,4ft	40,7ft	54,4ft	68,1ft	102,2ft	136,2ft	204,3ft	272,4ft	340,5ft	408,7ft	544,9ft	681,1ft

LINEAR DISTRIBUTION DIAGRAM

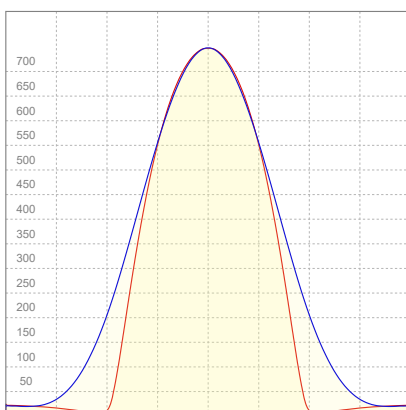

ELECTRICAL SPECIFICATIONS

Input voltage	Input current	Input power	Effeciency
225V	0,272A	59,0W	49lm/W

ISO CANDELA DIAGRAM

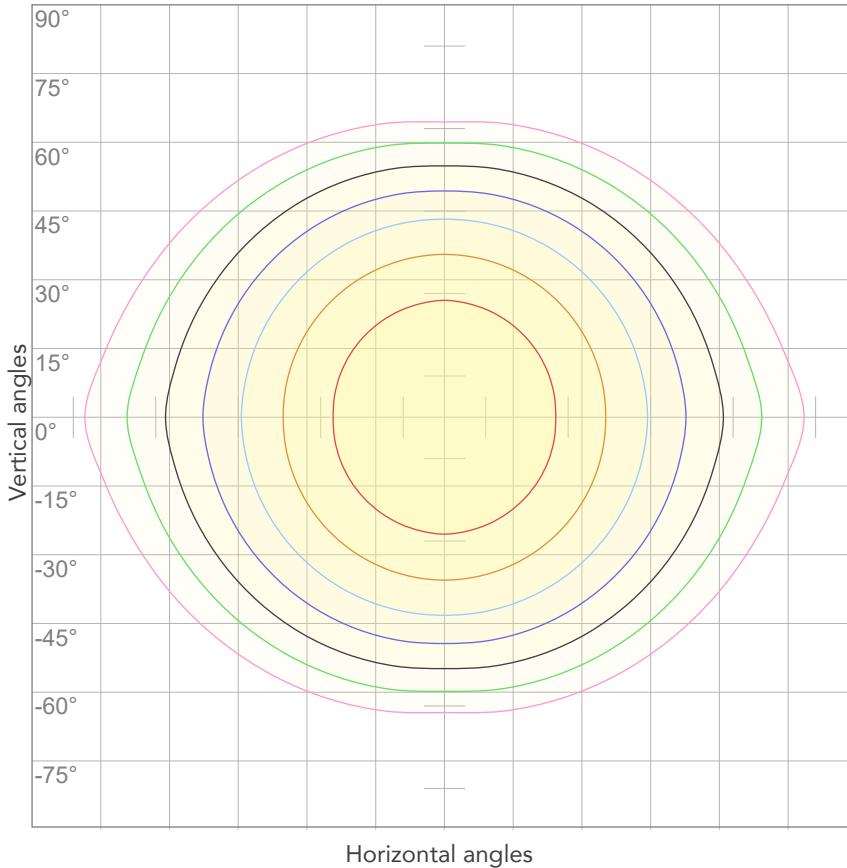

10%	75 cd
20%	149 cd
30%	224 cd
40%	299 cd
50%	373 cd
60%	448 cd
70%	523 cd
80%	597 cd

Conditions:

Number of c-planes: 4

Candela at center: 747 cd

ISO LUX DIAGRAM

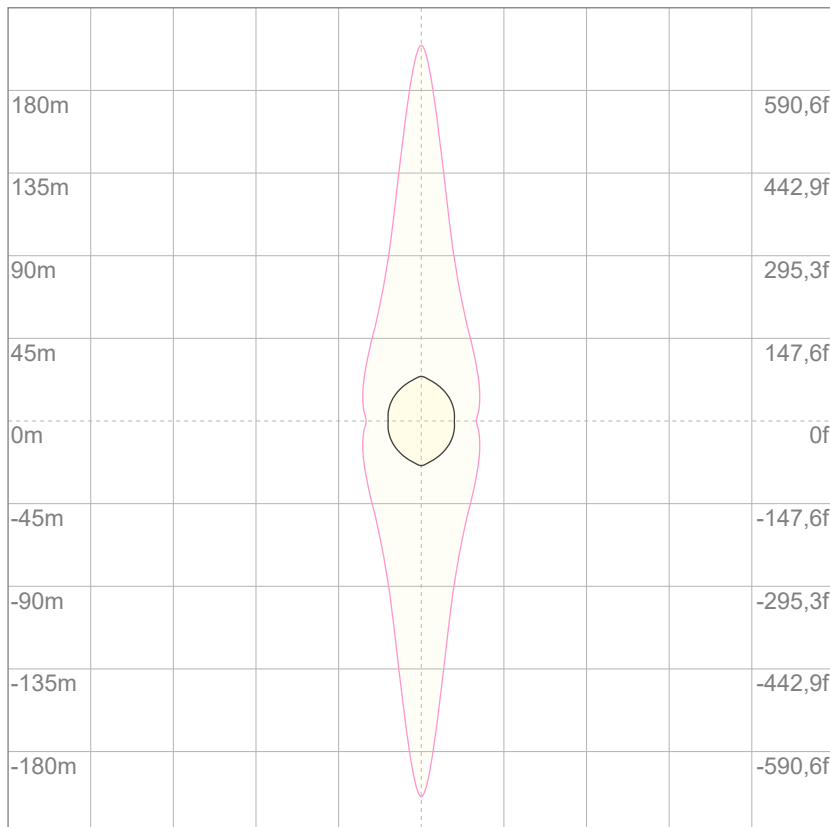

Mounting height: 10 meters (33 feet)

3%	0,224 lx
5%	0,373 lx
10%	0,747 lx
30%	2,24 lx
50%	3,73 lx

Conditions:

Number of c-planes: 4

Lux at center: 7,47 lx

Lux distribution on a surface when lamp is mounted at 10 meters from the surface.