

# Photometric Test Report



## ECLEXPFL300FC

300W Full Colour RGB+Warm White  
asymmetric LED floodlight

## CONTENTS

Table of contents	2
Testing process	3
<b>Preset</b>	
Full On	4
Red	7
Green	10
Blue	13
White	16
2800K	19
3200K	24
4000K	29
5600K	34
6000k	39

## TESTING PROCESS

Prolights has its own optical testing laboratory in order to provide accurate photometric reports for its lighting products. The testing laboratory contains certain variety of precise lighting measurement systems that ensure an optimal reading of all the characteristic parameters of the lighting devices. All measurements are made at a controlled room temperature of 20°C without any external light sources. This photometric report is obtained through the data measured by a high precision measurement system and analyzed by a dedicate software.

### **Prolights measurement instrument**

Prolights measurement instrument is a complete measurement system for any light source. It's equipped with two-axis goniometer, that enables to measure the full 3D distribution field of the light source. This instrument measures the light intensity, the beam angle and the most significative colors parameters, like color temperature, spectral distribution, CRI, CQS, TM-30 with a very high accuracy rate.

**Please Note:** All measurements are made with light source at operating temperature. Before starting the measurement, the instrument analyzes the process of the light source during the heating phase. The measuring process of all the parameters begins only when the light emission is stable, that is with a variation of less than 0.5% in a 15 minutes time frame.

### **Prolights measurement software**

The software provides user friendly interface for the operator who does the measurements, and it also analyzes and processes all the collected data by the instrument. With this software it is possible to see the measured data in real-time and it is possible to examine all the measured data and graphics afterwards as well. All information is collected in a specific Prolights template, and the software creates also IES and LDT files, which are widely used to transfer the photometric data, and to develop lighting system.

Additionally, the fixtures are rechecked using various hand-held instruments like Sekonic C-700 and Gossen Mavospec Base, this is done to ensure, that the data in the photometric report are as accurate as possible.

Total lumen output:

8932 lm

Peak candela output:

5317 cd



**PRODUCT NAME:**

ECLEXPOFL300 FC

**MEASUREMENT CONDITIONS:**

Beam angle:

Asymmetric

Target:

Full On

Operator:

Salvatore Giglio

Date and time:

29/03/2023 16:17:48

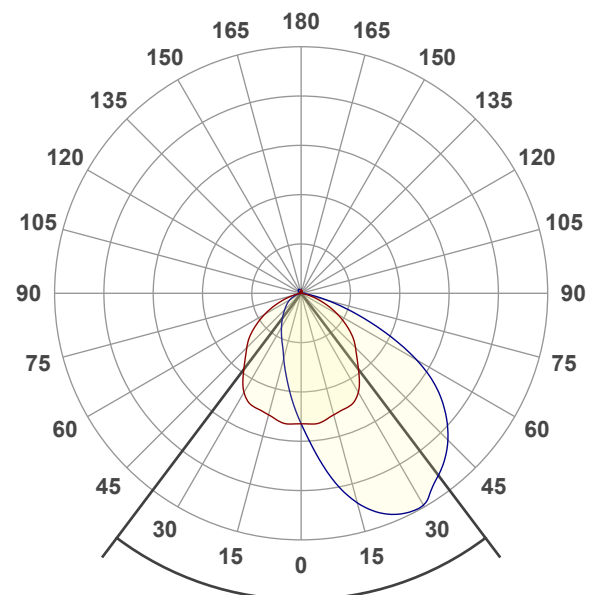

Beam angle 50%: 74°

Field angle 10%: 128,8°

Cut off angle 2.5%: 152,9°

Spectra

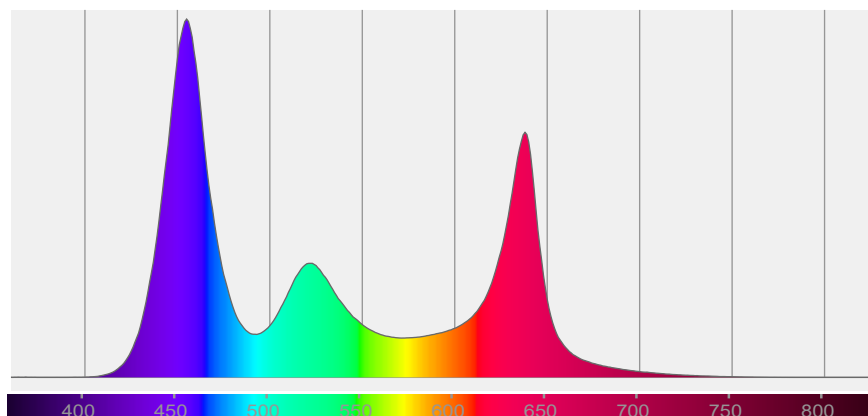

# BEAM DETAILS



Beam angle 50%	Field angle 10%	Cut off angle 2,5%	Intensity ratio in 120° cone	Intensity ratio in 90° cone
74°	128,8°	152,9°	82,4%	54,5%

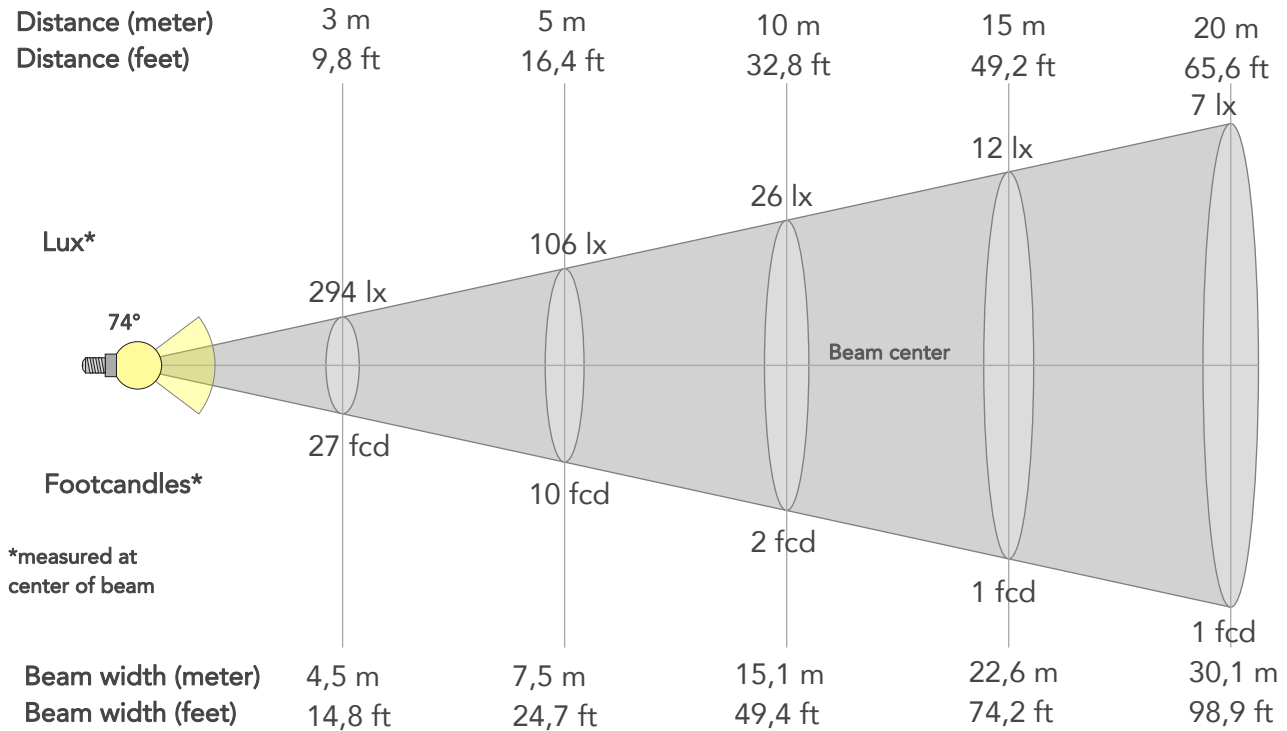

## BEAM INTENSITIES AND WIDTHS

Distance	1m	2m	3m	4m	5m	7,5m	10m	15m	20m	25m	30m	40m	50m
Distance	3,3ft	6,6ft	9,8ft	13,1ft	16,4ft	24,6ft	32,8ft	49,2ft	65,6ft	82ft	98,4ft	131,2ft	164ft
Lux	2648lx	662lx	294lx	166lx	106lx	47lx	26lx	12lx	7lx	4lx	3lx	2lx	1lx
Footcand.	246fcd	62fcd	27fcd	15fcd	10fcd	4fcd	2fcd	1fcd	1fcd	0fcd	0fcd	0fcd	0fcd
Beam wid.	1,5m	3m	4,5m	6m	7,5m	11,3m	15,1m	22,6m	30,1m	37,7m	45,2m	60,3m	75,4m
Beam wid.	5ft	9,9ft	14,8ft	19,7ft	24,7ft	37,1ft	49,4ft	74,2ft	98,9ft	123,6ft	148,3ft	197,8ft	247,2ft

## LINEAR DISTRIBUTION DIAGRAM

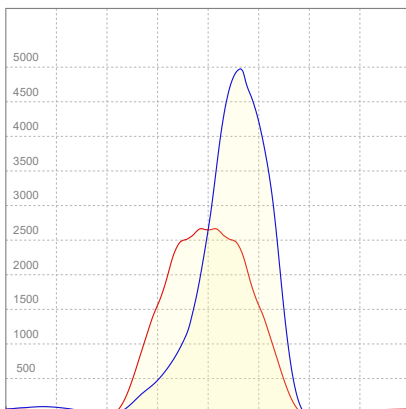

## ELECTRICAL SPECIFICATIONS

Input voltage	Input current	Input power	Effeciency
226V	1,29A	282W	32lm/W

Power FC
0,97

## ISO CANDELA DIAGRAM

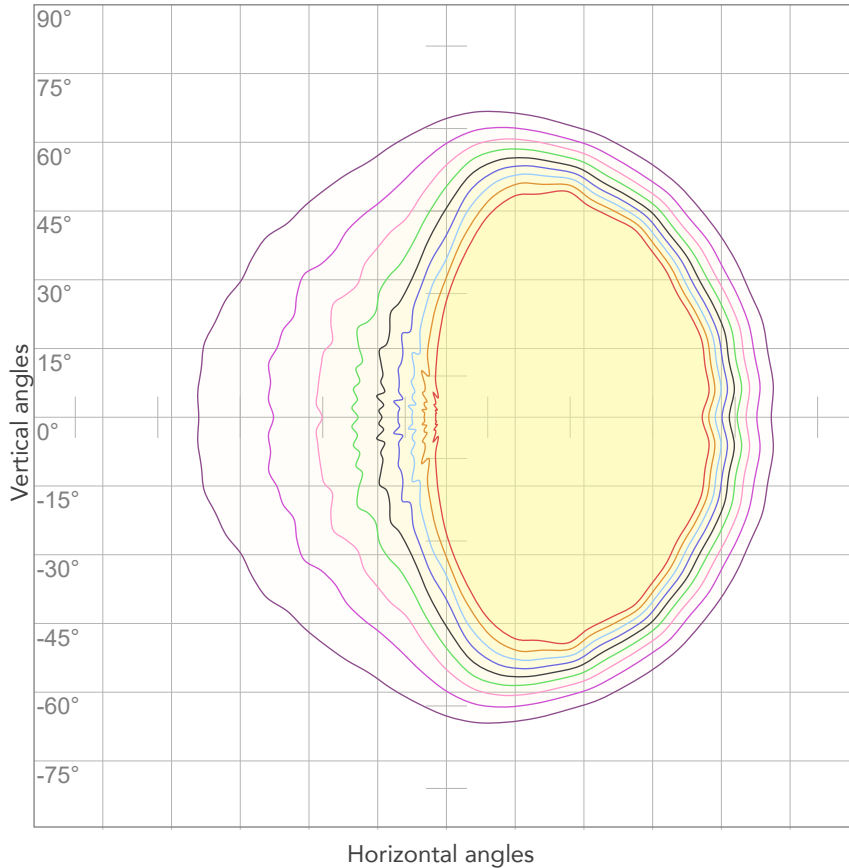

10%	265 cd
20%	530 cd
30%	795 cd
40%	1059 cd
50%	1324 cd
60%	1589 cd
70%	1854 cd
80%	2119 cd

Conditions:

Number of c-planes: 64

Candela at center: 2648 cd

## ISO LUX DIAGRAM

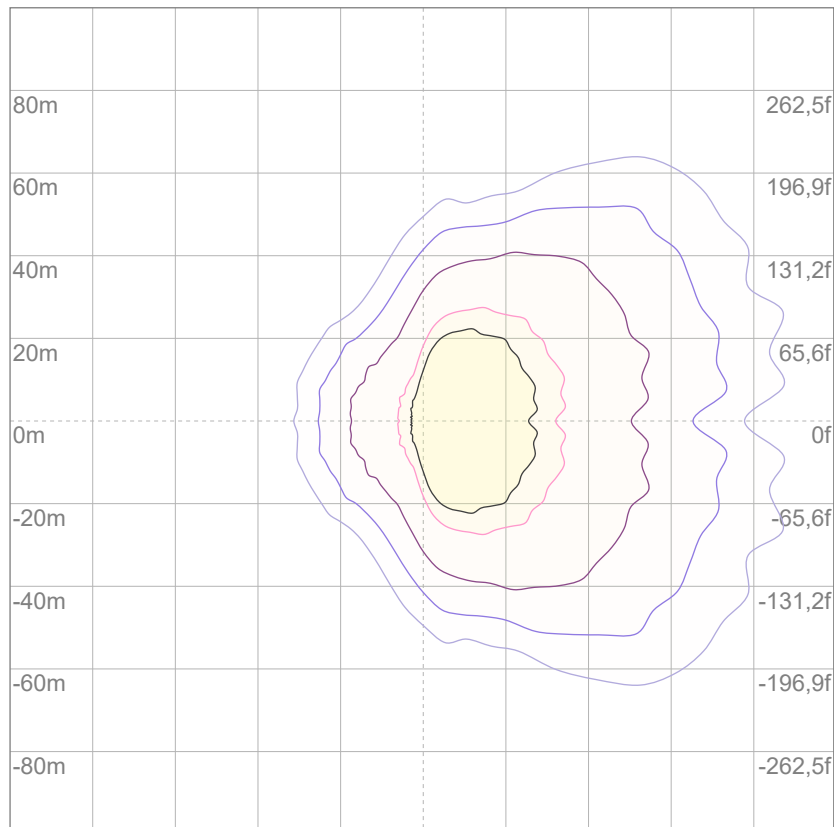

Mounting height: 10 meters (33 feet)

3%	0,795 lx
5%	1,32 lx
10%	2,65 lx
30%	7,95 lx
50%	13,2 lx

Conditions:

Number of c-planes: 64

Lux at center: 26,5 lx

*Lux distribution on a surface when lamp is mounted at 10 meters from the surface.*

Total lumen output:

4335 lm

Peak candela output:

2544 cd



**PRODUCT NAME:**

ECLEXPFL300 FC

**MEASUREMENT CONDITIONS:**

Beam angle:

Asymmetric

Target:

Red

Operator:

Salvatore Giglio

Date and time:

29/03/2023 16:54:57

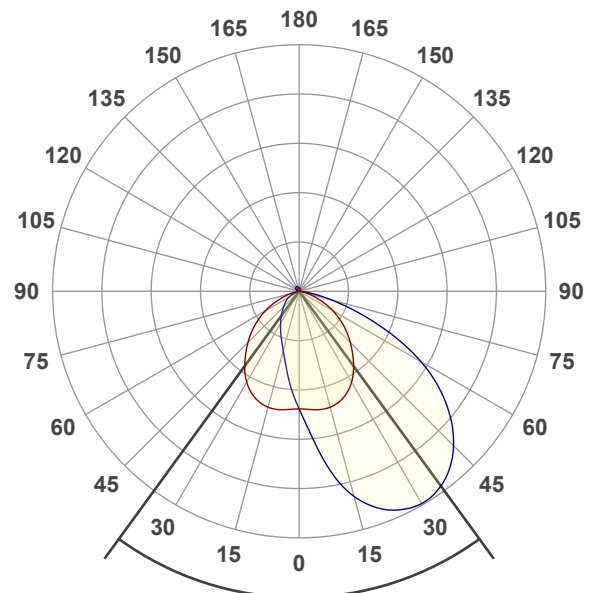

Beam angle 50%: 72,1°

Field angle 10%: 128,2°

Cut off angle 2.5%: 172°

Spectra

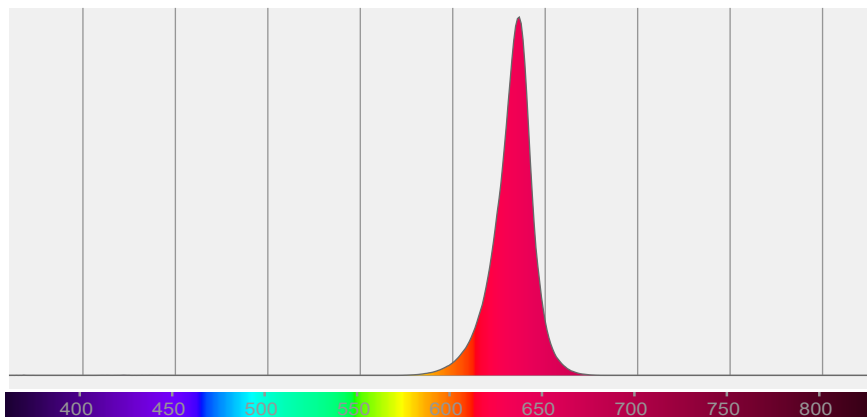

# BEAM DETAILS



Beam angle 50%	Field angle 10%	Cut off angle 2,5%	Intensity ratio in 120° cone	Intensity ratio in 90° cone
72,1°	128,2°	172°	82,1%	54,3%

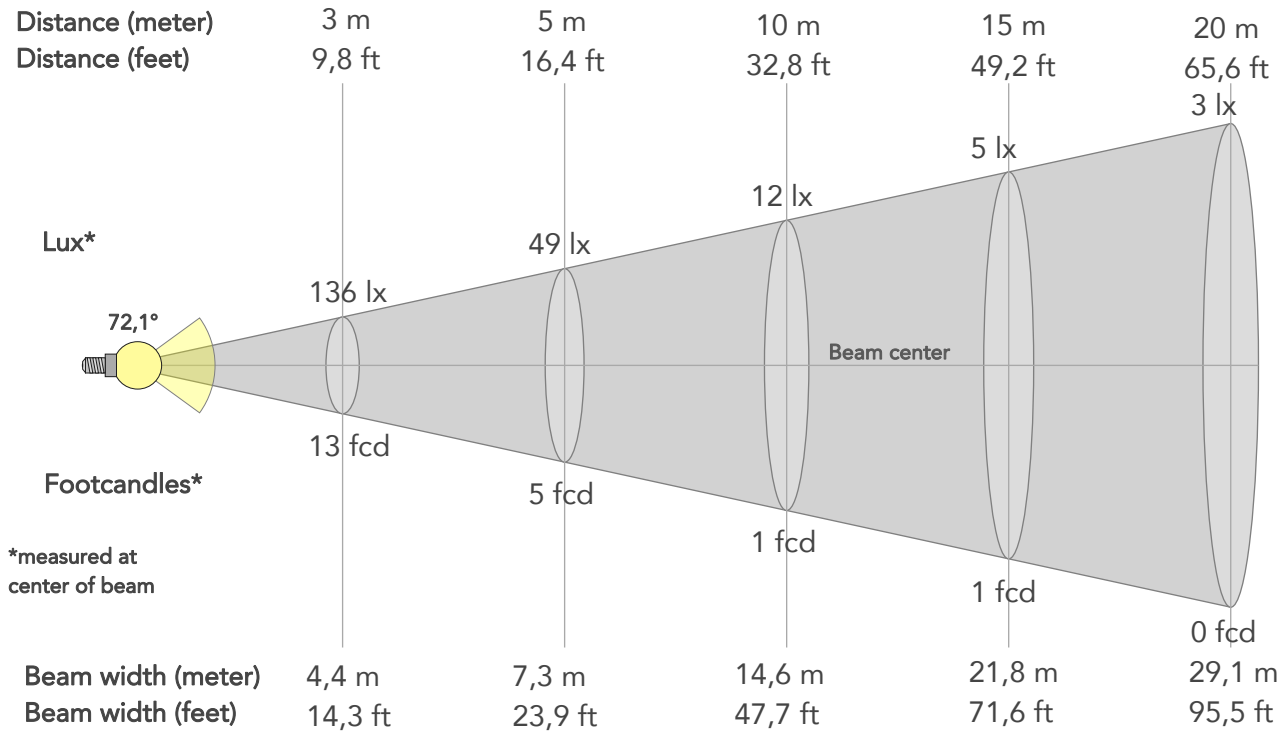

## BEAM INTENSITIES AND WIDTHS

Distance	1m	2m	3m	4m	5m	7,5m	10m	15m	20m	25m	30m	40m	50m
Distance	3,3ft	6,6ft	9,8ft	13,1ft	16,4ft	24,6ft	32,8ft	49,2ft	65,6ft	82ft	98,4ft	131,2ft	164ft
Lux	1221lx	305lx	136lx	76lx	49lx	22lx	12lx	5lx	3lx	2lx	1lx	1lx	0lx
Footcand.	113fcd	28fcd	13fcd	7fcd	5fcd	2fcd	1fcd	1fcd	0fcd	0fcd	0fcd	0fcd	0fcd
Beam wid.	1,5m	2,9m	4,4m	5,8m	7,3m	10,9m	14,6m	21,8m	29,1m	36,4m	43,7m	58,2m	72,8m
Beam wid.	4,8ft	9,6ft	14,3ft	19,1ft	23,9ft	35,8ft	47,7ft	71,6ft	95,5ft	119,4ft	143,2ft	191ft	238,7ft

## LINEAR DISTRIBUTION DIAGRAM

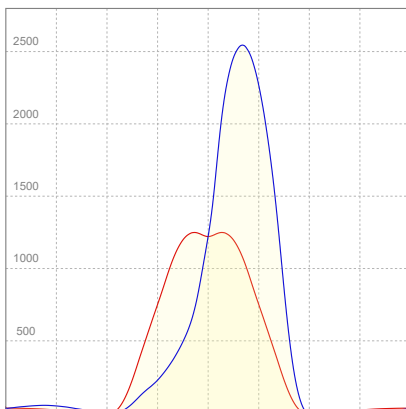

## ELECTRICAL SPECIFICATIONS

Input voltage	Input current	Input power	Effeciency
224V	0,684A	136,3W	32lm/W

Power FC
0,89



## ISO CANDELA DIAGRAM

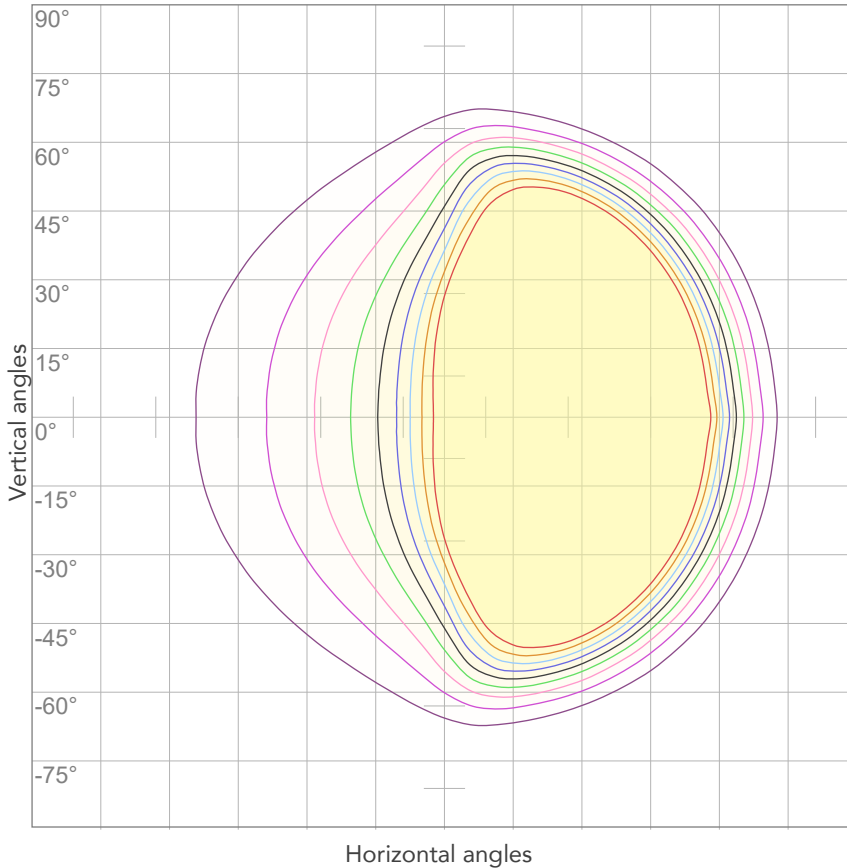

10%	122 cd
20%	244 cd
30%	366 cd
40%	489 cd
50%	611 cd
60%	733 cd
70%	855 cd
80%	977 cd

Conditions:

Number of c-planes: 64

Candela at center: 1221 cd

## ISO LUX DIAGRAM

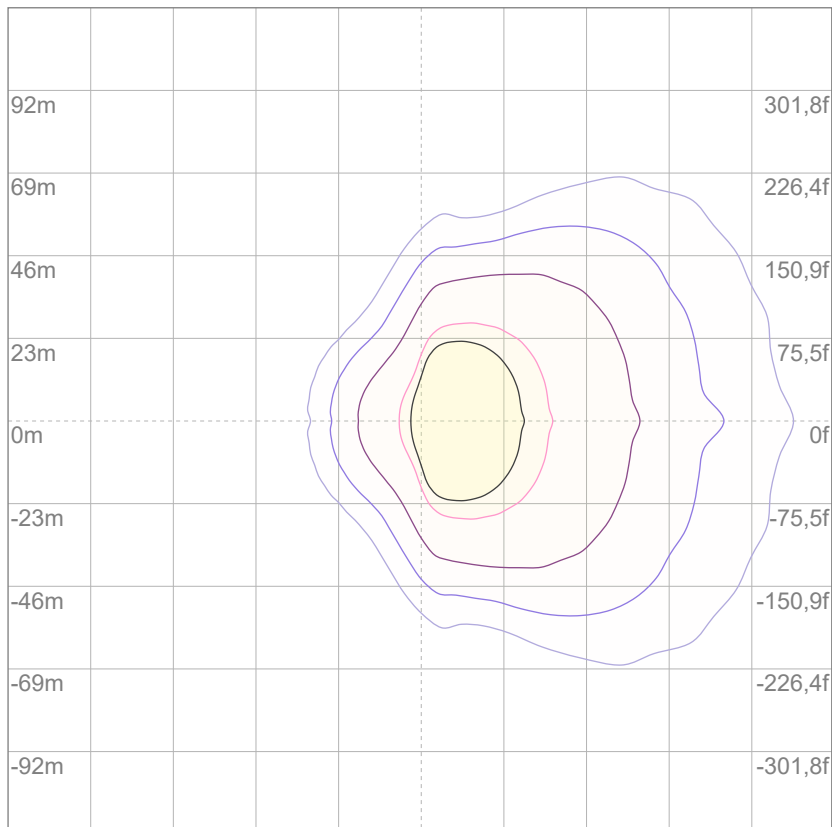

3%	0,366 lx
5%	0,611 lx
10%	1,22 lx
30%	3,66 lx
50%	6,11 lx

Conditions:

Number of c-planes: 64

Lux at center: 12,2 lx

*Lux distribution on a surface when lamp is mounted at 10 meters from the surface.*

Total lumen output:

7857 lm

Peak candela output:

4403 cd



**PRODUCT NAME:**

ECLEXPFL300 FC

**MEASUREMENT CONDITIONS:**

Beam angle:

Asymmetric

Target:

Green

Operator:

Salvatore Giglio

Date and time:

29/03/2023 17:24:01

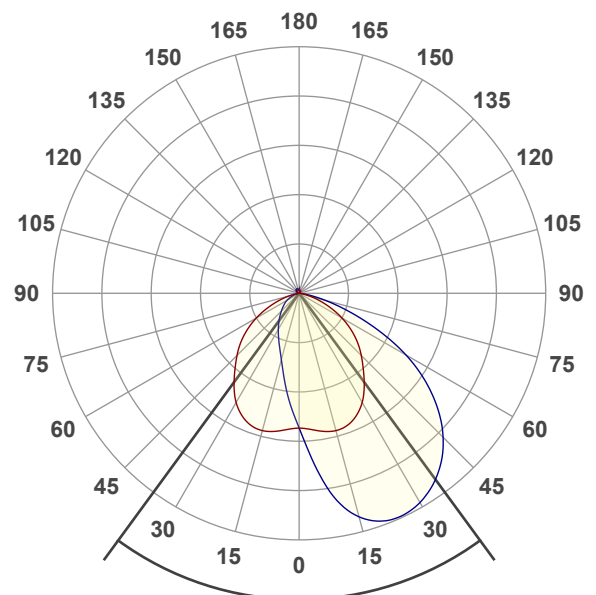

Beam angle 50%: 72,4°

Field angle 10%: 129,2°

Cut off angle 2.5%: 153,9°

Spectra

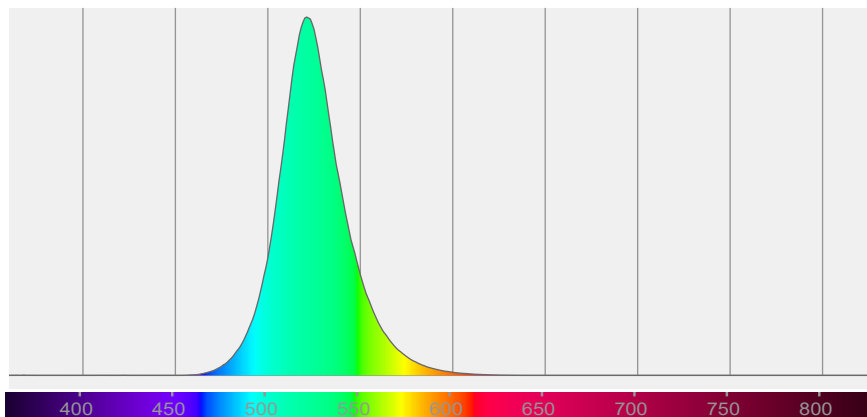

# BEAM DETAILS



Beam angle 50%	Field angle 10%	Cut off angle 2,5%	Intensity ratio in 120° cone	Intensity ratio in 90° cone
72,4°	129,2°	153,9°	82,0%	54,6%

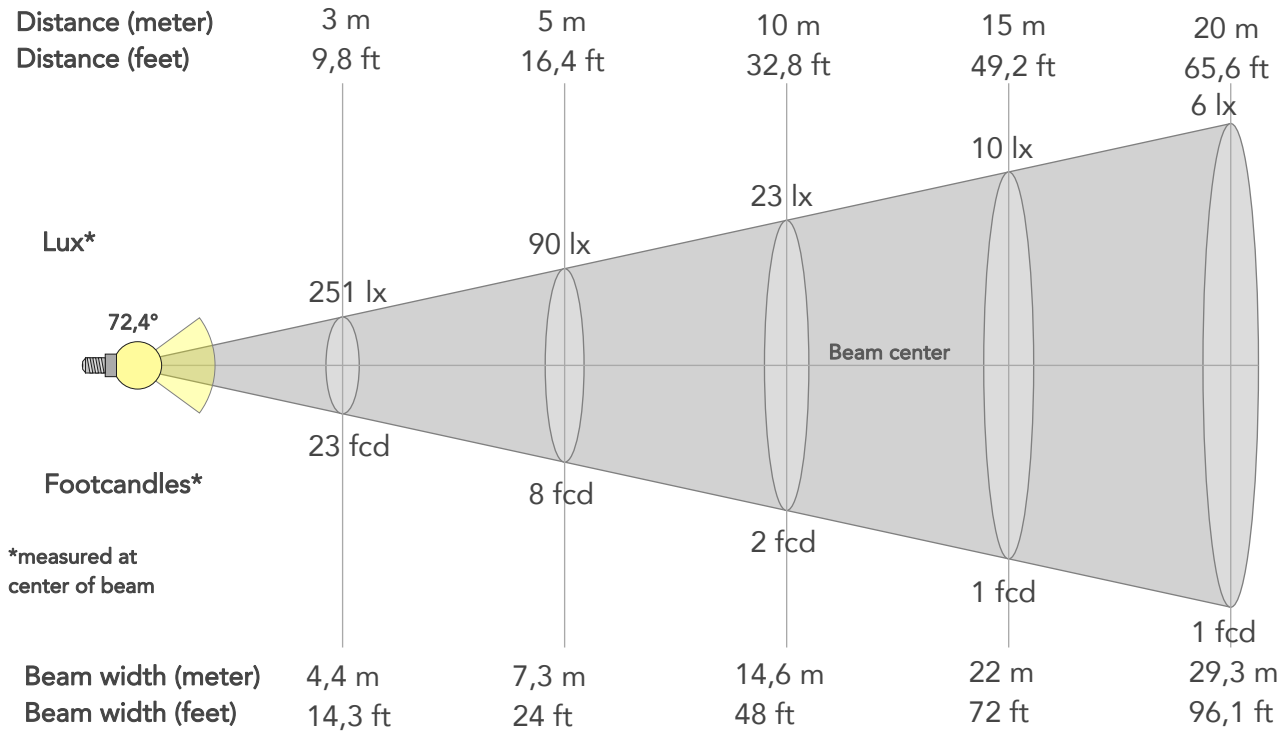

## BEAM INTENSITIES AND WIDTHS

Distance	1m	2m	3m	4m	5m	7,5m	10m	15m	20m	25m	30m	40m	50m
Distance	3,3ft	6,6ft	9,8ft	13,1ft	16,4ft	24,6ft	32,8ft	49,2ft	65,6ft	82ft	98,4ft	131,2ft	164ft
Lux	2262lx	566lx	251lx	141lx	90lx	40lx	23lx	10lx	6lx	4lx	3lx	1lx	1lx
Footcand.	210fcd	53fcd	23fcd	13fcd	8fcd	4fcd	2fcd	1fcd	1fcd	0fcd	0fcd	0fcd	0fcd
Beam wid.	1,5m	2,9m	4,4m	5,9m	7,3m	11m	14,6m	22m	29,3m	36,6m	43,9m	58,6m	73,2m
Beam wid.	4,8ft	9,7ft	14,3ft	19,2ft	24ft	36ft	48ft	72ft	96,1ft	120,1ft	144,1ft	192,1ft	240,1ft

## LINEAR DISTRIBUTION DIAGRAM

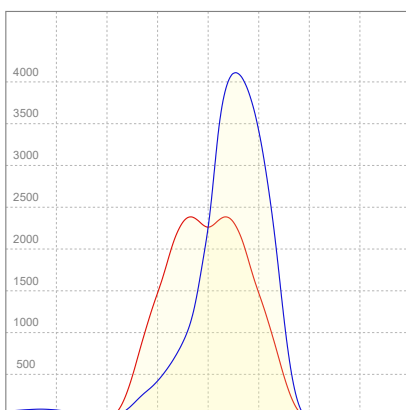

## ELECTRICAL SPECIFICATIONS

Input voltage	Input current	Input power	Effeciency
226V	0,759A	154,9W	51lm/W

Power FC
0,9

## ISO CANDELA DIAGRAM

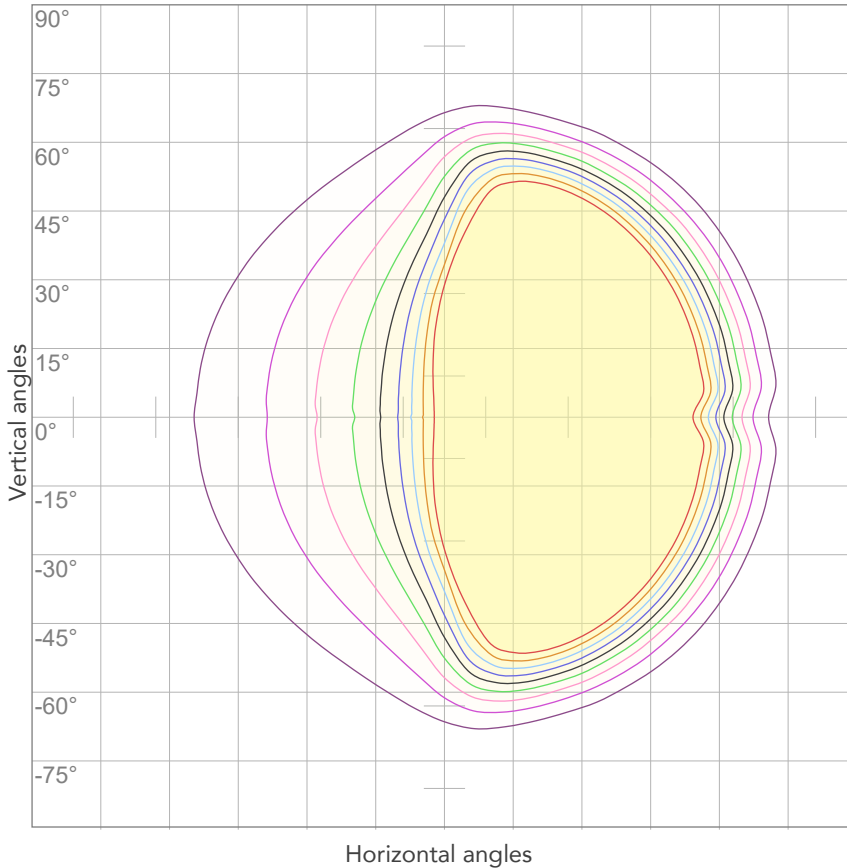

10%	226 cd
20%	452 cd
30%	679 cd
40%	905 cd
50%	1131 cd
60%	1357 cd
70%	1584 cd
80%	1810 cd

Conditions:

Number of c-planes: 64

Candela at center: 2262 cd

## ISO LUX DIAGRAM

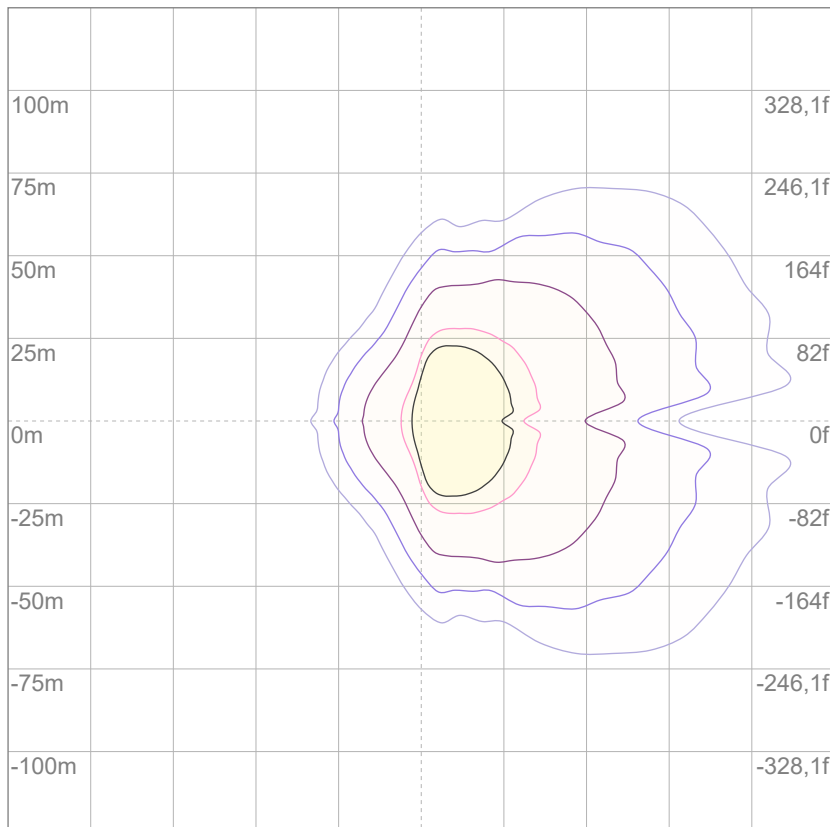

Mounting height: 10 meters (33 feet)

3%	0,679 lx
5%	1,13 lx
10%	2,26 lx
30%	6,79 lx
50%	11,3 lx

Conditions:

Number of c-planes: 64

Lux at center: 22,6 lx

*Lux distribution on a surface when lamp is mounted at 10 meters from the surface.*

Total lumen output:

1840 lm

Peak candela output:

1033 cd



**PRODUCT NAME:**

ECLEXPFL300 FC

**MEASUREMENT CONDITIONS:**

Beam angle:

Asymmetric

Target:

Blue

Operator:

Salvatore Giglio

Date and time:

30/03/2023 13:39:35

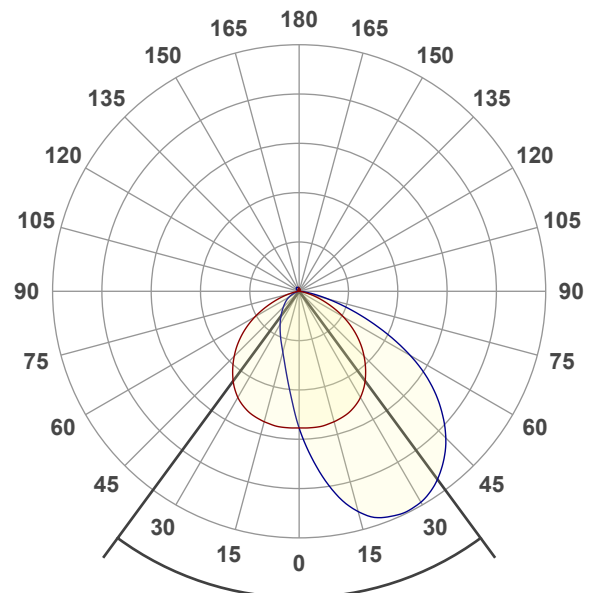

Beam angle 50%: 72,7°

Field angle 10%: 127,7°

Cut off angle 2.5%: 153,1°

Spectra

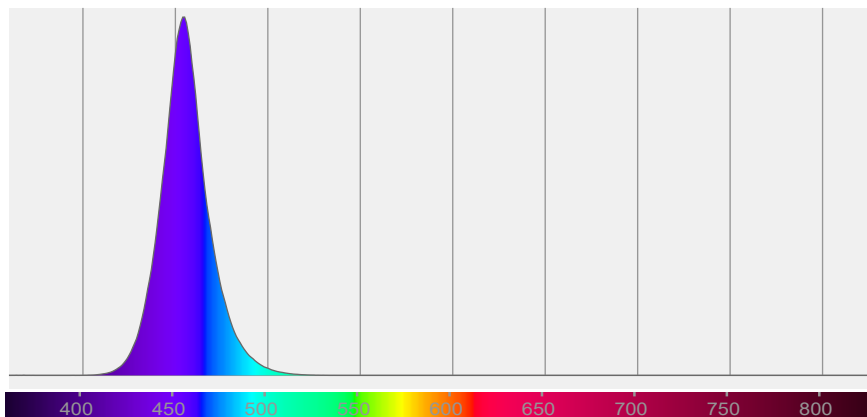

# BEAM DETAILS



Beam angle 50%	Field angle 10%	Cut off angle 2,5%	Intensity ratio in 120° cone	Intensity ratio in 90° cone
72,7°	127,7°	153,1°	82,1%	54,4%

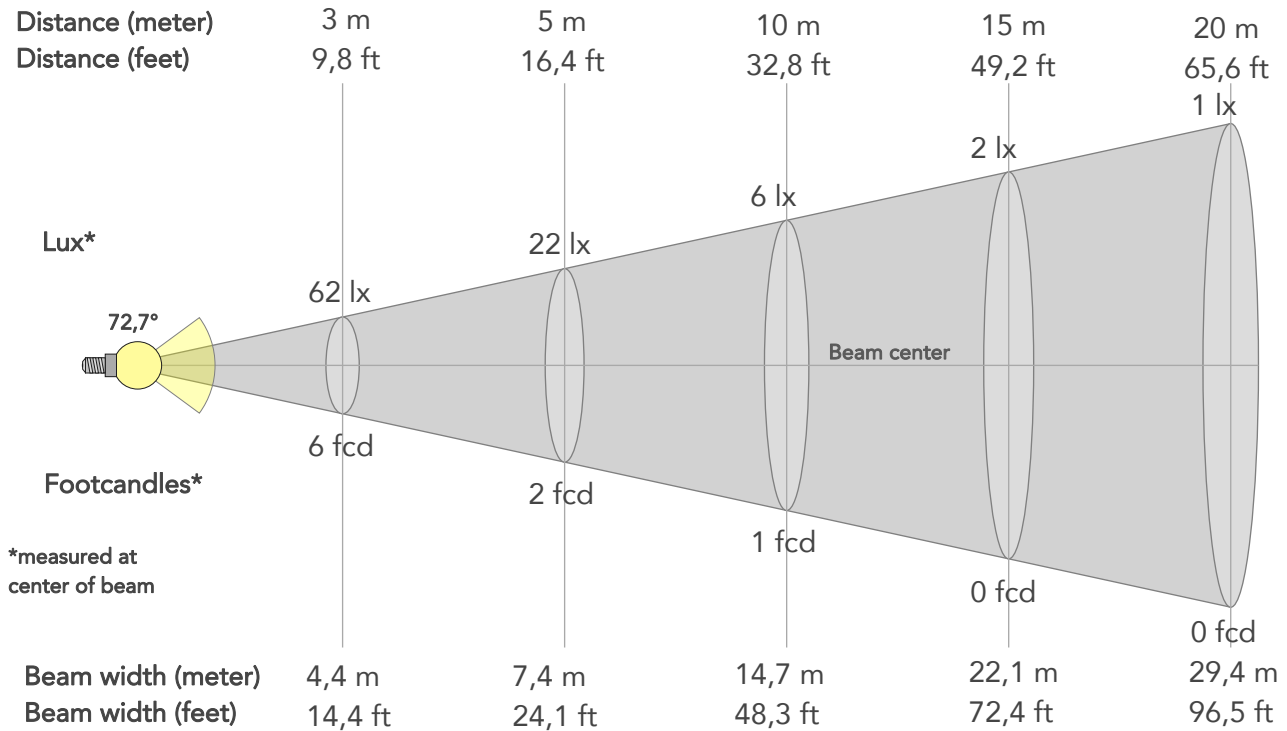

## BEAM INTENSITIES AND WIDTHS

Distance	1m	2m	3m	4m	5m	7,5m	10m	15m	20m	25m	30m	40m	50m
Distance	3,3ft	6,6ft	9,8ft	13,1ft	16,4ft	24,6ft	32,8ft	49,2ft	65,6ft	82ft	98,4ft	131,2ft	164ft
Lux	554lx	138lx	62lx	35lx	22lx	10lx	6lx	2lx	1lx	1lx	1lx	0lx	0lx
Footcand.	51fcd	13fcd	6fcd	3fcd	2fcd	1fcd	1fcd	0fcd	0fcd	0fcd	0fcd	0fcd	0fcd
Beam wid.	1,5m	2,9m	4,4m	5,9m	7,4m	11m	14,7m	22,1m	29,4m	36,8m	44,1m	58,8m	73,6m
Beam wid.	4,9ft	9,7ft	14,4ft	19,3ft	24,1ft	36,2ft	48,3ft	72,4ft	96,5ft	120,6ft	144,8ft	193ft	241,3ft

## LINEAR DISTRIBUTION DIAGRAM

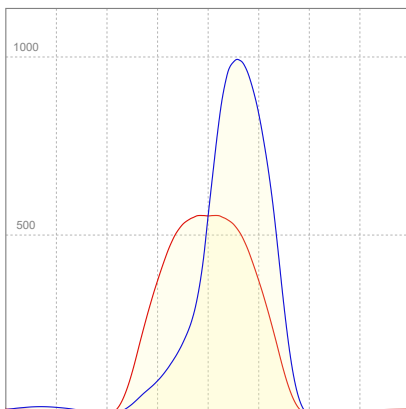

## ELECTRICAL SPECIFICATIONS

Input voltage	Input current	Input power	Effeciency
226V	0,793A	162,7W	11lm/W

Power FC
0,91

## ISO CANDELA DIAGRAM

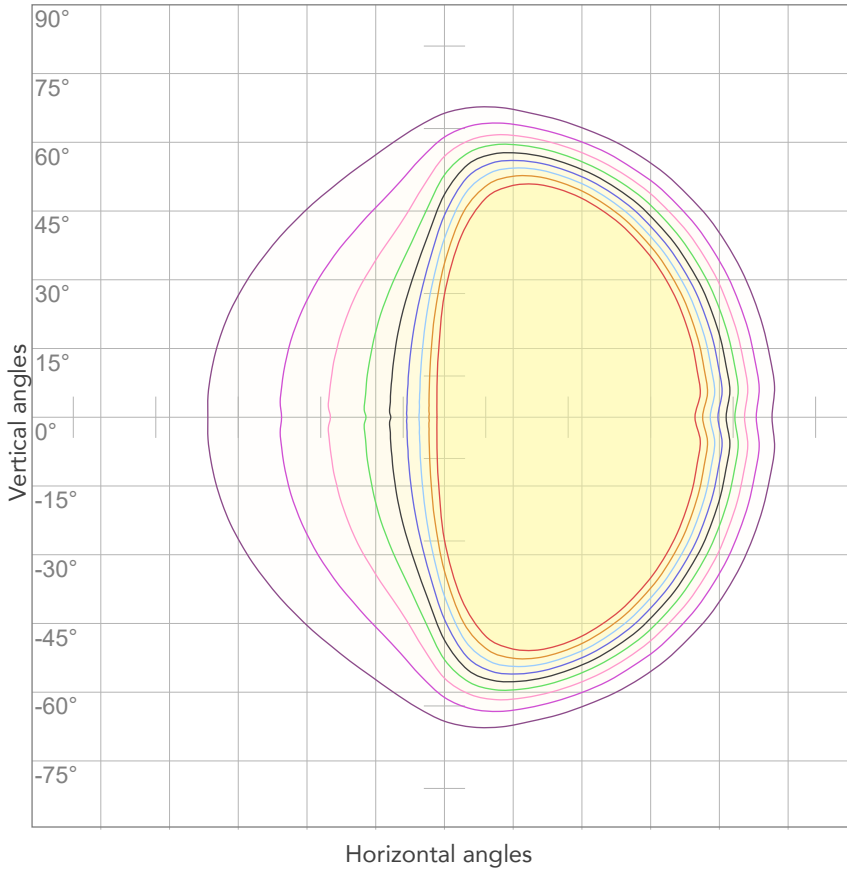

10%	55 cd
20%	111 cd
30%	166 cd
40%	222 cd
50%	277 cd
60%	332 cd
70%	388 cd
80%	443 cd

Conditions:

Number of c-planes: 68

Candela at center: 554 cd

## ISO LUX DIAGRAM

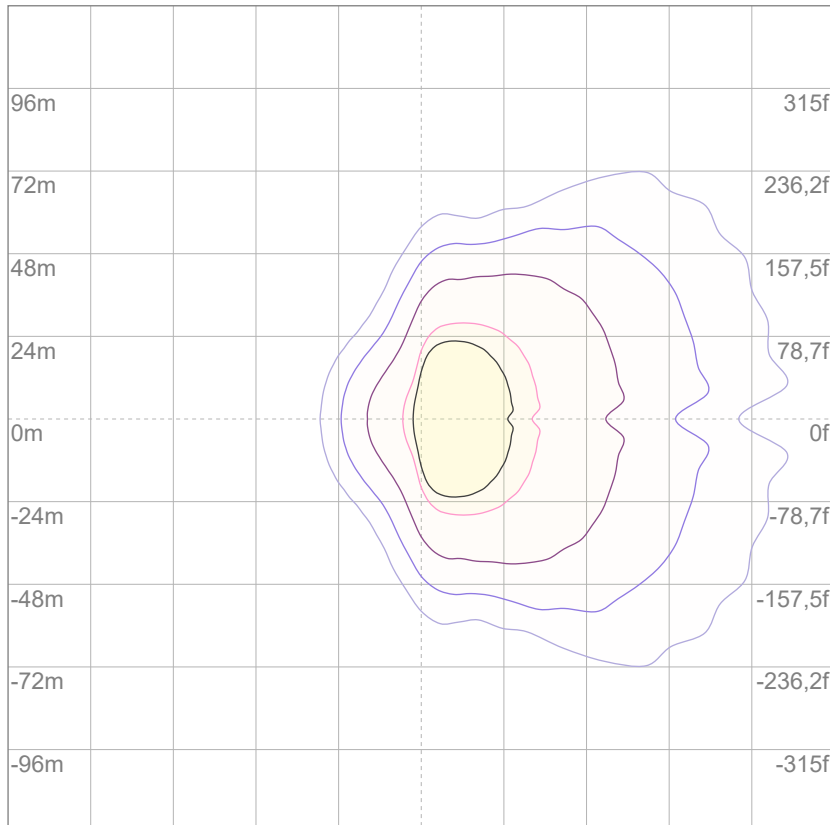

3%	0,166 lx
5%	0,277 lx
10%	0,554 lx
30%	1,66 lx
50%	2,77 lx

Conditions:

Number of c-planes: 68

Lux at center: 5,54 lx

*Lux distribution on a surface when lamp is mounted at 10 meters from the surface.*

Total lumen output:

7656 lm

Peak candela output:

4500 cd



**PRODUCT NAME:**

ECLEXPFL300 FC

**MEASUREMENT CONDITIONS:**

Beam angle:

Asymmetric

Target:

White

Operator:

Salvatore Giglio

Date and time:

30/03/2023 13:08:13

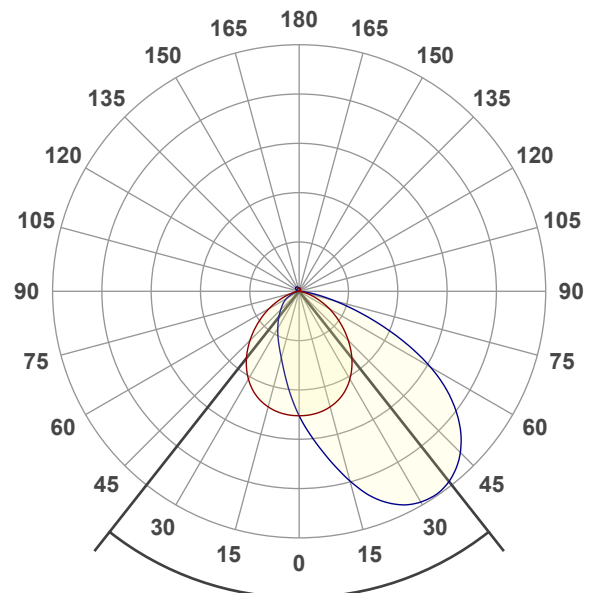

Beam angle 50%: 76,5°

Field angle 10%: 132,5°

Cut off angle 2.5%: 198,4°

Spectra

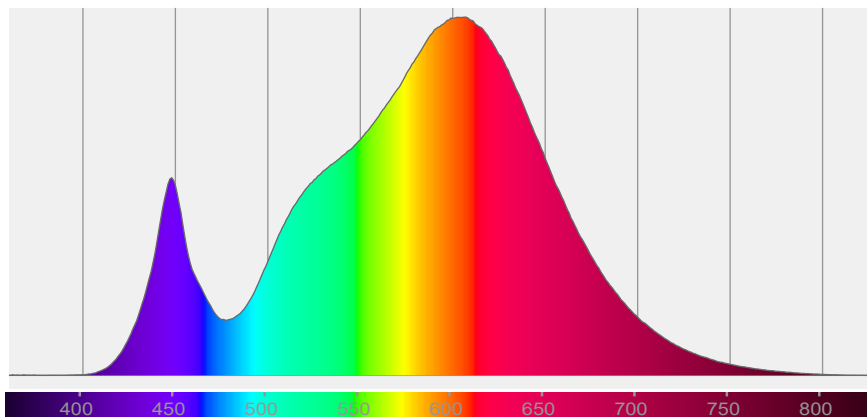



# BEAM DETAILS



Beam angle 50%	Field angle 10%	Cut off angle 2,5%	Intensity ratio in 120° cone	Intensity ratio in 90° cone
76,5°	132,5°	198,4°	80,5%	52,4%

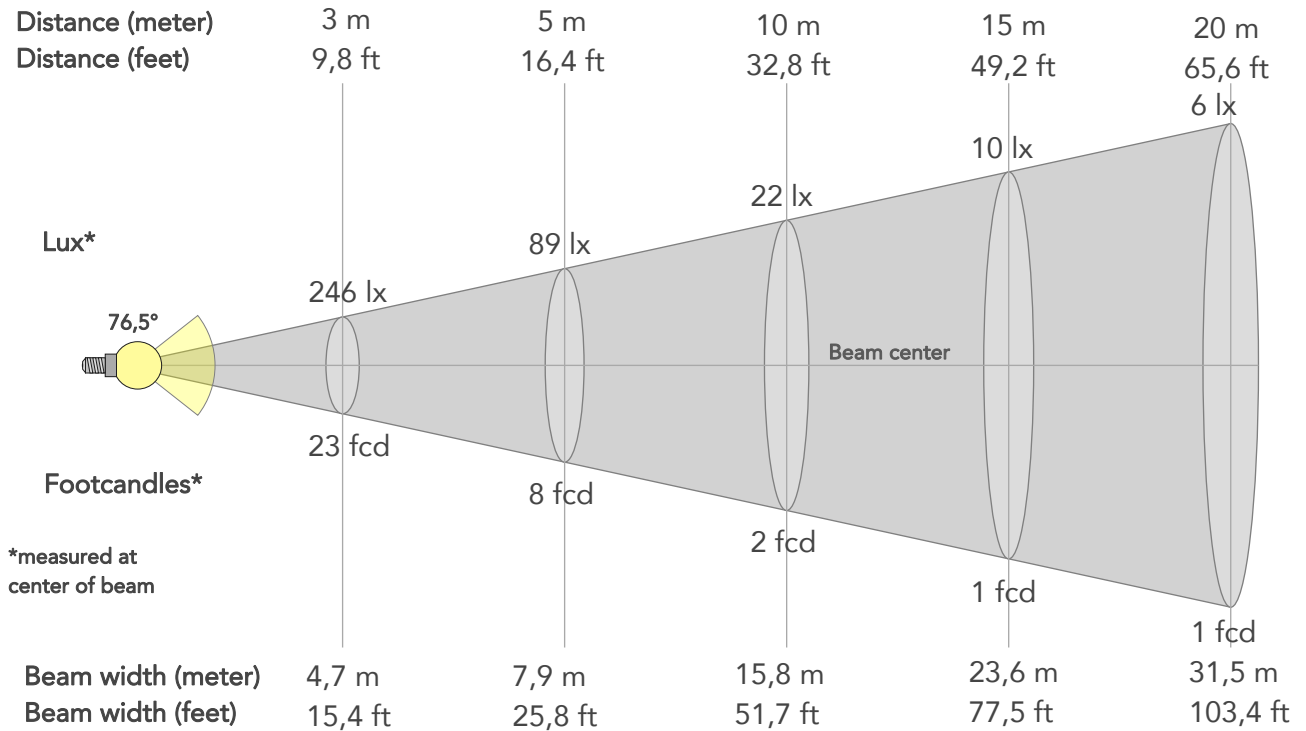

## BEAM INTENSITIES AND WIDTHS

Distance	1m	2m	3m	4m	5m	7,5m	10m	15m	20m	25m	30m	40m	50m
Distance	3,3ft	6,6ft	9,8ft	13,1ft	16,4ft	24,6ft	32,8ft	49,2ft	65,6ft	82ft	98,4ft	131,2ft	164ft
Lux	2216lx	554lx	246lx	139lx	89lx	39lx	22lx	10lx	6lx	4lx	2lx	1lx	1lx
Footcand.	206fcd	51fcd	23fcd	13fcd	8fcd	4fcd	2fcd	1fcd	1fcd	0fcd	0fcd	0fcd	0fcd
Beam wid.	1,6m	3,2m	4,7m	6,3m	7,9m	11,8m	15,8m	23,6m	31,5m	39,4m	47,3m	63m	78,8m
Beam wid.	5,2ft	10,4ft	15,4ft	20,6ft	25,8ft	38,8ft	51,7ft	77,5ft	103,4ft	129,2ft	155,1ft	206,7ft	258,4ft

## LINEAR DISTRIBUTION DIAGRAM

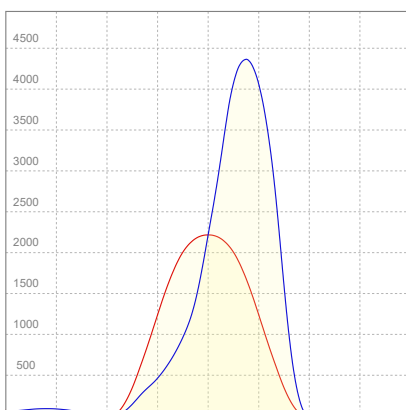

## ELECTRICAL SPECIFICATIONS

Input voltage	Input current	Input power	Effeciency
225V	0,750A	152,5W	50lm/W

Power FC
0,9

## ISO CANDELA DIAGRAM

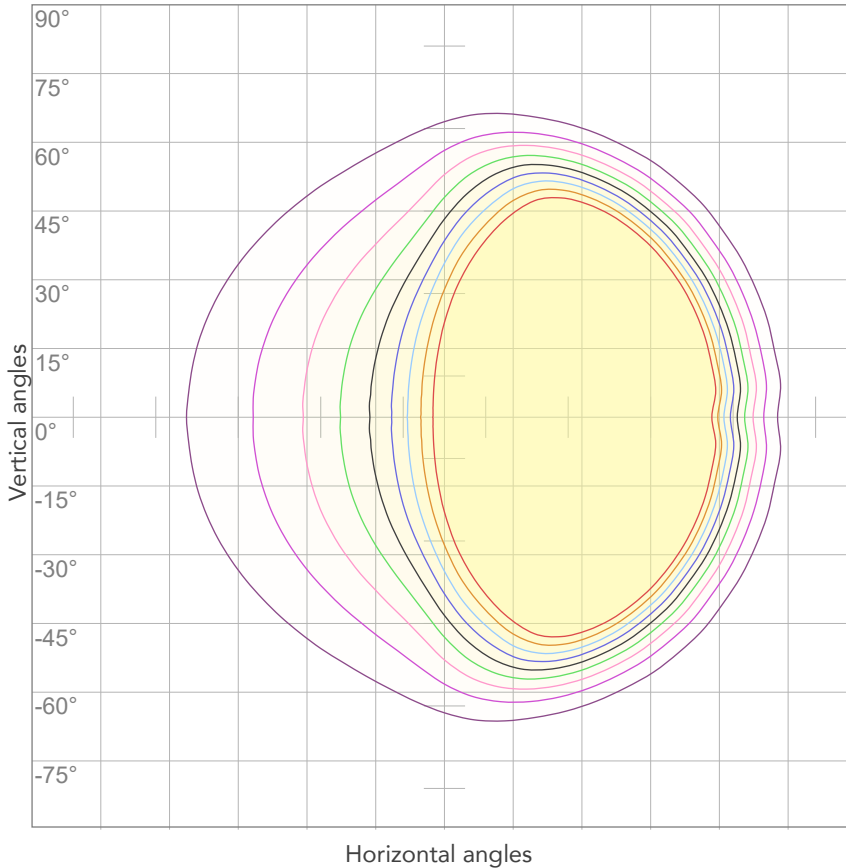

10%	222 cd
20%	443 cd
30%	665 cd
40%	886 cd
50%	1108 cd
60%	1330 cd
70%	1551 cd
80%	1773 cd

**Conditions:**

Number of c-planes: 64

Candela at center: 2216 cd

## ISO LUX DIAGRAM

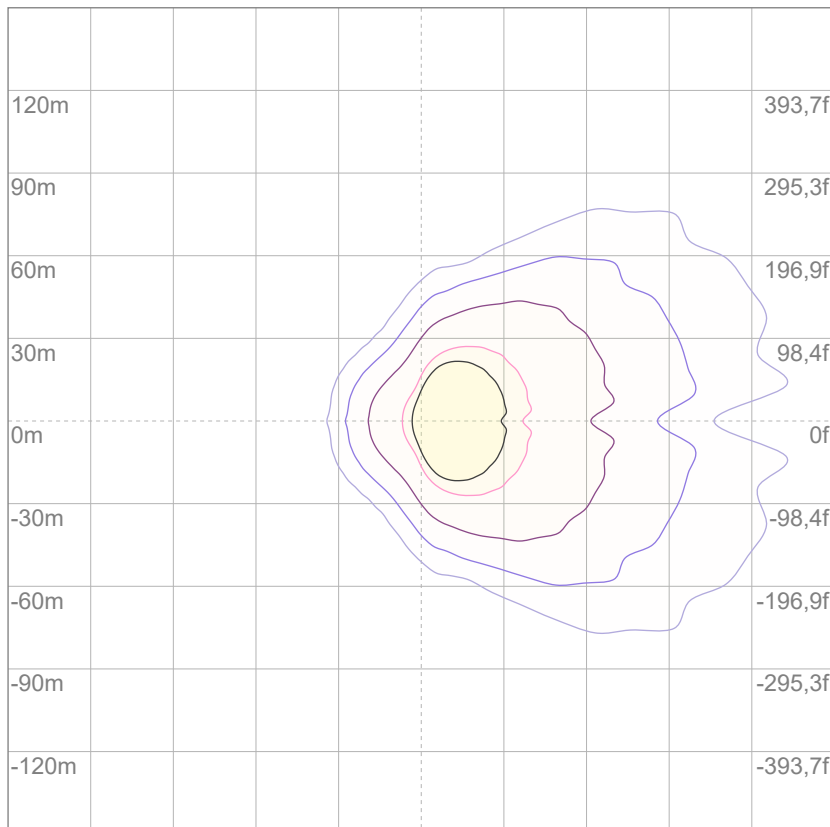

3%	0,665 lx
5%	1,11 lx
10%	2,22 lx
30%	6,65 lx
50%	11,1 lx

**Conditions:**

Number of c-planes: 64

Lux at center: 22,2 lx

*Lux distribution on a surface when lamp is mounted at 10 meters from the surface.*



Total lumen output:

10308 lm

Peak candela output:

6009 cd

Light quality:

CRI: 86,4

Color temperature:

2808 K

**PRODUCT NAME:**

ECLEXPOFL300 FC

**MEASUREMENT CONDITIONS:**

Beam angle:

Asymmetric

Target:

2800K

Operator:

Salvatore Giglio

Date and time:

30/03/2023 14:04:06

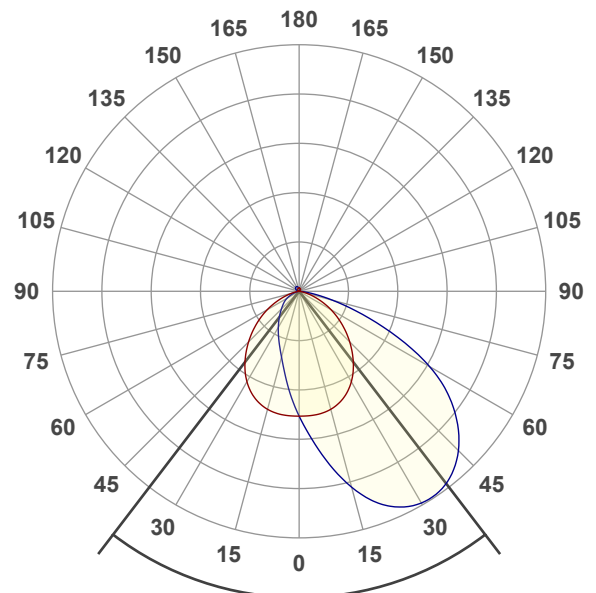

Beam angle 50%: 74,8°

Field angle 10%: 130,7°

Cut off angle 2.5%: 173,2°

Spectra

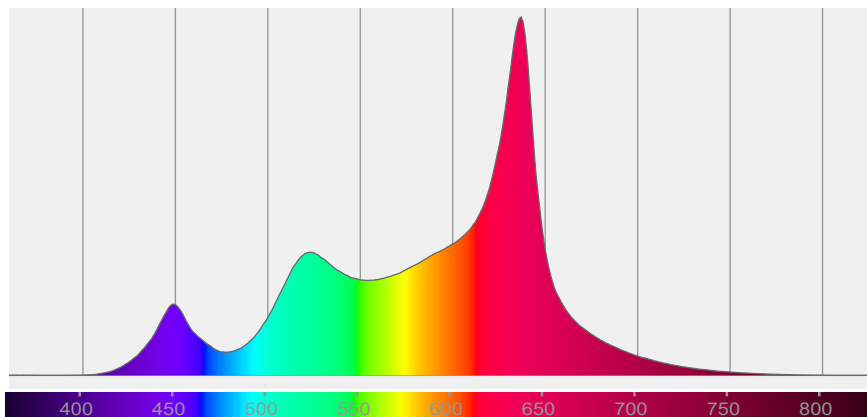

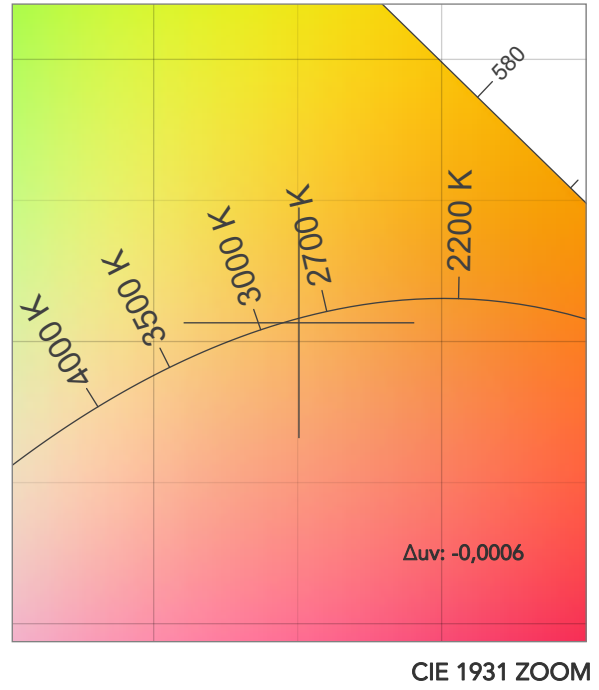
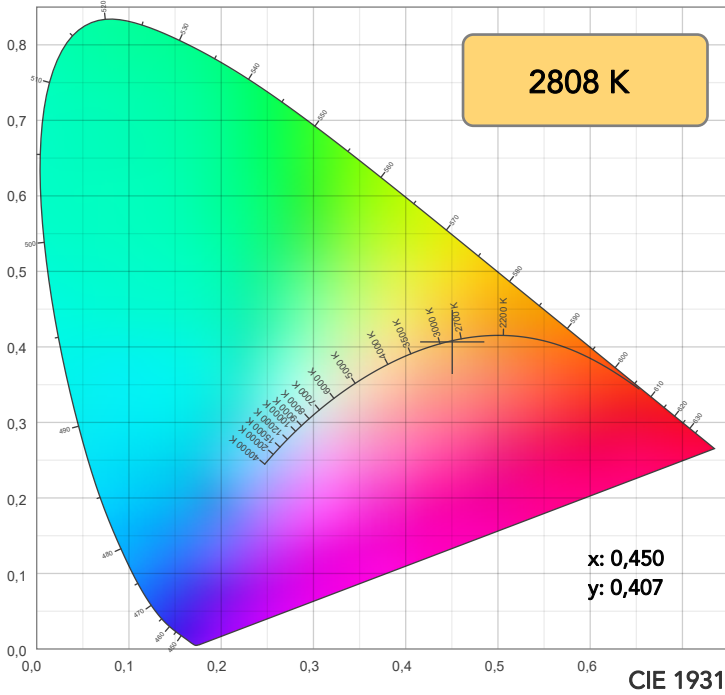

TM30: 89,8

CRI: 86,4 (R1-R8)

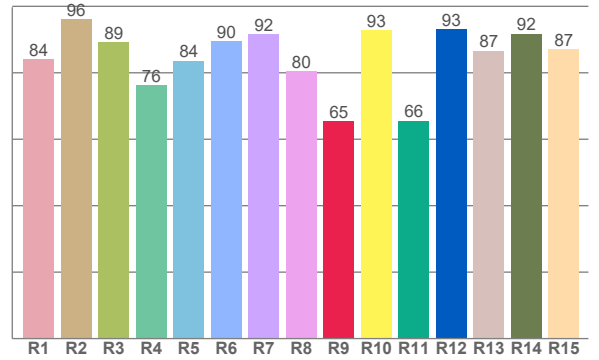
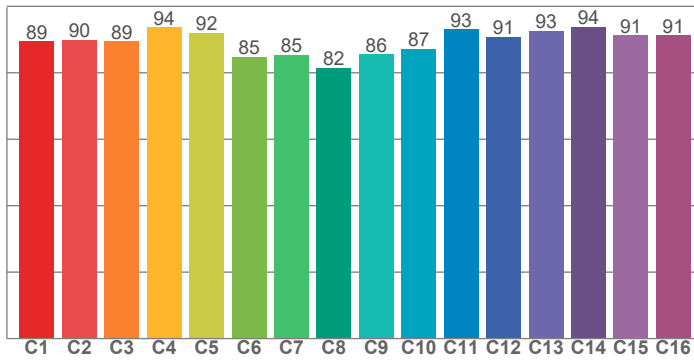

CRI R values, only R1-R8 are used to calculate final CRI value

R1	R2	R3	R4	R5	R6	R7	R8	R9	R10	R11	R12	R13	R14	R15
84,2	96,1	89,2	76,3	83,7	89,5	91,5	80,4	65,4	92,8	65,5	93,1	86,6	91,8	87,1

TM30 C values, 16 binned values out of total of 99 C values

C1	C2	C3	C4	C5	C6	C7	C8	C9	C10	C11	C12	C13	C14	C15	C16
89,4	89,9	89,5	93,6	92,0	84,8	85,4	81,5	85,5	87,1	93,0	90,8	92,6	93,8	91,2	91,3

CQS Q values

Q1	Q2	Q3	Q4	Q5	Q6	Q7	Q8	Q9	Q10	Q11	Q12	Q13	Q14	Q15
96,5	95,8	96,6	85,4	80,5	79,3	91,9	92,9	94,0	96,5	88,3	86,3	87,5	93,7	95,1

CQS: 88,8

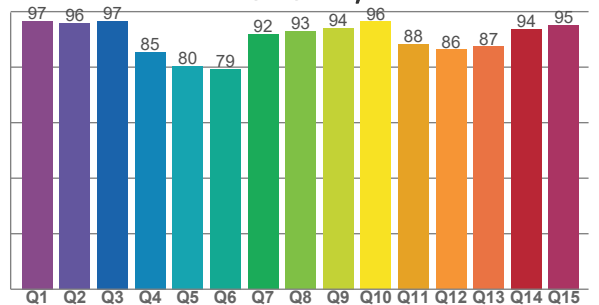

COLOR PARAMETERS

Color temperature	Color rendering index	Red component	Color fidelity	Color gamut	Color quality scale	Television lighting index	Color coordinate cie 1931	Color coordinate cie 1931	Color deviation from black body
CCT	CRI	CRI R9	TM30 Rf	TM30 Rg	CQS	TLCI	x	y	Δuv
2808 K	86,4	65,4	89,8	108,6	88,8	77	0,450	0,407	-0,0006

# TM30 DETAILS

**Rf 89,8**  
Fidelity index Rf

**Rg 108,6**  
Gammut index

Hue Bin	R <sub>f</sub>	Graphic shifts (%)	
		Chroma	Hue
1	89	4%	-2%
2	90	4%	-3%
3	89	3%	-3%
4	94	2%	-1%
5	92	4%	5%
6	85	9%	6%
7	85	9%	0%
8	82	11%	-5%
9	86	6%	-7%
10	87	2%	-8%
11	93	0%	-5%
12	91	3%	-4%
13	93	3%	-5%
14	94	3%	0%
15	91	4%	0%
16	91	6%	-3%

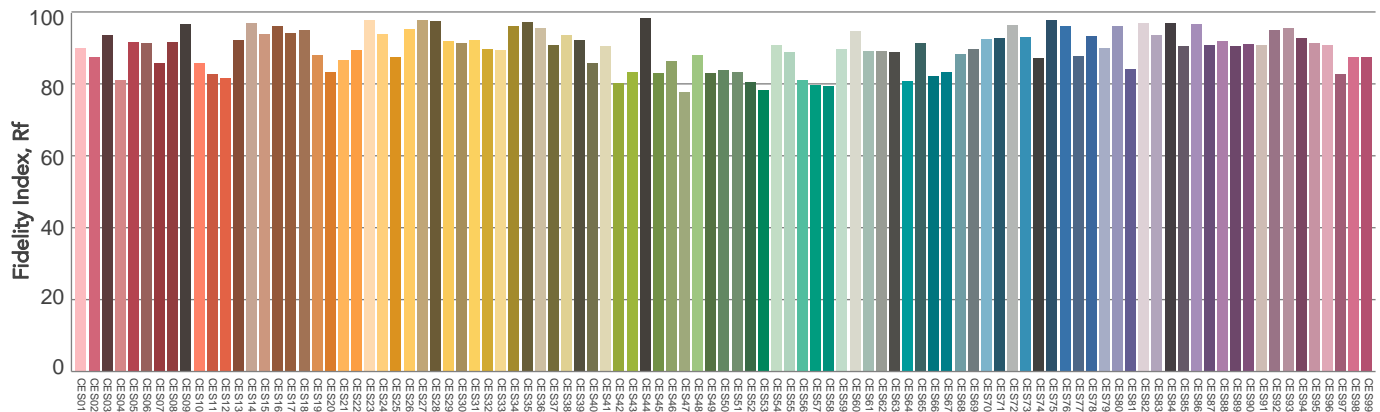
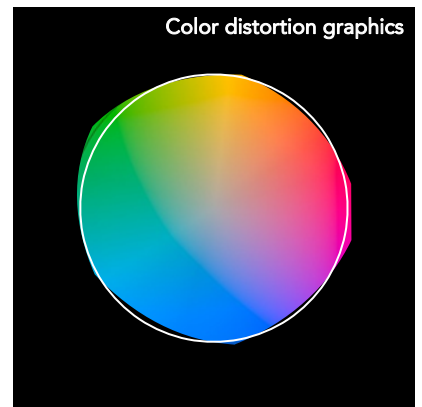
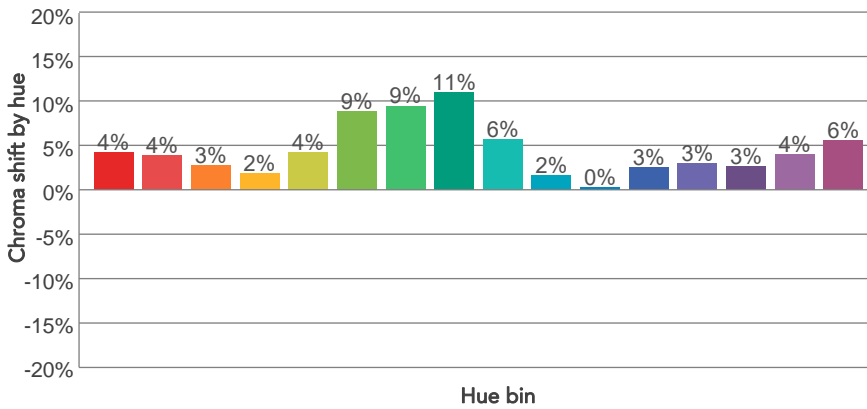
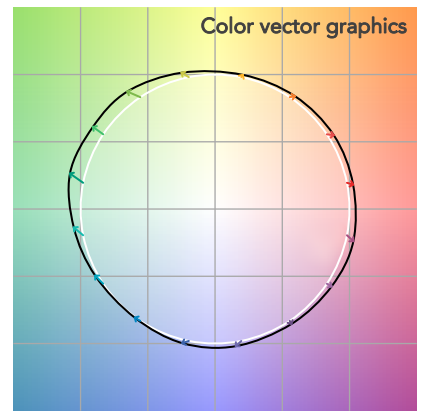
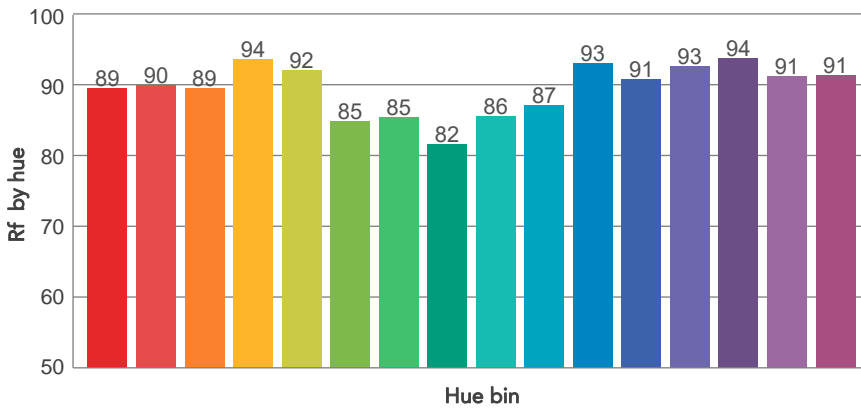
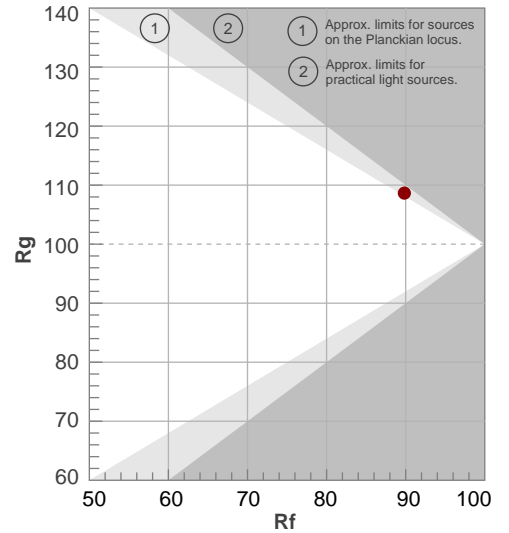

# BEAM DETAILS



Beam angle 50%	Field angle 10%	Cut off angle 2,5%	Intensity ratio in 120° cone	Intensity ratio in 90° cone
74,8°	130,7°	173,2°	81,2%	53,1%

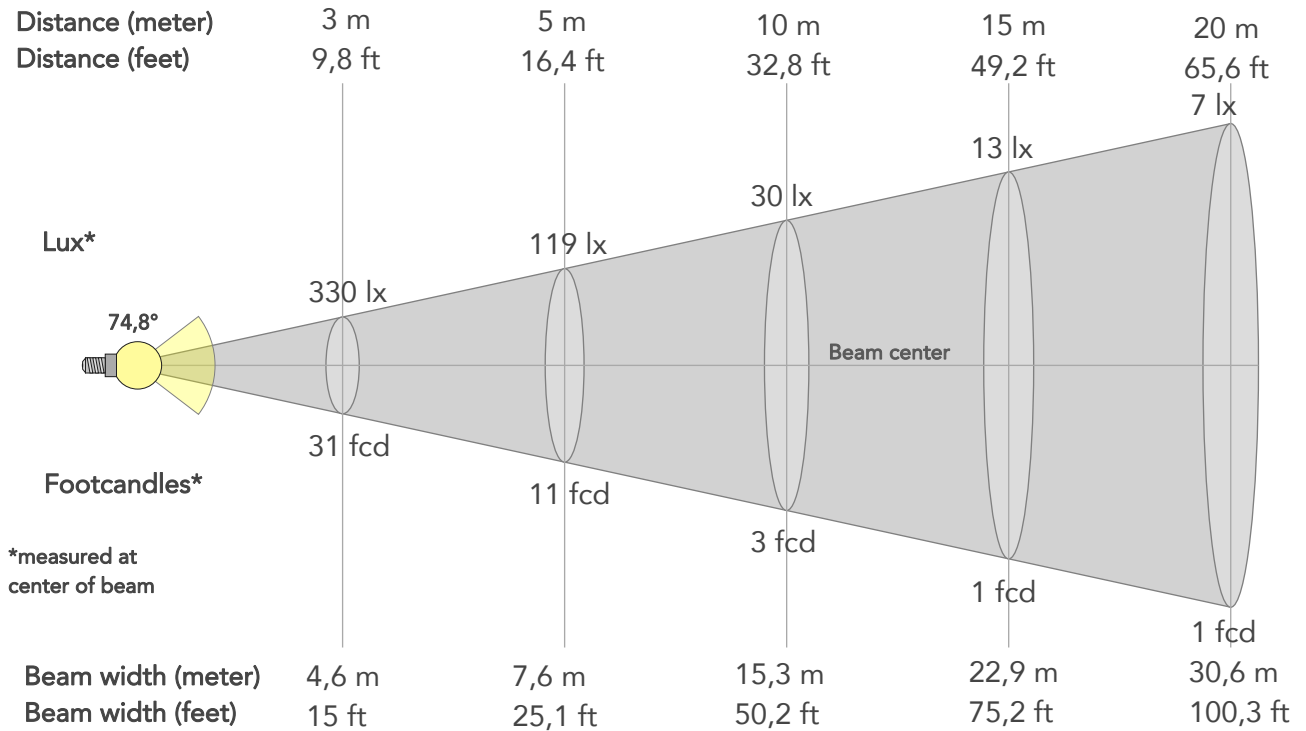

## BEAM INTENSITIES AND WIDTHS

Distance	1m	2m	3m	4m	5m	7,5m	10m	15m	20m	25m	30m	40m	50m
Distance	3,3ft	6,6ft	9,8ft	13,1ft	16,4ft	24,6ft	32,8ft	49,2ft	65,6ft	82ft	98,4ft	131,2ft	164ft
Lux	2968lx	742lx	330lx	185lx	119lx	53lx	30lx	13lx	7lx	5lx	3lx	2lx	1lx
Footcand.	276fcd	69fcd	31fcd	17fcd	11fcd	5fcd	3fcd	1fcd	1fcd	0fcd	0fcd	0fcd	0fcd
Beam wid.	1,5m	3,1m	4,6m	6,1m	7,6m	11,5m	15,3m	22,9m	30,6m	38,2m	45,9m	61,2m	76,5m
Beam wid.	5ft	10,1ft	15ft	20ft	25,1ft	37,6ft	50,2ft	75,2ft	100,3ft	125,4ft	150,5ft	200,7ft	250,8ft

## LINEAR DISTRIBUTION DIAGRAM

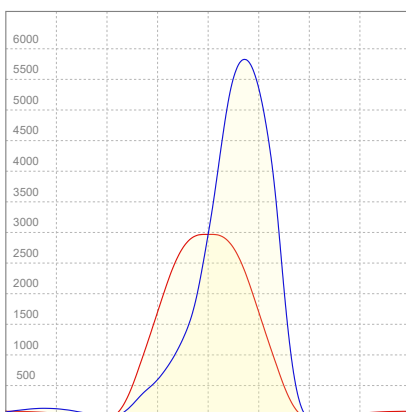

## ELECTRICAL SPECIFICATIONS

Input voltage	Input current	Input power	Effeciency
226V	1,02A	217,4W	47lm/W

## ISO CANDELA DIAGRAM

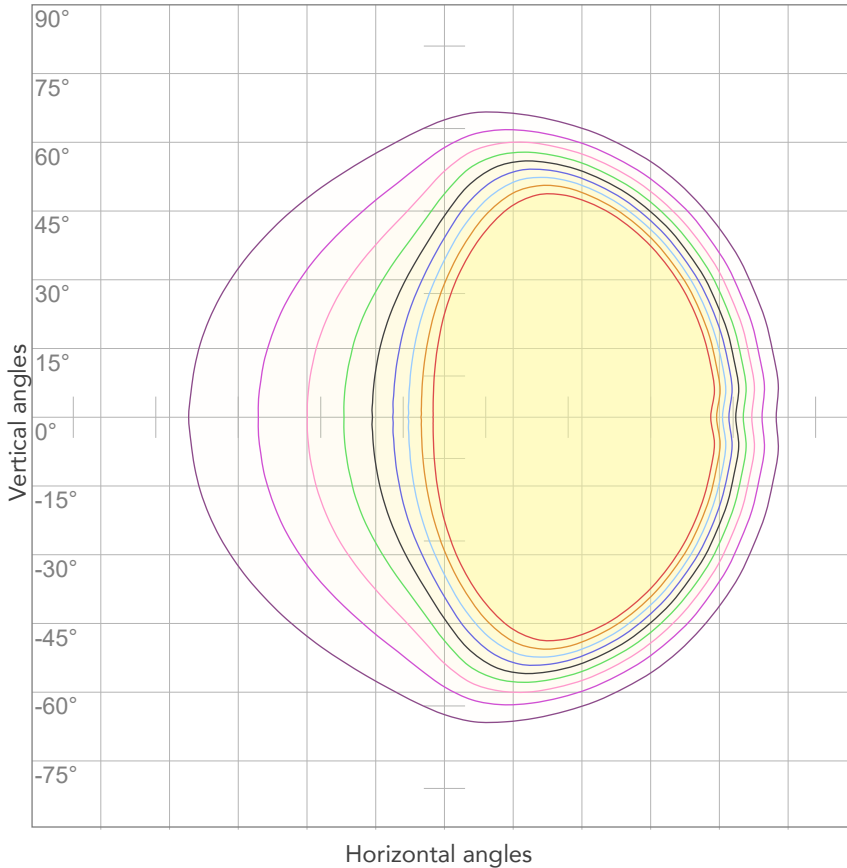

10%	297 cd
20%	594 cd
30%	890 cd
40%	1187 cd
50%	1484 cd
60%	1781 cd
70%	2077 cd
80%	2374 cd

Conditions:

Number of c-planes: 64

Candela at center: 2968 cd

## ISO LUX DIAGRAM

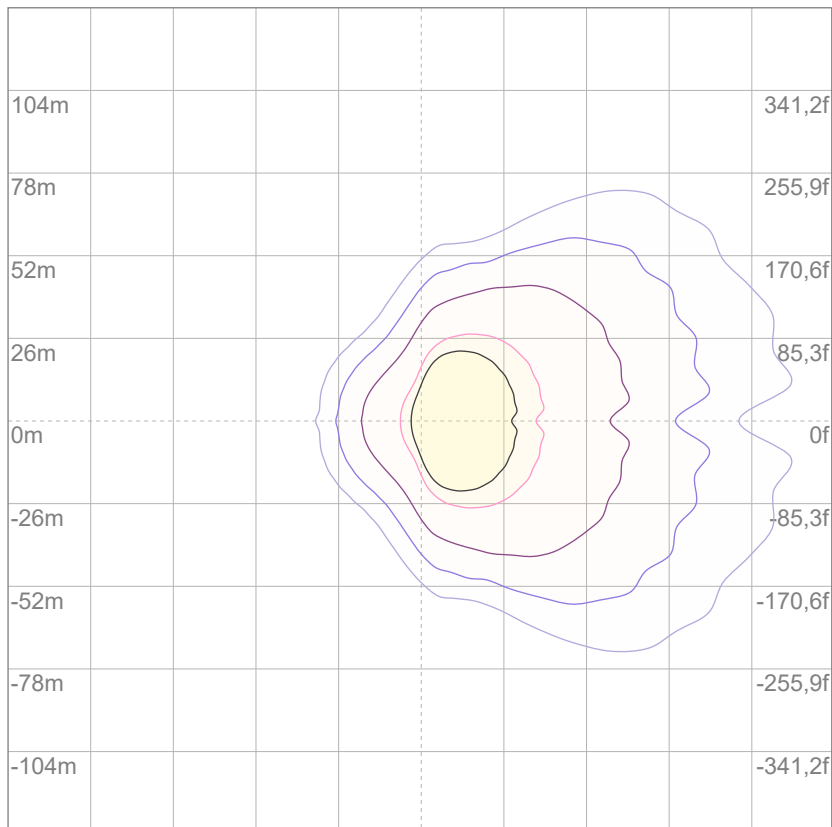

Mounting height: 10 meters (33 feet)

3%	0,890 lx
5%	1,48 lx
10%	2,97 lx
30%	8,90 lx
50%	14,8 lx

Conditions:

Number of c-planes: 64

Lux at center: 29,7 lx

*Lux distribution on a surface when lamp is mounted at 10 meters from the surface.*



Total lumen output:

10197 lm

Peak candela output:

6012 cd

Light quality:

CRI: 90,5

Color temperature:

3199 K

**PRODUCT NAME:**

ECLEXPFL300 FC

**MEASUREMENT CONDITIONS:**

Beam angle:

Asymmetric

Target:

3200K

Operator:

Salvatore Giglio

Date and time:

30/03/2023 14:27:57

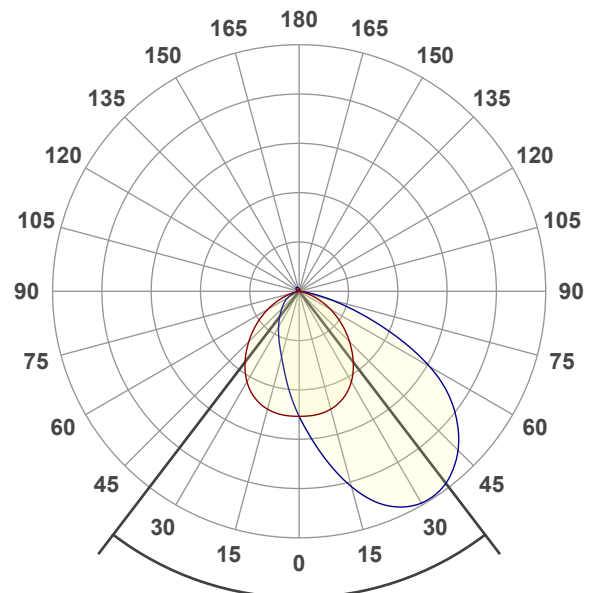

Beam angle 50%: 74,8°

Field angle 10%: 130°

Cut off angle 2.5%: 153,2°

Spectra

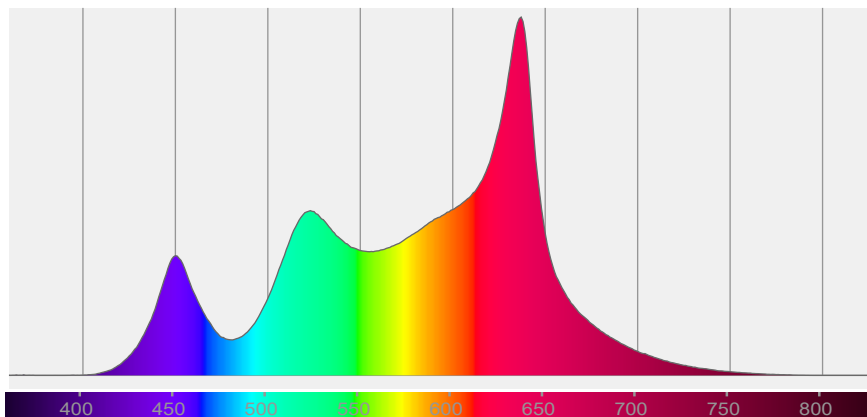



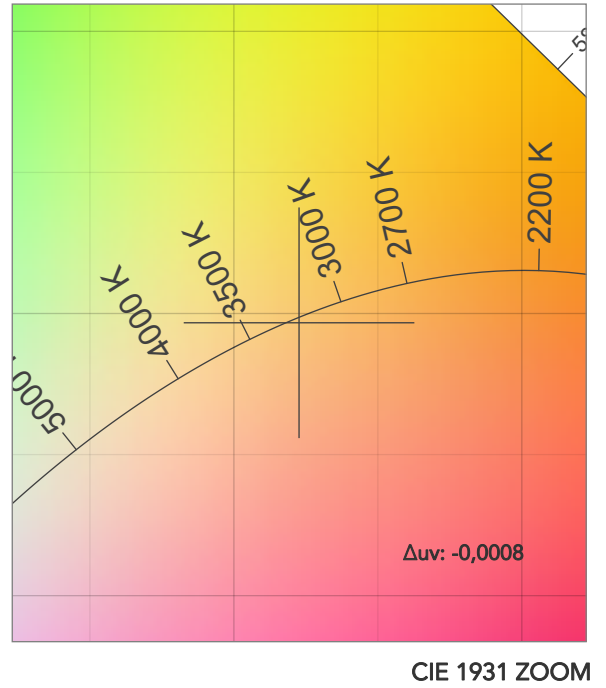
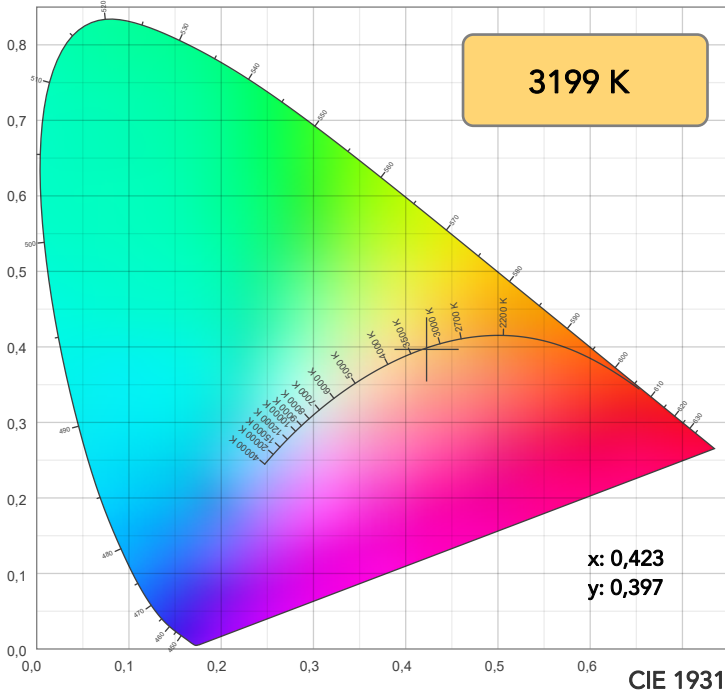

TM30: 92,1

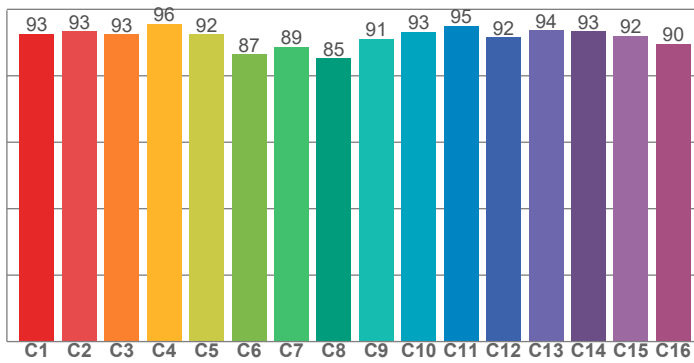

CRI: 90,5 (R1-R8)

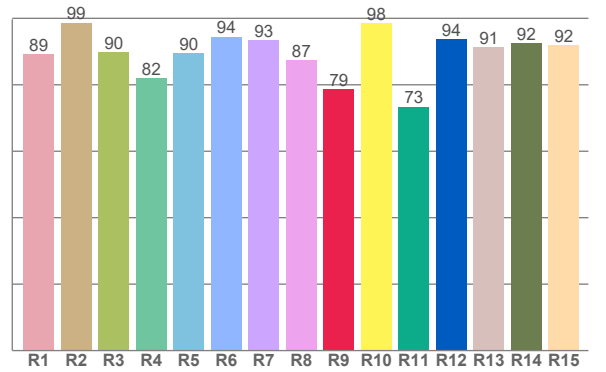

CQS: 92,0

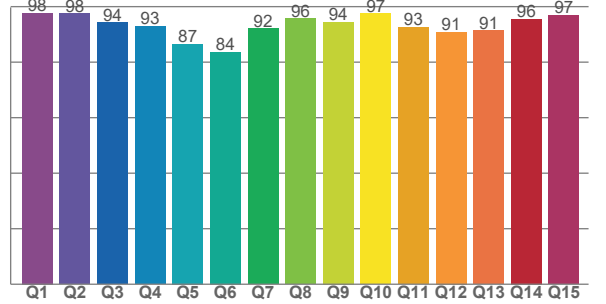

CRI R values, only R1-R8 are used to calculate final CRI value

R1	R2	R3	R4	R5	R6	R7	R8	R9	R10	R11	R12	R13	R14	R15
89,2	98,6	89,7	82,1	89,5	94,5	93,4	87,4	78,7	98,5	73,4	93,7	91,3	92,5	91,9

TM30 C values, 16 binned values out of total of 99 C values

C1	C2	C3	C4	C5	C6	C7	C8	C9	C10	C11	C12	C13	C14	C15	C16
92,6	93,4	92,5	95,6	92,5	86,5	88,8	85,3	91,1	93,2	95,1	91,5	93,7	93,4	92,0	89,6

CQS Q values

Q1	Q2	Q3	Q4	Q5	Q6	Q7	Q8	Q9	Q10	Q11	Q12	Q13	Q14	Q15
97,7	97,6	94,2	92,9	86,6	83,7	92,1	95,7	94,4	97,5	92,6	90,8	91,4	95,6	96,9

COLOR PARAMETERS

Color temperature	Color rendering index	Red component	Color fidelity	Color gamut	Color quality scale	Television lighting index	Color coordinate cie 1931	Color coordinate cie 1931	Color deviation from black body
CCT	CRI	CRI R9	TM30 Rf	TM30 Rg	CQS	TLCI	x	y	Δuv
3199 K	90,5	78,7	92,1	107,4	92,0	84	0,423	0,397	-0,0008

# TM30 DETAILS

**Rf 92,1**  
Fidelity index Rf

**Rg 107,4**  
Gammut index

Hue Bin	R <sub>f</sub>	Graphic shifts (%)	
		Chroma	Hue
1	93	3%	-2%
2	93	2%	-2%
3	93	2%	-1%
4	96	1%	1%
5	92	3%	4%
6	87	8%	5%
7	89	7%	0%
8	85	8%	-4%
9	91	4%	-4%
10	93	0%	-4%
11	95	0%	1%
12	92	4%	-2%
13	94	3%	-3%
14	93	4%	-1%
15	92	4%	-1%
16	90	6%	-6%

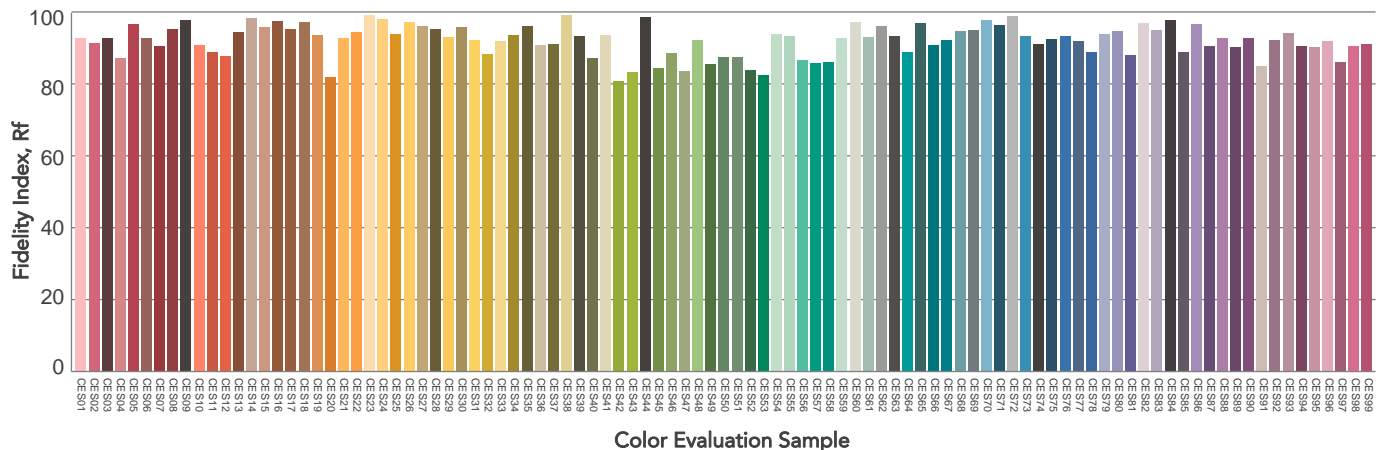
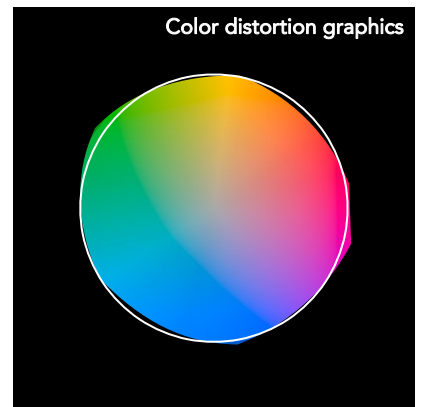
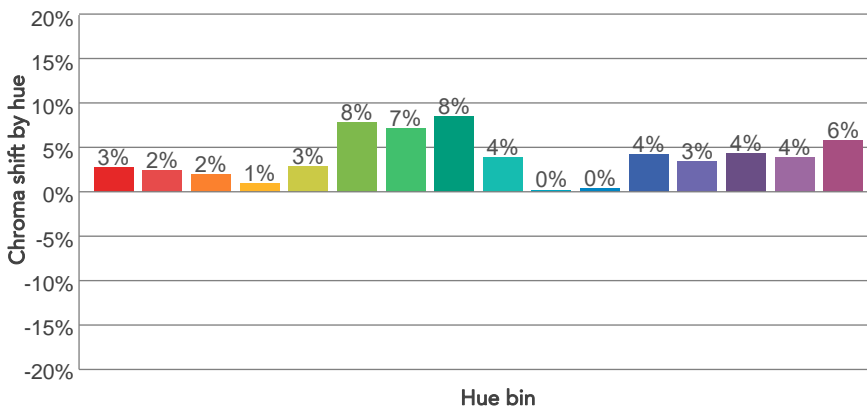
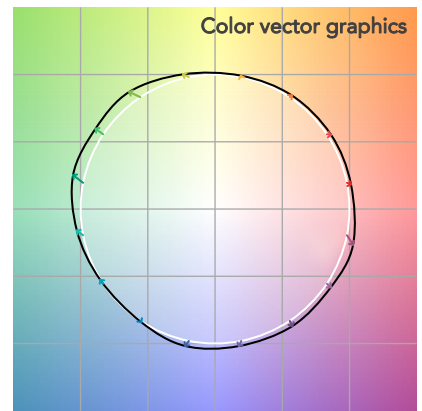
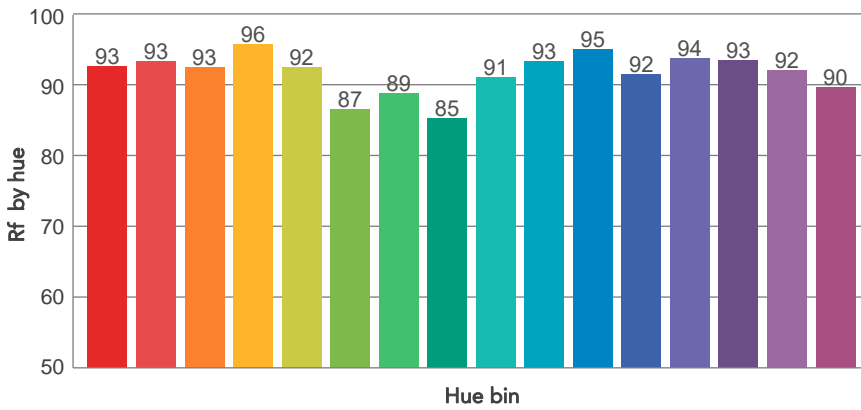
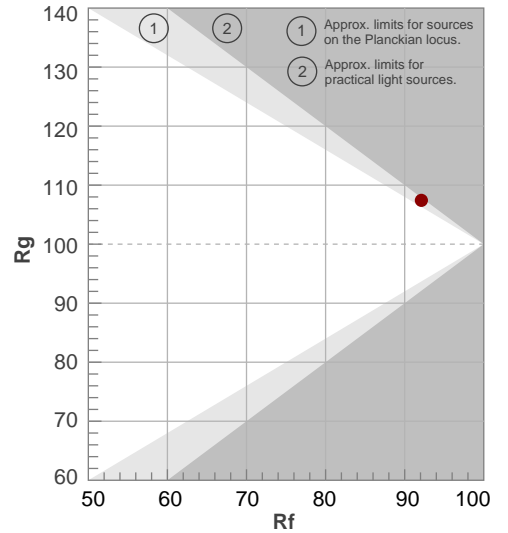

# BEAM DETAILS



Beam angle 50%	Field angle 10%	Cut off angle 2,5%	Intensity ratio in 120° cone	Intensity ratio in 90° cone
74,8°	130°	153,2°	81,9%	53,6%

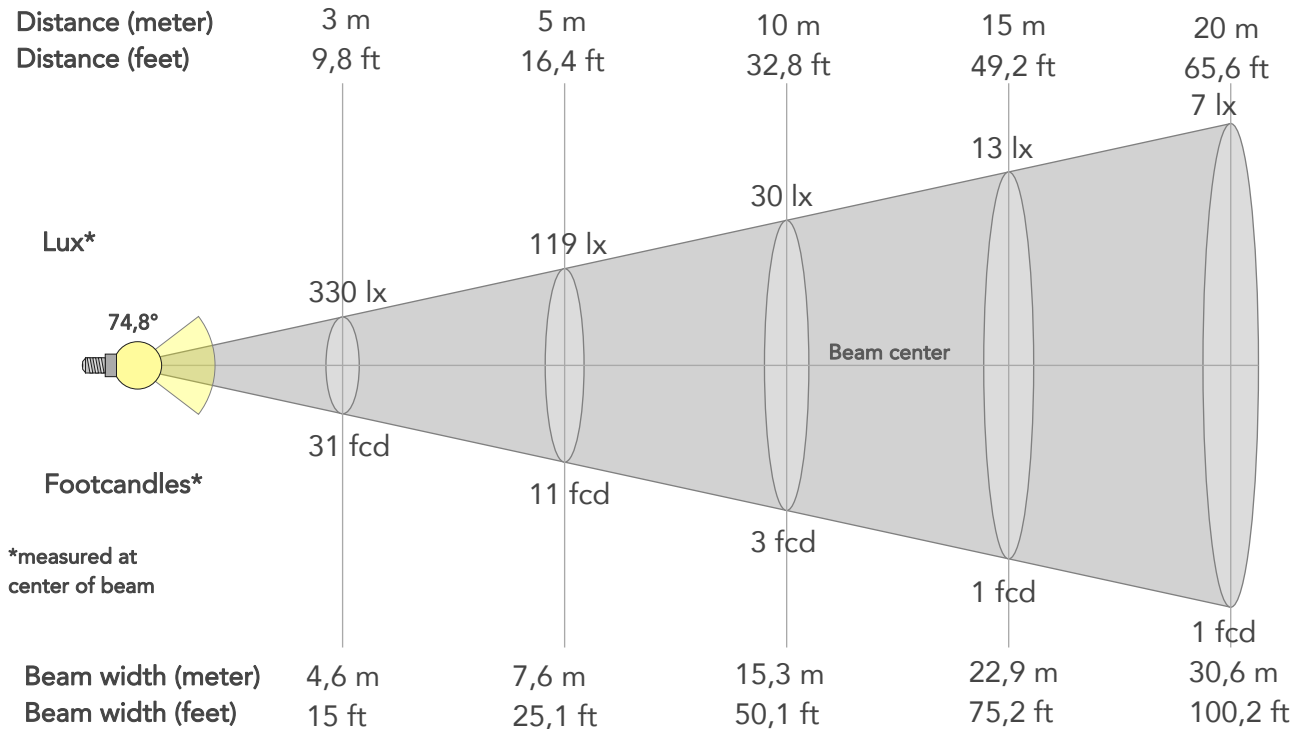

## BEAM INTENSITIES AND WIDTHS

Distance	1m	2m	3m	4m	5m	7,5m	10m	15m	20m	25m	30m	40m	50m
Distance	3,3ft	6,6ft	9,8ft	13,1ft	16,4ft	24,6ft	32,8ft	49,2ft	65,6ft	82ft	98,4ft	131,2ft	164ft
Lux	2970lx	743lx	330lx	186lx	119lx	53lx	30lx	13lx	7lx	5lx	3lx	2lx	1lx
Footcand.	276fcd	69fcd	31fcd	17fcd	11fcd	5fcd	3fcd	1fcd	1fcd	0fcd	0fcd	0fcd	0fcd
Beam wid.	1,5m	3,1m	4,6m	6,1m	7,6m	11,5m	15,3m	22,9m	30,6m	38,2m	45,8m	61,1m	76,4m
Beam wid.	5ft	10,1ft	15ft	20ft	25,1ft	37,6ft	50,1ft	75,2ft	100,2ft	125,3ft	150,4ft	200,5ft	250,6ft

## LINEAR DISTRIBUTION DIAGRAM

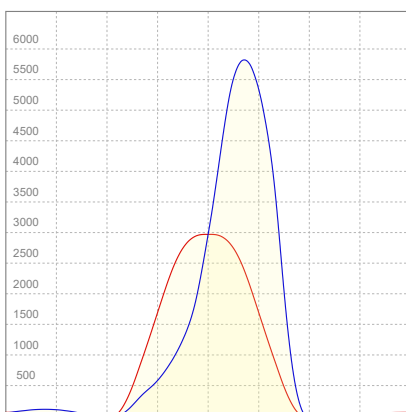

## ELECTRICAL SPECIFICATIONS

Input voltage	Input current	Input power	Effeciency
228V	1,01A	216,4W	47lm/W

## ISO CANDELA DIAGRAM

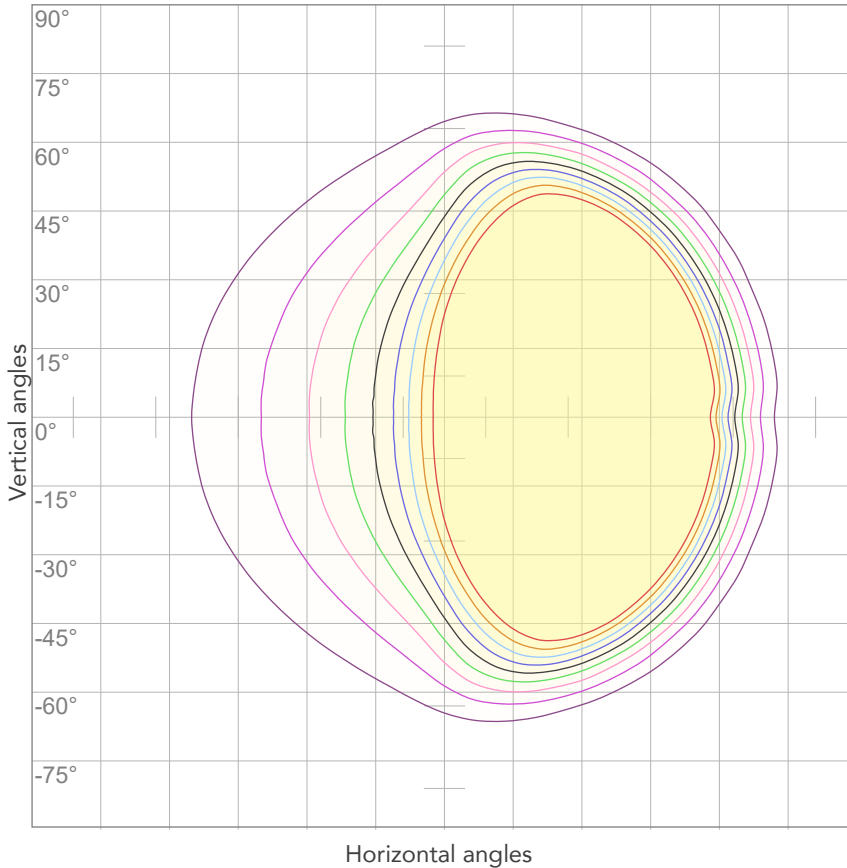

10%	297 cd
20%	594 cd
30%	891 cd
40%	1188 cd
50%	1485 cd
60%	1782 cd
70%	2079 cd
80%	2376 cd

Conditions:

Number of c-planes: 64

Candela at center: 2970 cd

## ISO LUX DIAGRAM

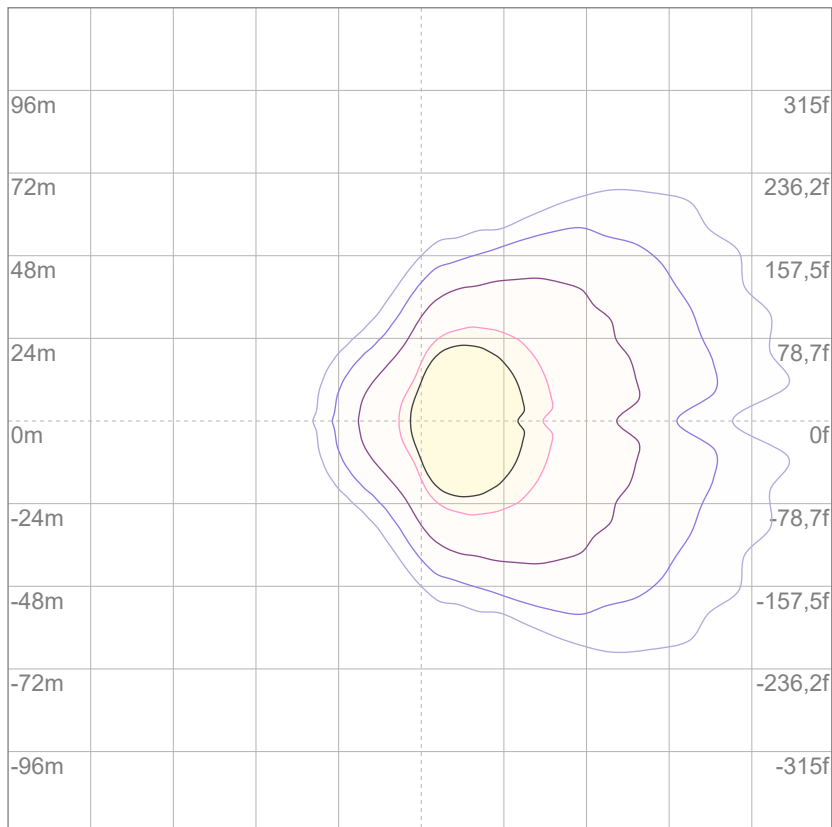

Mounting height: 10 meters (33 feet)

3%	0,891 lx
5%	1,49 lx
10%	2,97 lx
30%	8,91 lx
50%	14,9 lx

Conditions:

Number of c-planes: 64

Lux at center: 29,7 lx

*Lux distribution on a surface when lamp is mounted at 10 meters from the surface.*



Total lumen output:

9588 lm

Peak candela output:

5609 cd

Light quality:

CRI: 93,8

Color temperature:

3935 K

**PRODUCT NAME:**

ECLEXPFL300 FC

**MEASUREMENT CONDITIONS:**

Beam angle:

Asymmetric

Target:

4000K

Operator:

Salvatore Giglio

Date and time:

30/03/2023 14:54:07

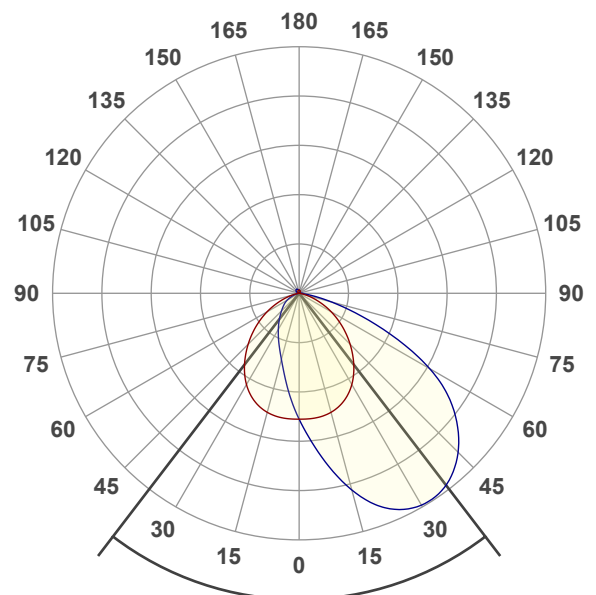

Beam angle 50%: 74,9°

Field angle 10%: 130,4°

Cut off angle 2.5%: 153,9°

Spectra

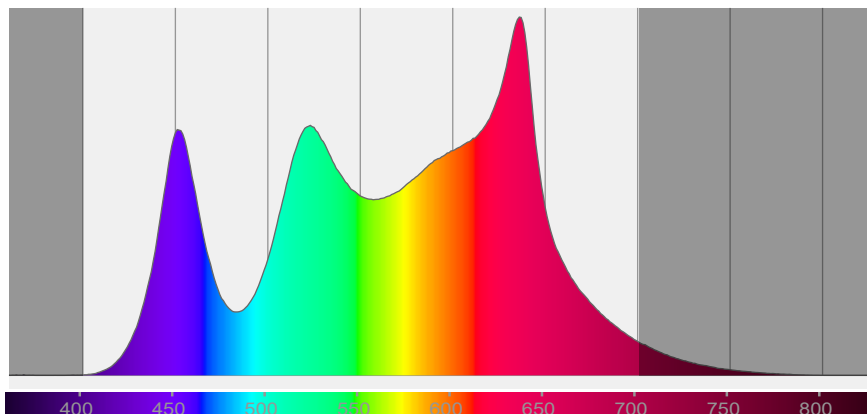

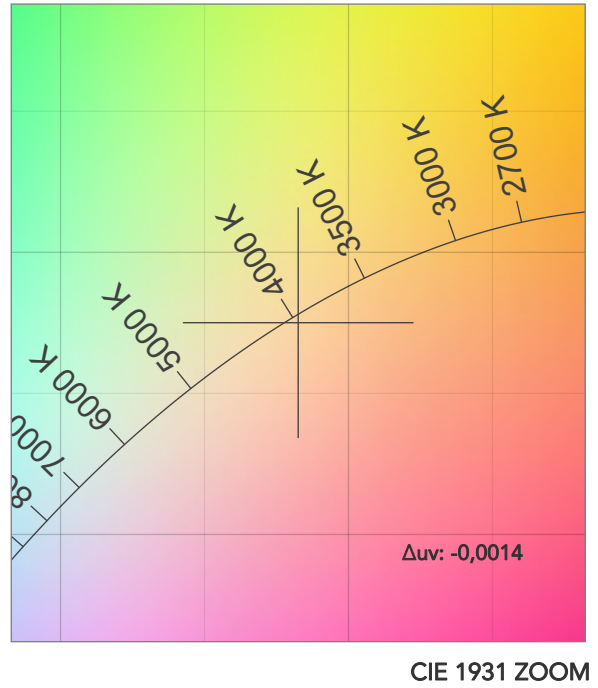
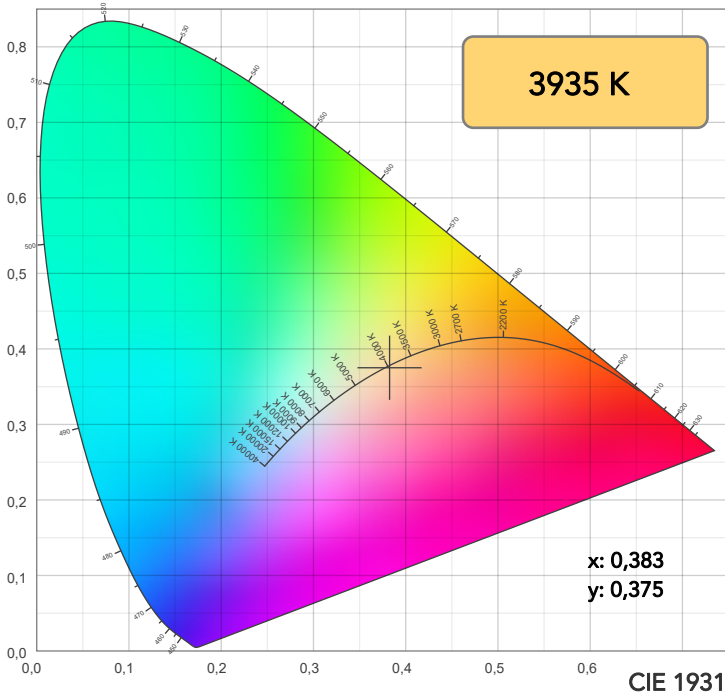

TM30: 92,9

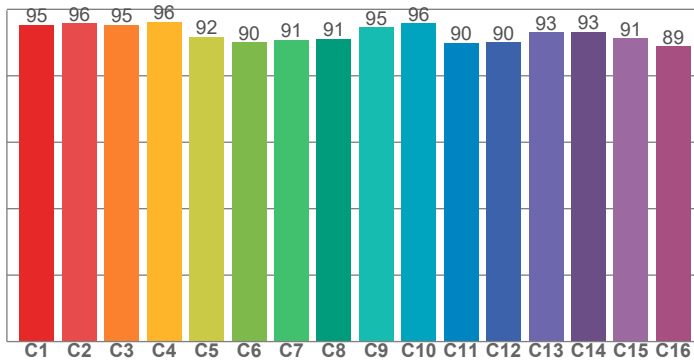

CRI: 93,8 (R1-R8)

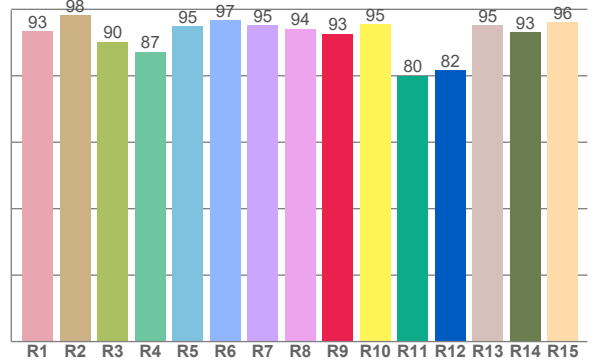

CRI R values, only R1-R8 are used to calculate final CRI value

R1	R2	R3	R4	R5	R6	R7	R8	R9	R10	R11	R12	R13	R14	R15
93,5	98,3	90,2	87,2	94,9	96,7	95,3	94,2	92,7	95,4	80,0	81,6	95,1	93,1	96,2

TM30 C values, 16 binned values out of total of 99 C values

C1	C2	C3	C4	C5	C6	C7	C8	C9	C10	C11	C12	C13	C14	C15	C16
95,3	95,7	95,3	96,3	91,7	90,0	90,9	91,1	94,5	95,7	89,8	90,1	93,1	93,2	91,3	88,9

CQS Q values

Q1	Q2	Q3	Q4	Q5	Q6	Q7	Q8	Q9	Q10	Q11	Q12	Q13	Q14	Q15
99,1	98,9	89,5	97,4	94,4	89,7	93,7	98,2	94,9	96,0	97,5	95,9	95,9	97,7	99,0

CQS: 94,9

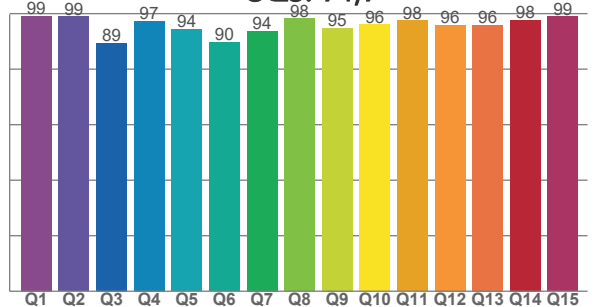

COLOR PARAMETERS

Color temperature	Color rendering index	Red component	Color fidelity	Color gamut	Color quality scale	Television lighting index	Color coordinate cie 1931	Color coordinate cie 1931	Color deviation from black body
CCT	CRI	CRI R9	TM30 Rf	TM30 Rg	CQS	TLCI	x	y	Δuv
3935 K	93,8	92,7	92,9	105,4	94,9	88	0,383	0,375	-0,0014

# TM30 DETAILS

**Rf 92,9**  
Fidelity index Rf

**Rg 105,4**  
Gammut index

Hue Bin	R <sub>f</sub>	Graphic shifts (%)	
		Chroma	Hue
1	95	1%	-1%
2	96	1%	-1%
3	95	1%	1%
4	96	0%	1%
5	92	1%	3%
6	90	6%	4%
7	91	6%	0%
8	91	4%	-1%
9	95	2%	0%
10	96	-1%	1%
11	90	2%	6%
12	90	4%	3%
13	93	5%	-1%
14	93	6%	3%
15	91	4%	-2%
16	89	5%	-5%

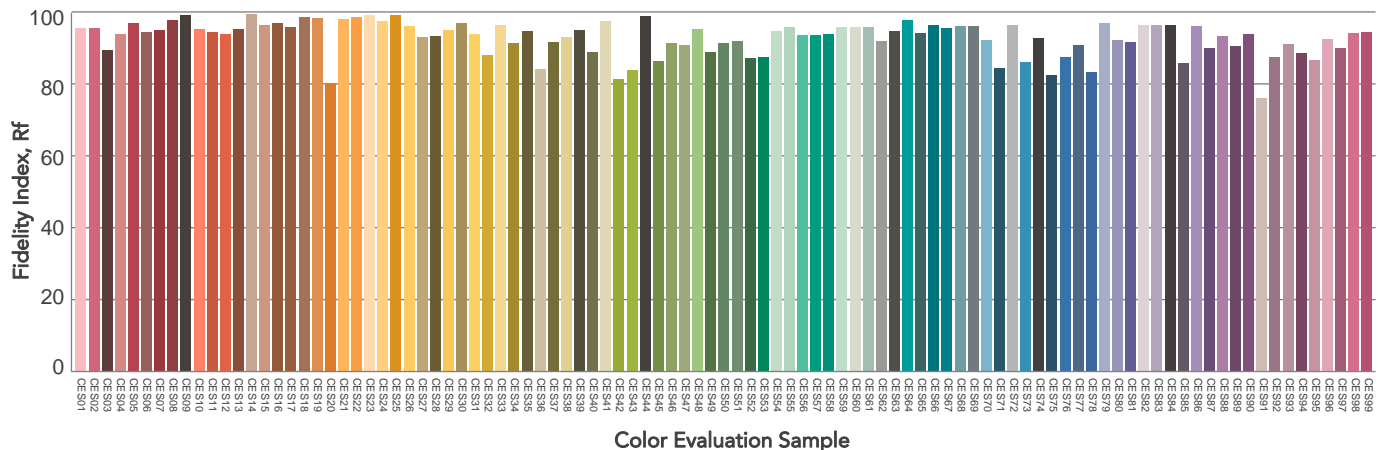
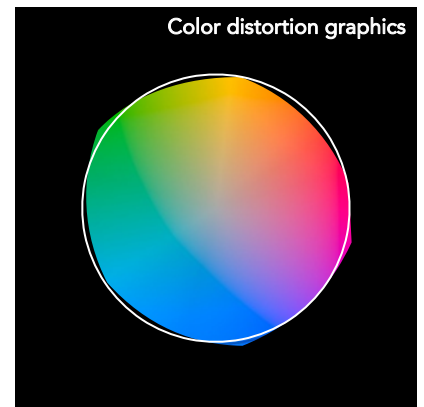
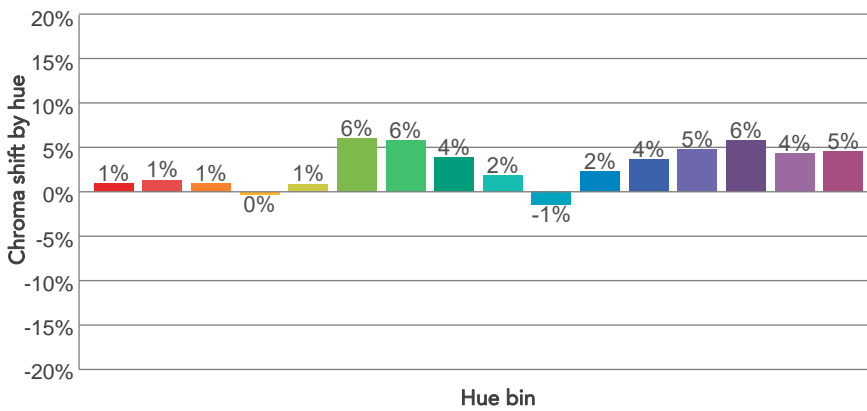
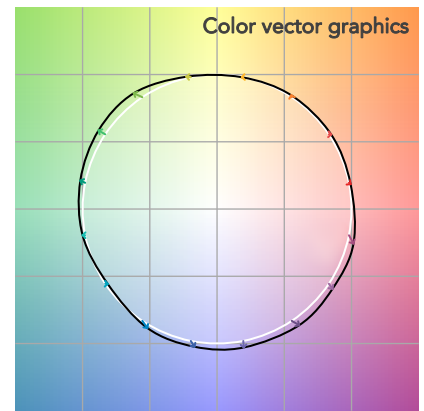
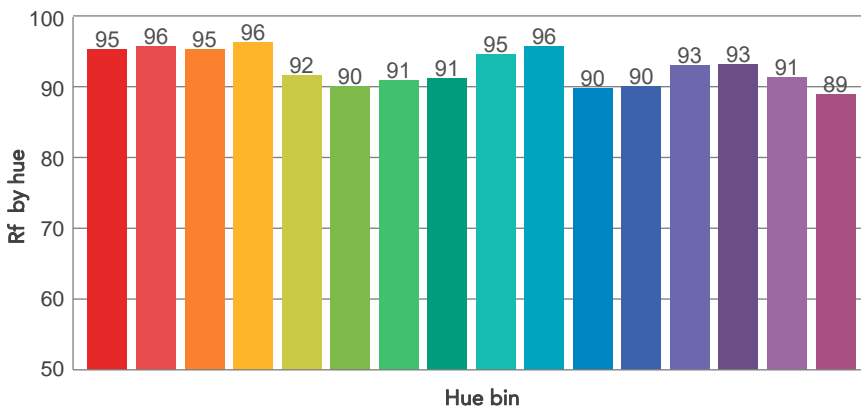
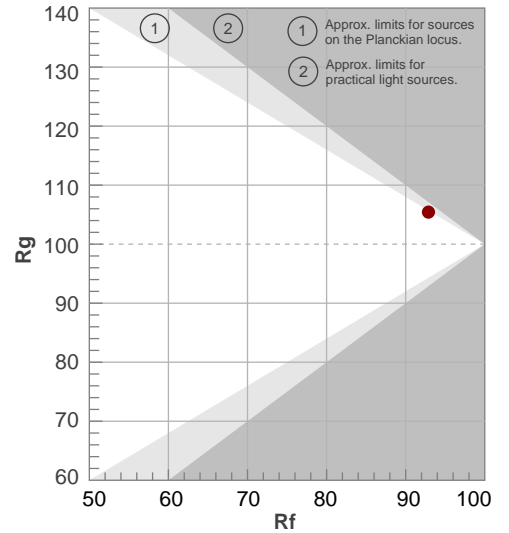

# BEAM DETAILS



Beam angle 50%	Field angle 10%	Cut off angle 2,5%	Intensity ratio in 120° cone	Intensity ratio in 90° cone
74,9°	130,4°	153,9°	81,6%	53,4%

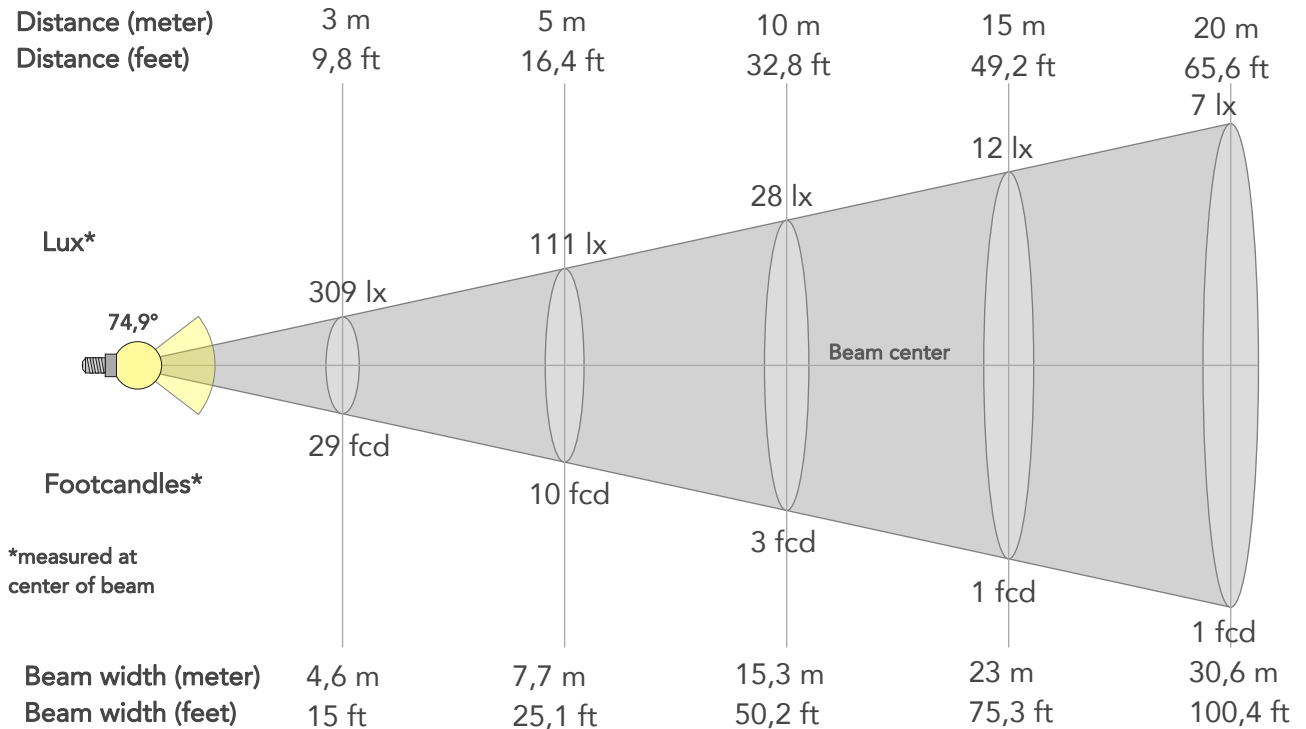

## BEAM INTENSITIES AND WIDTHS

Distance	1m	2m	3m	4m	5m	7,5m	10m	15m	20m	25m	30m	40m	50m
Distance	3,3ft	6,6ft	9,8ft	13,1ft	16,4ft	24,6ft	32,8ft	49,2ft	65,6ft	82ft	98,4ft	131,2ft	164ft
Lux	2783lx	696lx	309lx	174lx	111lx	49lx	28lx	12lx	7lx	4lx	3lx	2lx	1lx
Footcand.	259fcd	65fcd	29fcd	16fcd	10fcd	5fcd	3fcd	1fcd	1fcd	0fcd	0fcd	0fcd	0fcd
Beam wid.	1,5m	3,1m	4,6m	6,1m	7,7m	11,5m	15,3m	23m	30,6m	38,3m	45,9m	61,2m	76,5m
Beam wid.	5,1ft	10,1ft	15ft	20,1ft	25,1ft	37,7ft	50,2ft	75,3ft	100,4ft	125,5ft	150,6ft	200,9ft	251,1ft

## LINEAR DISTRIBUTION DIAGRAM

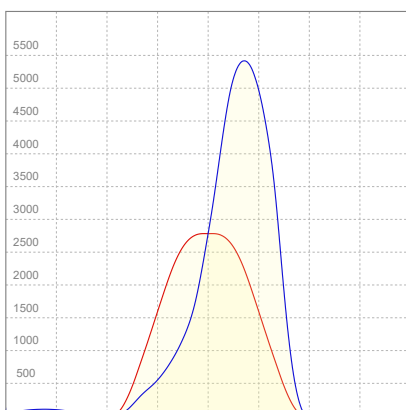

## ELECTRICAL SPECIFICATIONS

Input voltage	Input current	Input power	Effeciency
225V	1,02A	218,9W	44lm/W



## ISO CANDELA DIAGRAM

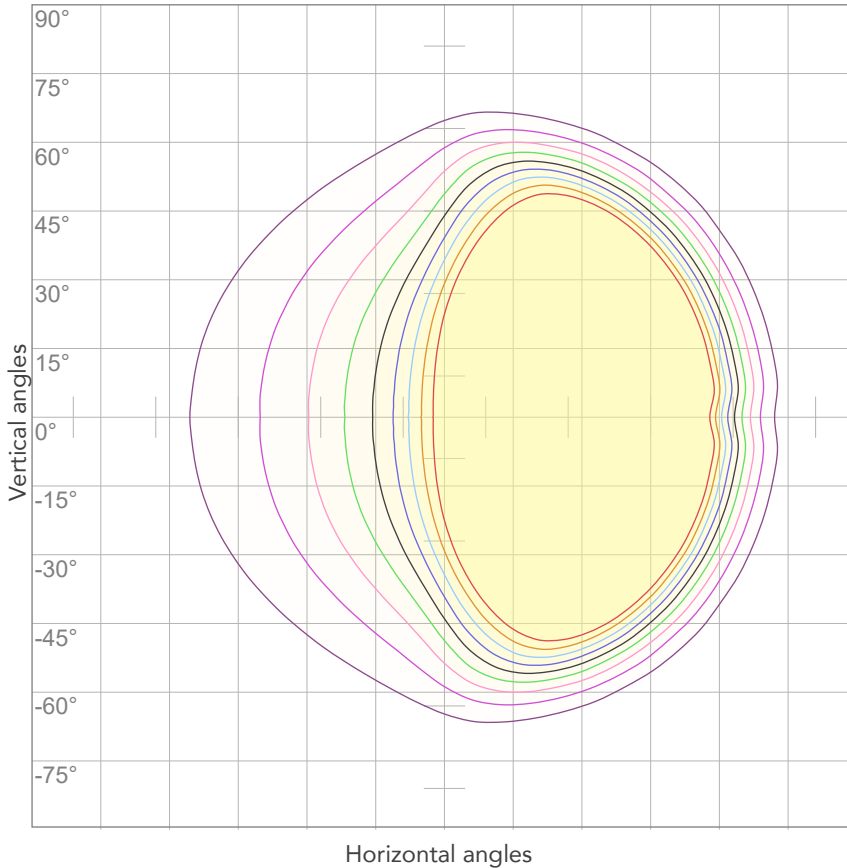

10%	278 cd
20%	557 cd
30%	835 cd
40%	1113 cd
50%	1392 cd
60%	1670 cd
70%	1948 cd
80%	2226 cd

Conditions:

Number of c-planes: 64

Candela at center: 2783 cd

## ISO LUX DIAGRAM

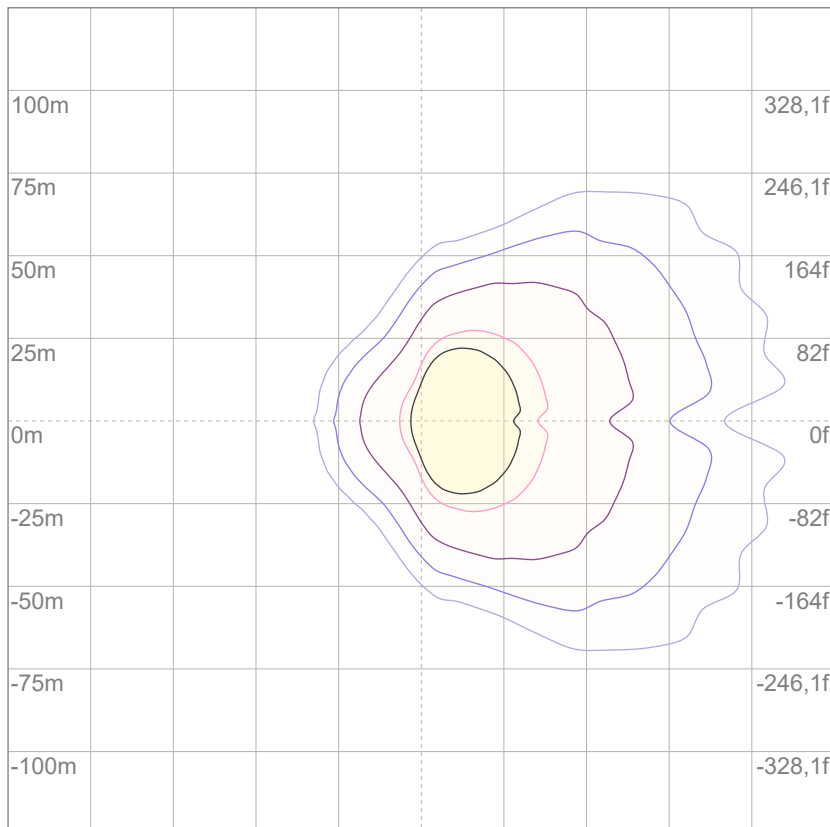

3%	0,835 lx
5%	1,39 lx
10%	2,78 lx
30%	8,35 lx
50%	13,9 lx

Conditions:

Number of c-planes: 64

Lux at center: 27,8 lx

*Lux distribution on a surface when lamp is mounted at 10 meters from the surface.*

Mounting height: 10 meters (33 feet)



Total lumen output:

9474 lm

Peak candela output:

5436 cd

Light quality:

CRI: 93,6

Color temperature:

5492 K

**PRODUCT NAME:**

ECLEXPFL300 FC

**MEASUREMENT CONDITIONS:**

Beam angle:

Asymmetric

Target:

5600K

Operator:

Salvatore Giglio

Date and time:

30/03/2023 15:17:35

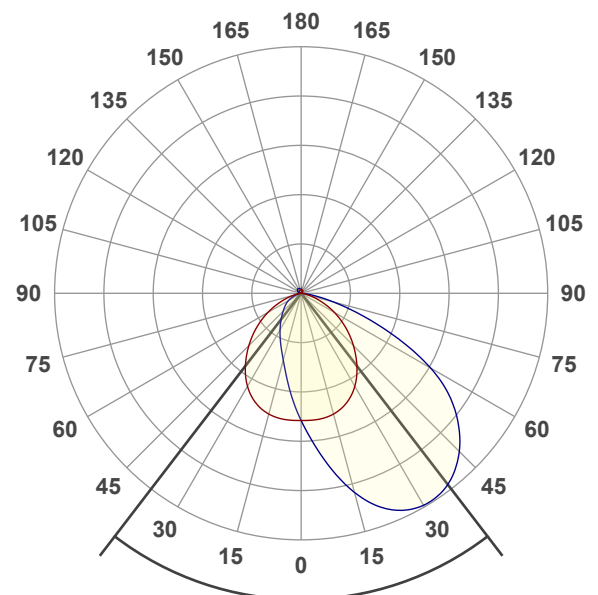

Beam angle 50%: 75°

Field angle 10%: 131,1°

Cut off angle 2.5%: 186,7°

Spectra

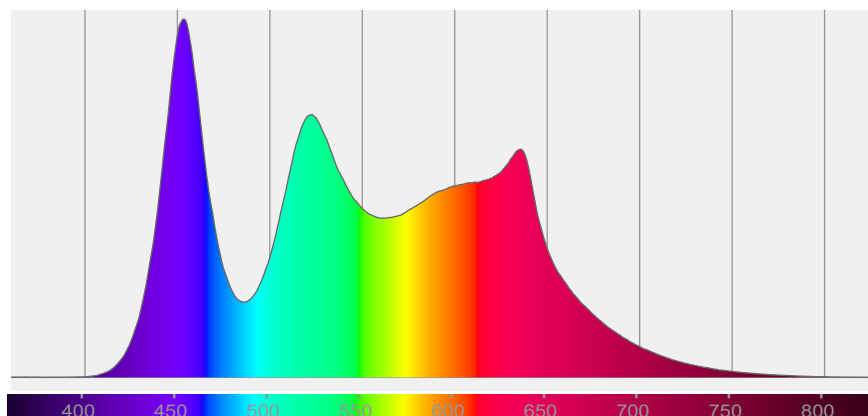

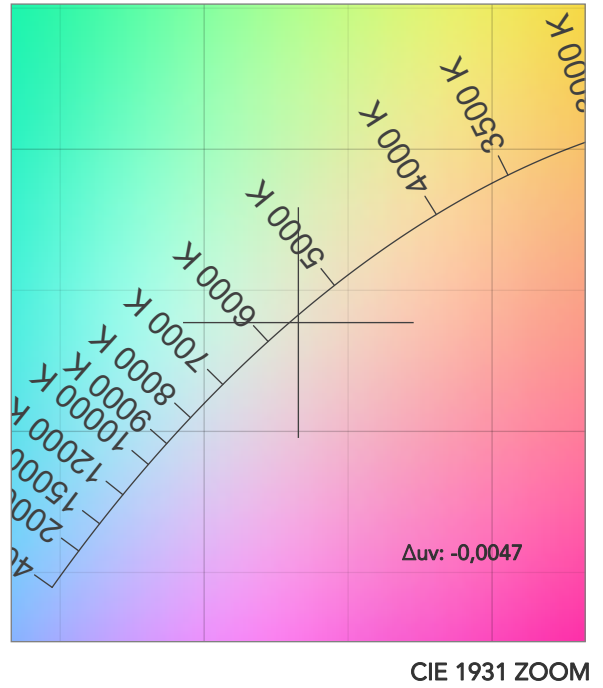
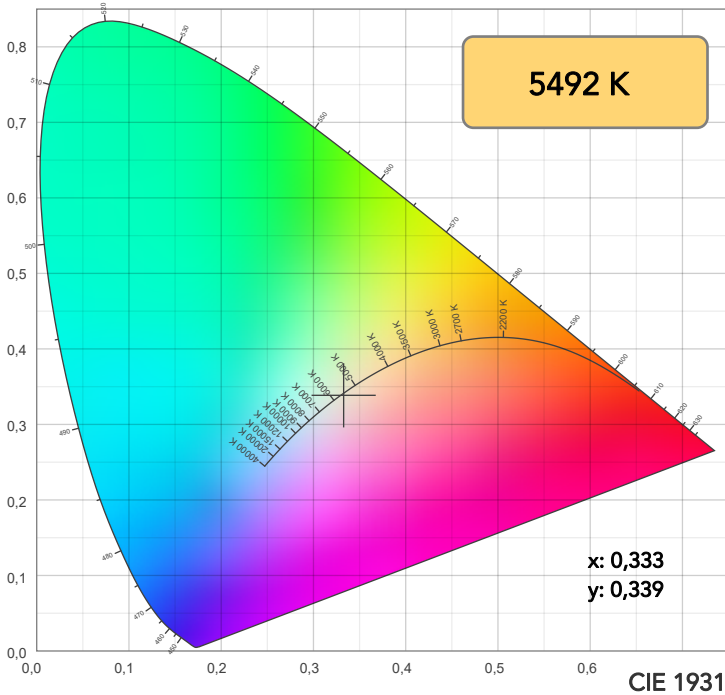

TM30: 91,7

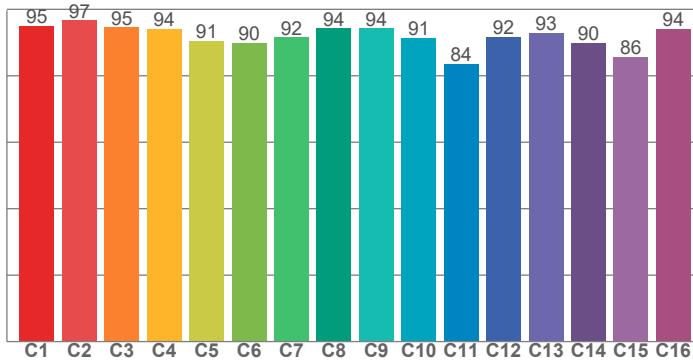

CRI: 93,6 (R1-R8)

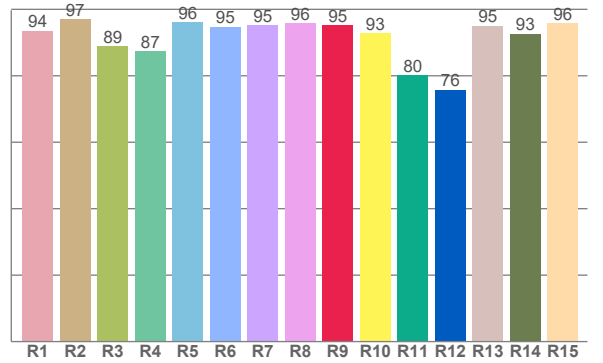

CRI R values, only R1-R8 are used to calculate final CRI value

R1	R2	R3	R4	R5	R6	R7	R8	R9	R10	R11	R12	R13	R14	R15
93,5	97,0	89,0	87,4	96,0	94,8	95,2	95,8	95,2	92,7	80,1	75,8	95,1	92,7	95,8

TM30 C values, 16 binned values out of total of 99 C values

C1	C2	C3	C4	C5	C6	C7	C8	C9	C10	C11	C12	C13	C14	C15	C16
95,1	96,6	94,6	94,0	90,6	89,9	91,6	94,3	94,2	91,4	83,5	91,8	93,0	89,9	85,7	94,1

CQS Q values

Q1	Q2	Q3	Q4	Q5	Q6	Q7	Q8	Q9	Q10	Q11	Q12	Q13	Q14	Q15
99,0	97,1	84,4	91,4	97,9	92,4	95,0	97,7	92,4	92,5	98,5	99,6	98,8	97,2	98,9

CQS: 94,0

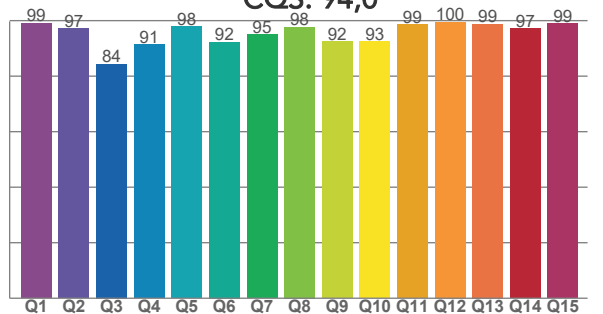

COLOR PARAMETERS

Color temperature	Color rendering index	Red component	Color fidelity	Color gamut	Color quality scale	Television lighting index	Color coordinate cie 1931	Color coordinate cie 1931	Color deviation from black body
CCT	CRI	CRI R9	TM30 Rf	TM30 Rg	CQS	TLCI	x	y	Δuv
5492 K	93,6	95,2	91,7	105,3	94,0	93	0,333	0,339	-0,0047

# TM30 DETAILS

**Rf 91,7**  
Fidelity index Rf

**Rg 105,3**  
Gammut index

Hue Bin	R <sub>f</sub>	Graphic shifts (%)	
		Chroma	Hue
1	95	0%	-1%
2	97	1%	0%
3	95	1%	2%
4	94	0%	2%
5	91	0%	3%
6	90	6%	4%
7	92	5%	1%
8	94	2%	0%
9	94	-1%	3%
10	91	-1%	5%
11	84	2%	10%
12	92	3%	5%
13	93	6%	2%
14	90	5%	3%
15	86	11%	-6%
16	94	3%	-1%

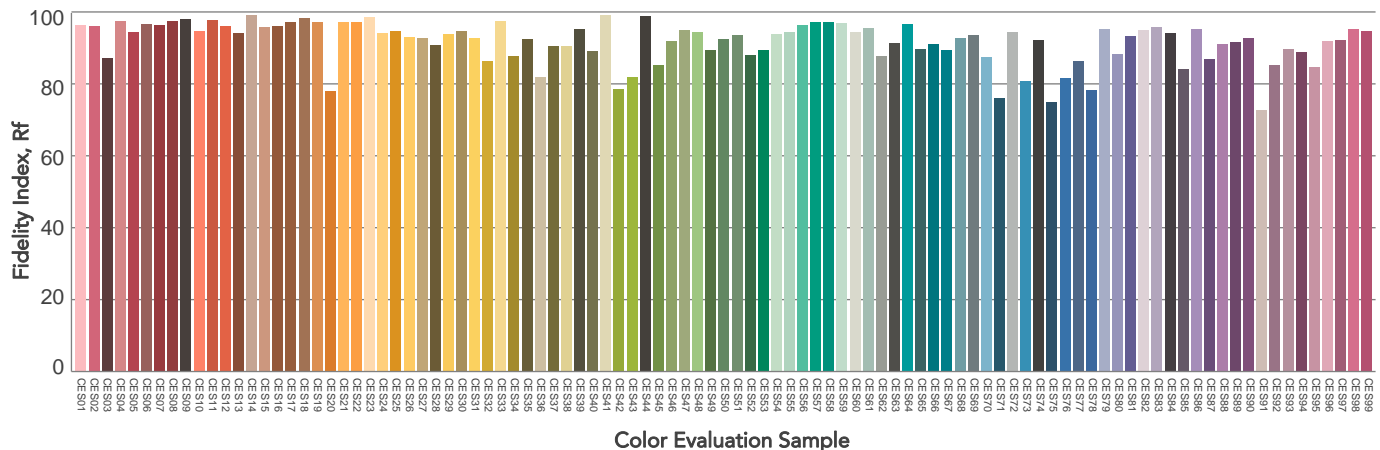
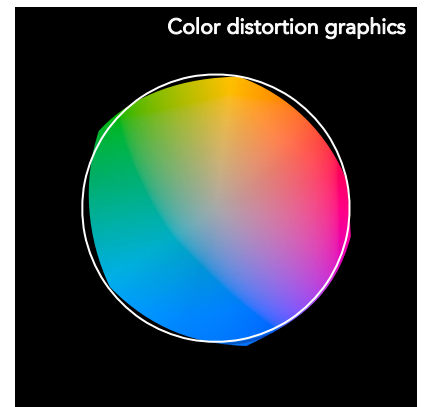
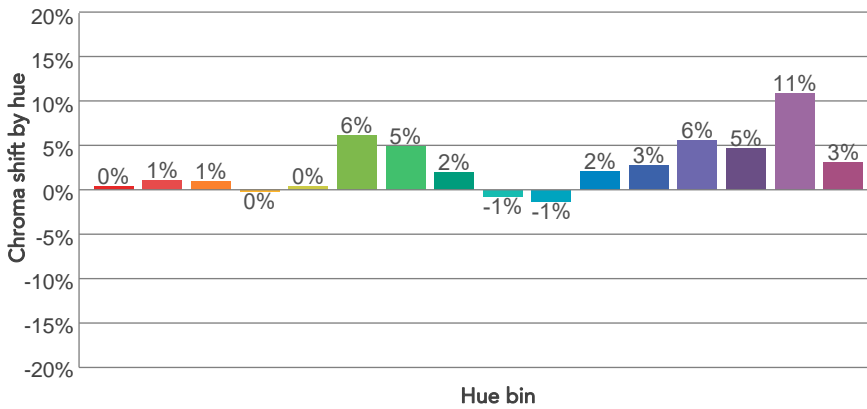
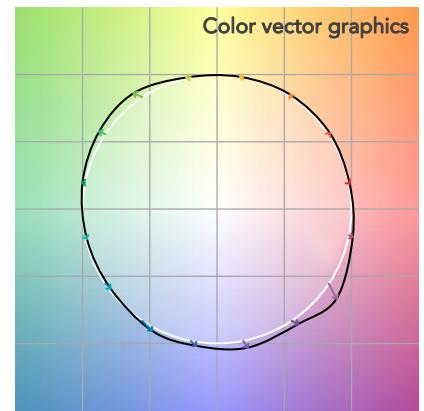
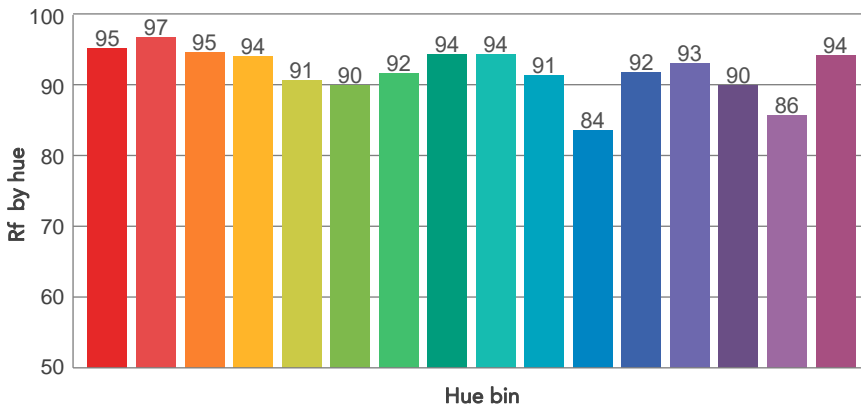
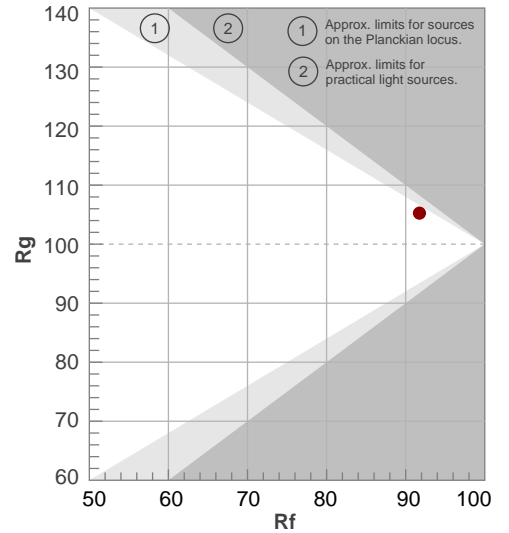

# BEAM DETAILS



Beam angle 50%	Field angle 10%	Cut off angle 2,5%	Intensity ratio in 120° cone	Intensity ratio in 90° cone
75°	131,1°	186,7°	80,7%	52,8%

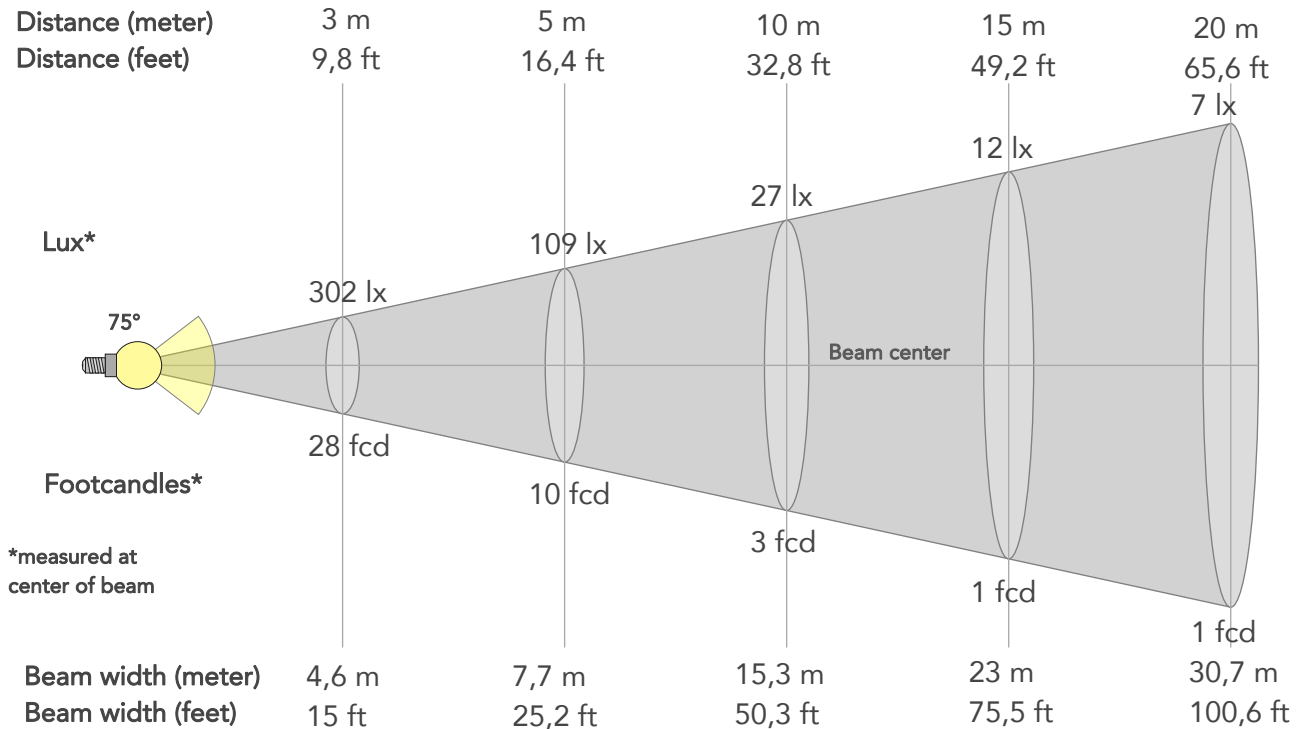

## BEAM INTENSITIES AND WIDTHS

Distance	1m	2m	3m	4m	5m	7,5m	10m	15m	20m	25m	30m	40m	50m
Distance	3,3ft	6,6ft	9,8ft	13,1ft	16,4ft	24,6ft	32,8ft	49,2ft	65,6ft	82ft	98,4ft	131,2ft	164ft
Lux	2717lx	679lx	302lx	170lx	109lx	48lx	27lx	12lx	7lx	4lx	3lx	2lx	1lx
Footcand.	252fcd	63fcd	28fcd	16fcd	10fcd	4fcd	3fcd	1fcd	1fcd	0fcd	0fcd	0fcd	0fcd
Beam wid.	1,5m	3,1m	4,6m	6,1m	7,7m	11,5m	15,3m	23m	30,7m	38,3m	46m	61,4m	76,7m
Beam wid.	5,1ft	10,1ft	15ft	20,1ft	25,2ft	37,7ft	50,3ft	75,5ft	100,6ft	125,8ft	150,9ft	201,2ft	251,5ft

## LINEAR DISTRIBUTION DIAGRAM

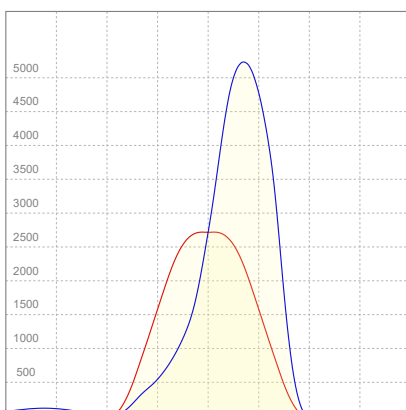

## ELECTRICAL SPECIFICATIONS

Input voltage	Input current	Input power	Effeciency
225V	1,03A	218,9W	43lm/W

## ISO CANDELA DIAGRAM

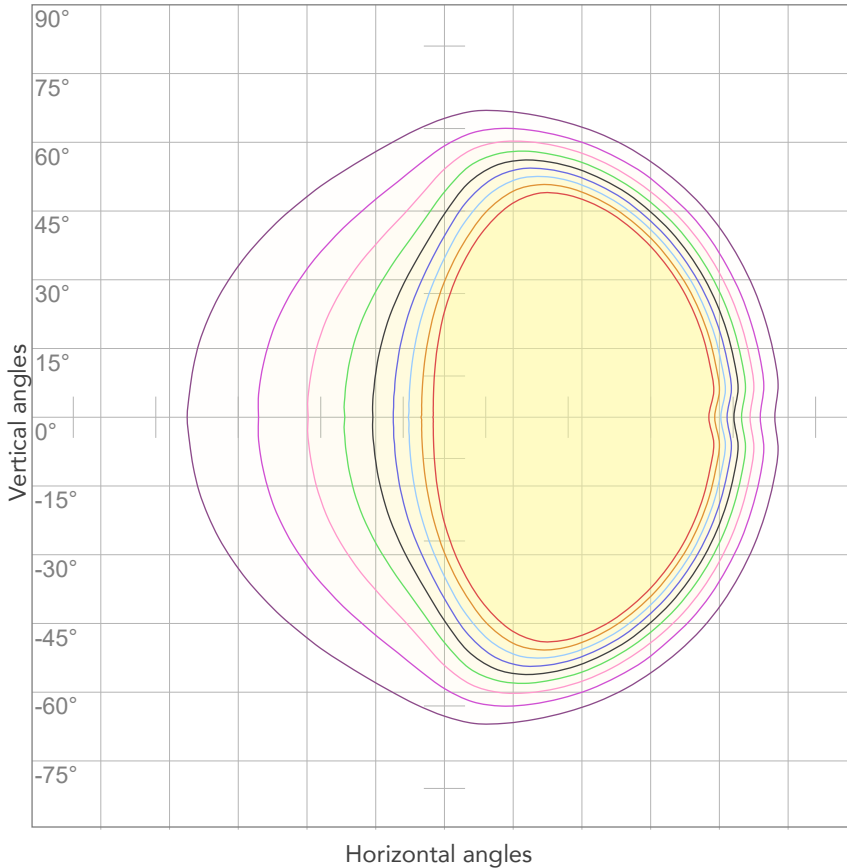

10%	272 cd
20%	543 cd
30%	815 cd
40%	1087 cd
50%	1358 cd
60%	1630 cd
70%	1902 cd
80%	2173 cd

Conditions:

Number of c-planes: 64

Candela at center: 2717 cd

## ISO LUX DIAGRAM

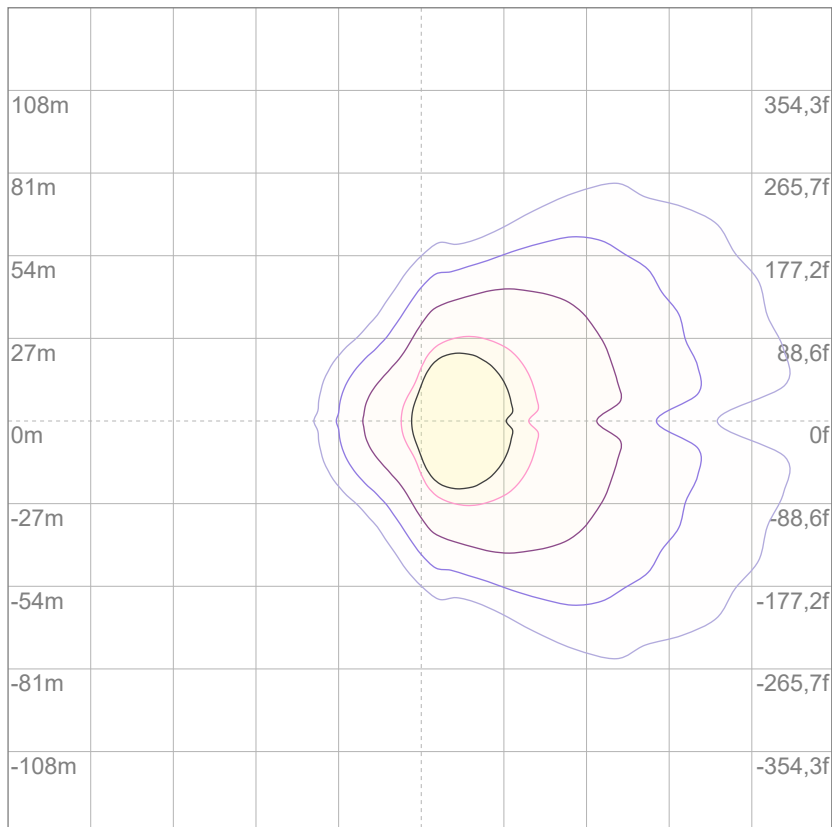

3%	0,815 lx
5%	1,36 lx
10%	2,72 lx
30%	8,15 lx
50%	13,6 lx

Conditions:

Number of c-planes: 64

Lux at center: 27,2 lx

*Lux distribution on a surface when lamp is mounted at 10 meters from the surface.*



Total lumen output:

9406 lm

Peak candela output:

5387 cd

Light quality:

CRI: 93,6

Color temperature:

5896 K

**PRODUCT NAME:**

ECLEXPOFL300 FC

**MEASURAMENT CONDITIONS:**

Beam angle:

Asymmetric

Target:

6000K

Operator:

Salvatore Giglio

Date and time:

30/03/2023 15:40:59

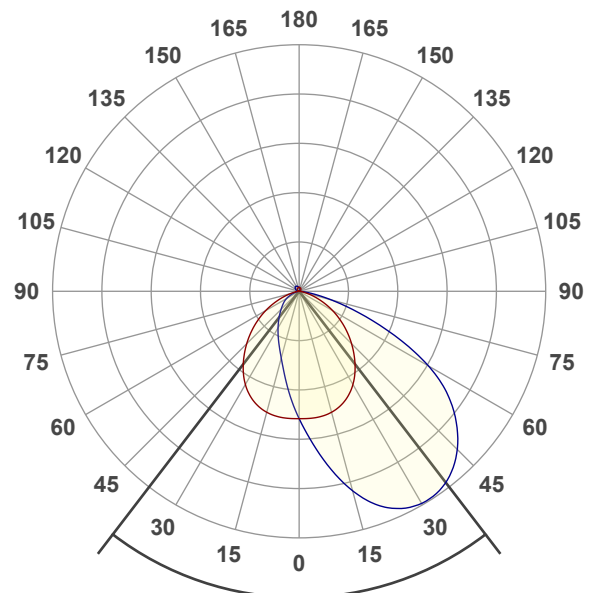

Beam angle 50%: 74,9°

Field angle 10%: 131,1°

Cut off angle 2.5%: 192,7°

Spectra

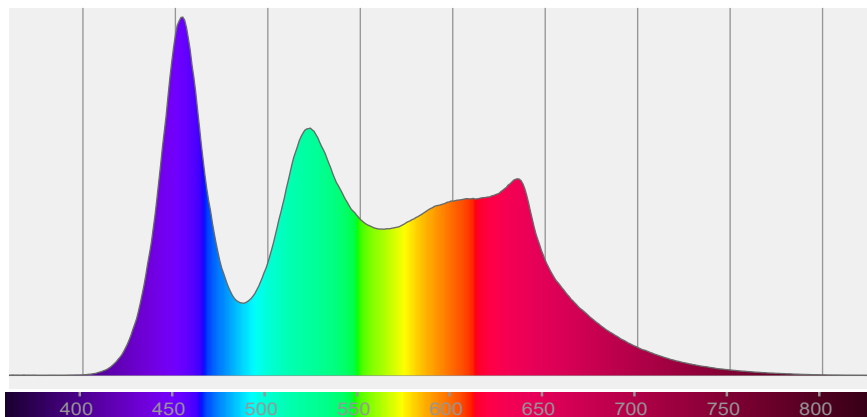

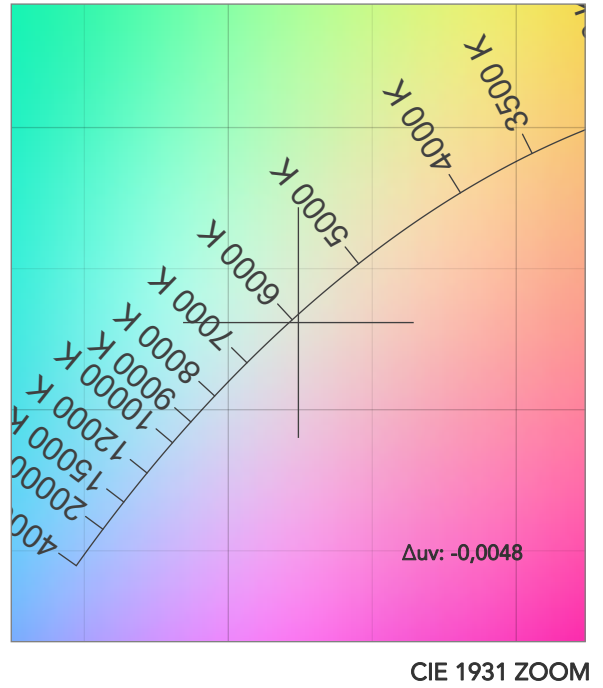
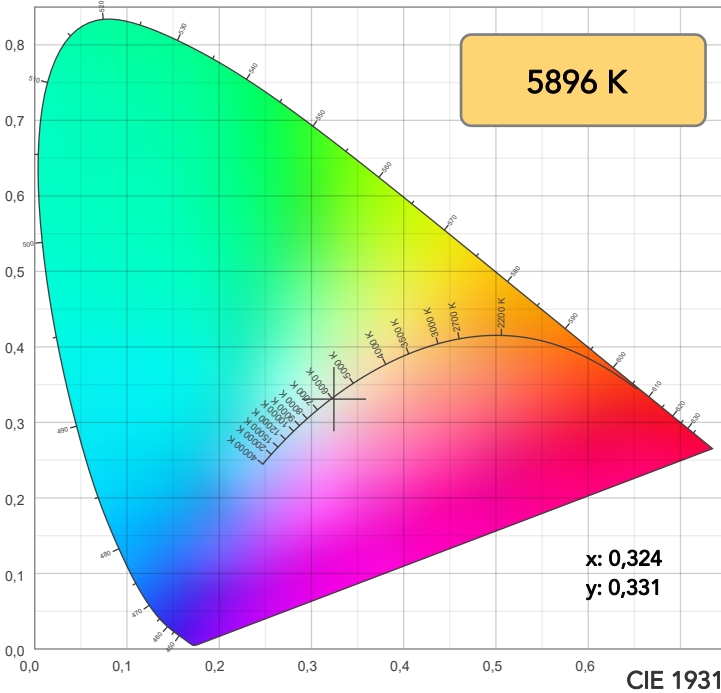

TM30: 91,5

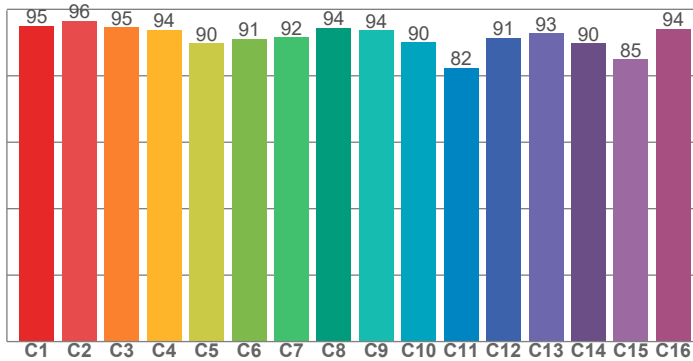

CRI: 93,6 (R1-R8)

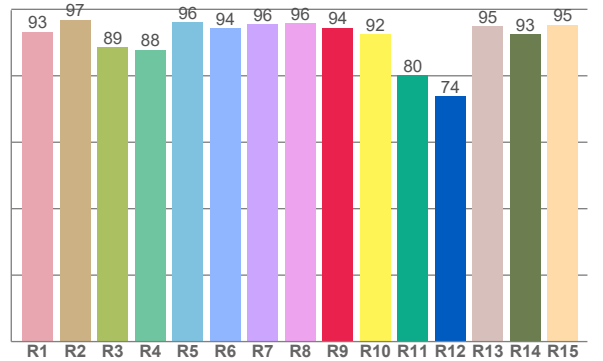

CRI R values, only R1-R8 are used to calculate final CRI value

R1	R2	R3	R4	R5	R6	R7	R8	R9	R10	R11	R12	R13	R14	R15
93,3	96,9	88,7	87,8	96,2	94,4	95,5	95,9	94,5	92,5	80,2	73,8	94,9	92,5	95,4

TM30 C values, 16 binned values out of total of 99 C values

C1	C2	C3	C4	C5	C6	C7	C8	C9	C10	C11	C12	C13	C14	C15	C16
94,9	96,5	94,6	93,8	89,8	91,1	91,5	94,4	93,6	90,1	82,5	91,4	92,8	89,8	84,9	94,1

CQS Q values

Q1	Q2	Q3	Q4	Q5	Q6	Q7	Q8	Q9	Q10	Q11	Q12	Q13	Q14	Q15
99,1	97,1	84,0	90,1	98,4	93,3	95,6	97,4	92,1	92,3	98,3	99,6	98,8	97,0	98,6

CQS: 93,8

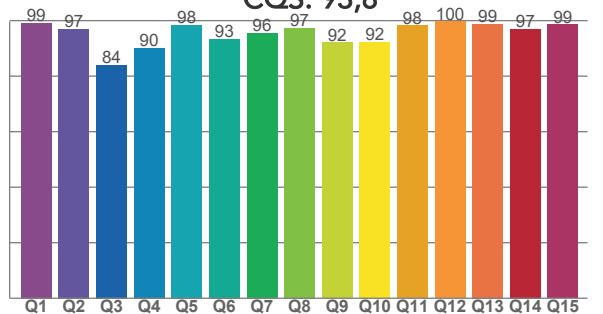

COLOR PARAMETERS

Color temperature	Color rendering index	Red component	Color fidelity	Color gamut	Color quality scale	Television lighting index	Color coordinate cie 1931	Color coordinate cie 1931	Color deviation from black body
CCT	CRI	CRI R9	TM30 Rf	TM30 Rg	CQS	TLCI	x	y	Δuv
5896 K	93,6	94,5	91,5	105,1	93,8	93	0,324	0,331	-0,0048



# TM30 DETAILS

**Rf 91,5**  
Fidelity index Rf

**Rg 105,1**  
Gammut index

Hue Bin	R <sub>f</sub>	Graphic shifts (%)	
		Chroma	Hue
1	95	0%	0%
2	96	1%	0%
3	95	1%	2%
4	94	-1%	2%
5	90	0%	3%
6	91	5%	4%
7	92	6%	0%
8	94	2%	1%
9	94	-1%	4%
10	90	-1%	6%
11	82	2%	11%
12	91	3%	5%
13	93	6%	3%
14	90	5%	3%
15	85	12%	-6%
16	94	3%	0%

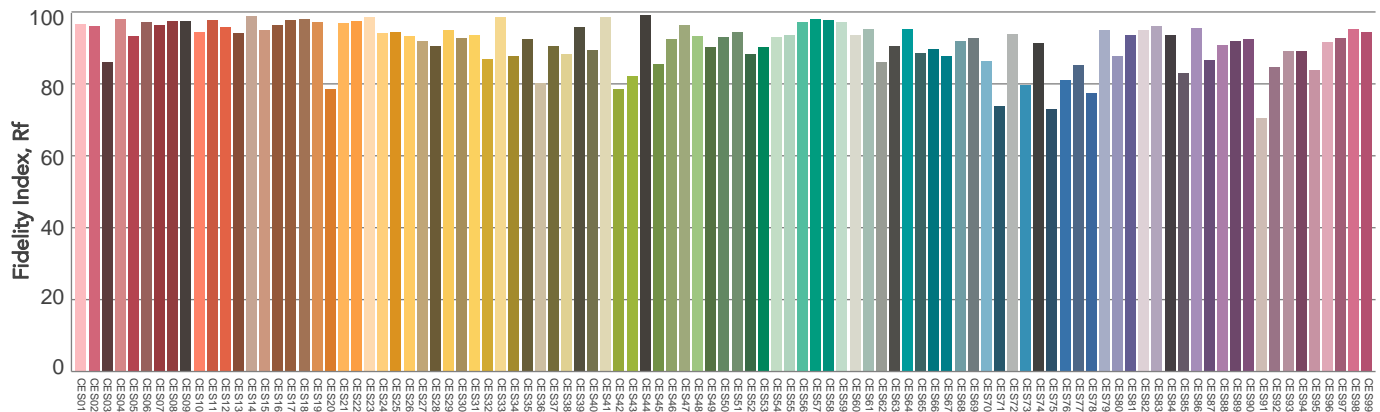
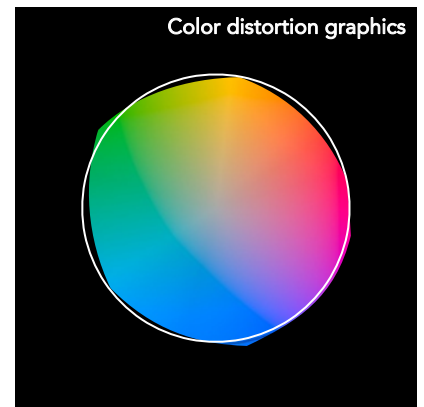
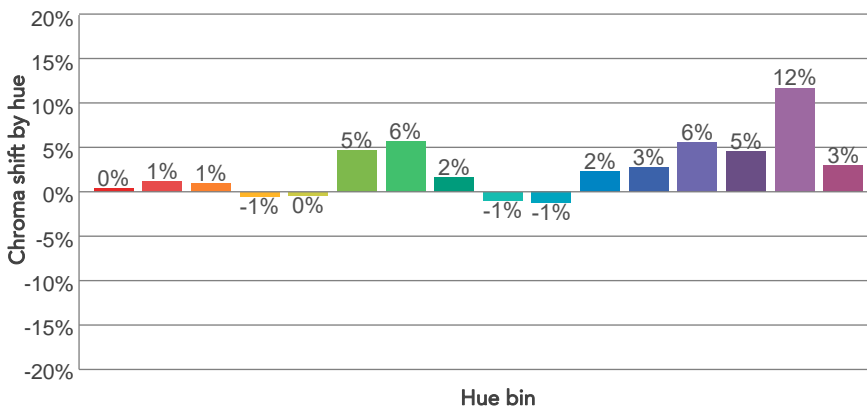
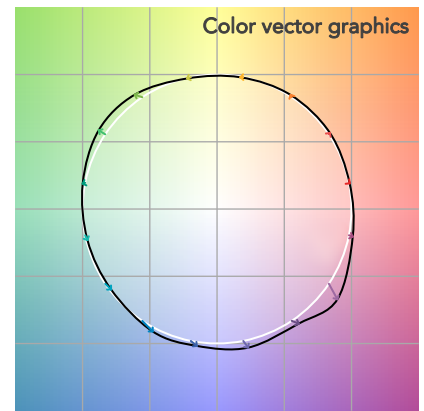
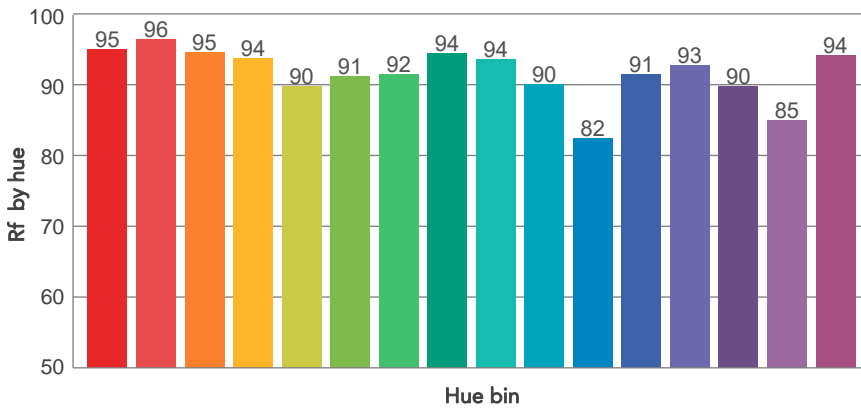
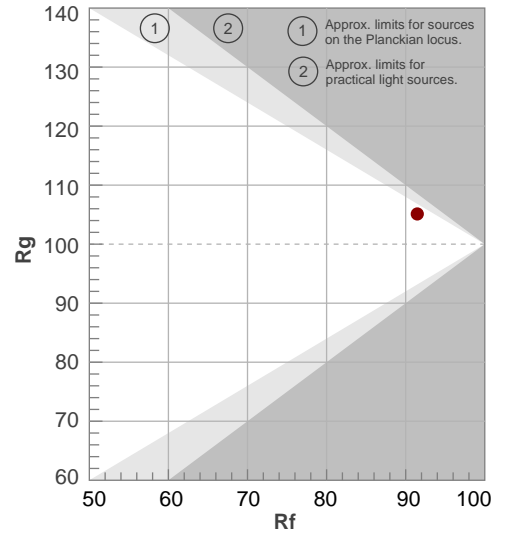

# BEAM DETAILS



Beam angle 50%	Field angle 10%	Cut off angle 2,5%	Intensity ratio in 120° cone	Intensity ratio in 90° cone
74,9°	131,1°	192,7°	80,6%	52,8%

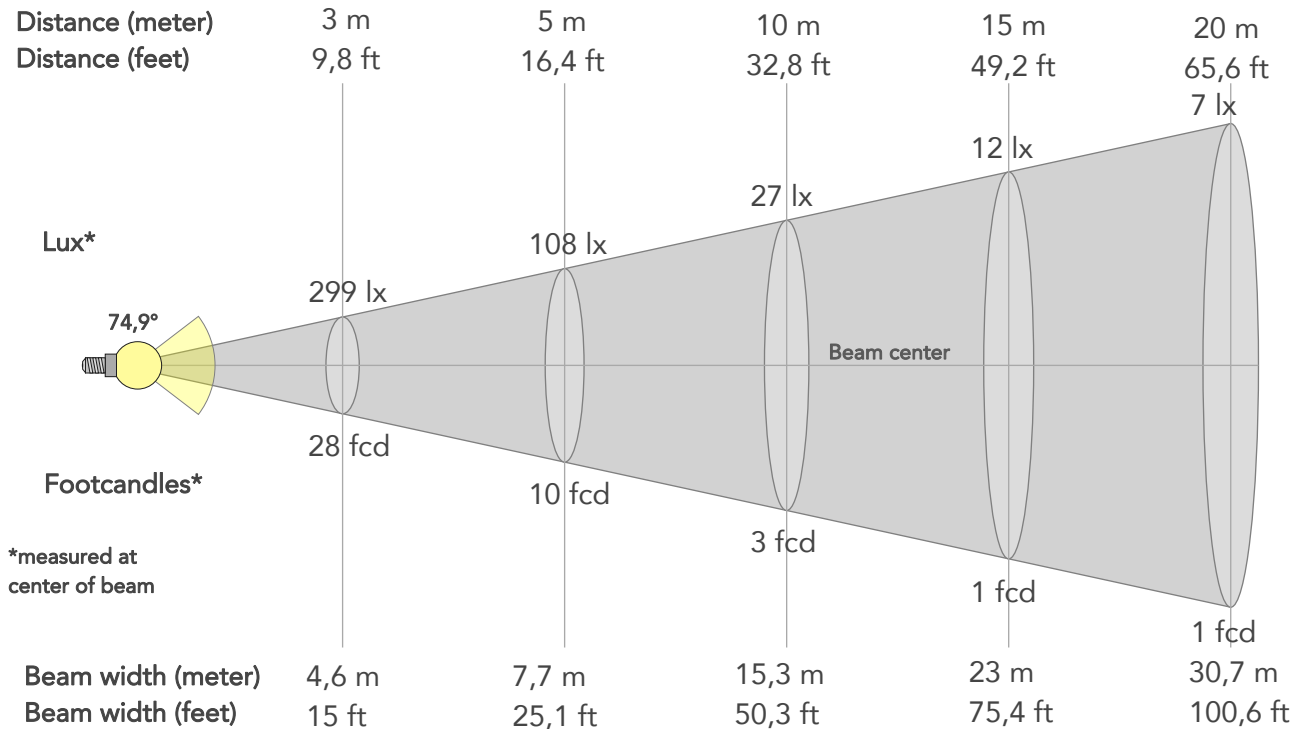

## BEAM INTENSITIES AND WIDTHS

Distance	1m	2m	3m	4m	5m	7,5m	10m	15m	20m	25m	30m	40m	50m
Distance	3,3ft	6,6ft	9,8ft	13,1ft	16,4ft	24,6ft	32,8ft	49,2ft	65,6ft	82ft	98,4ft	131,2ft	164ft
Lux	2694lx	673lx	299lx	168lx	108lx	48lx	27lx	12lx	7lx	4lx	3lx	2lx	1lx
Footcand.	250fcd	63fcd	28fcd	16fcd	10fcd	4fcd	3fcd	1fcd	1fcd	0fcd	0fcd	0fcd	0fcd
Beam wid.	1,5m	3,1m	4,6m	6,1m	7,7m	11,5m	15,3m	23m	30,7m	38,3m	46m	61,3m	76,7m
Beam wid.	5,1ft	10,1ft	15ft	20,1ft	25,1ft	37,7ft	50,3ft	75,4ft	100,6ft	125,7ft	150,9ft	201,2ft	251,4ft

## LINEAR DISTRIBUTION DIAGRAM

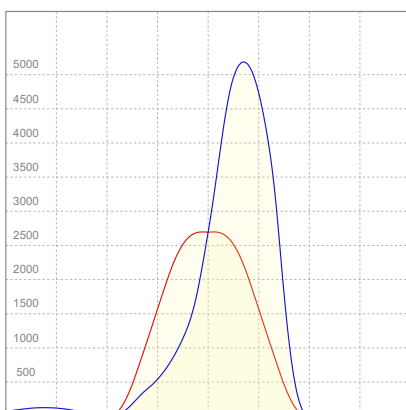

## ELECTRICAL SPECIFICATIONS

Input voltage	Input current	Input power	Effeciency
226V	1,02A	218,8W	43lm/W

## ISO CANDELA DIAGRAM

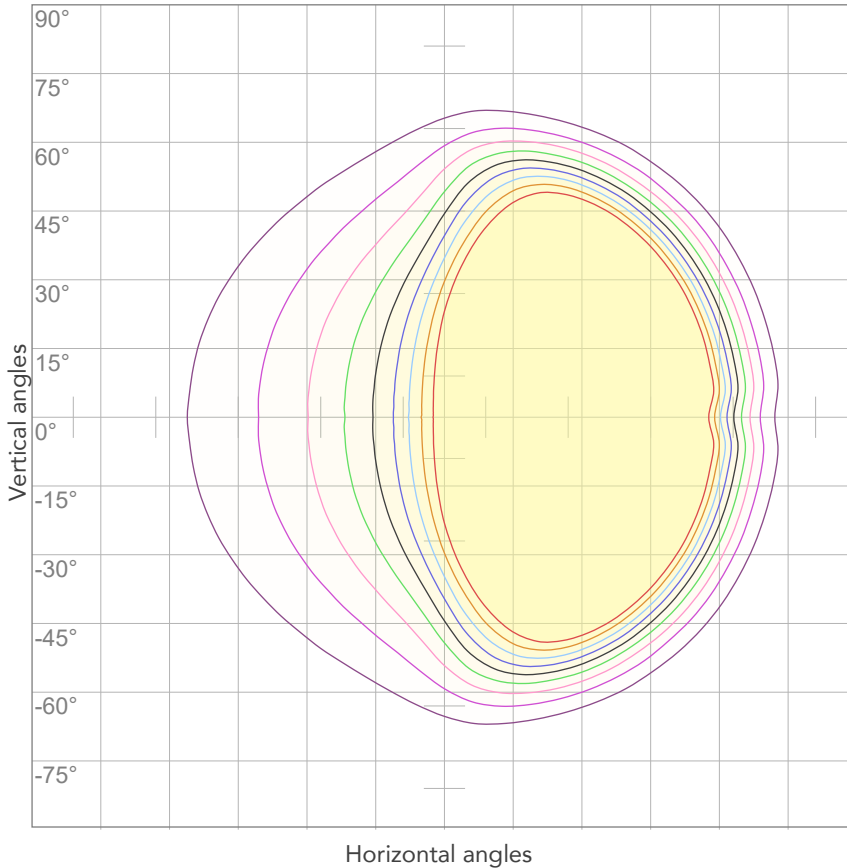

10%	269 cd
20%	539 cd
30%	808 cd
40%	1078 cd
50%	1347 cd
60%	1616 cd
70%	1886 cd
80%	2155 cd

Conditions:

Number of c-planes: 64

Candela at center: 2694 cd

## ISO LUX DIAGRAM

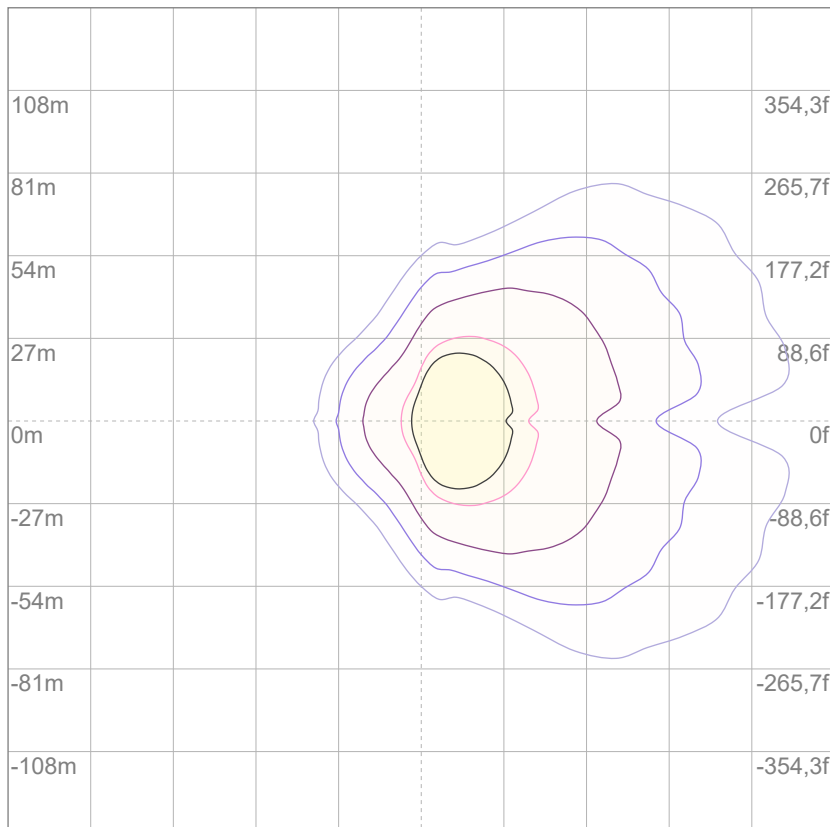

3%	0,808 lx
5%	1,35 lx
10%	2,69 lx
30%	8,08 lx
50%	13,5 lx

Conditions:

Number of c-planes: 64

Lux at center: 26,9 lx

*Lux distribution on a surface when lamp is mounted at 10 meters from the surface.*

Mounting height: 10 meters (33 feet)