

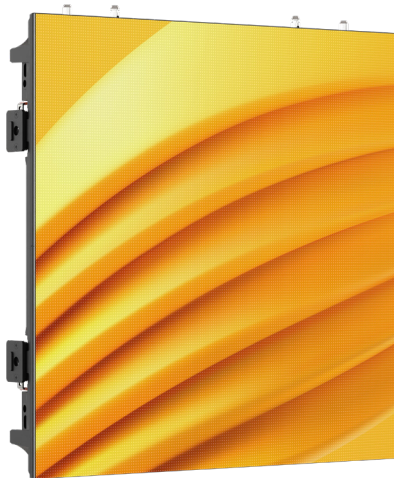

GAMMAPIX 29B1X1BF

Indoor LED wall module, SMD1515 BF,
p.2,97mm, 50x50cm, 168x168pix, 650 nit,
5,9kg



USER MANUAL

Thank you for choosing PROLIGHTS

Please note that every PROLIGHTS product has been designed in Italy to meet quality and performance requirements for professionals and designed and manufactured for the use and application as shown in this document.

Any other use, if not expressly indicated, could compromise the good condition/operation of the product and/or be a source of danger.

This product is meant for professional use. Therefore, commercial use of this equipment is subject to the respectively applicable national accident prevention rules and regulations.

Features, specifications and appearance are subject to change without notice. Music & Lights S.r.l. and all affiliated companies disclaim liability for any injury, damage, direct or indirect loss, consequential or economic loss or any other loss occasioned by the use of, inability to use or reliance on the information contained in this document.

Product user manual can be downloaded from the website www.prolights.it, or can be inquired to the official PROLIGHTS distributors of your territory (https://www.prolights.it/sales_network.html).

Scanning the below **QR Code**, you will access the download area of the product page, where you can find a broad set of always updated technical documentation: specifications, user manual, technical drawings, photometrics, personalities, fixture firmware updates.



**Visit the download area
of the product page**



The PROLIGHTS Logo, PROLIGHTS names and all other trademark in this document pertaining to PROLIGHTS services or PROLIGHTS product are trademarks OWNED or licensed by Music & Lights S.r.l., its affiliates, and subsidiaries. PROLIGHTS is a registered trademark by Music & Lights S.r.l. All right reserved. Music & Lights – Via A. Olivetti, snc - 04026 - Minturno (LT) ITALY.

INDEX

SAFETY INFORMATION	02
1 - OPTIONAL ACCESSORIES	4
2 - TECHNICAL DRAWING	4
3 - PRODUCT OVERVIEW	5
4 - INSTALLATION	6
GROUND BAR STACKING SYSTEM	6
FLY BAR HANGING SYSTEM.....	11
5 - CONNECTION TO THE MAINS SUPPLY	15
6 - START UP	15
CONNECT AND DISCONNECT POWER FROM THE PRODUCT.....	15
7 - DATA CONNECTION	16
DATA CABLING	16
MAIN AND BACKUP DATA LINE.....	16
8 - LED DISPLAY CONTROL SETTING	18
SYSTEM CONFIGURATION.....	18
RESOLUTION MANAGEMENT	19
LED SCREEN CONFIGURATION WITH NOVALCT	20
APPLICATION EXAMPLE.....	22
9 - MAINTENANCE	25
MAINTENANCE AND CLEANING THE PRODUCT.....	25
MAINTENANCE ON INDOOR PRODUCT	25
MAINTENANCE ON OUTDOOR PRODUCT	26
CORRECT STARTUP/SHUTDOWN SEQUENCE.....	26
TRANSPORTATION AND STORAGE.....	26
GENERAL INDICATIONS FOR USE.....	27
TROUBLESHOOTING.....	28

SAFETY INFORMATION



WARNING!

- See <https://www.prolights.it/product/GAMMAX29B1X1BF#download> for installation instructions.
- Please read carefully the instruction reported in this section before installing, powering, operating or servicing the product and observe the indications also for its future handling.



This unit is not for household and residential use, only professional applications.



Connection to mains supply

- The Connection to the mains supply must be carried out by a qualified electrical installer.
- Use only AC supplies 100-240V 50-60 Hz, the fixture must be electrically connected to ground (earth).
- Select the cable cross section in according with the maximum current draw of the product and the possible number of products connected at the same power line.
- The AC mains power distribution circuit must be equipped with magnetic+residual current circuit breaker protection.
- Do not connect it to a dimmer system; doing so may damage the product.



Protection and Warning against electrical shock

- Do not remove any cover from the product, always disconnect the product from AC power before servicing.
- Ensure that the fixture is electrically connected to ground (earth). And use only a source of AC power that complies with local building and electrical codes and has both overload and ground-fault (earth-fault) protection.
- Before using the fixture, check that all power distribution equipment and cables are in perfect condition and rated for the current requirements of all connected devices.
- Isolate the fixture from power immediately if the power plug or any seal, cover, cable, or other components are damaged, defective, deformed or showing signs of overheating.
- Do not reapply power until repairs have been completed.
- Refer any service operation not described in this manual to PROLIGHTS Service team or an authorized PROLIGHTS service center.



Installation

- Make sure that all visible parts of the product are in good visible condition before its use or installation.
- Make sure the point of anchorage is stable before positioning the projector.
- When suspending the fixture above ground level, secure it against failure of primary attachments by attaching a safety cable that is approved as a safety attachment for the weight of the fixture to the attachment point on the main frame of the product. In case the safety cable, enter in action, it needs to be replaced with a new one.
- Install the product only in well ventilated places.
- For non temporary installations, ensure that the fixture is securely fastened to a load-bearing surface with suitable corrosionresistant hardware.
- For a temporary installation with clamps, ensure that the quarter-turn fastener and/or screws are turned fully, and secured with a suitable safety cable.



Protection from burns and fire

- The exterior of the fixture becomes hot during use. Avoid contact by persons and materials.
- Ensure that there is free and unobstructed airflow around the fixture.
- Keep flammable materials well away from the fixture.
- Do not expose the front glass to sunlight or any other strong light source from any angle. Lenses can focus the sun's rays inside the fixture, creating a potential fire hazard.
- Do not attempt to bypass thermostatic switches or fuses.



Indoor use

- This product is designed for indoor and dry environments.
- Do not use in wet location and do not expose the fixture to rain or moisture.
- Never use the fixture in places subject to vibrations or bumps.
- Make certain that no inflammable liquids, water or metal objects enter the fixture.
- Excessive dust, smoke fluid, and particle build up degrades performance, causes overheating and will damage the fixture.
- Damages caused by inadequate cleaning or maintenance are not covered by the product warranty.



Maintenance

- Warning! Disconnect the fixture from AC mains power and allow to cool for at least 10 minutes before handling.
- Only technicians who are authorized by PROLIGHTS or Authorised service partners are permitted to open the fixture.
- Users may carry out external cleaning, following the warnings and instructions provided, but any service operation not described in this manual must be referred to a qualified service technician.
- Important! Excessive dust, smoke fluid, and particle build up degrades performance, causes overheating and will damage the fixture. Damages caused by inadequate cleaning or maintenance is not covered by the product warranty.



Disposal

- This product is supplied in compliance with European Directive 2012/19/EU – Waste Electrical and Electronic Equipment (WEEE). To preserve the environment please dispose/ recycle this product at the end of its life according to the local regulation.



The products to which this manual refers comply with:

- 2014/35/EU - Safety of electrical equipment supplied at low voltage (LVD).
- 2014/30/EU - Electromagnetic Compatibility (EMC).
- 2011/65/EU - Restriction of the use of certain hazardous substances (RoHS).



Other approvals



1 - OPTIONAL ACCESSORIES

- GXFCM100291X1 Flightcase 10 in1 per GAMMAX29B1X1BF
- GXHGB01 Fly bar / ground bar per sistemi GAMMAX29B e GAMMAX48T, 1 colonna
- GXHGB02 Fly bar / ground bar per sistemi GAMMAX29B e GAMMAX48T, 2 colonne
- DXBS21 Supporto posteriore 2in1 per moduli DELTAX e GAMMAX series per montaggio a terra
- DXBS31 Supporto posteriore 3in1 per moduli DELTAX e GAMMAX series per montaggio a terra
- DXBS41 Supporto posteriore 4in1 per moduli DELTAX e GAMMAX series per montaggio a terra
- DXBSC Piastra posteriore per moduli DELTAX e GAMMAX series per il montaggio a terra
- DXXJ Giunto metallico per unire 4 cabinet serie DELTAX e GAMMAX, foro M10 per gancio
- GXCJ Piastra curvabile per cabinets ledwall GAMMAX series
- OXFCIS100 Flightcase per strutture rigging/ground-stack OMEGAX-DELTAX series, 100cm
- OXFCIS200 Flightcase per strutture rigging/ground-stack OMEGAX-DELTAX series, 200cm
- OXFCSP Flightcase per parti di ricambio per moduli LED-display OMEGAX-DELTAX series
- OXACL01 Cavo di alimentazione per led display series, L.140 cm
- OXACL10 Cavo di alimentazione per led display series L.10 m
- SXDCL01 Cavo dati per SIGMAX LED display series assemb. con RJ45, L 140 cm
- SXDCL10 Cavo dati per SIGMAX LED display series assemb. con RJ45, L 10 m
- FMTOOL Strumento per la manutenzione frontale dello schermo OMEGAX-DELTAX LED (INDOOR)
- LMRT00L Strumento per la sostituzione delle maschere frontali per OMEGA26B

2 - TECHNICAL DRAWING

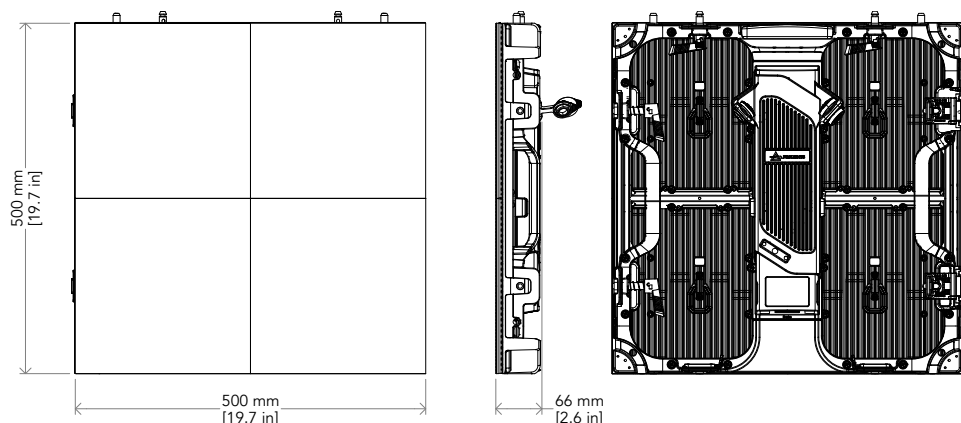

Weight: 5,9 kg - 13,01 lbs

Fig. 01

3 - PRODUCT OVERVIEW

1. MODULE: single LED display module that makes up the cabinet with magnetic attachment
2. SIDE LOCK MECHANICS: Side Panel locking and unlocking mechanism.
3. UPPER LOCK MECHANICS: Upper Panel locking and unlocking mechanism.
4. POWER IN CONNECTOR: for connection to the Mains 100-240V~/50-60Hz.
5. POWER OUT CONNECTOR: power output for connection of multiple units in series.
6. POSITIONING PIN: allows to center and hook cabinet easier.
7. CORNER PROTECTION
8. ANGLE MECHANICS: allow both concave and convex precise installation of $+10^\circ / -10^\circ$.
9. MOUNTING HOLE: to be used to fix the cabinets together using a metal plate.
10. LOCKING TAB: to hook cabinet to underside.
11. SIGNAL CONNECTORS: Ethernet connectors for sending and receiving Data Information from the controller.
12. CABLE LOCK: block to secure DATA and Power cables
13. CABINET HANDLE: handy handles for easy assembly.

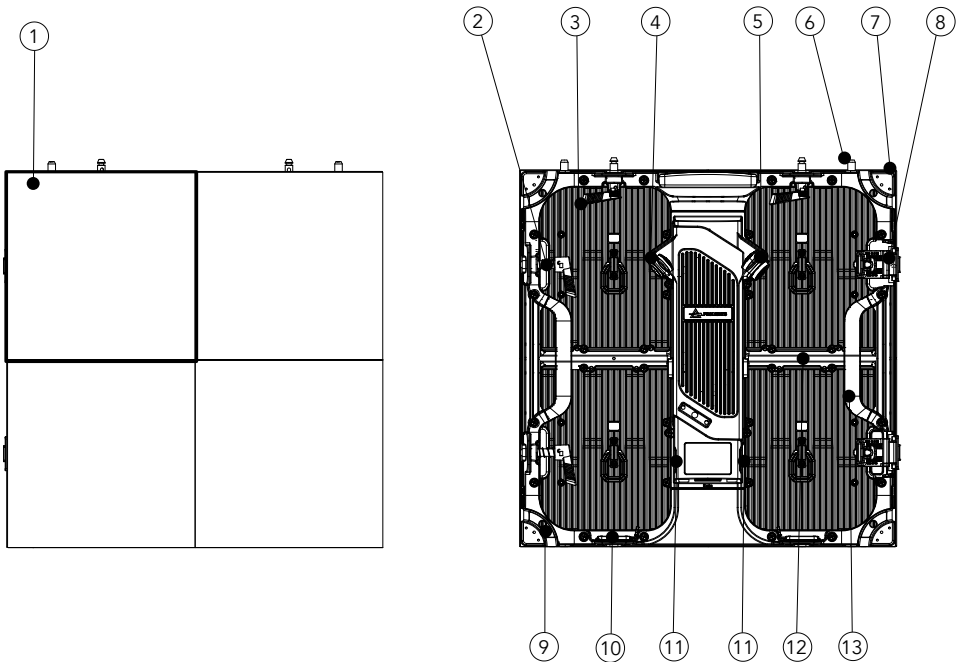
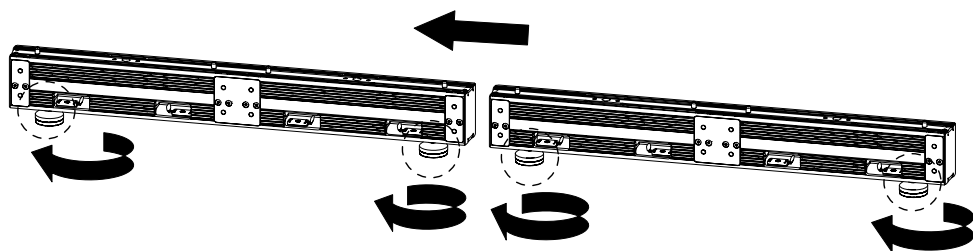

Fig 02

4 - INSTALLATION

GROUND BAR STACKING SYSTEM



Align the ground beam GXHGB01 / GXHGB02, then adjust the height of the ground foot to keep the ground beam horizontally.

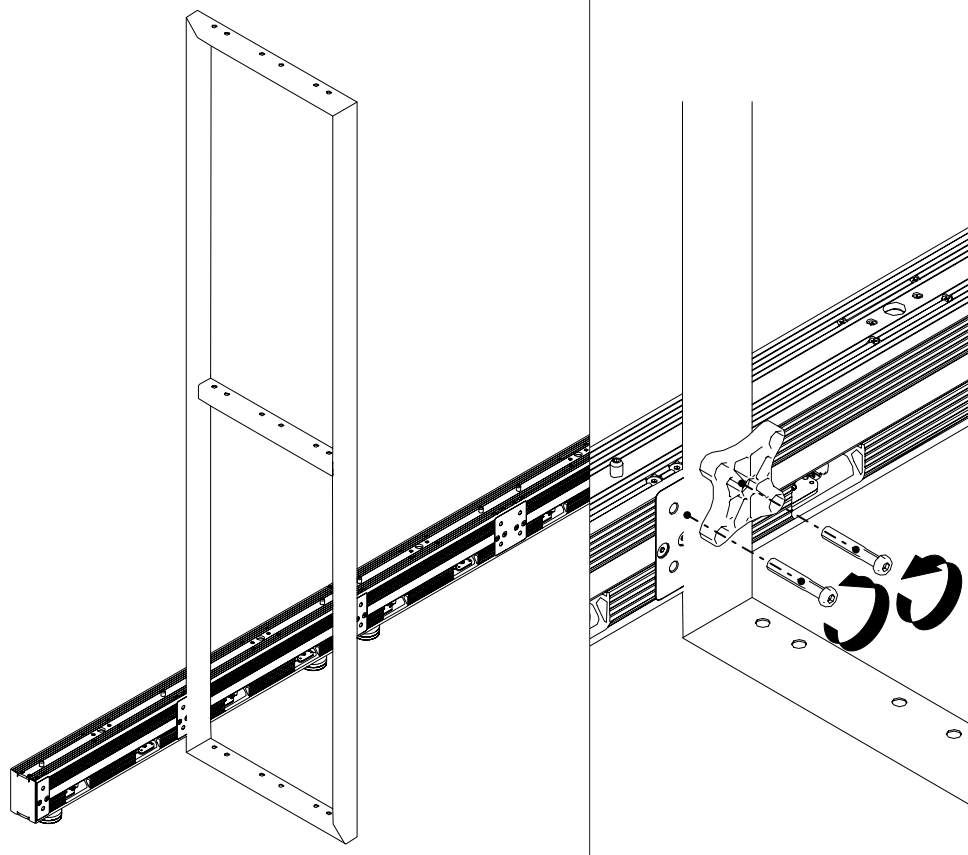

Screw the two down bolts of the DXBS21 to the ground beam GXHGB01 / GXHGB02 through the back frame DXBSC.

Fig 03

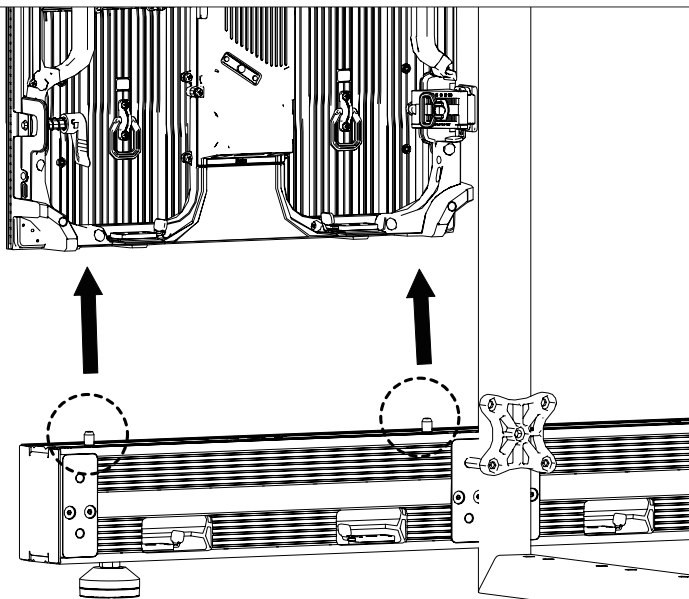

Install the cabinet.

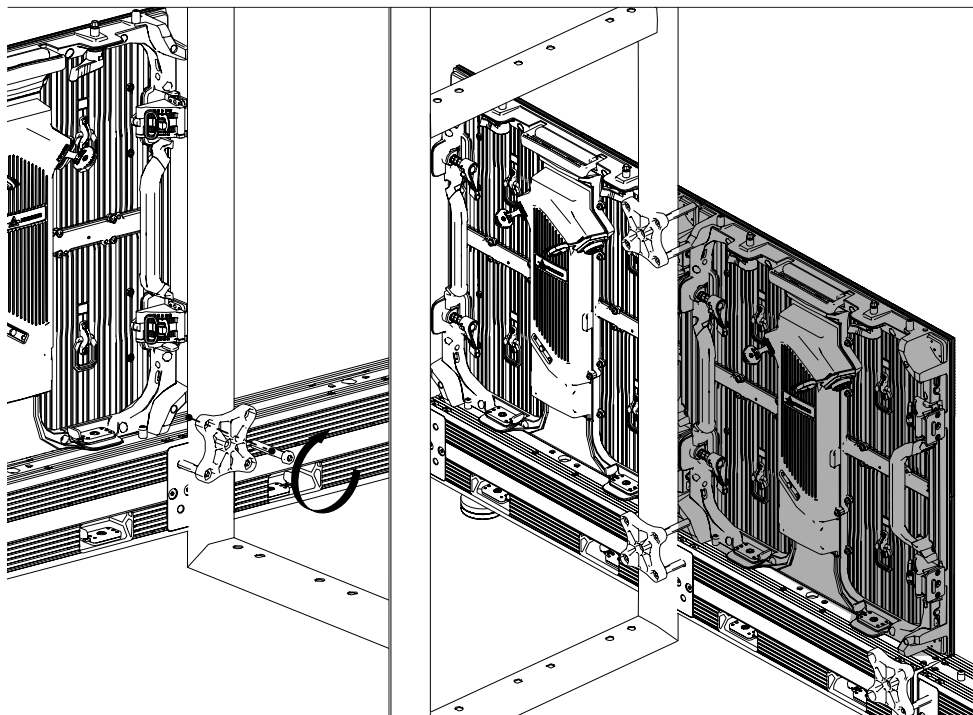

Screw the two top bolts of the DXBS21 to the cabinet.

Fig 04

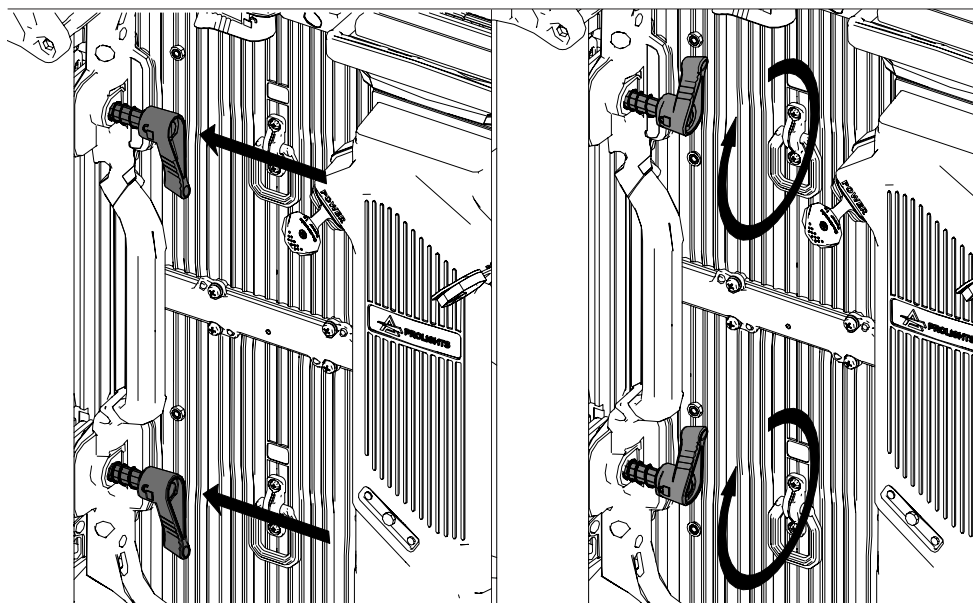

To mount the cabinets horizontally, use the specific side locks by push and turning the locking lever.

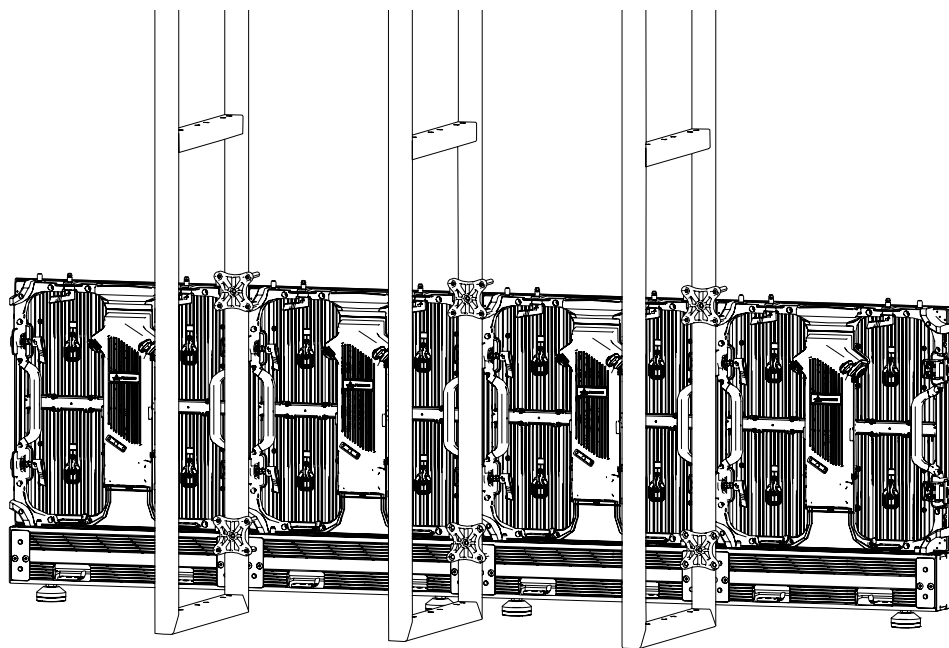

Complete the line for then assemble the next line.

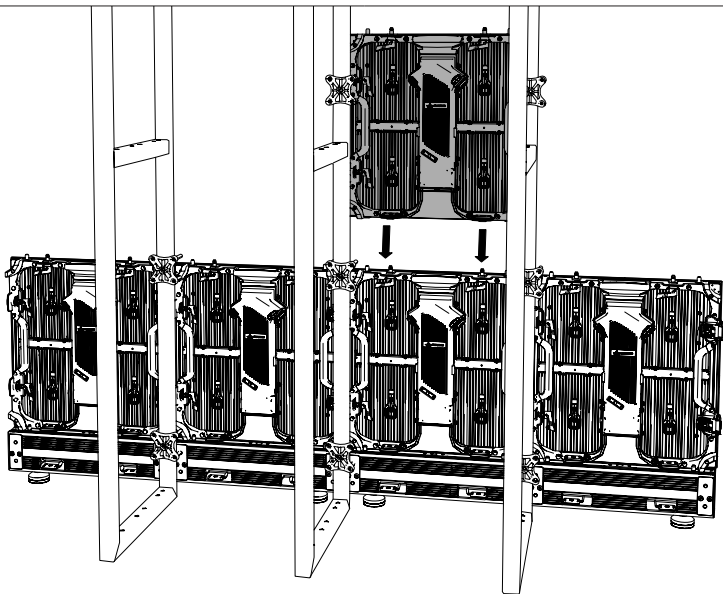

To mount the cabinets vertically, match the pins of the cabinet below with the holes of the cabinet you are mounting.

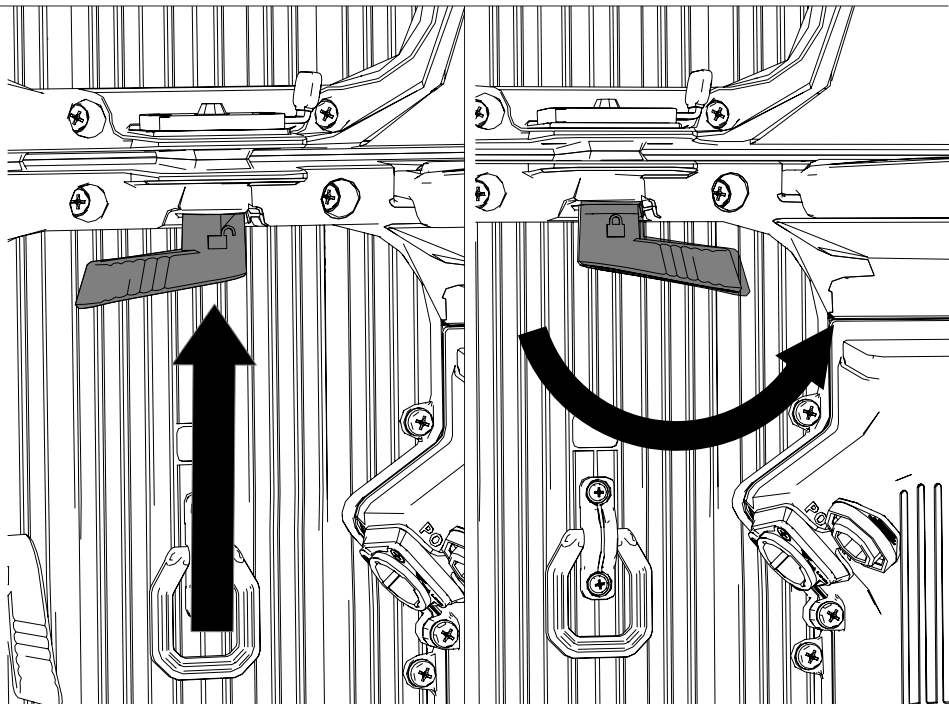

To lock the cabinets vertically, use the upward lock by push and turning the locking lever.

Fig 06

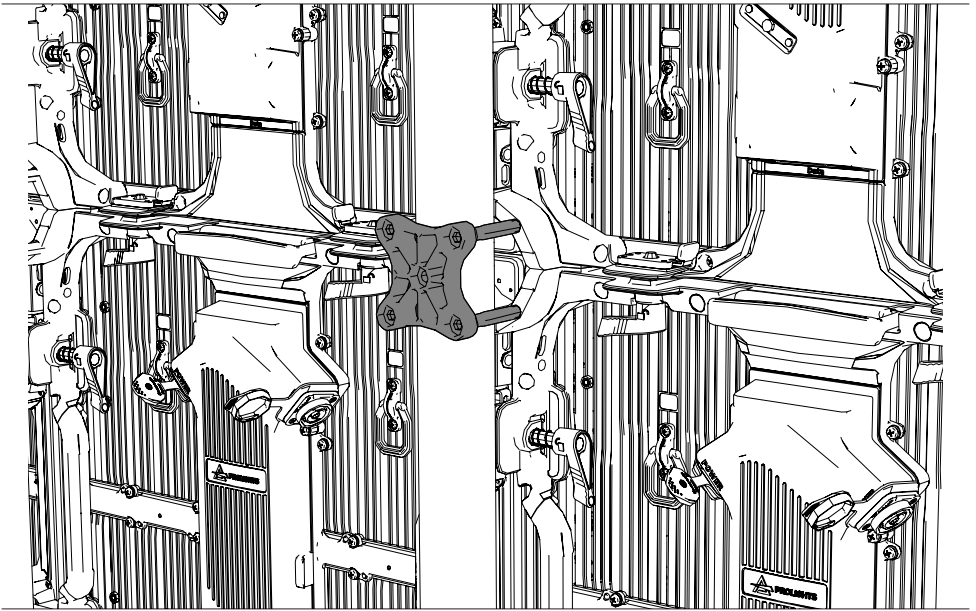

Install the DXBSC back plate between cabinets in case of complex installations.

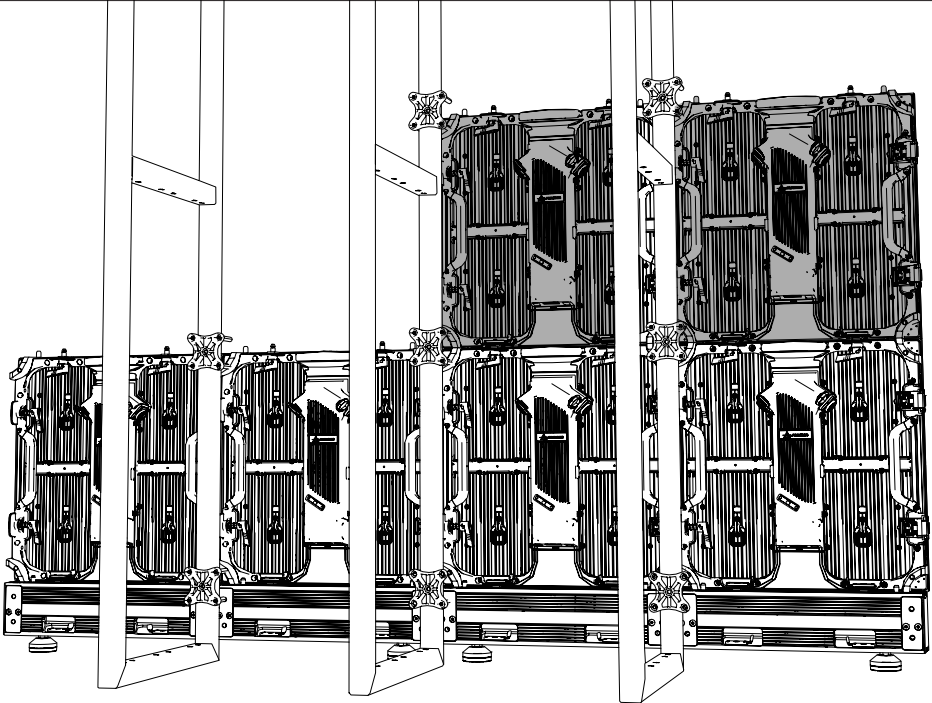

Finally, repeat all the previous steps to complete the Video Wall.

Fig 07

FLY BAR HANGING SYSTEM

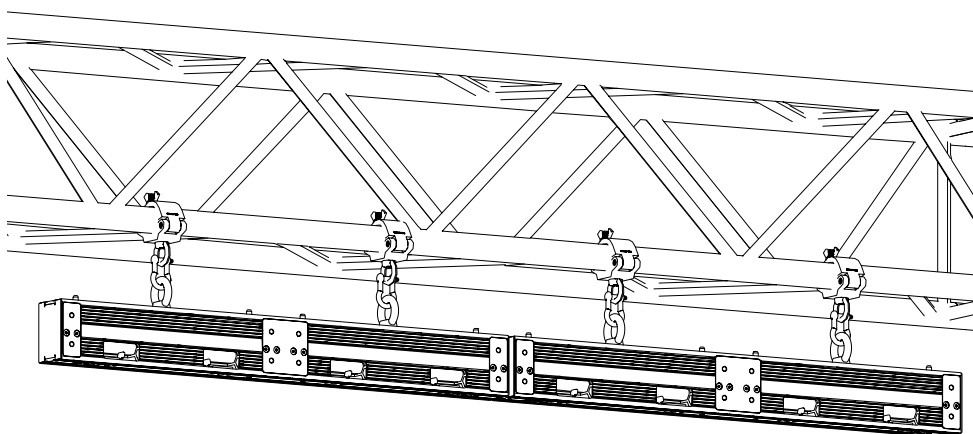

Fasten the fly GXHGB01 / GXHGB02 fly bars at the structure.

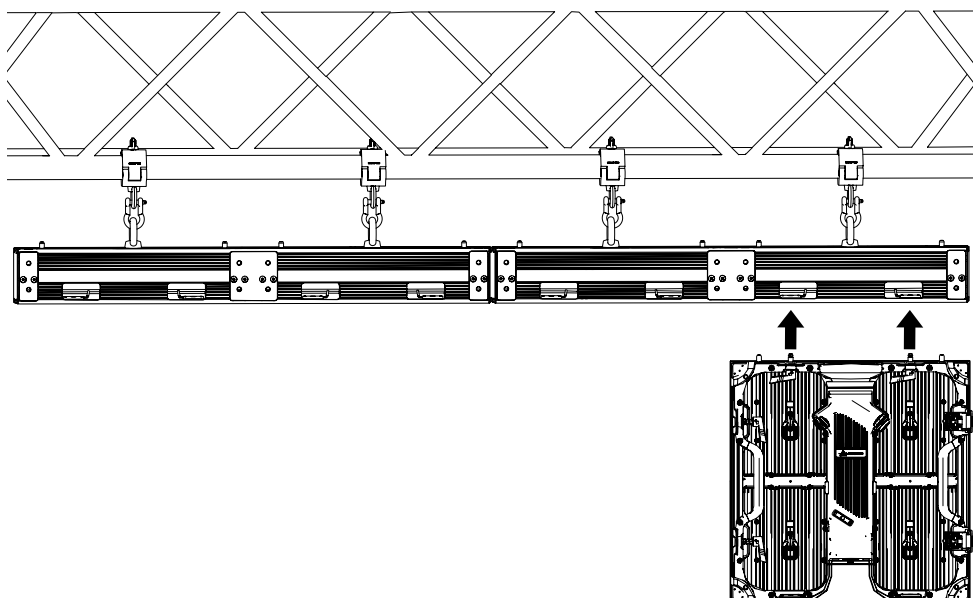

Install the cabinet on the flybars by matching the pins to the holes in the bars.

Fig 08

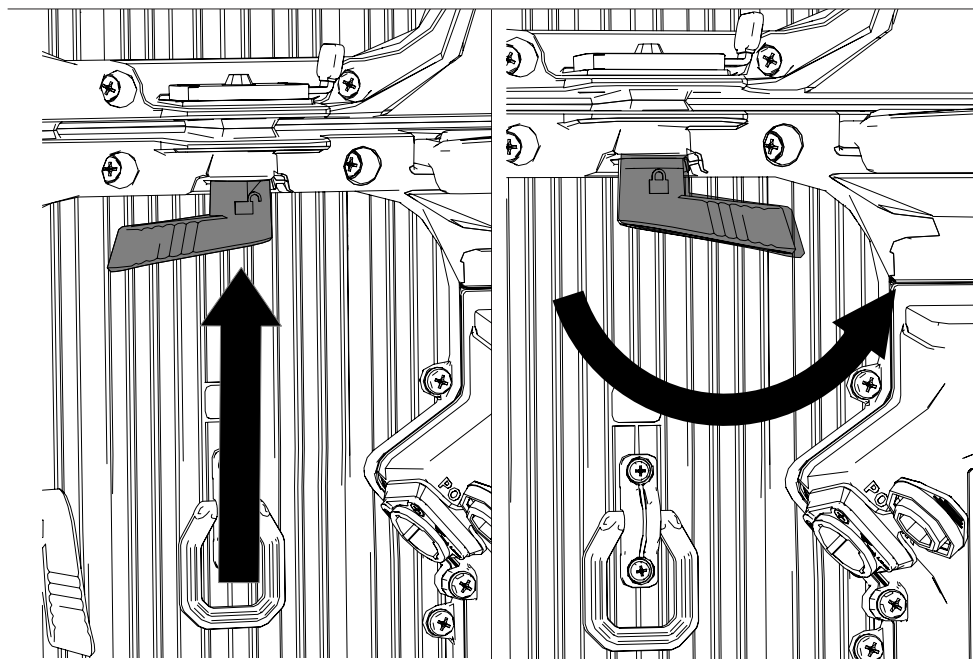

To lock the cabinets vertically, use the upward lock by push and turning the locking lever.

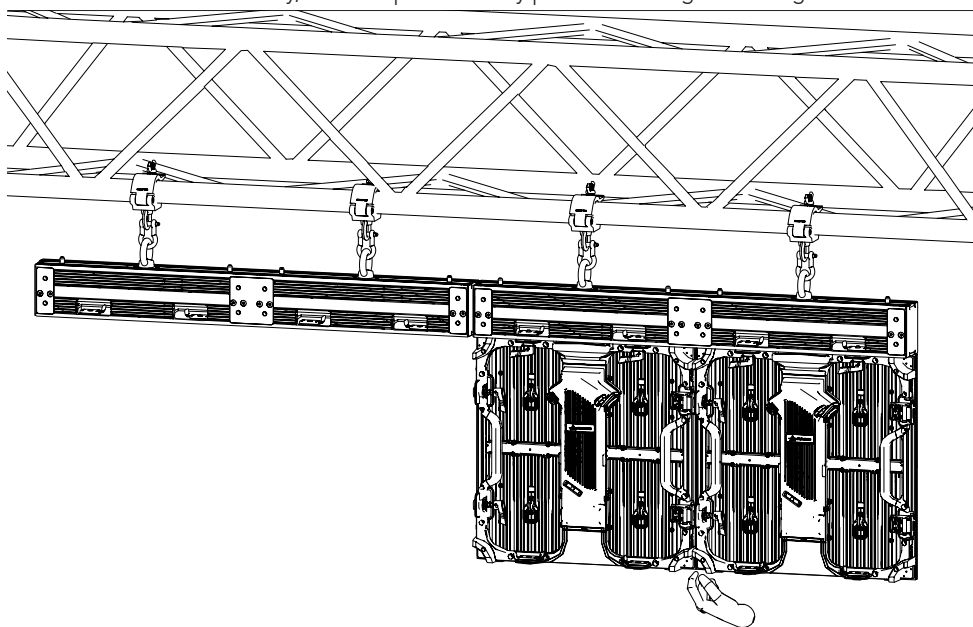

Pay attention that the cabinets are well aligned and make sure there are no steps between panels horizontally and on the front of the panels.

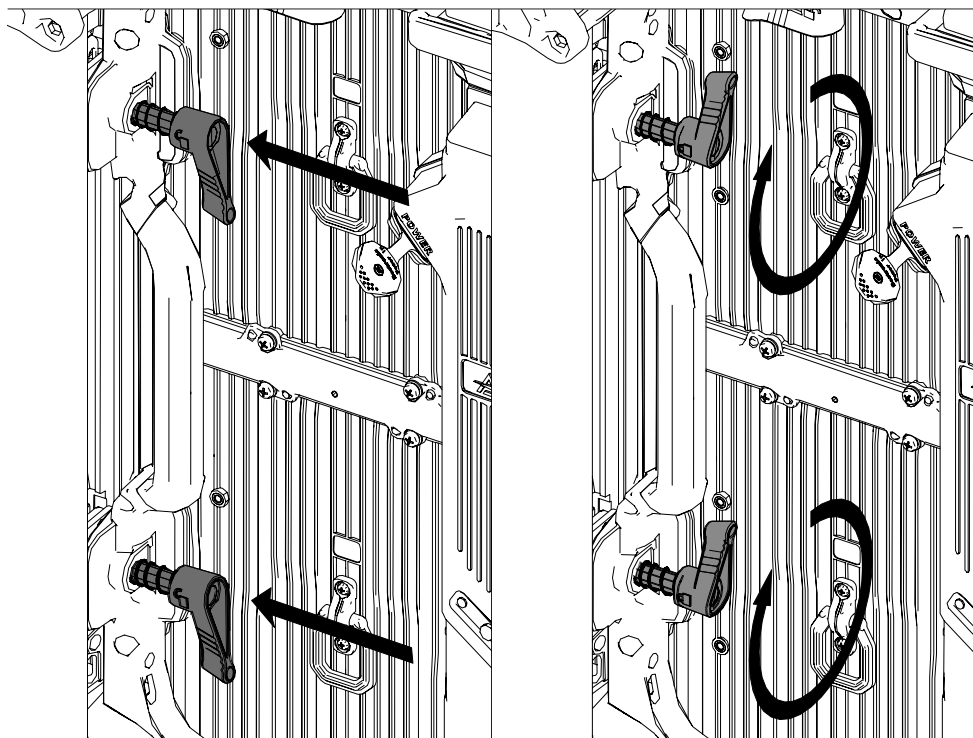

Use the specific side locks by push and turning the locking lever, to hook the cabinets horizontally

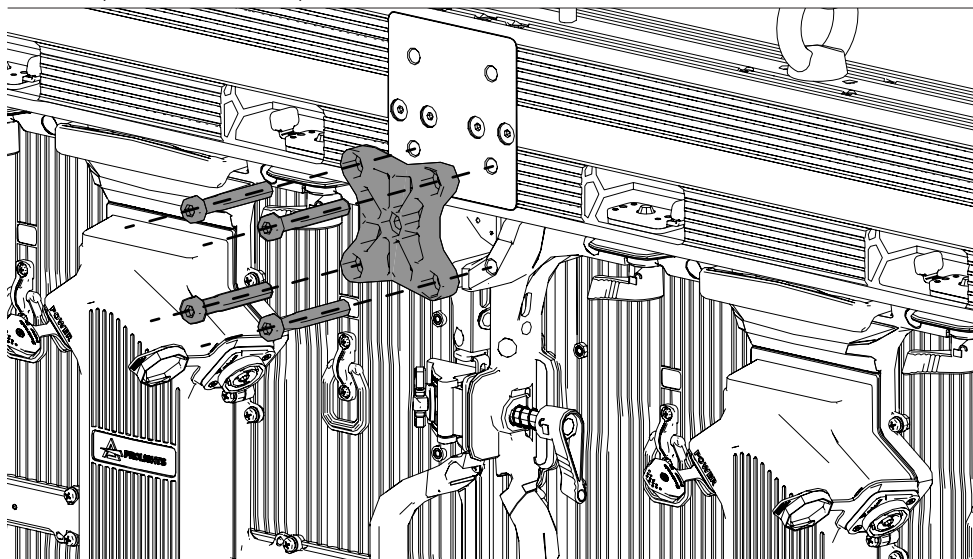

Install the DXXJ back plate between cabinets and Flybar.

Fig 10

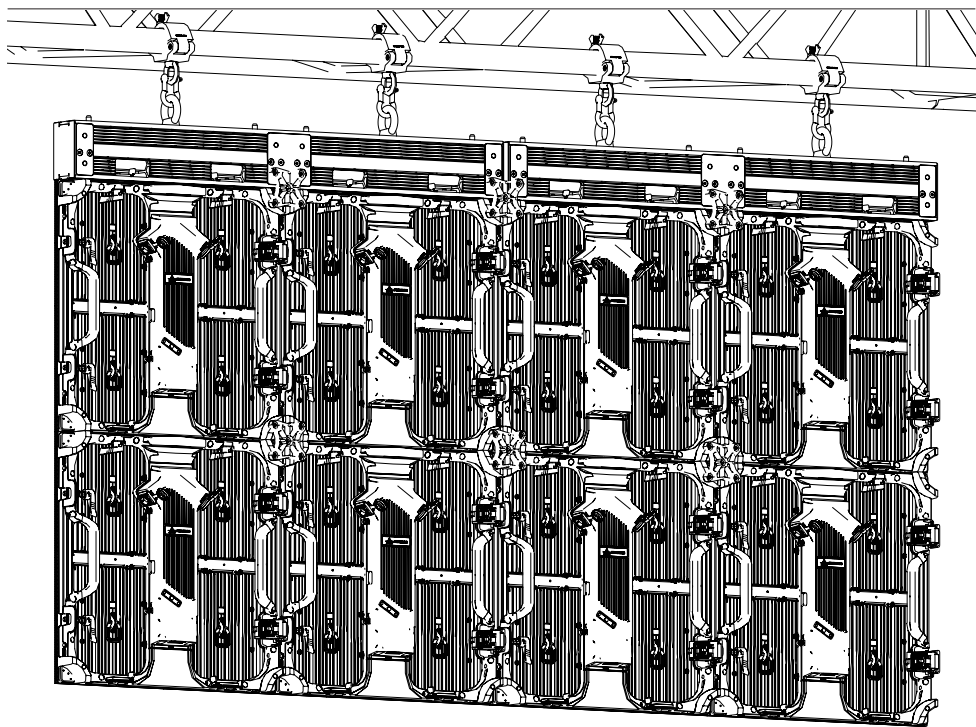

Finally, fasten other cabinets sequentially from top to bottom and from middle to both sides (the number of cabinets in vertical direction shall not be more than 10 cabinets, while in the horizontal direction is not restricted)

Fig 11

5 - CONNECTION TO THE MAINS SUPPLY

Each cabinet has an IN and OUT power connection (powercon true or powercon). It's possible to connect in chain many cabinets. To design the power cabling, it's necessary to know the max power consumption for each panel. It's possible to see this info in the specifications of the product
Examples:

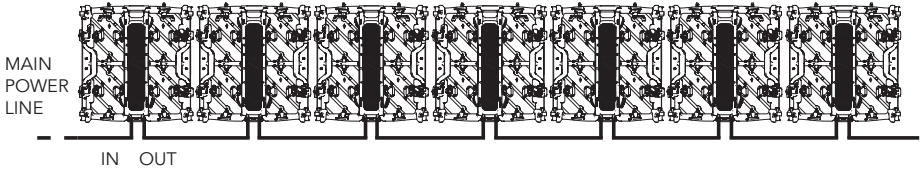

Fig. 12

WARNING: For protection from electric shock, the panel must be earthed!

The product is equipped with auto-switching power supply that automatically adjusts to any 50-60Hz AC power source from 110-230 Volts.

If you need to install a power plug on the power cable to allow connection to power outlets, install a grounding-type (earthed) plug, following the plug manufacturer's instructions. If you have any doubts about proper installation, consult a qualified electrician.

The maximum power consumption of single panel is 120W.

Core (EU)	Core (US)	Connection	Plug terminal marking
Brown	Black	Live	L
Blue	White	Neutral	N
Yellow+green	Green	Earth	

NOTE: it's suggested to use a class D switch.

6 - START UP

CONNECT AND DISCONNECT POWER FROM THE PRODUCT

To apply and disconnect power to the product:

- Check that the product is installed and secured as indicated in the Safety Informations, and that personal safety will not be put at risk when the fixture lights up.
- Connect the power connector into the Mains input socket (100-240 VAC-50/60 Hz).
- The product is then ready for its operations and can be controlled through the available input signals on board.
- To disconnect power from the product, disconnect the Mains from the socket.

7 - DATA CONNECTION

DATA CABLING

Each cabinet has an IN and OUT data connection (RJ45). Each data output of a Novastar processor, can manage a max of 650.000 pixels. To design the cabling of data, it's necessary to know the resolution of each cabinet.

Examples:

Product	Cabinet Total Pixels	Max number of cabinets for a data line
SIGMA X26 series	(192x192 pixels) 36.864	17
GAMMA X29 series	(168x168 pixels) 28.224	23
SIGMA X39 series X1	(128x128 pixels) 16.384	39
SIGMA X39 series X2	(128x256 pixels) 32.768	19
GAMMA X48 series X1	(104x104 pixels) 10.816	60
GAMMA X48 series X2	(104x208 pixels) 21.632	30
KAPPA X26 series	(192x192 pixels) 36.864	17

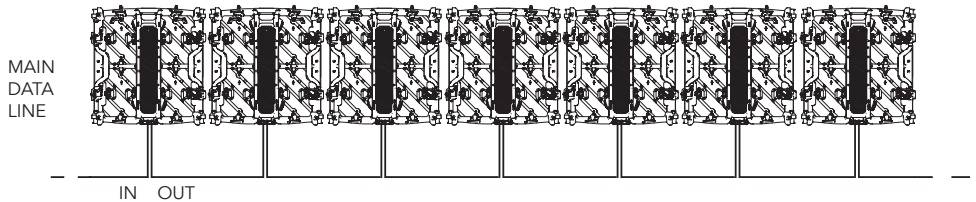

Fig. 13

NOTE: it's suggested to distribute the signal as evenly as possible between the various signal lines.

NOTE: it's necessary to complete a row or a column with a data chain. It's not possible to connect half of a row or a column on a data chain.

MAIN AND BACKUP DATA LINE

For all Prolights led screen cabinet it's possible to install a MAIN data line and a BACKUP data line. This allows to see image on led screen in case of MAIN failure. MAIN and BACKUP need to be assigned from the PC software to the outputs of the processor.

MAIN data cable comes from the output of the processor to the last cabinet of the chain.

BACKUP data cable come from the output of the last cabinet of the chain to the output of the processor.

NOTE: it's always suggested to use different processor for MAIN line and BACKUP line

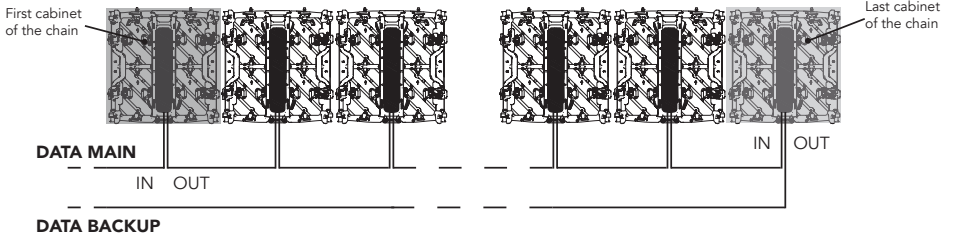

Fig. 14

8 - LED DISPLAY CONTROL SETTING

SYSTEM CONFIGURATION

Novastar processor is the sending card that sends signal to cabinets. Each cabinet has a receiving card mounted in. Novastar processor has a different number of DATA output depending from the product version. Each DATA output can manage a max number of 650.000 pixels.

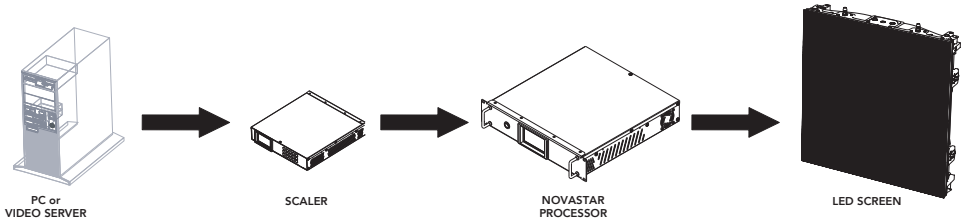

Fig. 15

NOTE: 650.000 it's only a reference number considered for a settings of 60Hz and 8 bit for color. The max number of pixels is related to different values such as bit rate, cables quality and cables length.

The type and the number of Novastar processor need to be selected in relation to:

- total led screen dimensions
- total led screen resolution
- kind of application (fixed or rental)
- scaling needed or not
- input video source

Equipment in need to configure the led screen:

- Windows PC
- USB cable
- Nova LCT software

NOTE: PRO user can utilize the software SMARTLCT to configure more complex led screen. It's possible to see user manual on Novastar web site download page <https://www.novastar.tech/downloads/>

RESOLUTION MANAGEMENT

The have the best result in terms of resolution on your led screen is to respect the chain of input and output resolution between video source and led screen.
The more the rate between led screen pixels and sending card resolution is near to 1:1, the more the result is better.

Video resolution need to be defined during led screen design

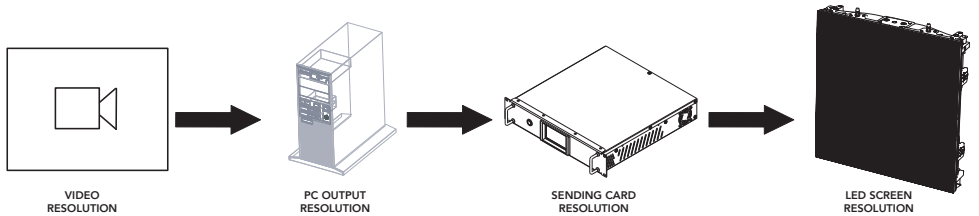

Fig. 16

PC output resolution can be set in PC settings

Led screen resolution is the phisical number of pixels in the led screen as shown at **page 3**

Sending card resolution can be set on NOVALCT in **Screen Configuration - Sending Card**

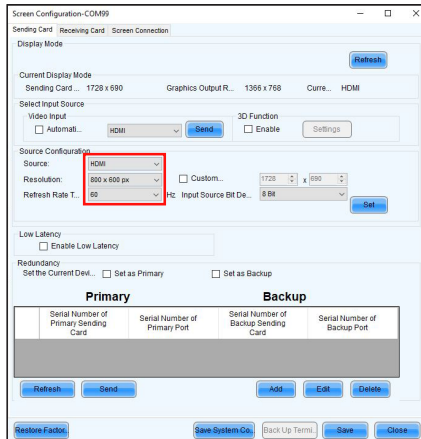

Fig. 17

Example:

Product	SIGMA X26 series
Led screen dimension	10 columns X 5 rows
Led screen resolution	1.843.200 pixels
Video Resolution	HD 1920x1080 (2.073.600 pixels)
Pc output resolution	NOTE: HD resolution can be used in this case because is very similar to the native one
Sending card resolution	
Pixel rate	1:1,125 (2.073.600/1.843.200)

LED SCREEN CONFIGURATION WITH NOVALCT

1 Open the software Nova LCT.
Login as Advancer User with Admin password.

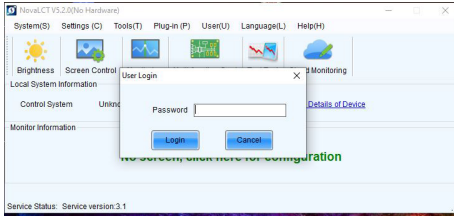

2 Go in Screen Configuration and Next

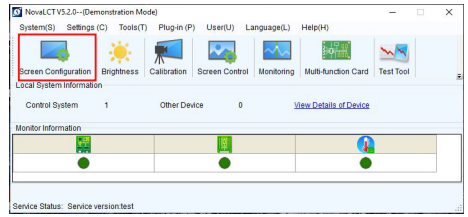

3 Go in Screen Connection tab

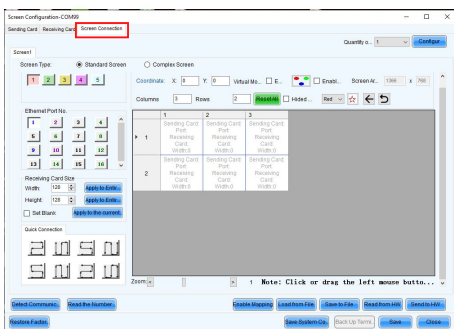

4 Set the quantity of screen and Configure

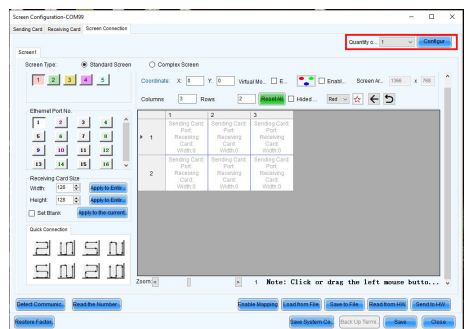

5 Set the number of columns and rows

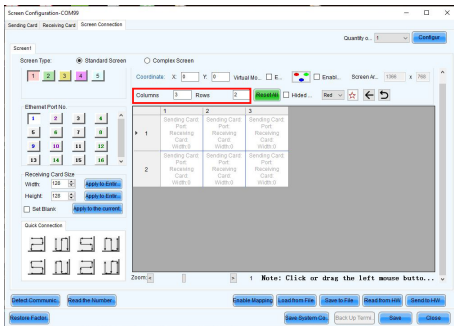

6 Set the cabinet resolution and apply to entire row and column

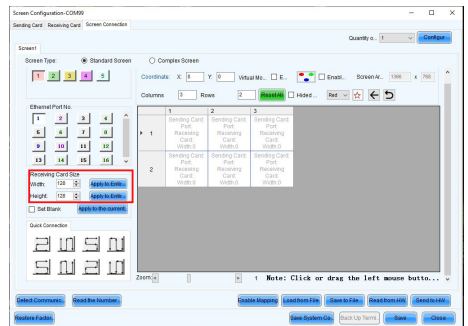
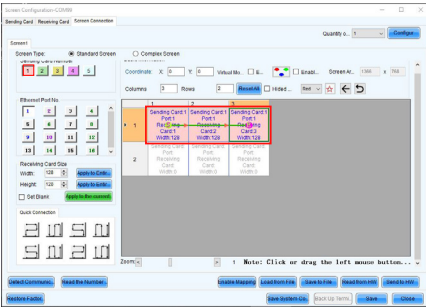
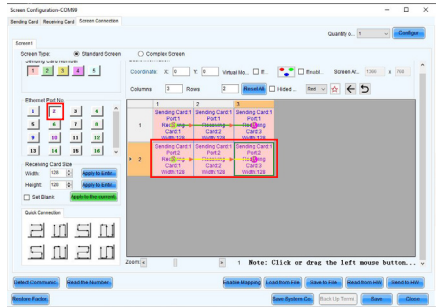

Fig. 18

7 Select the port of the processor and draw the data line on the screen (view from behind)



8 Repeat the same procedure with another port and other cabinets (if needed)



9 Once completed all data lines click on Send to HW and Save

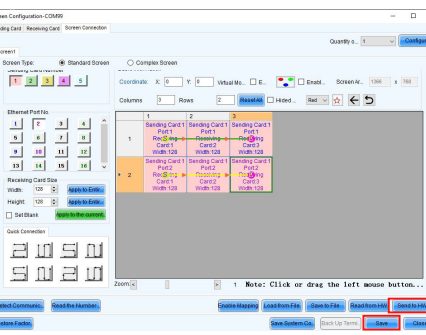

10 Go in Sending Card and click Add

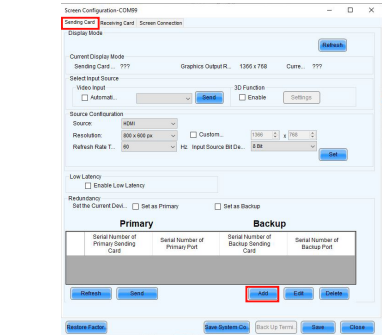

11 Set the Backup and press Add

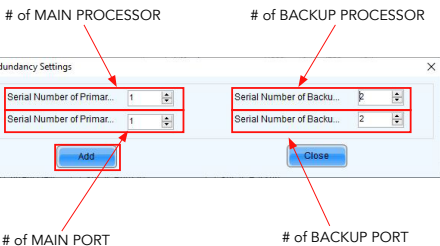

12 Press Send to apply settings and Save

Primary		Backup	
Serial Number of Primary Sending Card	Serial Number of Primary Port	Serial Number of Backup Sending Card	Serial Number of Backup Port
1	1	1	2

Buttons: Refresh, Send, Add, Edit, Delete

Fig. 19

APPLICATION EXAMPLE

Design a LED screen:

Product	SIGMA X26 series	
Led screen dimension	45 cabinets	9 columns X 5 rows
Led screen resolution	1.658.880 pixels	192x192x45
Novastar processor	2NOVAMCTRL660	1 MAIN + 1 BACKUP
Output number	8	4 for each processor
Pixels Capacity	2.300.000 pixels for each processor	
Video Resolution	1720 x 960 pixels	
Pc output resolution		
Sending card resolution		
Pixel rate	1:1	

Processor's port assignment:

PROCESSOR 1 MAIN

Output 1	Output 2	Output 3	Output 4
MAIN 1	MAIN 2	MAIN 3	not used
row 1	row 3	row 5	
row 2	row 4		
10 cabinets	10 cabinets	5 cabinets	

PROCESSOR 2 BACKUP

Output 1	Output 2	Output 3	Output 4
MAIN 1	MAIN 2	MAIN 3	not used
row 1	row 3	row 5	
row 2	row 4		
10 cabinets	10 cabinets	5 cabinets	

Power line distribution:

16A LINE 1	16A LINE 2	16A LINE 3
Column 1	Column 4	Column 7
Column 2	Column 5	Column 8
Column 3	Column 6	Column 9
15 cabinets	15 cabinets	15 cabinets

Data line schematics:

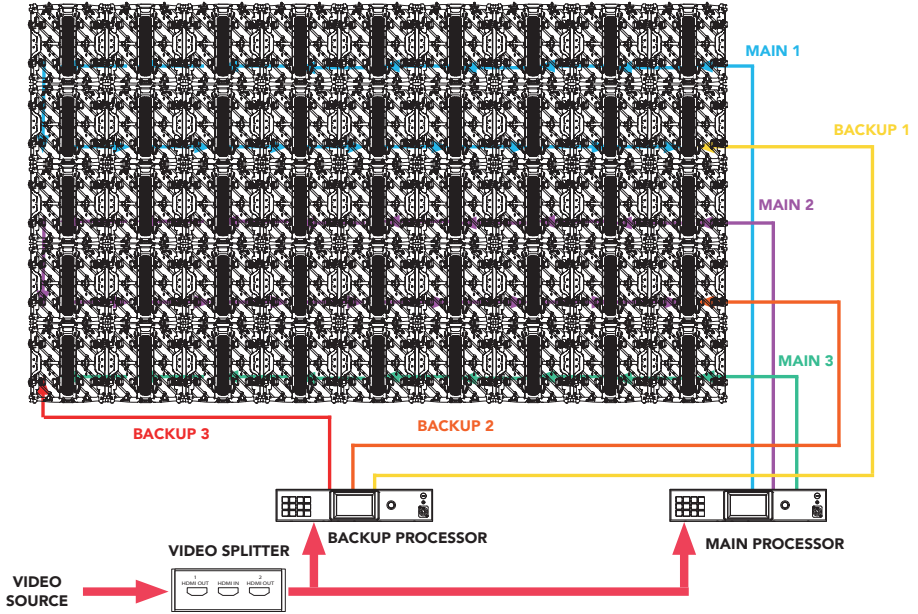

Fig. 20

Power line schematics:

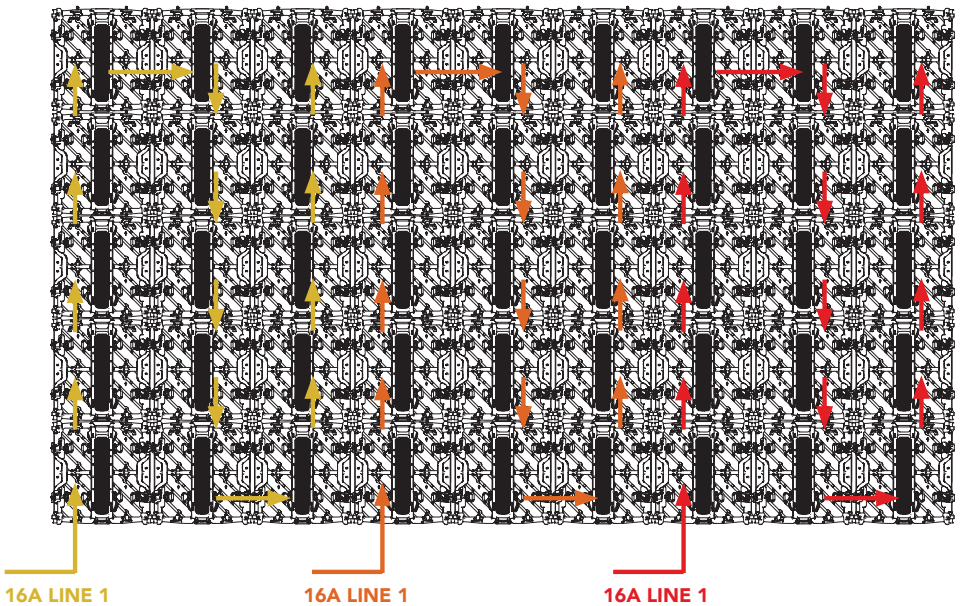
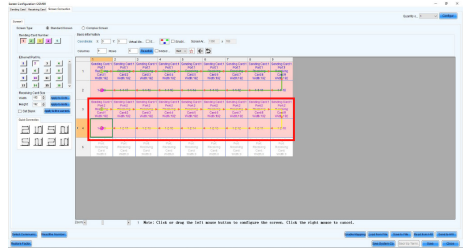
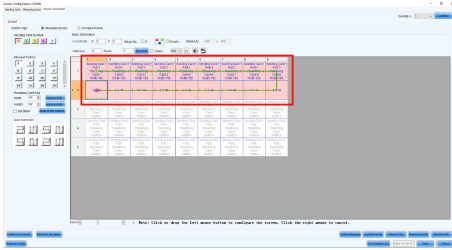

Fig. 21

NOTE: screen is seen from behind

1 Configure Data line 1

2 Configure Data line 2



3 Configure Data line 3

4 Backup settings for port 1, 2 and 3

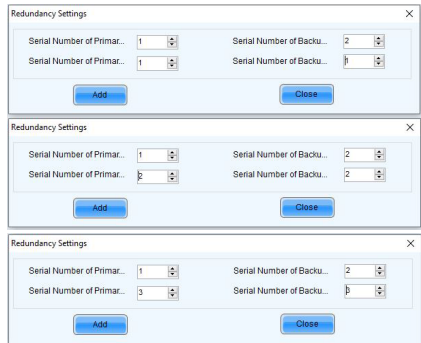
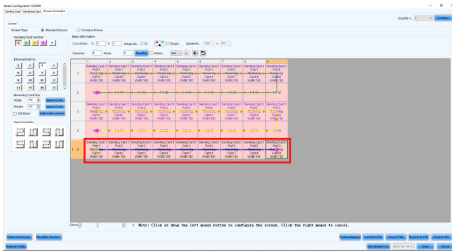

Fig. 22

9 - MAINTENANCE

MAINTENANCE AND CLEANING THE PRODUCT

WARNING: Disconnect from the mains before starting any maintenance work.

It is recommended to clean the front at regular intervals, from impurities caused by dust, smoke, or other particles to ensure that the light is radiated at maximum brightness.

- For cleaning, disconnect the main plug from the socket. It is recommended that you should use a soft antistatic brush to clear dust on the screen surface monthly in order to achieve an optimum displaying effect. Never use a liquid, it might penetrate the unit and cause damage to it.
- The user must clean the product periodically to maintain optimum performance and cooling. The user may also upload firmware (product software) to the fixture via the DATA signal input port using firmware and instructions from PROLIGHTS.
- The frequency of such maintenance operations is to be performed according to various factors, such as the amount of the use and the condition of the installation environment (air humidity, presence of dust, salinity, etc.). It is recommended that the product is subject to annual service by a qualified technician for special maintenance involving at least the following procedures:
 - General cleaning of internal parts.
 - General visual check of the internal components, cabling, mechanical parts, etc.
 - Electrical and functional checks; eventual repairs.

WARNING: the use of alcohol or any other detergent or liquid could damage the product.

- All other service operations on the product must be carried out by PROLIGHTS, its approved service agents or trained and qualified personnel.
- It is PROLIGHTS policy to apply the strictest possible calibration procedures and use the best quality materials available to ensure optimum performance and the longest possible component lifetimes. However, optical components are subject to wear and tear over the life of the product, resulting in gradual changes in colours over many thousands of hours of use. The extent of wear and tear depends heavily on operating conditions and environment, so it is impossible to specify precisely whether and to what extent performance will be affected.
- Use only accessories approved by PROLIGHTS.

MAINTENANCE ON INDOOR PRODUCT

WARNING: The LED display may be damaged and become irreparable if you ignore the following guidelines.

- If the product is used as a fixed LED display, it is recommended that you should use the LED display and its auxiliary devices twice a week and two hours each time. Before using the LED display, perform warm-up operations on the LED display if it has been idle for a long period of time (for details about warm-up operations, see Section 5.5).
- If the product is used as a fixed LED display, check the parts in the distribution box quarterly. Check whether the power cables and signal cables for the LED display are connected securely and safely, and whether the display is grounded reliably.
- If the product is used as a fixed LED display, check whether the steel structure of the fixed LED display is secure on a yearly basis.
- If the product is used as a rental LED display, check whether the ground beam and back frame are secure before you use the product.
- If the product is used as a rental LED display, check whether the parts in the distribution box are secure before you use the product.
- If the product is used as a rental LED display, check the stability and integrity of the flight case before you use the product.
- If the product is used as a rental LED display, place the cabinets into the flight case timely after you finishing using the product. Keep cabinets and internal part of the flight case dry.
- In dry seasons, perform warm-up operations on the LED display and its auxiliary devices at least once every two months if it is idle for a long period of time.
- In wet seasons, perform warm-up operations on the LED display and its auxiliary devices at least once a month if it is idle for a long period of time.

MAINTENANCE ON OUTDOOR PRODUCT

WARNING: The LED display may be damaged and become irreparable if you ignore the following guidelines.

- If the product is used as a fixed LED display, it is recommended that you should use the LED display and its auxiliary devices twice a week and two hours each time. Before using the LED display, perform warm-up operations on the LED display if it has been idle for a long period of time (for details about warm-up operations, see Section 5.5).
- If the product is used as a fixed LED display, check the parts in the distribution box quarterly. Check whether the power cables and signal cables for the LED display are connected securely and safely, and whether the display is grounded reliably.
- If the product is used as a fixed LED display, check whether the steel structure of the fixed LED display is secure on a yearly basis.
- If the product is used as a rental LED display, check whether the ground beam and back frame are secure before you use the product.
- If the product is used as a rental LED display, check whether the parts in the distribution box are secure before you use the product.
- If the product is used as a rental LED display, check the stability and integrity of the flight case before you use the product.
- If the product is used as a rental LED display, place the cabinets into the flight case timely after you finishing using the product. Keep cabinets and internal part of the flight case dry.
- Clean the screen if dust on the screen surface has affected the displaying effect. It is recommended that you should use an antistatic soft brush and in exceptional cases due to excessive dirt use clear water or a small amount of neutral detergent to clean the screen.
- In dry seasons, perform warm-up operations on the LED display and its auxiliary devices at least once every two months if it is idle for a long period of time.
- In wet seasons, perform warm-up operations on the LED display and its auxiliary devices at least once a month if it is idle for a long period of time.

CORRECT STARTUP/SHUTDOWN SEQUENCE

Startup Sequence:

1. Start the distribution box for the LED display.
2. Start the control computer.
3. Start the video processor.
4. Start the sending box.

Shutdown Sequence:

1. Shut down the video processor.
2. Shut down the sending box.
3. Shut down the control PC.
4. Shut down the distribution box for the LED display.

TRANSPORTATION AND STORAGE

The cabinets would be packaged in flight case. The flight case is suitable for packaging of rental LED displays.

Do not place the LED display upside down or throw it during transport and storage, the cabinets must be packaged before transportation. The product shall not be placed upside down or horizontally, and must be protected against the wind, rain, direct sunlight, and corrosive liquid during transportation. The stacking layers shall not exceed two layers for flight cases.

The cabinets of indoor LED displays shall be stored in an environment with ambient temperature ranging from -20°C to +55°C and relative humidity ranging from 10% to 85% RH. For cabinets of outdoor LED displays, the ambient temperature and relative humidity for storage shall be ranging from -30°C to +60°C and 10% to 95% RH. Do not store the cabinets in an environment with chemicals that are volatile, corrosive, or flammable.

GENERAL INDICATIONS FOR USE

WARNING: The LED display may be damaged and become irreparable if you ignore the following warnings:

- Do not incline, scratch, or crash the LED display during installation.
- Do not wet or in case of outdoor models submerge the LED display into water.
- Do not direct the air outlet of an air conditioner to the LED display.
- Do not clean the LED display with chemical solvents.
- Do not place or use the LED display in an environment with volatile, corrosive or flammable chemical products.
- Do not use any electrical accessories not approved by the equipment manufacturer.
- Make sure the LED display and its auxiliary devices are grounded correctly and reliably before they are used.
- *Make sure when assembling the cabinets, to secure the screen and all accessories properly and prevent collapse that may cause damage or danger to people and property, and to use only accessories approved by PROLIGHTS.*
- Switch off the power immediately and contact the professional personnel when the LED display has any abnormal conditions such as peculiar smell, smoke, electric leakage, and abnormal temperature.

The optimum displaying effect may fail to be achieved if you ignore the following cautions.

- Wear antistatic gloves when installing or repairing the product.
- Ensure good ventilation for the LED display when designing the heat dissipation solution.
- Use single-phase power supply for an LED display with the total power consumption not exceeding 3 kW, and three-phase power supply for an LED display with the total power consumption exceeding 3 kW.
- Ensure that the LED display is powered on at least twice per week, and at least 2 hours each time.
- Installing the LED display in the following places may result in an equipment failure and reduce its lifespan: near the sea, in an area with salt and alkali or sulphurous gases, near a kitchen exhaust position, or at a place where the difference between indoor and outdoor temperatures is great. Consult our professional personnel at the service center if the LED display must be installed in any of these places.

TROUBLESHOOTING

Problems	Possible causes	Checks and remedies
Product doesn't power ON	<ul style="list-style-type: none"> No power to the product 	<ul style="list-style-type: none"> Check that power is switched ON and cables are plugged in.
Failure in Lighting up the Display	<ul style="list-style-type: none"> No power is supplied to the display or the control devices. 	<ul style="list-style-type: none"> Check cables between the sending box and the receiving card. Check whether the DVI cable between the control PC and the sending box is connected reliably
	<ul style="list-style-type: none"> The LED display does not have input signals 	<ul style="list-style-type: none"> Check AC power input of the display and the control devices
	<ul style="list-style-type: none"> The control PC is in sleep mode or the graphics card is set incorrectly. 	<ul style="list-style-type: none"> Check whether the control PC is in sleep mode or monitor protection mode. If the control PC is not in sleep mode, check whether the graphics card is configured properly on the software
Incomplete Picture or Incorrect Position of Picture Displayed	<ul style="list-style-type: none"> The connecting file for the screen is incorrect. 	<ul style="list-style-type: none"> Check whether the display's signal cable connection method is same to that of the loaded file xxxx.scr
	<ul style="list-style-type: none"> Receiving card signal cables between cabinets do not contact properly. 	<ul style="list-style-type: none"> Check whether the signal cable is connected to the cabinet receiving card. If the receiving card is faulty, replace the receiving card
	<ul style="list-style-type: none"> The displaying position and screen size are set incorrectly. 	<ul style="list-style-type: none"> Check whether Displaying Position and Screen Size on the software are set to actual screen size
Screen Blinking	<ul style="list-style-type: none"> The ports on the sending box are loose, or the signal cables are too long 	<ul style="list-style-type: none"> Check whether the DVI cable and signal cable are connected to the display and devices, or whether the length of signal cables exceeds the maximum transmission distance (the effective transmission distance shall not exceed 10 m for DVI cable, 100 m for signal cable, 300 m for multi mode optical fiber, and 15 km for single mode optical fiber)
	<ul style="list-style-type: none"> The output resolution of the playing device or sending box is set incorrectly 	<ul style="list-style-type: none"> Check whether the resolution of the playing device and the sending box is greater than or equal to the resolution of the screen
Blinking of a Cabinet in the Display	<ul style="list-style-type: none"> The output of receiving card or hub card is faulty 	<ul style="list-style-type: none"> Check whether the receiving card signal cable and hub card in the cabinet are connected correctly
	<ul style="list-style-type: none"> The receiving card program is incorrect 	<ul style="list-style-type: none"> Check the receiving card program for the cabinet or check the receiving card
Failure in Lighting up of a Cabinet in the Display	<ul style="list-style-type: none"> The power supply, receiving card, or hub card for the cabinet is faulty 	<ul style="list-style-type: none"> Check voltage at the DC side of the power supply and the receiving card power supply. Check the receiving card signal indicator light in the cabinet. Check whether the hub card contacts properly with the receiving card
	<ul style="list-style-type: none"> Signal output of the previous cabinet is faulty 	<ul style="list-style-type: none"> Check output signals of the receiving card of the previous cabinet, or replace the signal cable

Failure in Lighting up Part of the Modules in the Cabinet	<ul style="list-style-type: none"> • Output of the power supply for the modules is faulty 	<ul style="list-style-type: none"> • Check DC voltage for the modules
	<ul style="list-style-type: none"> • Output of signal which controls the related modules is faulty 	<ul style="list-style-type: none"> • Check the hub card ports or flat cables that control the modules
General low light intensity	<ul style="list-style-type: none"> • Dirty led surface 	<ul style="list-style-type: none"> • Clean the fixture regularly.

Contact an authorized service center in case of technical problems or not reported in the table can not be resolved by the procedure given in the table.



PROLIGHTS is a trademark of
MUSIC & LIGHTS S.r.l.
musiclights.it

Via A.Olivetti snc
04026 - Minturno (LT) ITALY
Tel: +39 0771 72190

prolights.it
support@prolights.it