

# 32 Channel Constant Current DMX512 & RDM Decoder

Model No.: D32C(350mA) / D32C(700mA)

RDM/DIP switch/logarithmic dimming

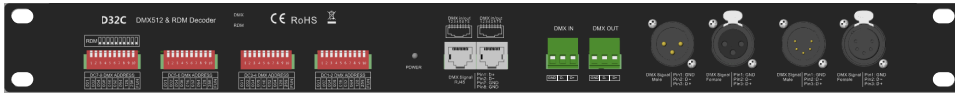

CE RoHS EMC LVD

## Features

- DC12-48V power input, 32 channel PWM constant current output.
- Comply with the DMX512 standard protocols.
- Set DMX decode start address via DIP switch.
- RDM function can realize intercommunication between DMX master and decoder.  
For example, DMX decoder address can be set by DMX master console.
- Green terminal, XLR3, XLR5 and RJ45 port DMX signal input.

## Technical Parameters

Input and Output	
Input voltage	12-48VDC
Output voltage	32 x (3-46)VDC
Output current	32CH, 350 or 700mA/CH
Output power	32 x (1-16.1)W @ 350mA 32 x (2.1-32.2)W @ 700mA
Output type	Constant current

Environment	
Operation temperature	Ta: -30°C ~ +55°C
Case temperature (Max.)	Tc: +85°C
IP rating	IP20

Safety and EMC	
EMC standard (EMC)	ETSI EN 301 489-1 V2.2.3 ETSI EN 301 489-17 V3.2.4
Safety standard(LVD)	EN 62368-1:2020+A11:2020
Certification	CE, EMC, LVD

  

Warranty and Protection	
Warranty	5 years
Protection	Reverse Polarity Short circuit

## Mechanical Structures and Installations

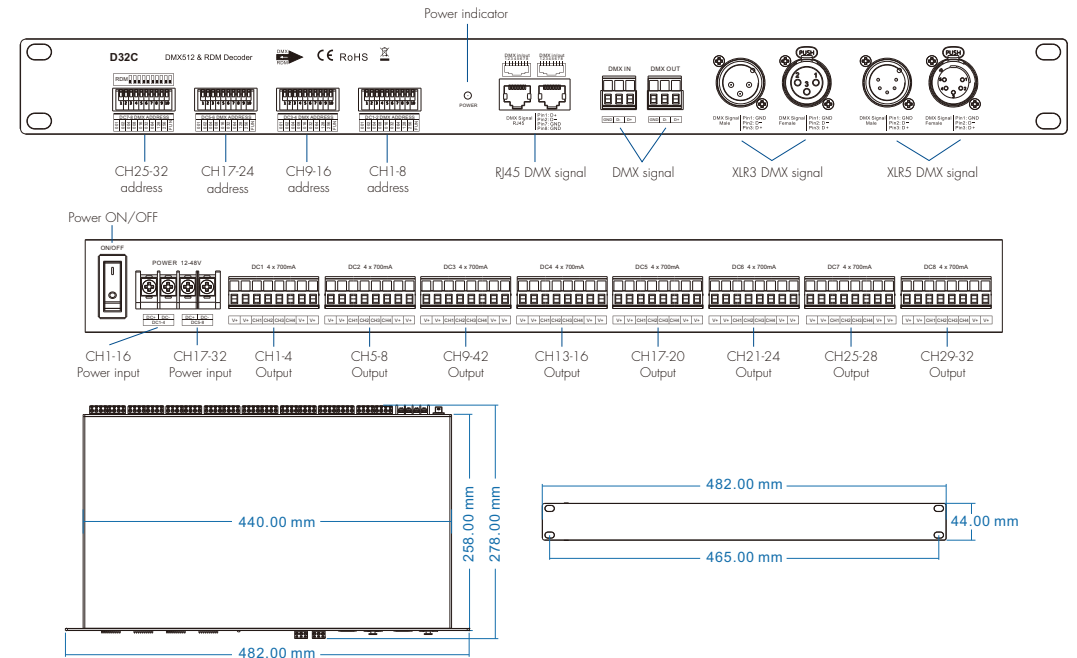

## Wiring Diagram

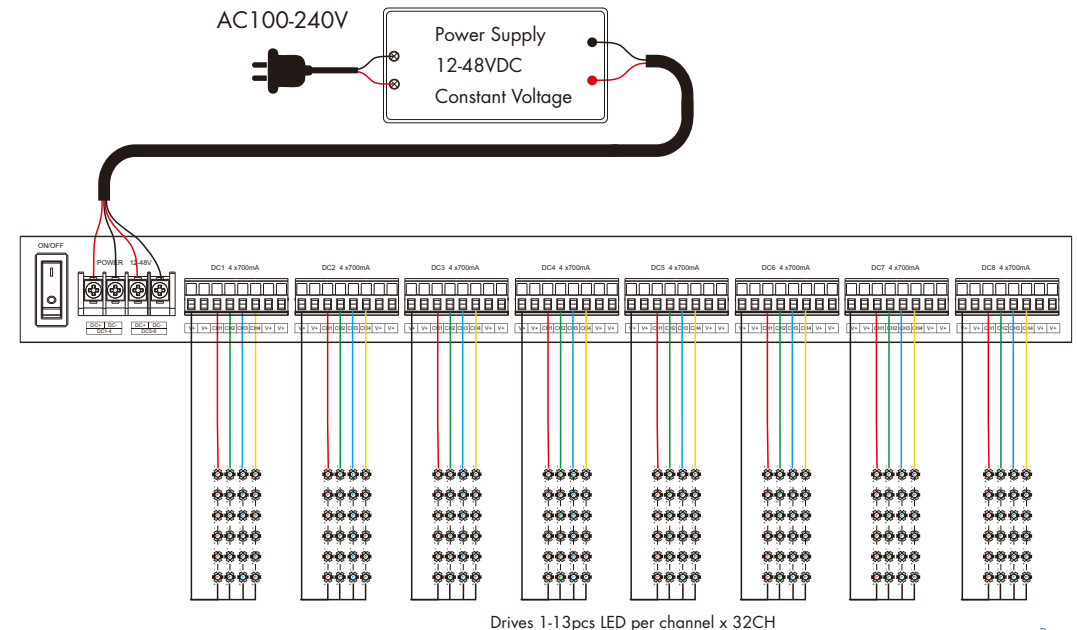

## Wiring Precautions

1. The LED quantity at each channel can be different, the decoder could auto check and output a proper voltage to each channel according to its LED quantities.
2. The decoder works on buck mode, the voltage of power supply should be greater than the total voltage of the series LEDs.
3. An DMX signal amplifier is needed if more than 8 decoders are connected, or use overlong signal line, signal amplification should not be more than 5 times continuously.
4. If the recoil effect occurs because of longer signal line or bad line quality, please try to connect 0.25W 90-120Ω terminal resistor at the end of each DMX signal line.

## DIP Switch



**RDM Mode:** The DIP switch 1-10 are all OFF.



**DMX Mode:** FUN=OFF (the 10th DIP switch = OFF)  
Setting DMX addresses with DIP switch 1-9.



**Self-testing Mode:** FUN=ON (the 10th DIP switch = ON)  
Setting self-testing mode with DIP switch 1-9.

## RDM Mode

When change DIP switch 1-10 to OFF, the defaulted DMX start decode address become 1. then DMX start decode address can be set by DMX/RDM console.

## DMX Mode

DMX start decode address value = the total value of (1-9), to get the place value when "on" position, otherwise will be 0.

4 DIP switch set 4 start address for CH1-8, CH9-16, CH17-24, CH25-32 respectively.

For example, when 4 DIP switch set 1,9,17,25 start address, the total 32 channel occupy 001-032 address:

E.g.1: Set start address to 1.

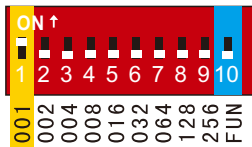

E.g.2: Set start address to 9.

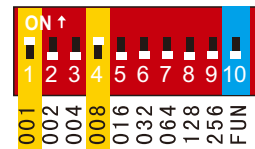

$$001+008=9$$

E.g.3: Set start address to 17.

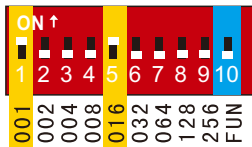

$$001+016=17$$

E.g.4: Set start address to 25.

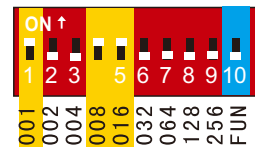

$$001+008+016=25$$

## Self-testing Mode

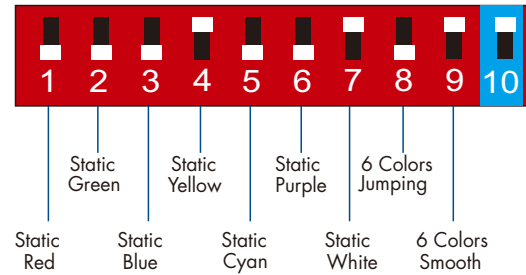

1. For dynamic effects (DIP Switch 8,9 = on) : DIP switch 1-7 is used to get 7 speed levels. (7=on, the fastest level)
2. When several DIP switches are on, subjected to the highest switch value.  
As the figure above shows, the effect will be 6 colors smooth at 7 speed level.

## DMX Dimming

Each D32C DMX decoder occupy 32 DMX address when connecting the DMX console.

For example, the defaulted start address is 1, their corresponding relationship in the form:

DMX Console	DMX Decoder Output
CH1 0-255	CH1 PWM 0-100% (DC1 LED R)
CH2 0-255	CH2 PWM 0-100% (DC1 LED G)
CH3 0-255	CH3 PWM 0-100% (DC1 LED B)
CH4 0-255	CH4 PWM 0-100% (DC1 LED W)
⋮	⋮
CH32 0-255	CH32 PWM 0-100% (DC8 LED W)

## Dimming curve

