

THE
CONFETTIMAKER****
CONFETTI FOR PROFESSIONALS

TCMFX FLAME

JET

Manual



PREAMBLE

Dear TCM Customer,

Please read through these sets of instructions carefully, before using your devices. It contains many Informations which are to help you getting to know your system.

We ask you to follow the safety and usage notes carefully.

Should you have any questions, or any confusions arise during the usage of the devices, which cannot be answered by this manual, please do not hesitate to contact us either by phone or mail.

A lot of fun with your new ignition system wishes you,

CONTENTS

The following manual describes the Gasprojector of the type GX2 230V and GX2 12V (+DMX).

About the Gasprojector GX2

Function of the Gasprojector.

Fields of use and possibilities.

Description of the Gasprojector GX2

Build and components of the hardware.

Usage of the Gasprojector GX2

Preparing the devices for a show

Setting the dip switches of the GX2 12V.

Testing the devices before a show

Igniting the GX2 230V

Igniting the GX2 12V

Igniting the GX2 12V DMX

Other

Build variants of the GX2

Safety hints

Tips & tricks

Technical data

INDEX

1	ABOUT the Gasprojector GX2	6
1.1	Function of the Gasprojectors.....	6
1.2	Fields of use and possibilities	6
2	DESCRIPTION of the Gasprojectors	7
2.1	Components of the GX2 12V	7
2.2	Components of the GX2 230V	8
2.2.1	Description of components.....	9
3	USAGE of the Gasprojectors GX2	14
3.1	Planning the Show	14
3.2	Preparing the devices for the show	14
3.3	Usage and positioning of gas bottles.....	14
3.4	Connecting the gas bottles	15
3.5	Switching the device on (only GX2 12V)	15
3.6	Controlling the GX2 230V	16
3.7	Controlling the GX2 12V	16
3.8	Switching off the device (only GX2 12V)	17
3.9	Dismantling the setup	17
3.10	Storing the system	17
3.11	Taking care of your devices.....	18
4	DESCRIPTION of the dip switch.....	19
5	DIPSCHALTER.....	19
5.1	Explanation of dip switches 1-8	20
5.1.1	In Mastermodule-mode	20
5.1.2	In DMX-Mode	21
5.2	Description of Dip switch 9.....	23
5.2.1	1-channel-mode (switch set to on).....	23
5.2.2	2-cannel-mode (switch set to off).....	23
5.3	Description of switch 10.....	23
6	DMX-MODE.....	23

6.1 Generally.....	23
6.2 Igniting via DMX.....	23
6.3 Optical display.....	25
6.4 Example DMX-Mode.....	25
6.4.1 1. Setting the dip switches	25
6.4.2 2. Connecting single components	26
6.4.3 3. Control.....	27
7 Alternative Built: The GX2 liquid.....	28
8 General safety notes	29
9 Recommended safety distances	29
10 Technical Data.....	30

1 ABOUT THE GASPROJECTOR GX2

1.1 FUNCTION OF THE GASPROJECTORS

The Gasprojector GX2 is an effect device for the creation of straight flame effects of up to 6m height.

The GX2 uses Propane/Butane bottles as a fuel supply, and can also be used with Aerosolee cans by usage of the additional accessory "Aerosolee adapter". Another option is the upgrade of the Projector for use with liquid fuels. In this case, the GX2 is modified in a way that it can access an external pumping station with fuels like Bioethanol, ISOPAR or Isopropylalcohol.

Regardless of the control variant, the Gasprojector always uses a solenoid valve to control the Gas or fluid regulation, as well as an electrical high voltage spark for ignition

1.2 FIELDS OF USE AND POSSIBILITIES

The gasprojector can be used Indoors, as well as outdoors. Its field of use are concerts, stage shows, special effects for theaters and sport events, simple fire shows of fire artists, or as an effect in conjunction with basic fireworks or Wave-Flamers.

Via DMX or special small receivers, the Gasprojector can also be integrated into automated shows. This allows for a musical synchronized use of the Gasprojectors.

The usage of different nozzles and fuels influences the effect height and the setting of the effect time can change the form of the effect (Flame ball or fire pillar).

2 DESCRIPTION OF THE GASPROJECTORS

2.1 COMPONENTS OF THE GX2 12V



Components of the GX2 12V	
1	Electrical ignition
2	Solenoid valve and controller circuitry
3	Connector for gas hose and stopcock
4	Data socket and On/Off switch
5	Charging socket and Lead acid battery

2.2 COMPONENTS OF THE GX2 230V



Components of the GX2 230V	
1	Electrical ignition
2	Solenoid valve
3	Connector for gas hose and stopcock
4	Controlling cable

2.2.1 DESCRIPTION OF COMPONENTS

2.2.1.1 ELECTRICAL IGNITION

The electrical ignition consists of an ignition coil and two electrodes, between which the spark used to ignite the gas is being made. On the GX2 230V the ignition coil is activated directly via the 230V power cable, whereas on the GX2 12V the ignition is controlled via the integrated circuitry.

The spark made at the ignition electrodes is a life hazard. Even though it is covered with a grate, you should not touch any parts near it once the gasprojector is activated.

2.2.1.2 SOLENOID VALVE

In the case of the Gasprojector you can find a solenoid valve, and in the case of the GX2 12V also the controller circuitry. The solenoid valve is used to regulate the gas flow and is activated via the 230V power supply on the GX2 230V, or the controller circuitry on the GX2 12V.

2.2.1.3 CONNECTOR FOR THE GAS HOSE AND THE STOPCOCK

The front of the GX2 features the connector for the gas hose, as well as the stopcock to stop the gas. The gas connector is a 10L threading.

The optionally available Aerosolee adapters for gas cans can also be fixed to this mount.

If the stopcock is in a 90° angle, the pipe is closed. If it parallel to the piping, it is open. **Never store the gasprojector with a closed stopcock, since rest gas can damage the internal sealings**

2.2.1.4 CONTROLLER CABLE (GX2 230V)

The Gasprojector GX2 230V features a standard 3m cable with a two-pin grounded plug (CEE 7/7). It is used to connect the GX2 230V to the needed supply of 230V. As long as the voltage is given, the gasprojector will ignite.

Alternative	Instead of the integrated cable, PowerCon-connectors (In and Out) can be built into the Gasprojector.
--------------------	---

2.2.1.5 CONTROLLER CIRCUITRY

The integrated electronic of the GX2 12V uses any ignition signals coming from outside and transmits and ignition or other commands to the ignition coil and the solenoid valve. A built in dip switch allows you to set a DMX channel (1-255) in DMX mode, or setting a standardized opening time for use with an RX-1K Gas.

The controller circuitry also features a connector for the external ignition via 9-80VDC. It is normally built as a twin pole cable. If the GX2 is fitted with an RX-1K Gas, this cable is no longer built into older models.

The connector clamps can be dismantled from their sockets with the two cross headed screws on either side. If you should wish to remove the internal circuitry, for example to make an update, please **only unscrew the connector terminal blocks from their sockets**, and not every single cable. The electronic can be dismantled by loosening the two Inbus screws on the back side of the Gasprojector.

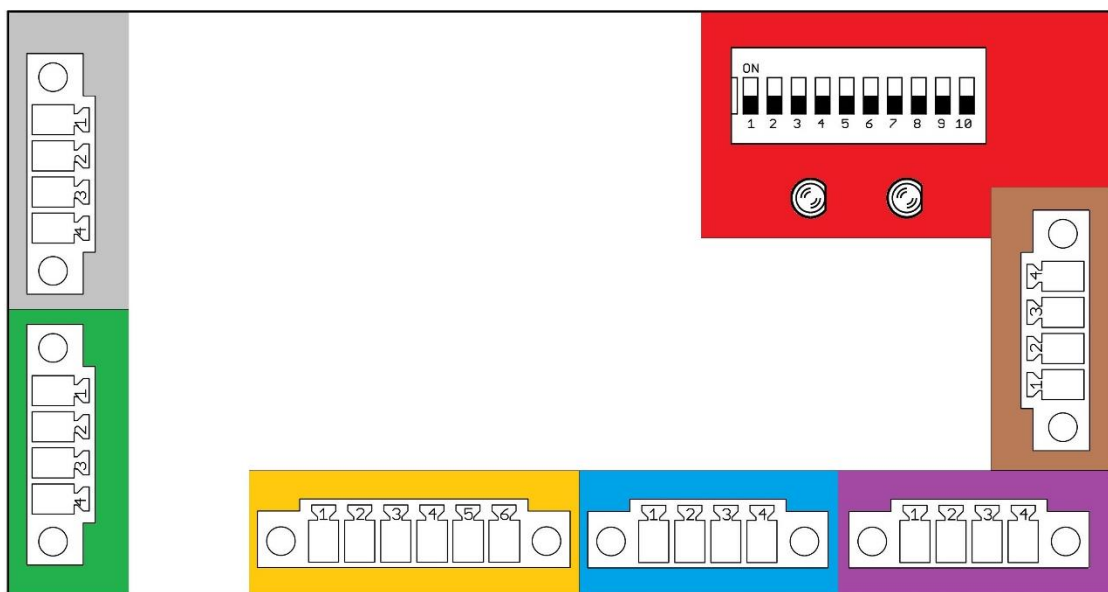

Connectors on the controller circuitry	
	Ignition coil
	Charging socket, battery, On/Off switch
	Mastermodul
	DMX
	RX2-1K Gas
	External ignition, solenoid valve
	Status-LEDs, Dip switches

2.2.1.6 DATA SOCKETS AND ON/OFF SWITCH (GX2 12V)

The front of the Gx2 12V features the data sockets, as well as the On/Off switch. The GX2 12V van be controlled via the data sockets. It is standard fit with connectors for the radio receiver RX-Mastermodule (In and Out). Optionally, it can also be fitted with connectors for the DMX protocol, or a connector for the receiver RX-1K Gas. The following standard fits are available for the GX2 12V:

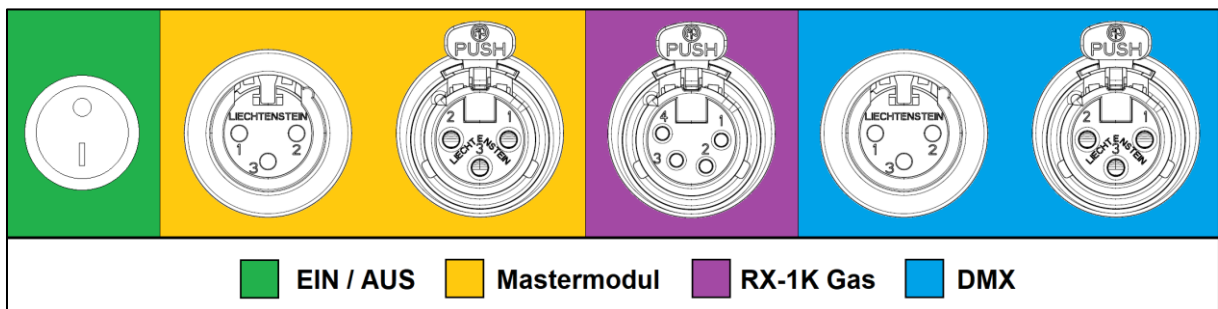
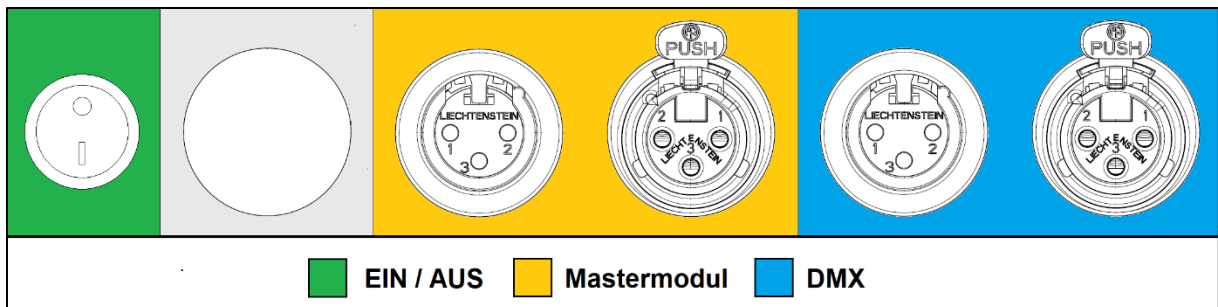
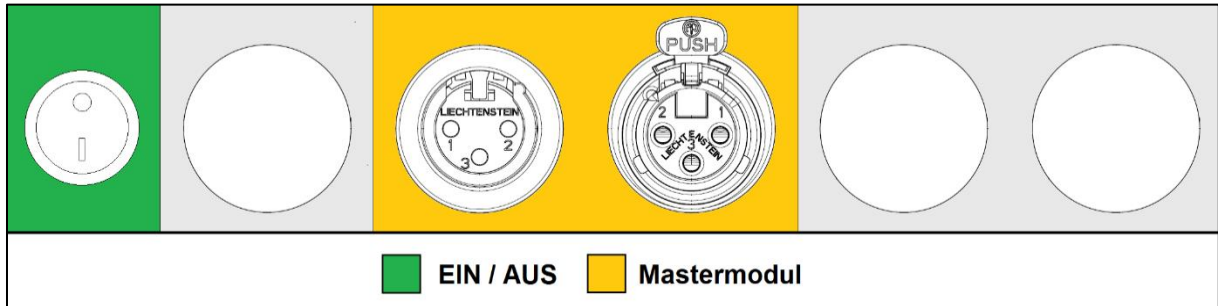

The pins of the data sockets have the following layout::

	Pin 1	Pin 2	Pin 3	Pin 4
Mastermodule	GND	+12VDC	DATA	/
DMX	GND	B	A	/
RX-1K	GND	+12VDC	IGNITION -	IGNITION +

2.2.1.7 CHARGING SOCKET AND LEAD ACID BATTERY (GX2 12V)

The GX2 12V is fitted with a separate charging socket on the left side of the device, to which a fitting charger can be mounted (we recommend an Optimate charger). The charger is not standard supplied with the GX2.

The pin layout is as follows:

	Pin 1	Pin 2	Pin 3
Charging socket	GND	+12VDC	/

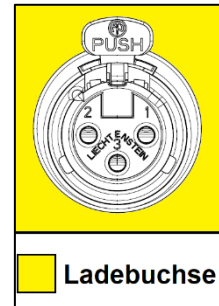

As a power supply for the GX2 12V a standard 12VDC lead acid battery (2.200mAh) is used. It is fit to the inside of the device with a mounting bracket and is charged via the aforementioned charging socket. The battery should be recharged before and after each show, as well as every 2 months when stored for a longer time., since it could lead to deep discharge otherwise, which damages the battery-

If needed, a second lead acid battery can be fit to the other side of the Gasprojector.





Alternative	Instead of the built in lead acid battery, a mains supply (230VAC to 12VDC, class IP67) can be built in. In this case, two PowerCon connectors (In and Out) would be fit to the fron panel which supply the mains supply.
--------------------	---

2.2.1.8 GAS NOZZLE

On the head of the Gasprojector, underneath the ignition, a gas nozzle can be found, through which gas is ejected during ignition.

When selecting a nozzle, one must make a distinction between using one for Aerosolee cans or gas bottles. Further you must decide between liquid or gaseous gas. Gaseous gas use occurs when you are using your gas bottle right side up. Liquid gas use is made when the bottle is flipped onto its head. Generally it can be said that during liquid use, higher flame effects can be achieved, but the fuel consumption is also heightened. Also, dirt can collect on the bottom of the bottle, which can block the nozzles during liquid use.

A detailed description of the different nozzles can be found on the next page (Note: Only the two Outdoor nozzles are standardly supplied with the gasprojector).

	Product	Gas usage	Flame height	Maximum shots	Flame look
Gas nozzle, gaseous With or without reduction		Propane/Buthane gaseous	3m	180 Shots / 1sec Opening time 280 Shots / 100ms Opening time	Fire balls and Flame pillars
		Propane/Buthane liquid	not possible	-	-
		Aerosole gaseous	1m	140 Shots / 100ms Opening time (nur bei 100ms verwenden)	Short, small Fire balls and Flame pillars
		Aerosole liquid	not possible	-	-
Gas nozzle, liquid With or without reduction		Propane/Buthane gaseous	not possible	-	-
		Propane/Buthane liquid	6m	70 Shots / 1sec Opening time 160 Shots / 100ms Opening time	Fire balls and broader Pillars
		Aerosole gaseous	not possible	-	-
		Aerosole liquid	5m	27 Shots / 1sec Opening time 70 Shots / 100ms Opening time	Fire balls and broader Pillars, longer Shots not possible
Aerosol nozzle With reduction		Propane/Buthane gaseous	not possible	-	-
		Propane/Buthane liquid	3m	270 Shots / 1sec Opening time 800 Shots / 100ms Opening time	Thin flame pillar
		Aerosole gaseous	not possible	-	-
		Aerosole liquid	3m	27 Shots / 1sec Opening time 70 Shots / 100ms Opening time	Thin flame pillar
Reduction		The reduction prevents an afterburn at the nozzle and can be obtained for every nozzle type. Please contact the manufacturer for further informations about the upgrade with reductions.			
<p>***The data supplied above is meant for a 10Kg gas bottle (Propane/Buthane mix), or two aerosole cans with 330g each, 20°C outer temperature and no wind. Wind and cold can affect flame height and look strongly***</p> <p>***Taking into account the recommended safety distances all nozzles can be used outdoor and indoor!***</p>					

3 USAGE OF THE GASPROJECTORS GX2

3.1 PLANNING THE SHOW

A successful show begins with careful planning. We recommend taking note of these factors:

Checklist for planning
Are Gasprojectors allowed at the location?
Can the needed safety distances be kept?
How many gasprojectors do I wish to use?
What flame height do I wish to use? (selecting a nozzle!)
Optional: Do I want to use aerosole cans or a gas bottle?
Optional: Planning the automated show (only when controlling via radio).

3.2 PREPARING THE DEVICES FOR THE SHOW

Nothing is more maddening than a gasprojectors whose battery is already empty before the show, or if the gas hose has been forgotten at the storage facility. So these items should be checked before driving to the show:

Checklist before the show
Do I have all the gasprojectors needed with me?
Do I have the right nozzles?
Do I have enough gas hoses / Aersosole adapters?
Are the batteries of my gasprojectors charged?
Do I have a spare charger / spare battery with me?
Are the ignition electrodes cleaned?
Do I need further accessories? (Tripod, socket wrench, connector cables?)
Do I have the necessary controllers with me and programmed?
Optional: Do I have the external pumping station? (only with GX2 liquid)

If the above questions can be answered with YES, you are one step closer to a successful show.

3.3 USAGE AND POSITIONING OF GAS BOTTLES

The general safety guidelines for the usage with gas, as well as the instructions on the safety datasheet of the used gas are to be adhered. Generally propane is heavier than air, so it should not be used in unventilated areas, ground indents (deeper than 20cm) or near waste pipes. Especially near cellars, an ignitable gas-air mixture can appear. Only use CO² extinguishers to extinguish flames.

The gasprojector may only be used in ventilated rooms. For the safety distances, the following is true:

Generally, the gasprojector must have enough distance to all living beings and objects, so that they may not be harmed or endangered using the device. The manufacturer recommends 3 meters in a radius, and 8 meters in height to all objects and persons (standard GX2 variant, outdoor nozzle liquid). However, please adhere to the safety distances as laid out by the local fire department. Please take note of wind direction when setting up your devices.

For positioning, it is recommended to have the connectors not face the audience.

3.4 CONNECTING THE GAS BOTTLES

The gas bottles must be placed on firm, even ground, and be proofed against accidental tipping. The gas hose should be connected to the gasprojector first, and then the gas bottle. Before connecting to the gas bottle, make sure the stopcock of the projector is closed.

It is recommended to test for leak tightness, using a leak tightness spray.

The gas bottle connector is a Euro-connector with 30mm wrench width. Note that the gas connector has a left threading. Up to 3 gasprojectors can be connected via T-adapters to a single bottle. Should you have more than 3 gasprojectors in use, you must use further gasbottles

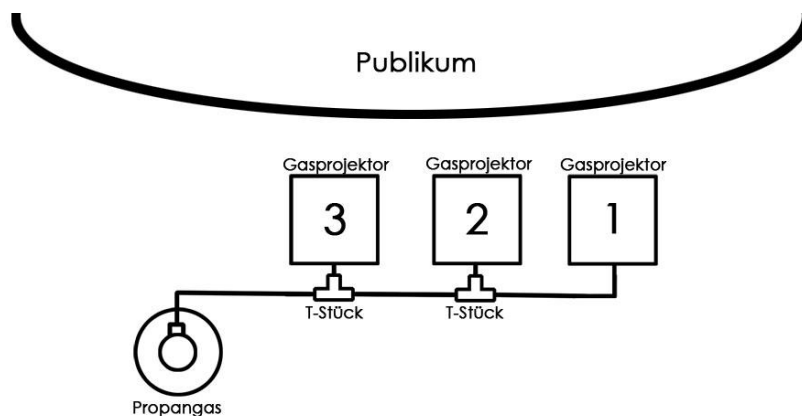

Alternative

When using aerosole adapters, the adapter must first be mounted to the device. Then the aerosole cans can be mounted to the adapter with the valves closed.

3.5 SWITCHING THE DEVICE ON (ONLY GX2 12V)

The device can be switched on via the Wipp-switch on the front of the GX2. Put the switch into the "I" position. Using the Status-LEDs you can see if the device has been switched on.

Red LED when switching on (Status of the internal battery)	
3x flashing	Battery fully charged
2x flashing	Battery weak
1x flashing	Battery must be charged

Green LED after switching the device on

Steady light

Shows that the projector is activated.

3.6 CONTROLLING THE GX2 230V

Control of the GX2 230V is exclusively made via supplying the device with a voltage of 230VDC with the two-pin grounded plug. Simply put: Plug connected to socket > device ignited, plug disconnected > device doesn't ignite.

The gasprojector will ignite for as long as it is supplied with sufficient voltage. Setting the opening time at the device itself is not possible. For a controlled ignition, it is recommended to get a switch box, a DMX Switch Pack (not a Dimmerpack!) or anything close to that.

Important: Steady use (a continuous flame) can damage the GX2 230V. It is recommended to not leave it active for more than 5 or 6 seconds, with a 2 second pause in between (short bursts are however continuously possible).

3.7 CONTROLLING THE GX2 12V

Control of the GX2 12V can be made with 4 different options:

1.) Control via the RX-Mastermodule (Radio variant)

→ **see manual of the RX2-Mastermodule**



2.) Control via the RX2-1K Gas (Radio variant)

→ **see manual of the RX2-1K Gas**



3.) Control via an external ignition trigger

This allows you to ignite the gasprojector by use of an external trigger on the twin pole cable. As long the trigger is made on the cable, the effect will ignite. The opening time can be set on the dip switches. Further informations can be found in the description of the dip switches.

An ignition trigger must be between 9 - 80 VDC (eg. Ignition of an EXPLO receiver. For the trigger, polarity need not be cared for).

4.) Control via DMX (optional)

→ see Chapter DMX-Mode

3.8 SWITCHING OFF THE DEVICE (ONLY GX2 12V)

To switch off the device, set the wipp switch to the "O" position. Check if the device is switched off by use of the Status-LEDs.

3.9 DISMANTLING THE SETUP

After usage of the system, first close the valve at the gas bottle or the aerosole cans. **Then air out the hose or the adapter and the gasprojector, by igniting it until no flame appears.** After airing it, the gasbottle or cans can be disconnected, and the gas hose or adapter from the gasprojector. Never transport gasprojectors under pressure, since this carries a high risk to you, as well as it might damage the gasprojector.

3.10 STORING THE SYSTEM

Store gas bottles according to the law. the manufacturer of your gas bottles can tell you more about this.

The gasprojectors should be stored at room temperature ideally. Never store them under pressure (rest gas). This not only poses a high security risk, but it might also damage the seals of the device.

Should you use a gasprojector GX2 12V with integrated battery, charge it before and after every show, as well as every 2 months during storage. Lead acid batteries discharge during storage by themselves, which can lead to a damage of the battery, if not prevented with regular charging.

Clean your devices before storage.

3.11 TAKING CARE OF YOUR DEVICES

The devices should be cleaned after a show. Simply remove dirt and dry out the devices. The use of pressurized air is recommended.

If the ignition electrodes are very dirty, carefully clean them with a wire brush. Disconnect the device from any sort of power supply for this.

Additionally, you can remove coilings and plungers from the solenoid valve, and clean the inner tubings of the valve with pressurized air. Even though there is an internal sieve, dirt from the gas bottle can be accumulated here.

4 DESCRIPTION OF THE DIP SWITCH

The integrated 10 step dip switch allows you to change different settings, such as the DMX channel or the opening time during mastermodule usage, before using the gasprojector.

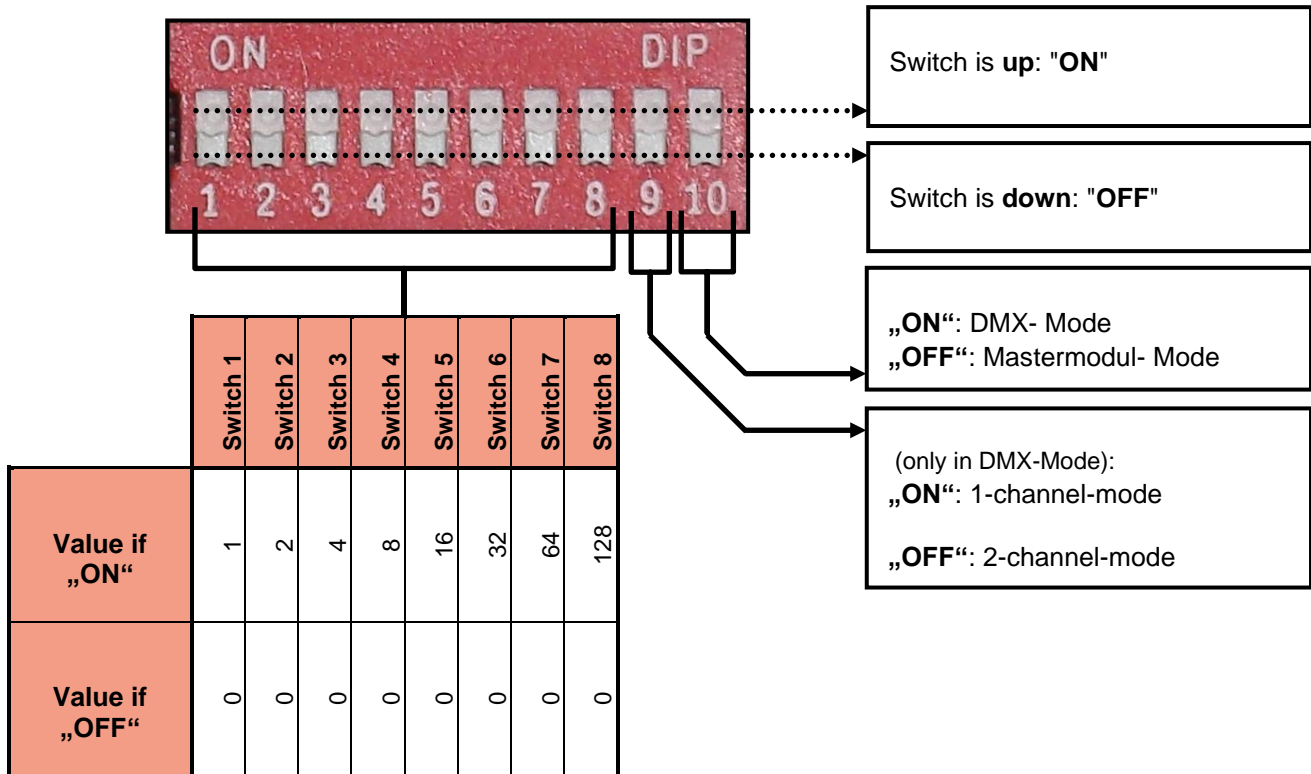

The dip switch has 10 single switches (see picture above). The switches 1-8 (from left) allow you to set the opening time in mastermodule mode, or the DMX channel in DMX mode. Switch 9 is used to change between 1 channel DMX mode (only ignition channel) to 2 channel DMX mode (ignition and safety channel). Switch 10 allows you to select between DMX or mastermodule mode.

5.1 EXPLANATION OF DIP SWITCHES 1-8

Each of the 8 switches has its own (according to the binary system) value (see table below), which is added if the switch is set to "ON" (switch is in the upper position). The sum of all 8 switch values gives you the opening time, or the DMX channel.

5.1.1 IN MASTERMODULE-MODE

In Mastermodule mode, the switches 1-8 are used to set the opening time of the external ignition.

Switch	Opening time (ms)
1	20
2	40
3	80
4	160
5	320
6	640
7	1280
8	2560

20

Example for the opening time:

An opening time of 400ms should be used. It is made by adding the values of $80+320 = 400$. These values are given to the switches 3 (opening time 80ms) and 5 (opening time 320ms).

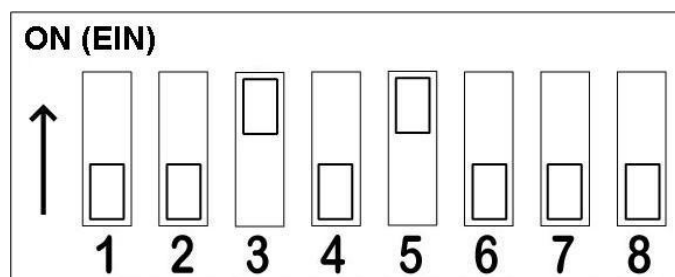

Therefore, to create an opening time of 400ms the switches 3 and 5 must be set to "ON" and all others to "OFF".

5.1.2 IN DMX-MODE

In DMX mode, the switches 1-8 are used to assign the DMX channel.

Switch	Value
1	1
2	2
3	4
4	8
5	16
6	32
7	64
8	128

Example for DMX channel:

Channel 14 should be set. Therefore the value of all switches must be 14. This sum is made by adding the values $2+4+8 = 14$. These values are assigned to the switches 2 (Value 2), 3 (value 4) and 4 (value 8).

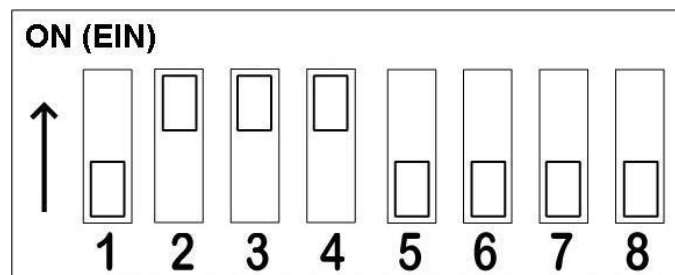

So to set channel 14, set switches 2, 3 and 4 to "ON" and all others to "OFF".

5.1.2.1 SWITCH SETTINGS FOR THE FIRST 16 DMX CHANNELS:

22

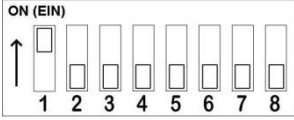
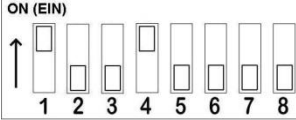
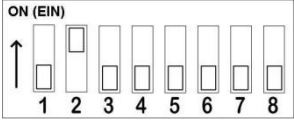
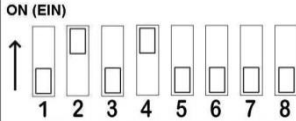
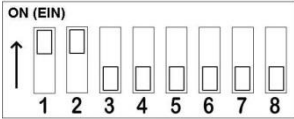
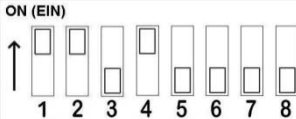
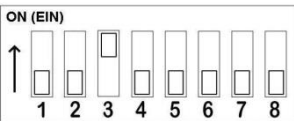
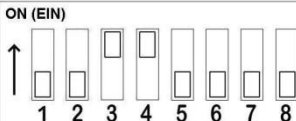
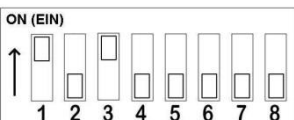
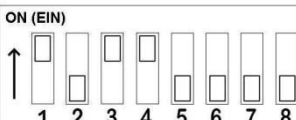
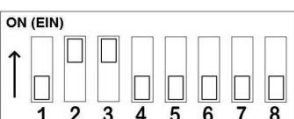
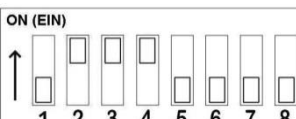
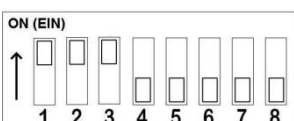
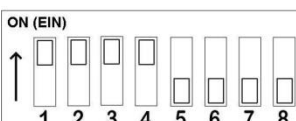
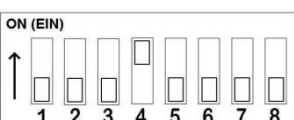
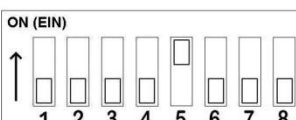
Channel	Dip switches 1-8	Channel	Dip switches 1-8
1		9	
2		10	
3		11	
4		12	
5		13	
6		14	
7		15	
8		16	

5.2 DESCRIPTION OF DIP SWITCH 9

Allows you to change between 1 channel mode and 2 channel mode in DMX mode.

5.2.1 1-CHANNEL-MODE (SWITCH SET TO ON)

If dip switch 9 is set to "ON" in Dmx mode, only the starting channel will be used to control the projector. The safety channel (channel2) will be set internally to DMX value 200, meaning that the Porjector ignites if channel 1 has a DMX value of over 253.

The device will ignite as long as channel 1 is over 253, only for 3.8 seconds however.

The 1 channel mode is contrary to 2 channel mode a very unsafe method of usage. It is always recommended to use the 2 channel method.

5.2.2 2-CANNEL-MODE (SWITCH SET TO OFF)

The gasprojector is controlled with 2 DMX channels, as detailed in the manual.

5.3 DESCRIPTION OF SWITCH 10

This switch allows you to change between mastermodule use and DMX use. "ON means DMX-mode, "OFF" is mastermodule-mode.

6 DMX-MODE

6.1 GENERALLY

The gasprojector will be controlled either via one or two DMX channels. The first DMX channel is the channel the gasprojector is set to via the dip switches. It is used for igniting the device. The second DMX channel is a follow up to the first. It is used to set the opening time of the gasprojector.

6.2 IGNITING VIA DMX

To ignite a gasprojector, you must first set the preferred opening time at channel2. The channels are divided between 0-255, whereas the value of 255 is a completely activated slider (100%). (see the graphics on the next page). The opening time is calculated in milliseconds as follows:

$$\text{(Value of Slider - 10) * 20ms = Opening time in ms}$$

For the value of the slider for the opening time, the following should be noted:

Slider value channel 2 (Opening time)	Description
1-10	Not usable, safety zone
11 - 200	Gasprojectorfunction: The values of this zone can be used to set the opening time. <i>Minimum:</i> Value 11 = 20ms <i>Maximum:</i> Value 200 = 3800ms
201 - 250	Gastorchfunction: If the channel is in this zone, the device will ignite permanently, and will start a safety ignition every 5 seconds.
251 - 255	Not usable, safety zone

Examples for opening times:

Opening time	Slider value	Description
60ms	13	Small fireball
100ms	15	Flame pillar
500ms – 1000ms	35 - 60	Larger Flames

Only after setting the opening time, the gasprojector can be ignited by sliding channel 1 over a value of 253.

Green LED in DMX-Mode	
Flashes rapidly	Devices receives a DMX signal

Red LED in DMX-Mode	
Flashes	Device ignites

6.3 OPTICAL DISPLAY

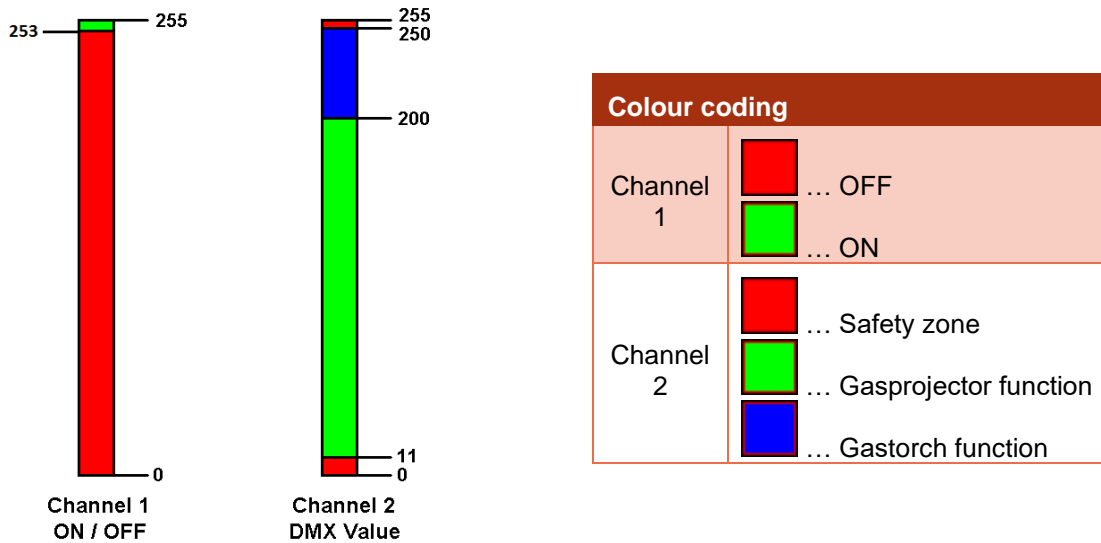

6.4 EXAMPLE DMX-MODE

Example: We have a DMX mixing table and want to use the third slider to ignite a GX2.

25

6.4.1 1. SETTING THE DIP SWITCHES

Explanation: Before using the GX2, the DMX address of the first DMX channel (ignition channel) must be set per use of the dip switches 1-8. Also switch 10 must be set to "ON" to use DMX-mode.

Steps: Using the value table for the dip switches in DMX-mode we must calculate which switches need to be set "ON", and which ones "OFF", to get the preferred DMX adress of 3.

Switch	Value
1	1
2	2
3	4
4	8
5	16
6	32
7	64
8	128

1 + 2 = 3
(Sum of values = Adress)

The address can only be achieved by adding the values of 1 and 2 (green in the table above). These values are set to the switches 1 and 2. So to set address 3 we need to set switch 1 and 2 to "ON", and switches 3 - 8 to "OFF". Switch 10 must be set to "ON" in DMX-mode (If "OFF", it would be in Mastermodule-mode).

Result: To use a gasprojector in DMX-mode with ignition channel address 3, the following settings must be made on the dip switches:

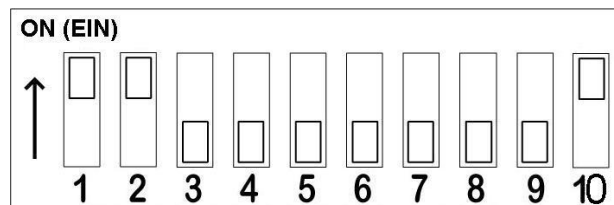

6.4.2 2. CONNECTING SINGLE COMPONENTS

Explanation: After setting the dip switches on the gas projector, the device can be connected to our DMX- mixer.

Steps: We connect the DMX-output of the DMX mixer with the DMX-Input of the Gasprojector. We are using a 3 pole XLR cable, on which the pins are lined through directly (Pin1 is Pin1, Pin2 is Pin2, Pin3 is Pin3). We recall that the DMX-input is the socket labeled "DMX IN".

Since we are only using one device in our example, the DMX output labeled "DMX OUT" is not connected.

! Important: To guarantee a successful show, you should use a stabilizing battery or charger at the charging socket labeled "Master OUT / Charger".

Result: The set up should look as follows:

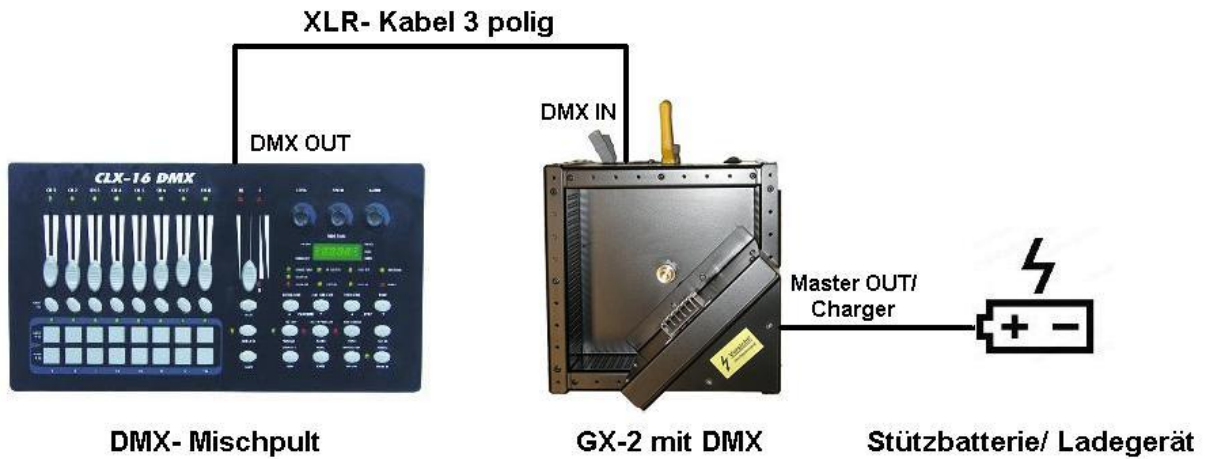

6.4.3 3. CONTROL

After a successful set up, the gasprojector can be switched on and be controled from the DMX mixer. As preferred, channel 3 is our ignition channel, the following channel (channel 4) is thus the one used to set the opening time.





Note

Of course you can control multiple gasprojector with a mixer. Simply connect the DMX OUT of one gasprojector, with the DMX IN of the next one.

If multiple devices are to be used with the same power supply (eg. charger), you also need to connect the Master OUT / charger sockets of the devices with the Master IN of the next device, and connect the power supply to the last one in the row. It is not possible to charge the devices via the DMX connectors!

7 ALTERNATIVE BUILT: THE GX2 LIQUID

Additionally to the GX2 230V and the GX2 12V an alternative built, for use with liquid fuels is available. Since the GX2 Liquid does not feature an internal pump, the pressure needed and the fuel supply must be made with an external pumping station. Any pumping station featuring a maximum pressure of 14bar can be used. For fuel, you can use Bioethanol, ISOPAR, or Isopropylalcohol.



28

As pictured above, the GX2 liquid uses a different built of its head. Special nozzles for liquid fuels are being used. The standard nozzle can achieve a height of 8 - 10 meters with optimum pressure. With an optionally available aerosol nozzle, a height of about 4 to 5 meters can be achieved.

An advantage of the GX2 liquid is the possibility to use liquid fuels. A disadvantage is that you are no longer able to use liquid gas from a standard gas bottle.

For the use of the GX2 Liquid, separate safety distance are needed.

8 GENERAL SAFETY NOTES

The device may only be used if it is in good condition. Defective devices must be repaired by either the manufacturer, or an accredited service partner. Under no circumstances may such devices be used.

The devices are to be placed firmly in a fit place. The gasprojector should be placed horizontally on the ground ideally.

The safety distances mentioned in the manual are to be adhered. All persons taking part in the gasprojector show (Actors and the likes) should be made aware of the safety distances, dangers and basic function of the device.

The person responsible for controlling the gasprojectors should always have a line of sight to the devices. Ideally directly, or alternatively via cameras. This person must make sure the safety distances are adhered to, and be able to interrupt the show at any given time in case of danger.

Before usage, the system should be checked for leak tightness, to prevent an unwanted escape of gas. Should gas be escaping at an unwanted location, all safety valves should be closed, and the dangerous area be left.

9 RECOMMENDED SAFETY DISTANCES

Direction of ejection	Gas nozzle (liquid)	Gas nozzle (gaseous)	Aerosol nozzle
Upwards	8 Meters *)	6 Meters *)	4 Meters*)
Around the effect	3 Meters *)	2,5 Meters *)	2 Meters *)

*) The distances mentioned above are only true for the use with EXPLO outdoor nozzles and indoor nozzles and are meant for distances towards flammable objects or audiences. Concerning non flammable materials and for actors / technicians, this safety distance can be reduced.

If learned pyrotechnical personnel uses the projector, the distances mentioned above can be adjusted according to the given circumstances, and when considering dangers and risks.

The values mentioned above are meant for no wind and ignition of a large flame effect. The safety distances mentioned above are merely recommendations. For the positioning and calculation of the safety distances, the user has the last word. It is recommended however, to consult the fire department responsible for the location.

The safety distance should be heightened, if easily flammable materials are in the ejection direction.

10 TECHNICAL DATA

GX2 230V	
Measurements	260x260x390mm
Weight	5,8kg
Power Supply	230VAC
Case	Aluminium (Head from stainless steel)
Gas connector	Euro-Norm, 30mm Wrench width
Fuel	Propane / Buthane

GX2 12	
Measurements	260x260x390mm
Weight	6,8kg
Power Supply	12VDC Lead-acid-battery
Stand-By	16 Hours (with one battery)
Case	Aluminium (Head from stainless steel)
Gas connector	Euro-Norm, 30mm Wrench width
Fuel	Propane / Buthane

GX2 230V liquid	
Measurements	260x260x325mm
Weight	5,8kg
Power Supply	230VAC
Case	Aluminium (Head from stainless steel)
Gas connector	Euro-Norm, 30mm Wrench width
Fuel	Propane / Buthane, Liquid fuels

GX2 12V liquid	
Measurements	260x260x325mm
Weight	6,8kg
Power Supply	12VDC Lead-acid-battery
Stand-By	16 Hours (with one battery)
Case	Aluminium (Head from stainless steel)
Gas connector	Euro-Norm, 30mm Wrench width
Fuel	Propane / Buthane, Liquid fuels