

Pixel Triton

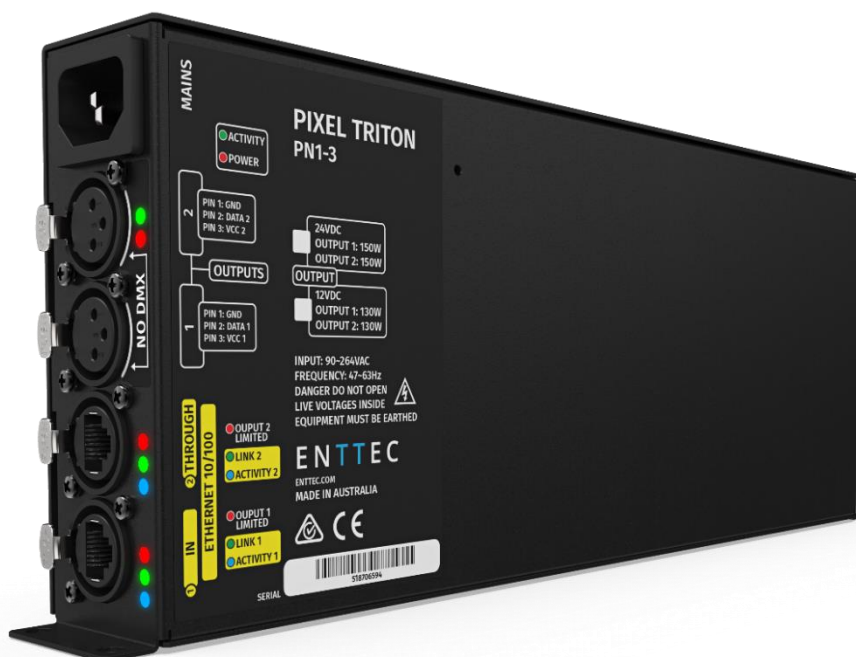

Features

- Web configurable
- Firmware updateable
- Supports the following DMX over Ethernet protocols:
 - Art-Net
 - Streaming ACN (sACN)
- Configurable Static or Dynamic (DHCP) IP (DHCP by default).
- Netmask and gateway updateable
- Up to 8 ethernet universes support (maximum of 4 universes per output port)
- Configurable pixel ordering.
- Monitors and maintains device temperature
- Monitors and displays the power consumed by each output
- Detects and indicates when the power consumed by an output is on or above the recommended value
- Monitors and displays the network traffic for the DMX over ethernet protocol enabled
- Easily extendable network – daisy chain ethernet connection
- Web faders for instant testing of setup

Safety Information

- This unit is intended for indoor use only.
- Do not expose this device to rain or moisture, doing this will void the warranty.
- Make all the connections before you plug in the mains power
- Do not remove the cover, there are no user serviceable components inside.

- Never plug this unit in to a dimmer pack
- Ensure proper earth connections
- Always be sure to mount this unit in an area that will allow proper ventilation. Allow about 6 inches (20 cm) between this device and a wall.
- Power-supply cords should be routed so that they are not likely to be walked on or pinched by items placed upon or against them, pay particular attention to the point they enter and exit the unit.

Physical Dimensions

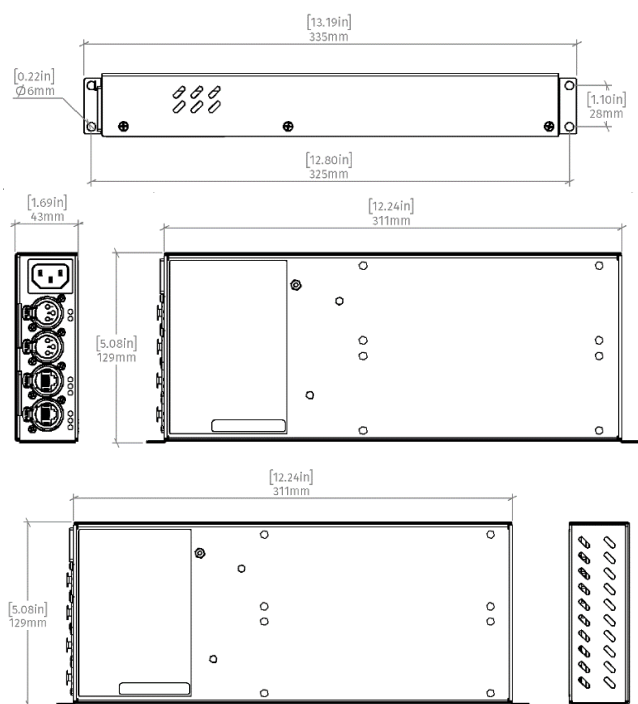

Ordering Information

Part Number	Description
75020-12	Pixel Triton (12VDC)
75020-24	Pixel Triton (24VDC)

Specifications

Item	Product Name	
	75020-12	75020-24
Input Voltage	90 – 264V AC	
Input Frequency	47 - 63 Hz	
Maximum Total Output Power	260 W	300 W
Maximum /output	Power	130W
	Current	10.83A
Supported Protocols	Artnet 1/2/3, sACN	
Output Protocols	WS2811, WS2812, WS2812B, WS2813, SK6812, TM1804, TM1812, UCS2903, UCS2904, APA-104, 9PDOT (8 – 16bit)	
Maximum Pixel count/output (RGBW)	512 RGBW pixels	
Maximum Pixel count/output (RGB)	680 RGB pixels	
Maximum DMX footprint/output	2048 channels	
Operating Temperature	-10 °C – 35 °C	
Relative Humidity	20% - 90% (Non-condensing)	
Connectors	2X RJ45 etherCON 1 X IEC connector 2X 3-Pin Female XLR	
IP Rating	IP20	
Cooling Method	Smart fan	
Weight (in kg)	Device	2.02
	Boxed Device	2.35
Dimensions (in mm)	Device	335(L) x 129(W) x 43(H)
	Boxed Device	400(L) x 215(W) x 115 (H)

Wiring Diagrams

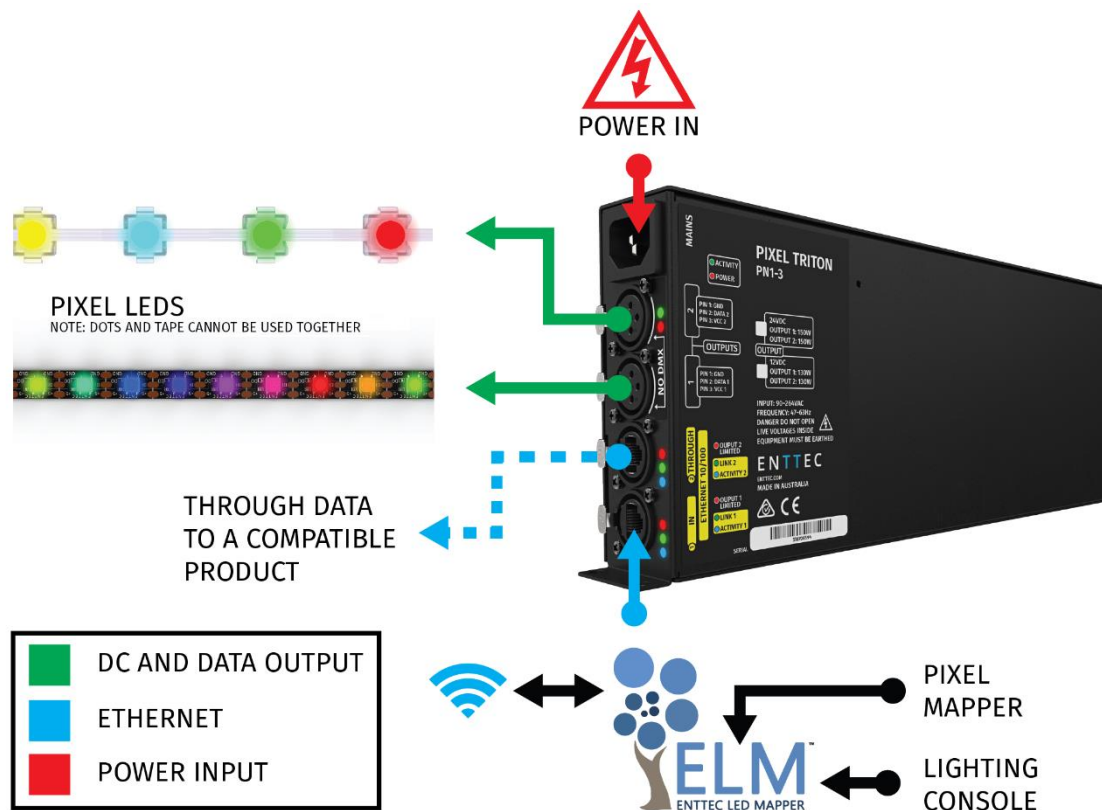

- Always check that the voltage and output of Pixel Triton matches that of the tape/dots, before connecting.
- Network delay: 96 micro seconds per unit, for a standard 600 bytes Art-Net packet (when connected in network daisy chain)
- Only one ethernet source must be used to drive the device at any single time.
- Ensure distance between Triton data output and tape/dots data input is no more than 50cm
- Through connection can be made with any of the three models Pixel Port, Pixel Octo or Pixel Triton

Output 3-Pin Female XLR Pinout

Female	Pin 1	Ground	
<p>Not to be used as DMX output</p>	Pin 2	Data	
	Pin 3	12V Triton	+12 VDC
		24V Triton	+24 VDC



Do not connect the Positive voltage of output 1 (VCC 1) to positive voltage of output 2 (VCC 2)

Due to continuous improvements and innovations of all ENTTEC products, specifications and features are subject to change without notice.

enttec.com

MELBOURNE AUS / LONDON UK / RALEIGH-DURHAM USA
 mfile ID: 4815382

Pixel Octo



Features

- Web configurable
- Firmware updateable
- Supports the following DMX over Ethernet protocols:
 - Art-Net
 - Streaming ACN (sACN)
 - ESP
 - KiNET
- Configurable Static or Dynamic (DHCP) IP (DHCP by default).
- Netmask and gateway updateable
- Up to 8 ethernet universes support (maximum of 4 universes per output port)
- Configurable pixel colour ordering.
- Monitors device temperature
- Monitors and displays the network traffic
- Easily extendable network - daisy chain ethernet connection up to a maximum of 50 devices
- Compatible with CLK LED Tapes
- White Pixel Order compatibility
- 35 mm DIN mountable
- Flexible wiring configurations
- Executes live effects on the fly
- Save dynamic effects created as a presets for quick access.
- User-friendly interface to create and execute live effects on the fly
- Aluminium Enclosure
- Top view indicator lights and button
- Pluggable terminal blocks
- Dual Spring 35mm DIN rail brackets

Wiring Diagrams

LEGEND

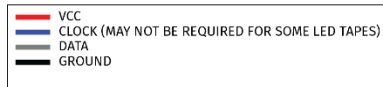

POWER CONNECTION (POWER INPUT TERMINALS)

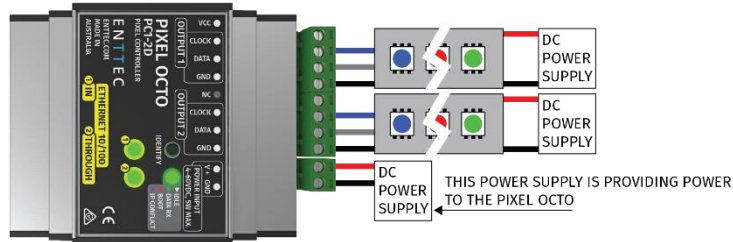

POWER CONNECTION (VCC TERMINAL)

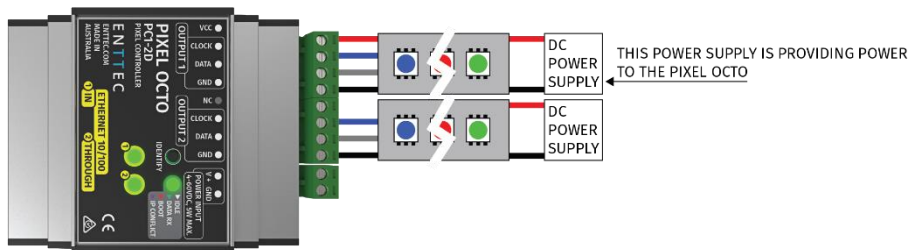

POWER CONNECTION (USING TERMINAL SPLITTERS)

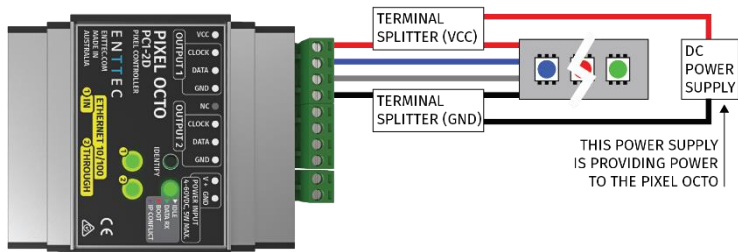

MULTIPLE LED POWER INJECTION

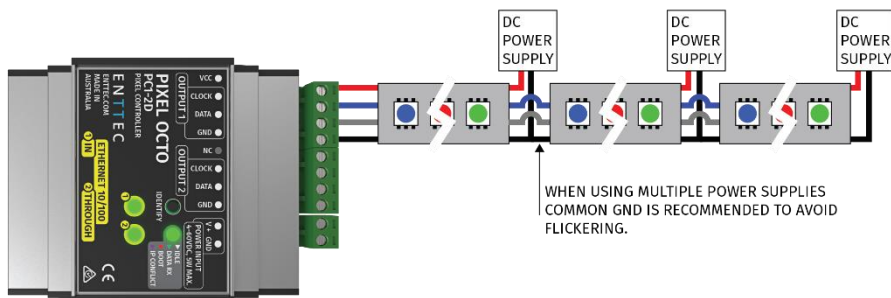

MULTIPLE LED TAPE SECTIONS

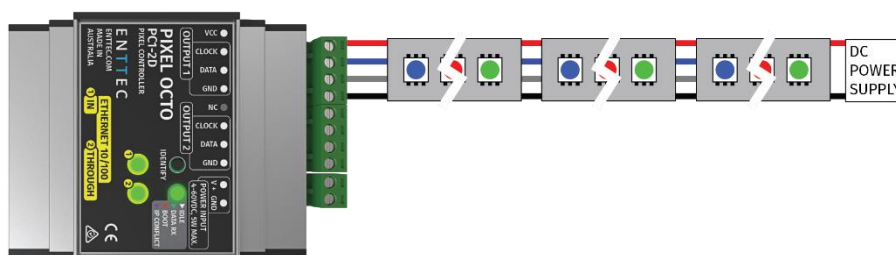

Safety

- This unit is intended for indoor use only.
- Do not expose this device to rain or moisture, doing this will void the warranty.
- Make all connections before powering on
- Do not remove the cover, there are no user serviceable components inside.
- Never plug this unit into a dimmer pack
- Ensure input voltage is within the specified limits
- Always be sure to mount this unit in an area that will allow proper ventilation.

Physical Dimensions

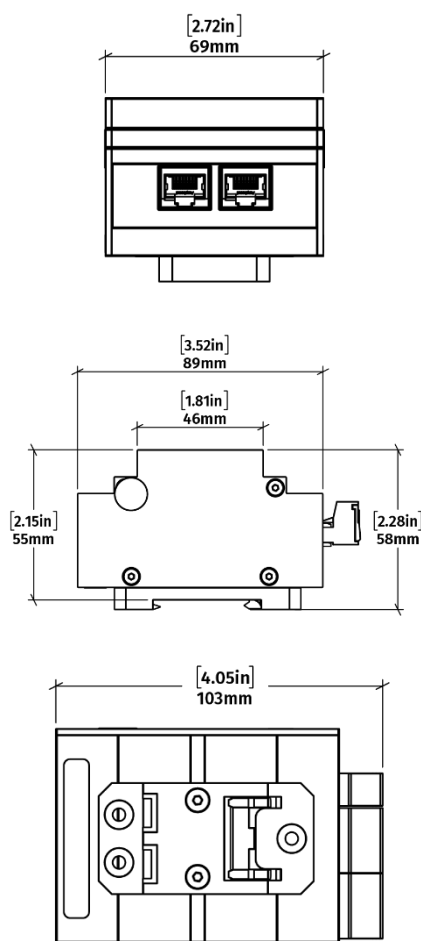

Ordering Information

Part Number	Description
71520	Pixel Octo

Specifications

Item	Specification	
Input Voltage	4-60V DC	
Maximum Power consumed	5W	
Supported Protocols	ArtNet	
	sACN	
	KiNET	
	ESP	
Output Protocols	WS2811	WS2812
	WS2812B	WS2813
	SK6812	TM1804
	TM1812	APA-104
	APA-102	9PDOT (8 – 16bit)
Maximum Pixel count/output (RGBW)	512 RGBW pixels	
Maximum Pixel count/ output (RGB)	680 RGB pixels	
Maximum DMX footprint/output	2048 channels	
Connectors	2 x 4Pin Output phoenix	
	1 X 2Pin Power In	
	2 X RJ 45	
IP Rating	IP 20	
Operating Temperature	-10 °C to 60 °C	
Relative Humidity	5- 95% (non-condensing)	
Weight of device (In kg)	0.25 kg	
Dimensions (in mm)	103 (L) x 69 (W) x 58 (H)	

Due to continuous improvements and innovations of all ENTTEC products, specifications and features are subject to change without notice.

enttec.com

MELBOURNE AUS / LONDON UK / RALEIGH-DURHAM USA