

JTS®

Hear The Future.....Now !

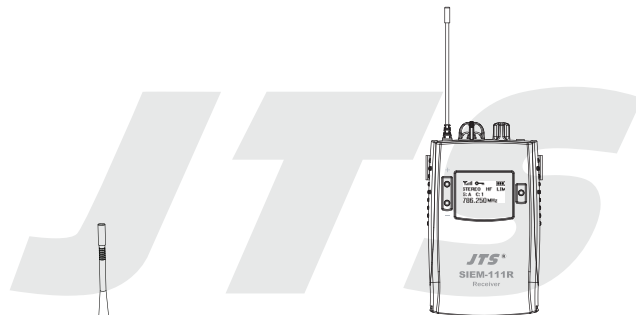

SIEM-111T/SIEM-111R

PLL Stereo/Mono In Ear Monitoring System

- Preset 961 selectable channels
- Stereo/mono

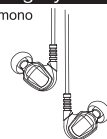
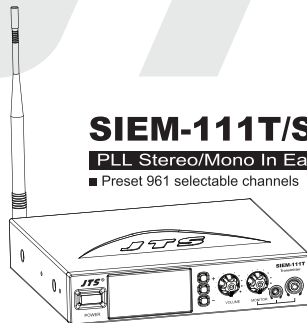

NEW! SIEM-111T/SIEM-111R can select a better earphone, **IE-5** or **IE-6** with Hi-dynamics, Hi-definition, Low-noise and Accurate audio reproduction.

RoHS
conform

FC CE 1856 ①

59508-015-02



ATTENTION

Please pay high attention to the following information.

The guideline published by Occupational Safety Health Administration (OSHA) in United States indicates overload volume level for prolonged listening may harm your hearing. Here below are referenced data on maximum time exposure to sound level before hearing injury occurs.

<u>Sound Level (dB)</u>	<u>Duration per day (hrs)</u>
90	8
92	6
95	4
97	3
100	2
102	1.5
105	1
110	0.5
115	0.25
140	Avoid or injury may occur

T ABLE OF CONTENTS

1. Important Cautions	1	5. Preparing Procedures	8
2. Features	1	5-1 SIEM-111T	
3. Specification	3	5-2 SIEM-111R	
3-1 SIEM-111T / SIEM-111R		5-3 Optional Accessory	
3-2 IE-1 (Optional Accessory)		6. Basic Operation	13
4. Parts Identification	4	6-1 SIEM-111T	
4-1 SIEM-111T		6-2 SIEM-111R	
4-2 SIEM-111R		7. Installation Assignment	21
4-3 Optional Accessory		8. Recommendations	26

Thank you for choosing the JTS in ear monitoring system. In order to obtain the best efficiency from the system, you are recommended to take few minutes to read this instruction manual carefully.

1. Important Cautions

- Make all connections before plugging the unit into an AC power outlet.
- Do not leave the devices in a place with high temperature or high humidity.
- Do not handle the power cord with wet hands.
- Keep the devices away from fire and heat sources.
- Avoid prolonged listening at overhigh volume. It may cause injury to your ears.

2. Features

- The system is based on JTS reliable UHF PLL technology.
- There are 961 selectable channels available. As many as 16 sets of SIEM-111 transmitters can work on the same stage.
- The system offers 4 groups of each 16 compatible preset channels. This allows monitor engineer to set up systems easily.
- Full metal cases on both SIEM-111T and SIEM-111R.

- Full LCD display with backlight on both SIEM-111T and SIEM-111R.
- Lock-on mode on both SIEM-111T and SIEM-111R.
- Switching power is provided on SIEM-111T. (100~240V)
- -10 dB input select switch on SIEM-111T
- Loop out connector on SIEM-111T for multiple setups with ease.
- Headphone monitor on SIEM-111T, which is convenient for engineers.
- MPX stereo Audio Transmission
- Hi frequency booster is equipped on SIEM-111R.
- Volume and balance controls are on the SIEM-111R.
- Built in dynamic limiter on SIEM-111R
- The wideband DynaDriver earphone reproduces full range of frequency, natural mids, and full highs and bass. (Optional accessory : IE-1)
- Human friendly mechanical structure of the earphone ensures long time fatigueless wearing. (Optional accessory : IE-1)

3. Specification

3-1 SIEM-111T/SIEM-111R

1. S/N ratio: 80 dB (A weighted)
2. Image rejection: 80 dB
3. Channel separation: 35 dB
4. Input level select switch: 0 dB/-10dB
5. Switching power supply: 100-240 V
6. Two pcs of AA battery with life over 12 hours
7. Net weight: SIEM-111T: 1.45kg
SIEM-111R: 0.2kg

3-2 IE-1 (Optional Accessory)

Frequency Response	10 ~ 20,000 Hz
Transducer Type	Dynamic
Impedance	16 Ω
Sensitivity (at 1 kHz)	114 dB/mW
Distortion	Less than 0.3 %
Cord Length	58"
Net Weight	6 g (cable excluded)

4. Parts Identification

4-1 SIEM-111T

Front Panel

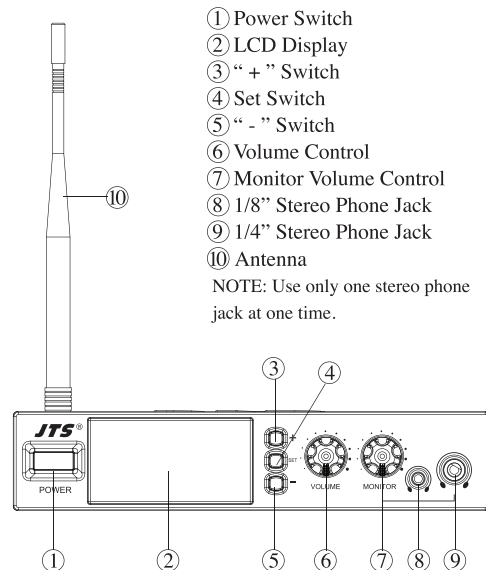

Rear Panel

- ① AC Power Socket and Fuse
- ② Balanced Loop Out Connector CH.1
- ③ Balanced Loop Out Connector CH.2
- ④ Balanced XLR/ ϕ 6.3mm Combo Input Left / CH.1
- ⑤ Balanced XLR/ ϕ 6.3mm Combo Input Right / CH.2
- ⑥ BNC Antenna Output Socket

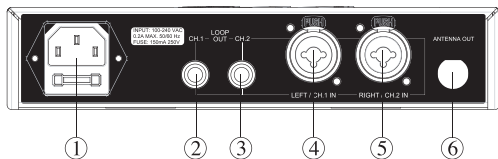

4-2 SIEM-111R

- ① Antenna
- ② Power Switch and Volume Control
- ③ Balance Control
- ④ 1/8" Stereo Phone Jack
- ⑤ LCD Display
- ⑥ "+" Switch
- ⑦ "-" Switch
- ⑧ Set Switch
- ⑨ Belt Clip
- ⑩ Battery Tray

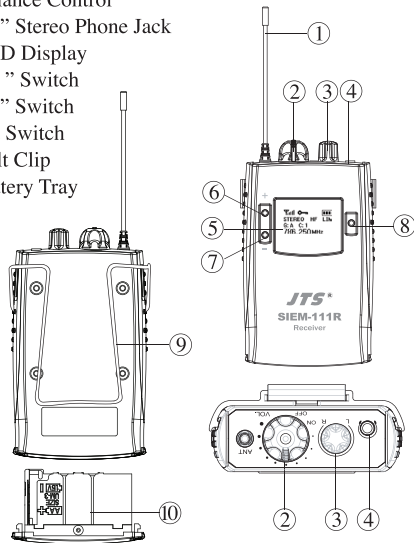

4-3 Accessory

1. IE-1

- ① Earphone
- ② Silicon Sleeve
- ③ Cord
- ④ 1/8" Stereo Phone Plug
- ⑤ Case

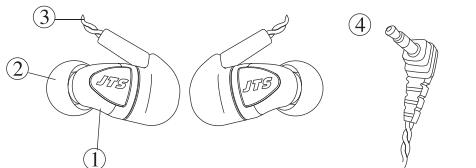

2. IE-5 / IE-6 (Optional)

3. RM-901 Rack Mount Kit

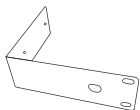

4. RTF-1 Antenna Extension Cable

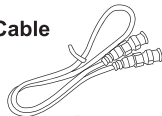

5. RTF-20 Antenna Extension Cable (20 meters)



5. Preparing Procedures

5-1 SIEM-111T

1. Set the rubber pad

Four self-adhesive rubber pads are provided to ensure the stability. They are to be placed on the bottom of the transmitter.

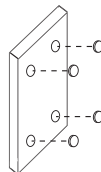

2. Attach the antenna

The user-friendly antenna comes with BNC connector. Connect the antenna on the rear of the transmitter and align it upward.



3. Connect the main unit

Connect the AC INPUT in the rear panel of SIEM-111T to an AC power socket with the supplied AC power cord.

STEP 1

4. Connect the audio source, such as a mixer.

Connect the mixer output to the XLR / ϕ 6.3mm combo input in the rear panel of SIEM-111T with the AF input cable.

STEP 2

NOTE: Two balanced XLR / ϕ 6.3mm combo inputs are provided. You may use either one input or both for a stereo source. Also, two balanced ϕ 6.3mm loop out connectors are provided for multiple systems application.

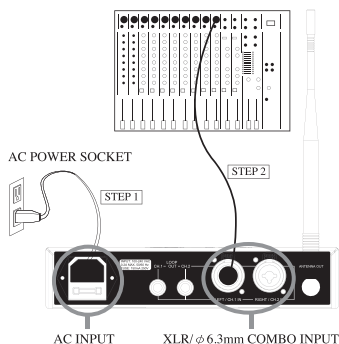

5-2 SIEM-111R

1. Insert and replace batteries

- (1) The battery tray is on the base of the receiver.
- (2) Hold both sides on the base of the receiver and release the battery tray. (Figure 1)
- (3) Upright the battery tray. (Figure 2)
- (4) Push down and slide the lid of the battery tray outward. (Figure 3)
- (5) Uncover the lid and insert two pieces of 1.5V AA batteries according to the polarity indication. (Figure 4)
- (6) Cover back the lid. Push down and slide the lid inward. (Figure 5)
- (7) Slide back the battery tray into the base of the receiver. (Figure 6)



Figure 1



Figure 2



Figure 3



Figure 4



Figure 5



Figure 6

2. Connect with the earphone IE-1

- (1) Plug the earphone into the jack of the receiver.
(Figure 1)
- (2) Make sure the volume is at low level to avoid injury to your ears.
- (3) Insert earphones into your ear at a correct position.
(Figure2)
- (4) Check if the silicon sleeve is suitable for your ear. If not, replace with other sizes of sleeves for comfort and best isolation. (Figure 3)
- (5) Make sure correct channels are chosen. The letter “R” and “L” on the earphones indicate the right and left channels respectively.

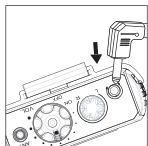

Figure 1



Figure 2

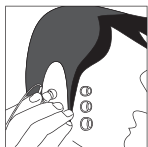
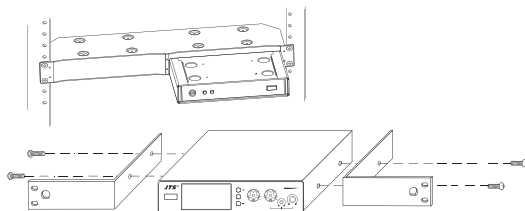

Figure 3

5-3 Optional Accessory

1. DR-900/RP-900 Rack Mount Kit

Rack mount kit is available to install the half rack transmitter into a standard EIA rack.



2. RTF-1 RTF-20 Antenna Extension Cable

Antenna extension cable enables front mounting antenna which benefits reduction of RF interference.



6. Basic Operation

6-1 SIEM-111T

1. Power On / Off

Turn on or turn off the transmitter by pressing the “POWER” button.

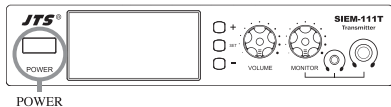

2. Volume

Adjust the volume to a proper level.

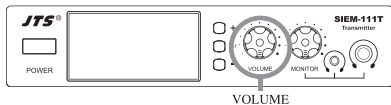

3. Monitor Volume

Adjust the monitor volume to a proper level.

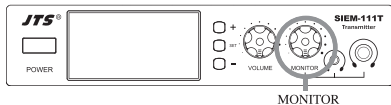

4. Setting

LCD Display

- ① AF Level of Left Channel
- ② AF Level of Right Channel
- ③ Set Frequency When Flashing
- ④ Set Group When Flashing
- ⑤ Set Mode When Flashing
- ⑥ Set Attenuation When Flashing
- ⑦ Set Lock On/Off When Flashing
- ⑧ Stereo/Mono Indicator
- ⑨ Attenuation Level
- ⑩ Group and Channel Indicator
- ⑪ Frequency

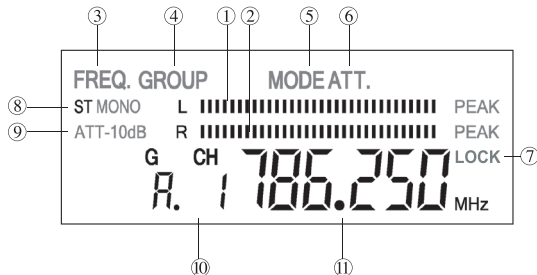

Set Frequency

- (1) Press "SET" button for about 2 seconds and then "FREQ." starts flashing on the panel.
- (2) Press "+" or "-" button to increase or decrease the frequency.
- (3) Press "SET" button again to store the frequency.



Set Group / Channel

- (1) Press "SET" button for about 2 seconds and then "FREQ." starts flashing on the panel.
- (2) Repress "SET" button and "GROUP" and "G" start flashing on the panel.
- (3) Press "+" or "-" button to increase or decrease the group number.
- (4) Press "SET" button again and "GROUP" and "CH" start flashing on the panel.
- (5) Press "+" or "-" button to increase or decrease the channel number.
- (6) Press "SET" button again to store the group and channel.



Set Stereo or Mix/Mono Mode

- (1) Press "SET" button for about 2 seconds and then "FREQ." starts flashing on the panel.
- (2) Repress "SET" button until "MODE" starts flashing on the panel.
- (3) Press "+" button to select as Stereo mode; press "-" button to select as Mix/Mono mode.
- (4) Press "SET" button again to store the stereo or mix/mono mode.



Set Attenuation

- (1) Press "SET" button for about 2 seconds and then "FREQ." starts flashing on the panel.
- (2) Repress "SET" button until "ATT." starts flashing on the panel.
- (3) Press "+" button to select as "0dB"; press "-" button to select as "-10dB."
- (4) Press "SET" button again to store the attenuation.

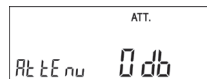

Set Lock On / Off

- (1) Press "SET" button for about 2 seconds and then "FREQ." starts flashing on the panel.
- (2) Repress "SET" button until "LOCK" starts flashing on the panel.
- (3) Press "+" button to select as "Loc ON" mode; press "-" button to select as "Loc OFF" mode.
- (4) Press "SET" button again to store the lock on / off.

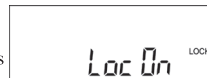

Release Lock On Mode

- (1) To release the lock on mode, press "SET" button for about 2 seconds and then "LOCK" starts flashing on the panel.
- (2) Press "-" button to release the lock on mode. Otherwise, press "+" button to remain lock on mode.
- (3) Press "SET" button to store the setting.

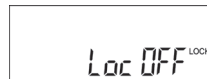

6-2 SIEM-111R

1. Power On / Off and Volume

Turn on or off the receiver and adjust the volume by rotating the volume control clockwise and reversely.

*NOTE: Please turn off the receiver before replacing batteries to ensure all functions normal.

2. Balance Control

In stereo mode, this controls left and right balance. In Mix mode, this controls the relative volume of the two inputs.

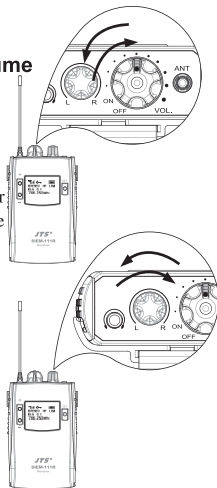

3. Setting LCD Display

- ① RF Signal Strength Indicator
- ② Lock On Mode
- ③ Battery Fuel Gauge
- ④ Audio Mode (Stereo / Mono)
- ⑤ High Frequency Booster
- ⑥ Dynamic Limiter
- ⑦ Group and Channel
- ⑧ Mute Indicator
- ⑨ Frequency

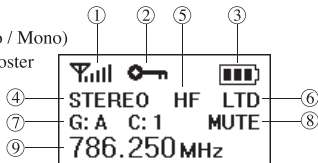

*Press "SET" button, the menu will display on the panel.

Set Frequency

- (1) Press "+" or "-" button to select "1. Frequency" and press "SET" button.
- (2) Press "+" or "-" button to increase or decrease the frequency.
- (3) Press "SET" button again to store the frequency.

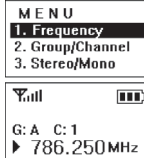

Set Group / Channel

- (1) Press "+" or "-" button to select "2. Group / Channel" and press "SET" button.
- (2) Press "+" or "-" button to increase or decrease the group number.
- (3) Repress "SET" button and then press "+" or "-" to increase or decrease the channel number.
- (4) Press "SET" button again to store the group and channel.

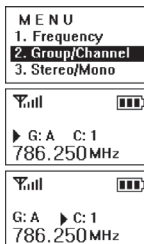

Set Stereo or Mix/Mono Mode

- (1) Press "+" or "-" button to select "3. Stereo / Mono" and press "SET" button.
- (2) Press "+" button to select as stereo mode; press "-" button to select as mix/mono mode.
- (3) Press "SET" button again to store the stereo or mix/mono mode.

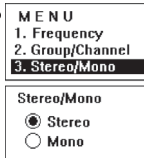

Set Hi Frequency Booster

- (1) Press “+” or “-” button to select “4.Hi Freq. Boost” and press “SET” button.
- (2) Press “+” button to turn on the booster; press “-” button to turn off the booster.
- (3) Press “SET” button again to store the hi frequency booster.

M E N U
4. Hi Freq. Boost
5. Limiter
6. Key lock

Hi Freq. Boost
 ON
 OFF

Set Dynamic Limiter

- (1) Press “+” or “-” button to select “5. Limiter” and press “SET” button.
- (2) Press “+” button to turn on the limiter; press “-” button to turn off the limiter.
- (3) Press “SET” button again to store the dynamic limiter.

M E N U
4. Hi Freq. Boost
5. Limiter
6. Key lock

Limiter
 ON
 OFF

Set Keypad Lock On / Off

- (1) Press “+” or “-” button to select “6.Key lock” and press “SET” button.
- (2) Press “+” button to lock on; press “-” button to lock off.
- (3) Press “SET” button again to store the keypad lock on / off mode.

M E N U
4. Hi Freq. Boost
5. Limiter
6. Key lock

Key lock
 ON
 OFF

Release Lock On Mode

To release the lock on mode, press “SET” button and then press “+” button. Otherwise, press “-” to keep lock on mode.

Unlock keypad?
[+] Yes / [] No

Adjust LCD Contrast

- (1) Press “+” or “-” button to select “7. Contrast” and press “SET” button.
- (2) Press “+” or “-” button to increase or decrease the contrast.
- (3) Press “SET” button again to store the contrast setting.

M E N U
7. Contrast
8. Light time
9. Exit

Contrast

Set Backlight Time

- (1) Press “+” or “-” button to select “8.Light time” and press “SET” button.
 - (2) Press “+” or “-” button to increase or decrease the backlight time. Eight selections are provided: Off, 1 sec., 2secs., 5 secs., 10 secs., 20 secs., 30 secs., and On.
 - (3) Press “SET” button again to store the backlight setting.
- NOTE: Set the backlight to always “On” will drain your battery more quickly than always “Off.”

M E N U
7. Contrast
8. Light time
9. Exit

Light time

Exit the Menu

- (1) Press “+” or “-” button to select “9.Exit” and press “SET” button to exit the menu.

M E N U
7. Contrast
8. Light time
9. Exit

7 • Installation Assignment

Here are some basic operation modes for your reference. Also, you may make use of the loop out connectors for multiple systems application.

7-1 Basic Operation

1. Stereo

Set up the installation when two outputs from the mixer are left and right channels of a stereo mix. The left channel goes to the left ear, while the right channel goes to the right ear. Adjust the volume by using the balance control on the SIEM-111R.

1. Connect the mixer outputs to the transmitter inputs.
2. Set SIEM-111 T to Stereo mode. (See 6-1)
3. Set SIEM-111 R to Stereo mode. (See 6-2)

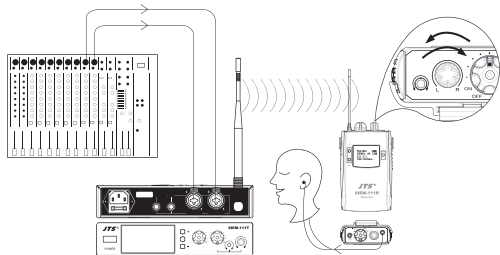

2. Mix

Set up the installation when two outputs from the mixer are different mono mixes that go to both left and right earphones. Make one mix louder than the other by using the balance control on the SIEM-111R. The total volume keeps at the same level in both ears.

1. Connect the mixer outputs to the transmitter inputs.
2. Set SIEM-111 T to Stereo mode. (See 6-1)
3. Set SIEM-111 R to Mix/Mono mode. (See 6-2)

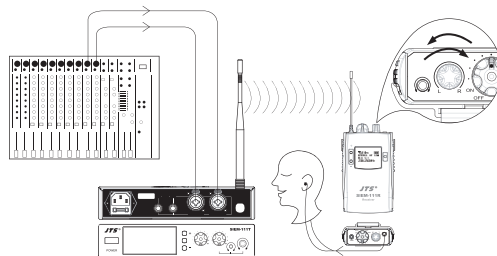

3. Mono

Set up the installation when only one output from the mixer.

1. Connect the mixer output to the transmitter input. (Either LEFT/CH.1 or RIGHT/CH.2)
2. Set SIEM-111T to Mix/Mono mode. (See 6-1)

NOTE: Stereo or Mix/Mono mode of SIEM-111R will be no effect in this setup.

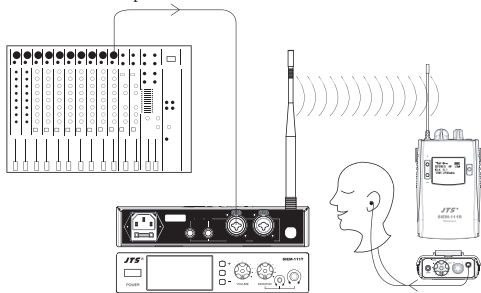

1. Connect the mixer outputs to inputs of the first transmitter.
2. Connect loop out connectors of the first transmitter to the second one.
3. Connect subsequent systems in the same way.

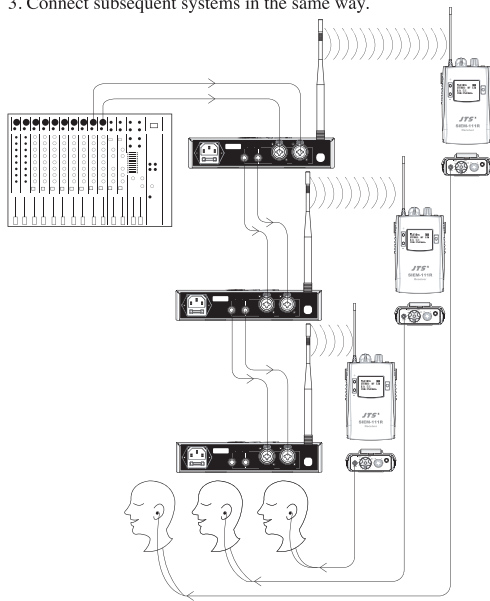

7-2 Loop Out Application

1. Stereo for Multiple Systems

Make use of the loop out connectors to deliver one stereo signal from the mixer to multiple SIEM-111T.

2.Mix For Multiple Systems

This installation enables each performer to create their own mix.

1. Send the band mix to input (Right / CH.2) of the first transmitter.
2. Connect loop out connector (CH.2) of the first transmitter to input (Right/CH.2) of the second transmitter.
3. Connect individual solo mix to input (Left/CH.1) of each performer's transmitter.

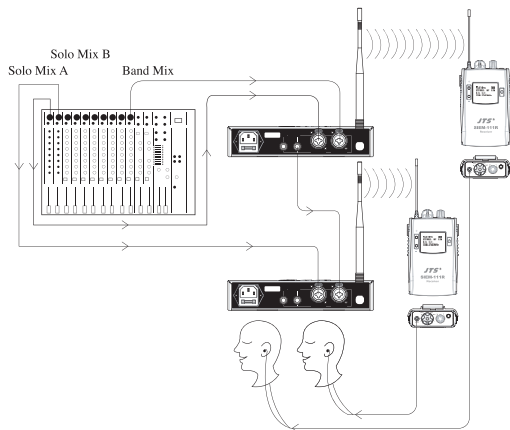

8. Recommendations

1. In order to achieve the optimum reception condition and also extend the operating distance, please leave an open space between the receiver and transmitter.
2. Keep the devices away from the metal objects or any interference sources, at least 50 cm.
3. Remove batteries from the battery compartment when the receiver will not be used for long time.
4. When you need to replace the batteries, please replace both batteries at the same time with new ones.