

ionic-50 ionic-12S

QUICK START GUIDE

V.17.12

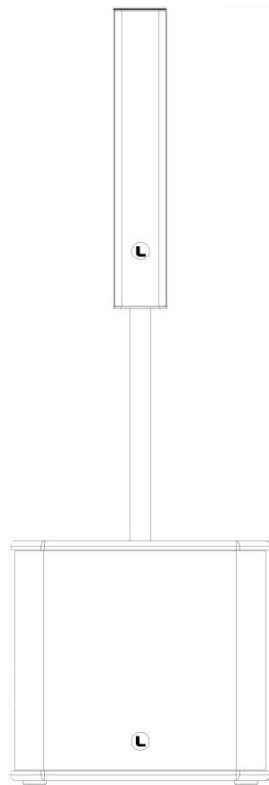

Lynx Pro Audio S.L.

Valencia, Spain - www.lynxproaudio.com - info@lynxproaudio.com

ionic-50



ionic-12S



Manufacturer



**LYNX Pro Audio S.L.
Calle uno - Pol. Ind. Picassent
E-46220 Picassent (Valencia)**



CE CERTIFICATION, EUROPEAN PRODUCT

This user guide is property of Lynx Pro Audio S.L. Any reproduction of this manual, by any means is strictly prohibited.

Copyright 2017. All rights reserved.

CONTENTS

- SAFETY PRECAUTIONS	4
- INTRODUCTION	5
- SYSTEM OVERVIEW	
COLUMN SPEAKER IONIC-50	6
SUBWOOFER IONIC-12S	7
- SIGNAL AND CONTROL	
BACK PANEL	8
CONNECTORS AND CONNECTIONS	9
ACOUSTIC CENTRE	10
- CONNECTION EXAMPLES	11
- CONFIGURING THE CABINET DSP OPTIONS	
CONFIGURATION PANEL	14
SELECT THE INPUT DIGITAL / ANALOG	15
SELECT AND RUN PRESET	15
- WALL INSTALATION AND ACCESSORIES	16
- ONLINE CONTROL SYSTEM	17
- CERTIFICATIONS AND GUARANTEE	18

Before starting to use this device, please read this instruction manual carefully.
Keep these instructions in the place where the equipment will be used and with easy access to them.

- Electrical appliance.



The exclamation mark within a triangle identifies the presence of electricity. Use the system carefully without wet hands or feet. Avoid installing the speaker in wet or excessively humid places. Do not place material that contains liquid on or near the unit. Avoid dripping or splashing water or any liquid over the unit. Regularly check the condition of the cables and make sure these are not being walked on or pinched. Connect the speaker to bipolar, earthed mains. The mains plug must be connected to the appropriate protection (fuse or breaker). Connection to any other type of mains could result in an electrical shock and violate local electrical codes. **CAUTION: DO NOT CONNECT OR DISCONNECT THE AC POWER CONNECTORS UNDER LOAD.**

- Heavy equipment.



Apply back protection when using the system. Avoid loading and unloading at heights.

- Electrical shock risk.



The diagonal mark within a triangle identifies the presence of dangerous voltage. Do not open or handle the interior of the box. These parts are not to be adjusted by the user. For maintenance and/or repair please go to an authorized service centre. In order to reduce the risk of electric shock, disconnect from AC before plug in or unplugging Audio signal cables. Reconnect to AC only if all signal connections are made and secured. Never manipulate the ground type plug provided. The AC mains plugs should always remain accessible for operation. Unplug the loudspeaker during storms or when it's being used for a long time.

- Hearing damage risk.



These systems can reproduce large quantities of sound pressure which can damage hearing. Take precautions if you are going to be near them for extended amounts of time and do not get too close.

- Hanging – Flying.



Do not hang the cabinets from the handles or from any other part other than the designated hanging point. When flying this system please observe the technical and "Rainbow" software data carefully. Never exceed the maximum safe working loads or ignore the instructions included within this manual. Use Only flying accessories provided by Lynx Pro Audio S.L. Rigging must be always carried out by professionals.

- Delicate Material.



Please ensure no foreign object or water enters the speaker. Only clean the unit with dry cloths. Do not use solvents.

-Overheating – Fire risk.



To reduce the risk of the speaker over heating, avoid direct contact with sunlight. Avoid placing the unit close to heat inducing objects such as radiators. Do not cover the equipment in use and do not block any ventilation openings. Do not put naked flame, such as lighted candles, close or on top of the unit.

- Electromagnetic and intereferente emissions.



Avoid placing objects which through electromagnetic waves can damage the unit, such as mobile phones, lap tops, magnetic strip cards etc.

This system complies with normatives

EN 55103-1 (1)

EN 55103-2 (2)

(1) This device may not cause harmful interferences.

(2) This device may receive interference including interferences that may cause undesired working.

-IMPORTANT NOTE.



This Equipment must be used in accordance with these instructions and by trained professional personnel only. This equipment should not be used in places with extreme tropical climates. Don't expose this apparatus to extreme humidity and or temperature values.

INTRODUCTION

This manual describes the recommended installation procedure for the ionic-50 in combination with the subwoofers ionic-12S.

The ionic series is Lynx Pro Audio's answer to light, portable and permanent column speakers. The ionic series comprise two full-range modular columns (ionic-100 and ionic-50) and two subwoofers (ionic-18S and ionic-12S).

The columns are very low profile, versatile, aesthetically pleasing and are designed for reverberant installations where intelligible, clear voice reproduction is paramount and where a low profile, discreet column is required. They are very easy to install and can be done so either horizontally or vertically.

The full range columns can be powered from the active subwoofers and also offer various preset configurations from the integrated DSP.

Please note that a wide range of mounting accessories is available.

COLUMN SPEAKER OVERVIEW

ionic-50

Components	6 x 3" speaker with 0.75" voice coil	Rated power (AES)	150 W, 300 W program, 600 W peak
		Nominal Impedance	32 Ohms
Frequency Range	150 Hz – 20 KHz (-10dB)	Connectors	2 x Neutrik Speakon NL4MP
Frequency Response	180 Hz - 20 KHz (± 3dB)	Finish	Epoxy paint
Sensitivity	97 dB (1W@1m)	Material	1.5 mm stainless steel
Max. SPL	119 dB - 125 dB peak	Dimensions	502 x 89 x 117 mm (H x W x D)
Coverage	15° +/- 5° V x 100° H	Weight	7 Kg (15 lbs)

Column measurements

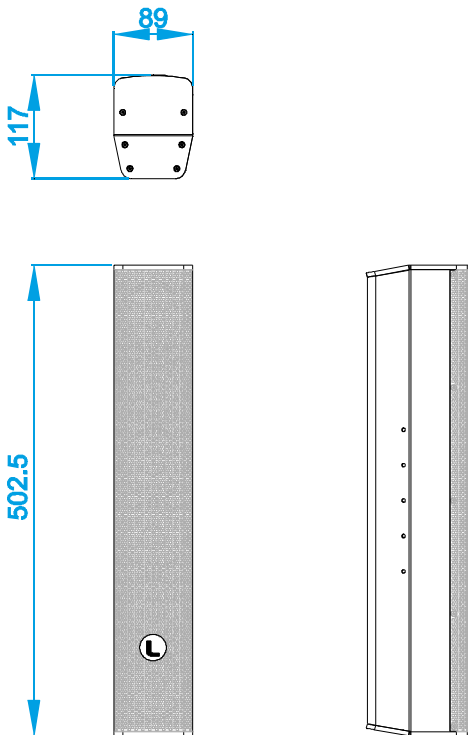

Column back panel

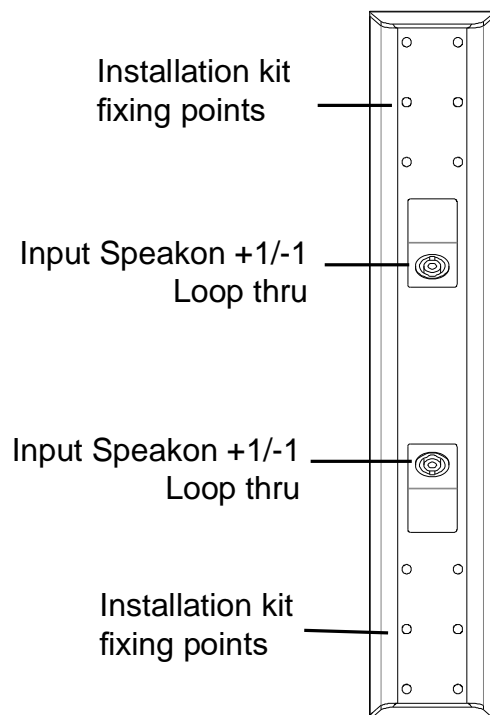

SUBWOOFER OVERVIEW

ionic-12S

Components	1 x 12" speaker with 3" voice coil	Processing	48 KHz / 56 bit double precision DSP
		Control	User control interface with LCD
Frequency Range	40 Hz – 250 Hz (-10dB)	Control Connections	Ethernet (OCS) optional / USB (DSP programming)
Frequency Response	46 Hz – 250 Hz (± 3dB)	AC Power	85 – 270V. 50/60 Hz with PFC
Max. SPL	127 dB	AC Connections	16A Neutrik powerCon TRUE1 with looping output
Coverage Angle	Omnidirectional	Finish	High resistant water-based paint
Power	1400 W Class D with switching power supply & PFC	Material	15mm Premium birch plywood
LF Amplifier	1 x 700 W	Dimensions (H x W x D)	407 x 440 x 520 mm
Speaker Output Amplifier	1 x 1700 W @ 8 Ohms	Weight	23 Kg (50.6 lbs)

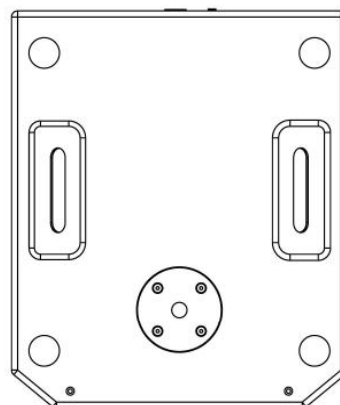
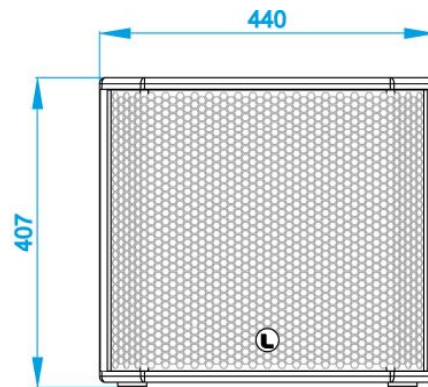
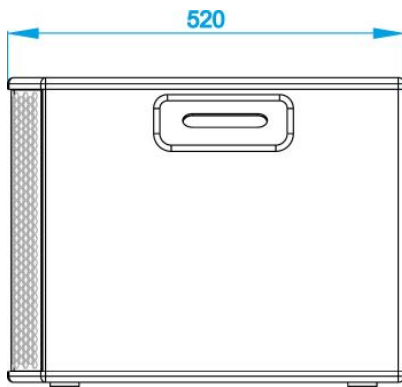

BACK PANEL

The ionic-50 columns are powered from the active subwoofers ionic-12S. In the following drawing you can see the back panel of the ionic-12S, which includes the power amplifications and the digital signal control board.

From the sub unit back panel you can also select various preset configurations using the LCD display and digital control buttons. You can see how to configure the cabinet DSP options on page 14.

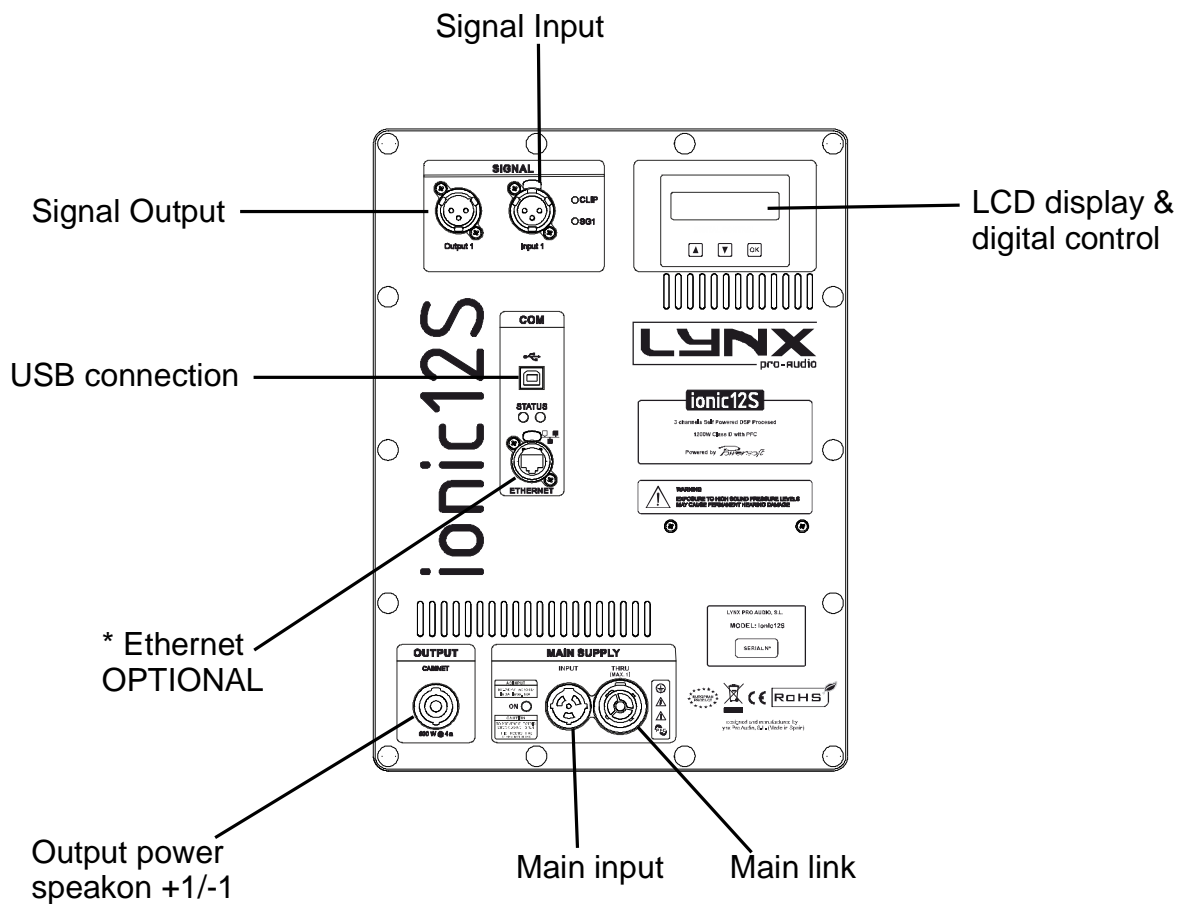

* Available when the user has requested the cabinets to be supplied with the Ethernet Module kit.

SIGNAL AND CONTROL CONNECTORS

SOCKET POWERCON TRUE1

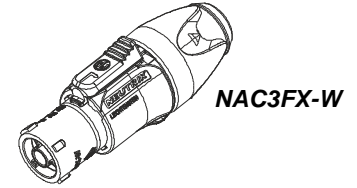
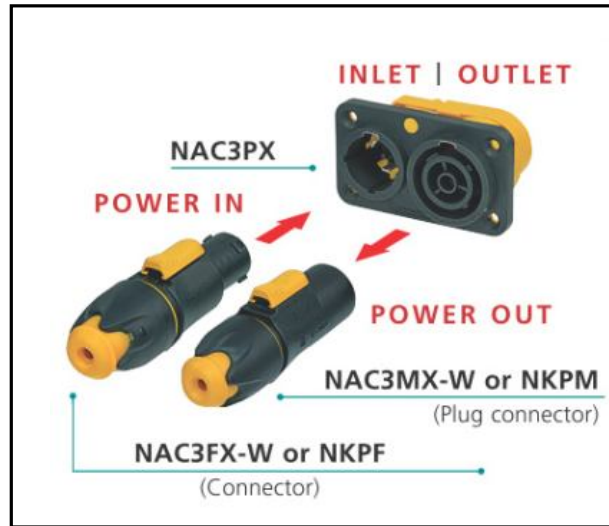
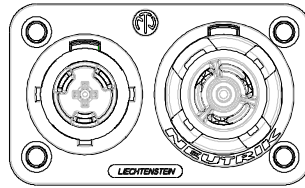

NAC3FX-W

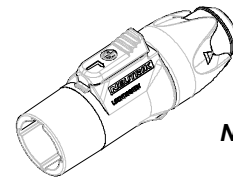

NAC3MX-W

XLR SOCKET CONNECTORS

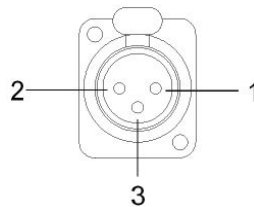

- INPUTS**
 1.- EARTH
 2.- LIVE (+)
 3.- LIVE (-)

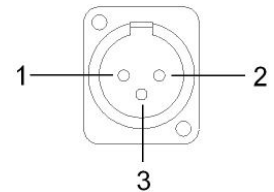

XLR AERIAL CONNECTORS

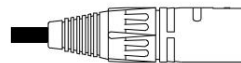

Connect to input

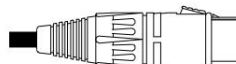
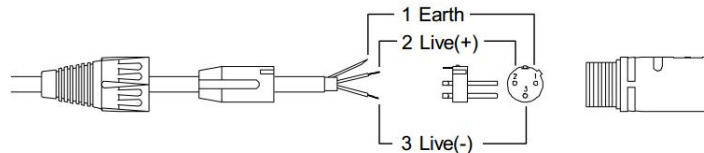

Connect to output

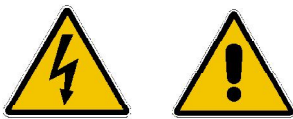
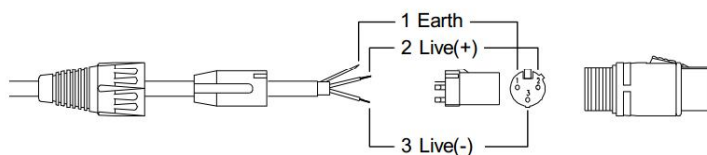

CAUTION: Do not connect or disconnect the AC Power connectors under load.

ACOUSTIC CENTRE

When mounting an ionic column is essential to understand that the height of the unit above the floor level is extremely critical. The correct operational height is the height of the ionic's "acoustic centre". The acoustic centre of the ionic-50 is located between the four speakers of the top.

When two ionic-50 columns have to be used to form one column then the upper column must be placed upside down, so its acoustic centre is in touch with the acoustic centre of the above cabinet. Note that the Lynx round logo indicates which way is up, so you can see when a column is upside down, when you see that the round logo of the cabinet is at the top of the column, and the L is inverted.

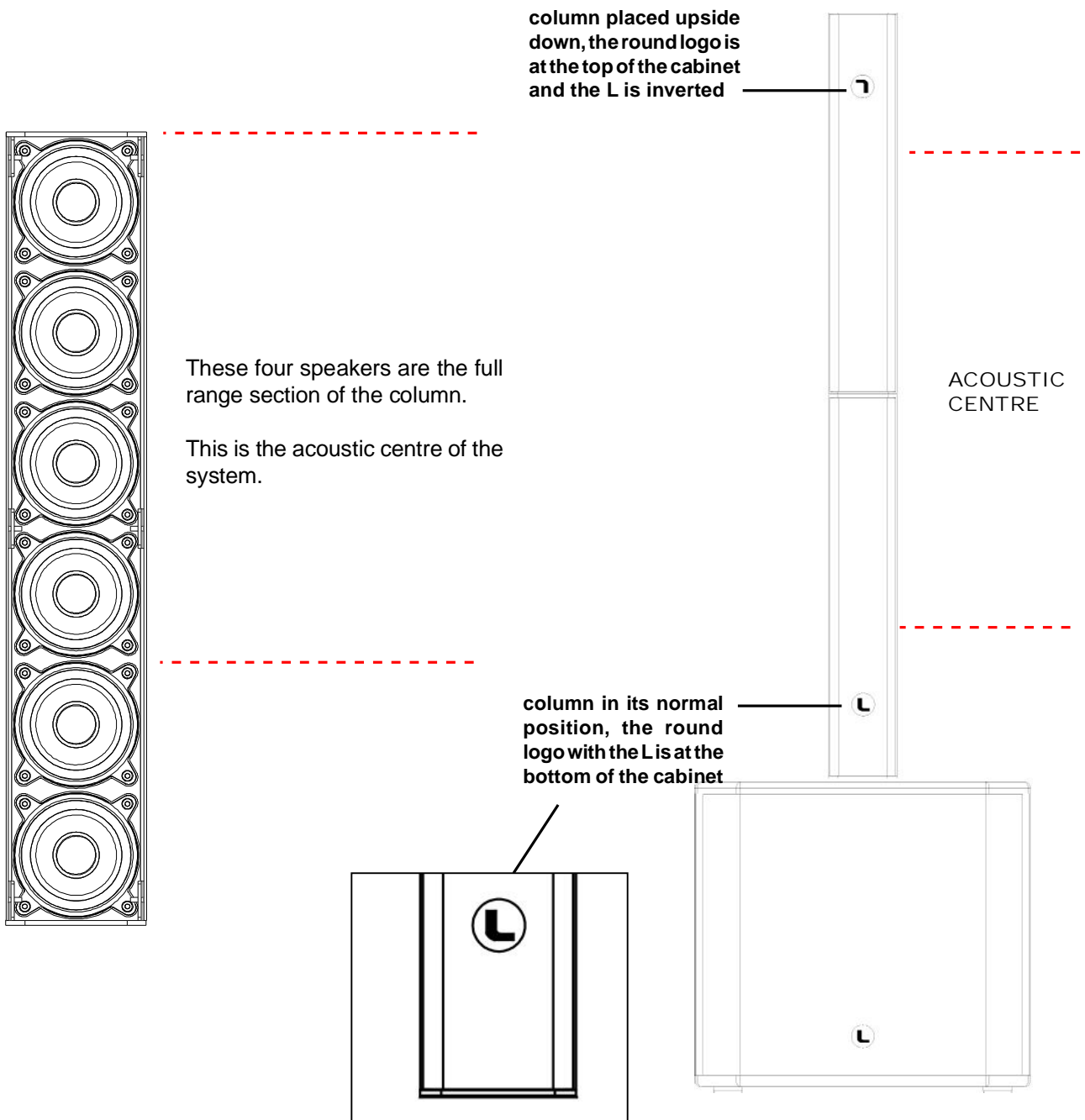

CONNECTION EXAMPLE (mono channel)

ionic-50 + ionic-12S

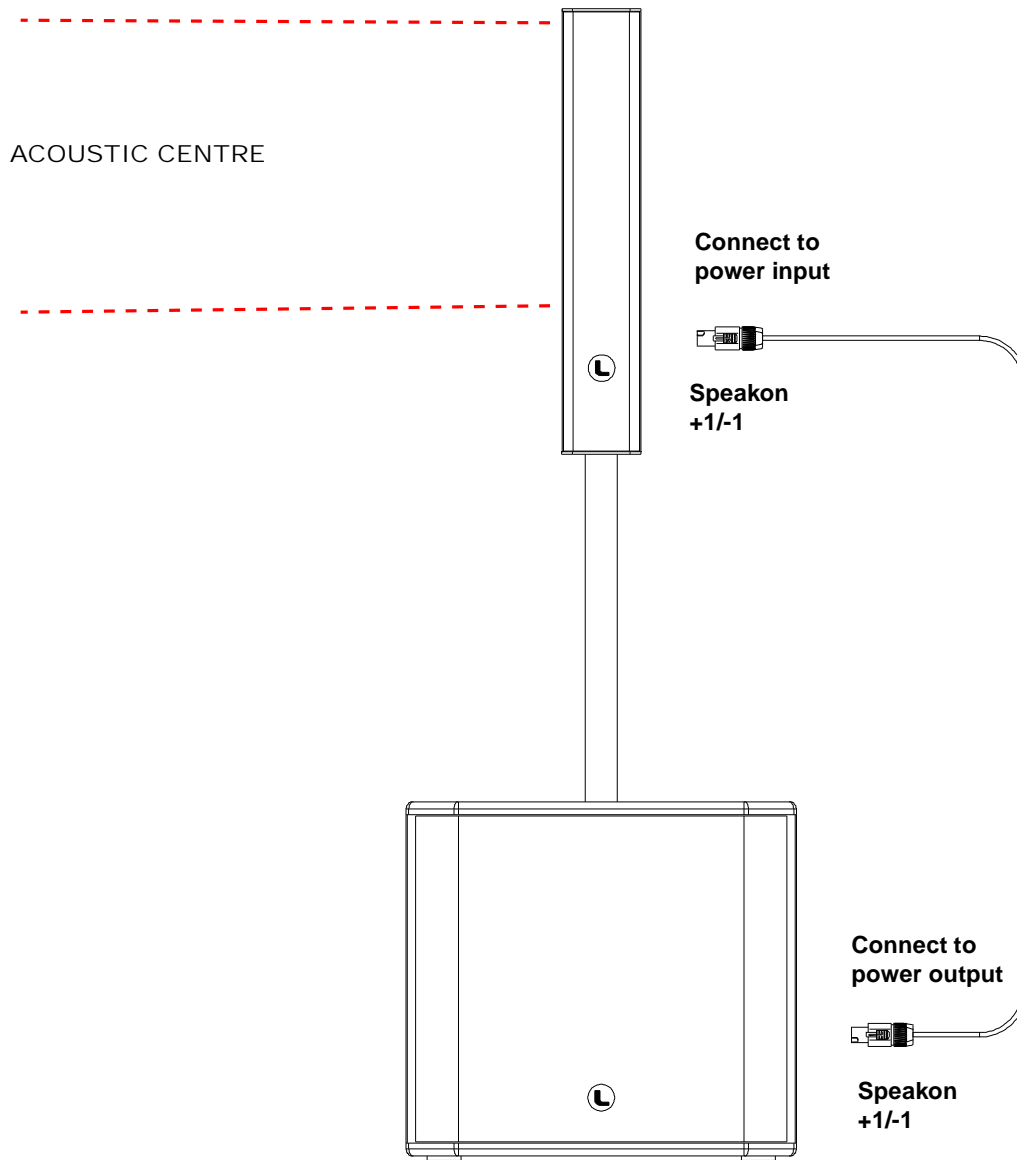

CONNECTION EXAMPLE (mono channel)

two ionic-50 + one ionic-12S

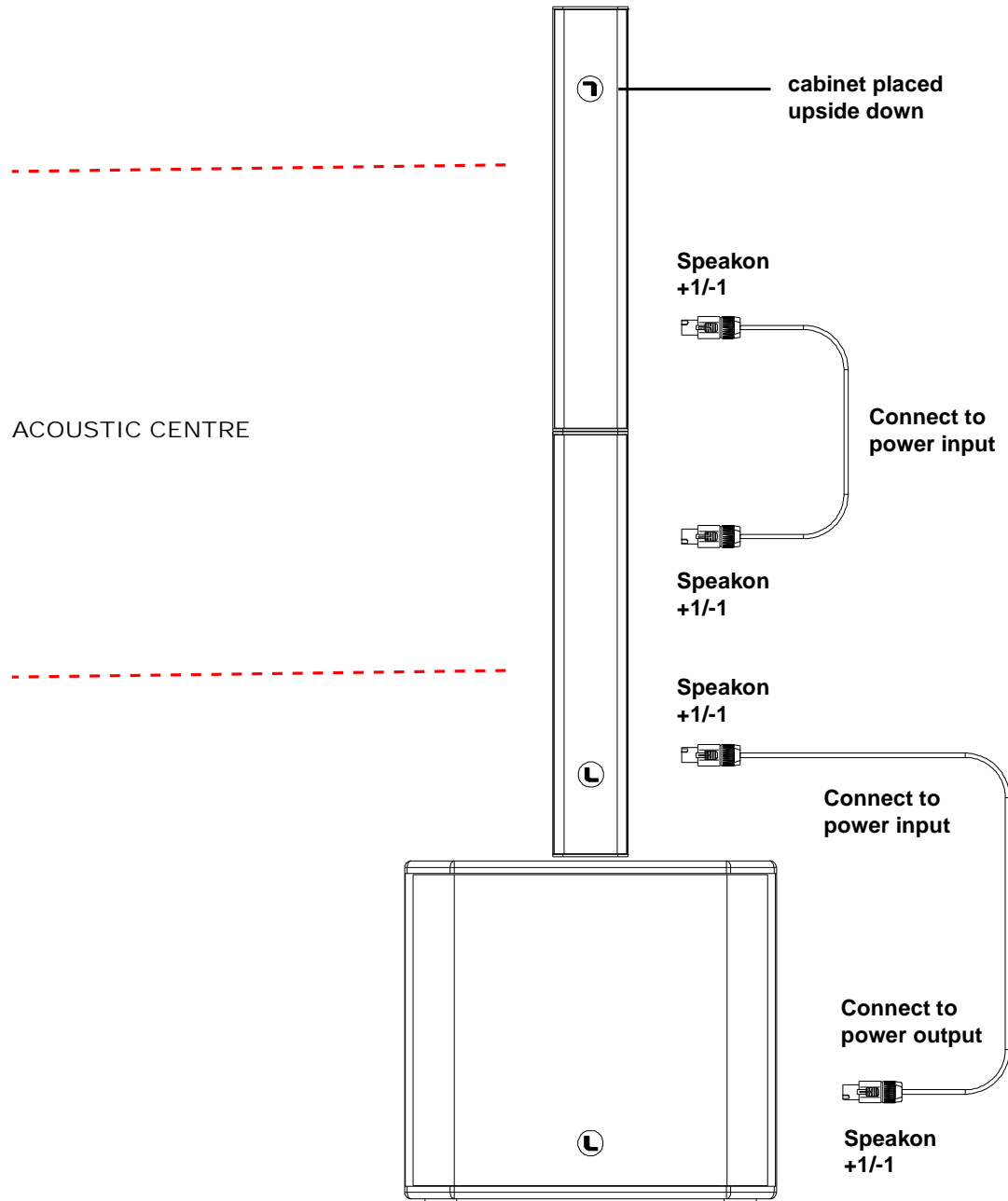

CONNECTION EXAMPLE (mono channel)

4 ionic-50 + 1 ionic-12S

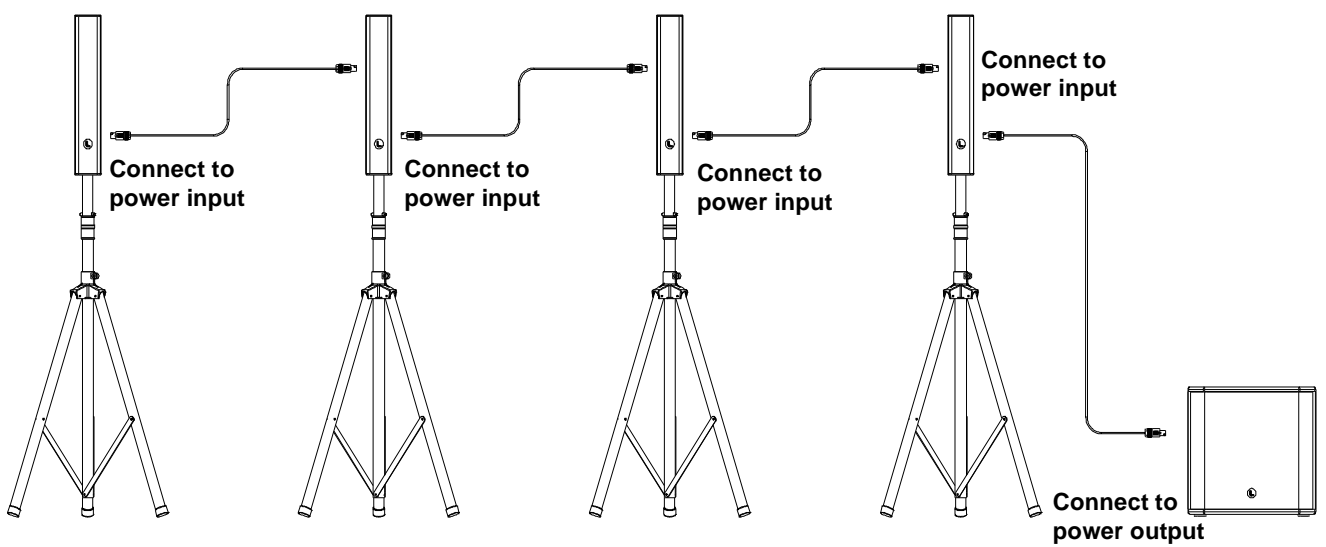

CONFIGURATION PANEL

On the subwoofer ionic-12S back panel you will see 3 buttons and an information screen, on which you can read the established parameters and information such as amplification module temperature, input signal level and name of the current preset (Fig1). If changes are not made the display will automatically dim to save energy and avoid unnecessary light in situations where light is not wanted. To re-activate the light simply press the OK button.



Fig 1

From the buttons below the display you can change the preset or select the input digital or analog. You can see how to proceed on next page.

For ionic systems you can find different preset configurations in mono and stereo.

You can change the EQ of any preset but this change will not be saved in the preset, therefore as soon as you change preset the EQ will be restarted. For example, if you want to use PRESET 1 but you prefer to change the EQ, you connect the cabinet to your computer via USB or Ethernet and introduce the EQ changes using the Online Control System software. Then you will be able to use your own EQ in PRESET 1 day after day only if you don't change to another preset. Once you change the preset the DSP restarts with the manufacturer settings. So if you change from PRESET 1 to PRESET 2 and then come back to PRESET 1 you will find that the PRESET 1 has the manufacturer's EQ again.

Note:

You must apply the desired configuration in each ionic-18S cabinet and requires electrical power to work.

SELECT THE INPUT: DIGITAL OR ANALOG

This selection is only available when the user has requested the cabinets to be supplied with the Digital input kit. There are four input options: Analog / Digital L / Digital R / Digital L+R

To select the input mode just press the OK button (3) and the up button (1), both at the same time but pressing the OK button first. Then you can select one of the four options using the up button (1).

To confirm your selection press OK (3) until the progress bar finishes.

The display will show an inverted D (digital) or an inverted A (analog) so you can always know if the input is digital or analog.

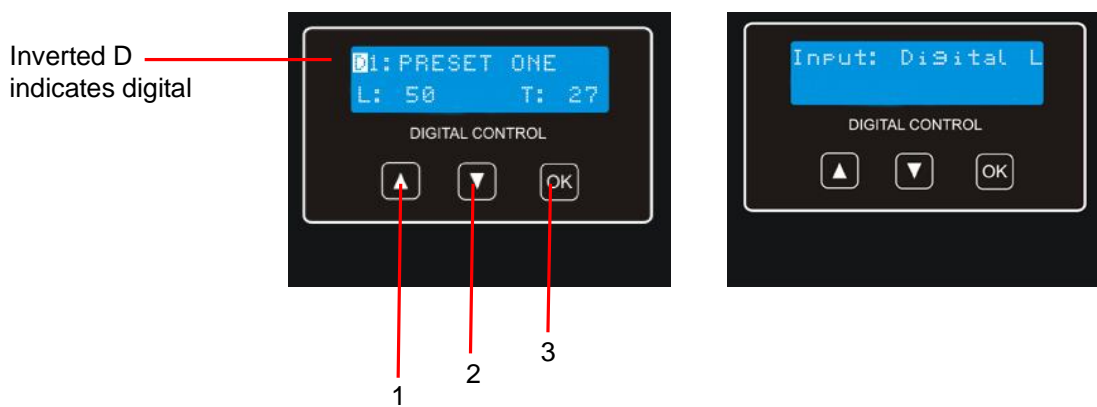

SELECT AND RUN PRESET

To change the preset configuration (see Fig 2) just press the up button (1) and down button (2) until you see the title and preset number required and once found press OK (3) until the progress bar finishes (Fig 3). The display will indicate "Loading DSP" (Fig 4)

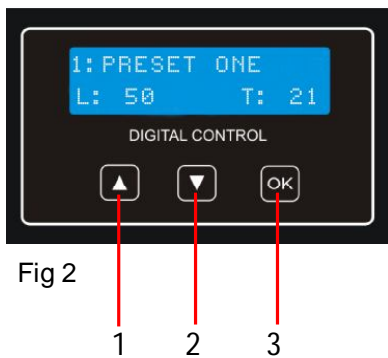

Note:

In case of a power cut, the DSP will save its last configuration when restarted.

WALL INSTALLATION

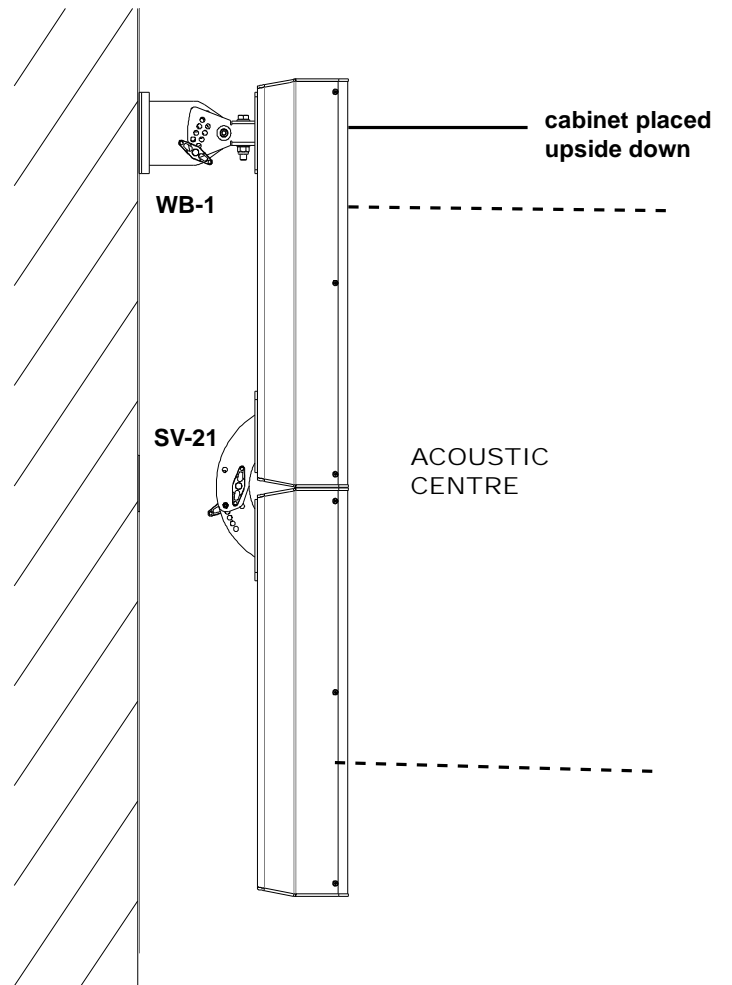
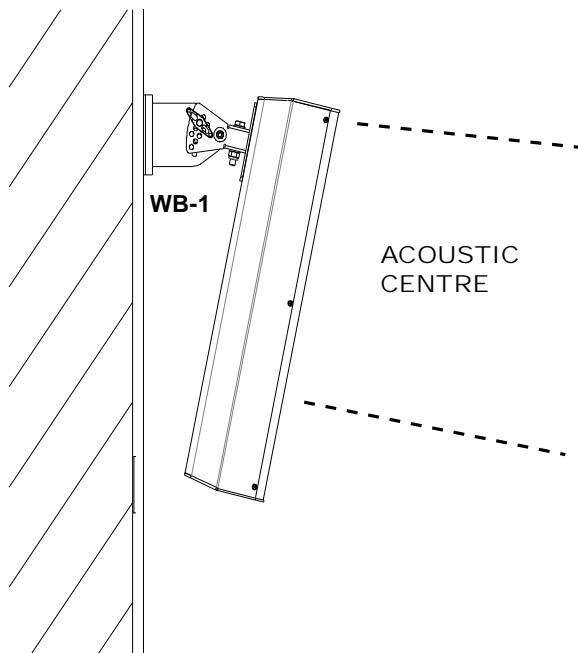

APPLICATIONS

Clubs, theatres, museums, houses of worship, public buildings, commercial complex, and intelligible applications

ACCESSORIES

SV-12S
sub adaptor for satellite



WB-1
wall bracket



SV-21
cabinet connection



SV-IONIC
steel flying frame



ONLINE CONTROL SYSTEM

Who is it for?

Users of Self powered DSP incorporated Lynx Pro Audio Cabinets where the user has requested the cabinets be supplied with the Ethernet Module kit.

What is it for?

Obtain detailed information of cabinet behaviour and monitor the cabinet/s in real time. You can change the preset, gain, mute, polarity and phase. You can also activate the air absorption compensation and select the «SOLO» mode.

How does it work?

Via Ethernet (cable or wireless). Once installed, the O.C.S. software automatically detects all the cabinets connected to the network and displays them in the O.C.S. window on the users PC.

What does it show?

As well as displaying the cabinet model and IP address the O.C.S will be monitoring in real time and the user will be able to view RMS levels, Input clip, power module temperature, compression levels, air absorption compensation and cabinet angulation.

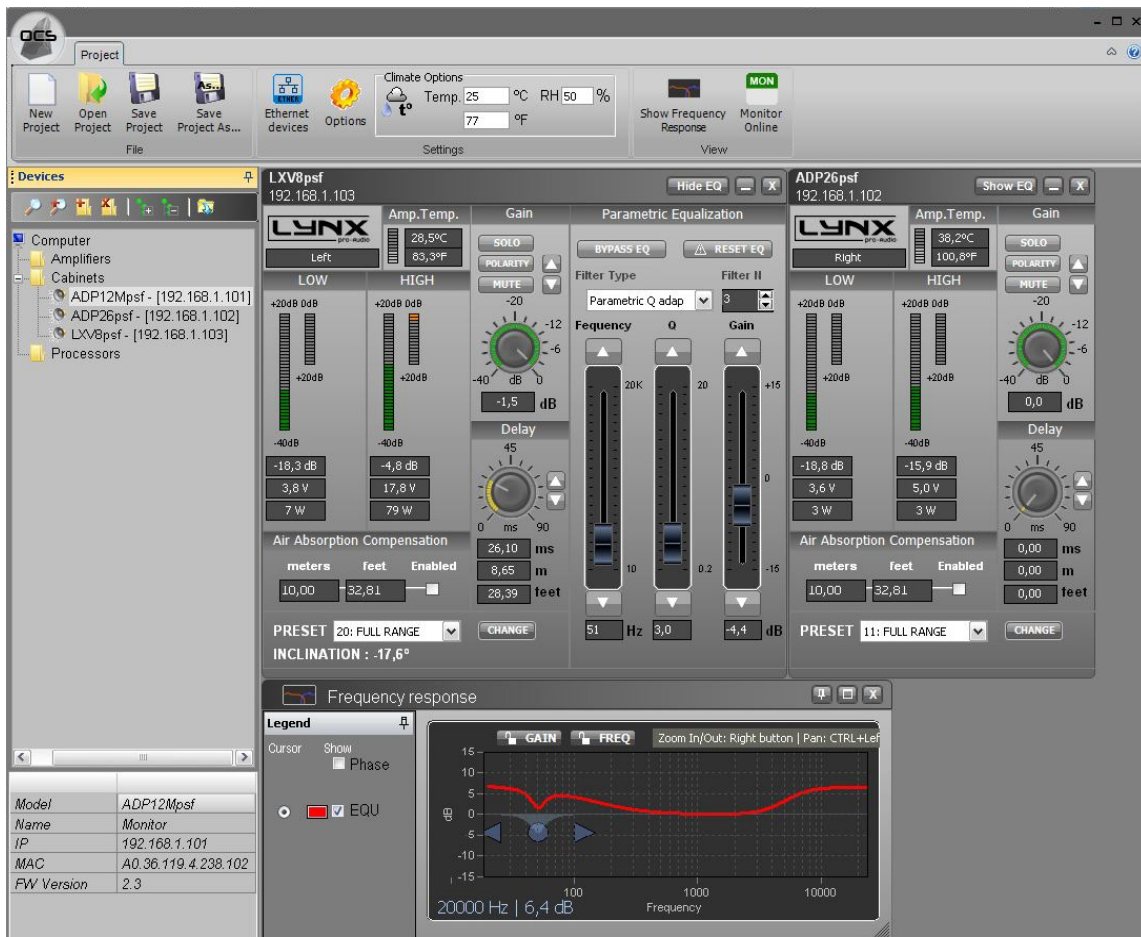

**DECLARATION OF CONFORMITY**

LYNX Pro Audio S.L.
Calle 1 - Pol. Ind. Picassent
46220 Picassent (Valencia)
SPAIN - EU
Tel.: (+34) 961 10 96 01
www.lynxproaudio.com

Lynx Pro Audio S.L. declares that ionic series are in conformity with the following EC directives:

Low Voltage Directive	2006/95/EC
Electromagnetic Compatibility EMC	2004/108/EC
RoHS Directive	2002/95/EC

In accordance with Harmonized European Norms:

EN 60065:2002	Audio, video and similar electronic apparatus. Safety requirements
EN 55103-1:1996	Electromagnetic compatibility. Product family standard for audio, video, audiovisual and entertainment lighting control apparatus for professional use. Part 1: Emission.
EN 55103-2:1996	Electromagnetic compatibility. Product family standard for audio, video, audiovisual and entertainment lighting control apparatus for professional use. Part 2: Immunity.
ionic models:	ionic-50 / ionic-100 / ionic-18S / ionic-12S

LYNX PRO AUDIO GUARANTEE

Lynx products are guaranteed against every kind of manufacturing fault 2 year after the date of sale. When products are under guarantee, the repairing and the free supplying of the device parts in order to correct any kind of defect are guaranteed by Lynx Pro Audio S.L. In the case that the product could not be returned to the factory for checking and repairing, Lynx Pro Audio S.L. would supply all the necessary parts.

Lynx Pro Audio S.L. is not responsible for any damage or defect caused during the transport or caused by an undue or improper handling y a non-authorized person during the life of this guarantee.

All our products undergo rigorous tests and quality controls. We guarantee the characteristics described here within and their quality against any fabrication defect.

The user loses all warranty rights if he incorporates or carries out any modification to the product, if he uses it outside of the stated safe working loads or does not secure the system properly using all the pins in their corresponding holes.

WEEE Declaration: Electrical and electronic equipment must be disposed of separately from normal waste at the end of its operational lifetime. Please dispose of this product according to the respective national regulations or contractual agreements. If there are any further questions concerning the disposal of this product please contact Lynx Pro Audio S.L.