

# **APIX6T**



## ASSEMBLY INSTRUCTIONS

All rights reserved by Music & Lights S.r.l. No part of this instruction manual may be reproduced in any form or by any means for any commercial use.

In order to improve the quality of products, Music&Lights S.r.l. reserves the right to modify the characteristics stated in this instruction manual at any time and without prior notice.  
All revisions and updates are available in the 'manuals' section on site [www.musiclights.it](http://www.musiclights.it)

**TABLE OF CONTENTS****Safety**

General instructions .....	2
Warnings and installation precautions .....	2
General information .....	3

**1 Introduction**

1.1 Description .....	4
-----------------------	---

**2 Installation**

2.1 Mechanical Requirements .....	6
2.2 Electrical Requirements .....	6
2.3 System Requirements .....	7

**3 System**

3.1 Brief Introduction .....	7
3.2 Key Benefits .....	8
3.3 Applications .....	8
3.4 System Components .....	8
3.5 Display Components .....	9
3.6 Frame .....	9
3.7 Module .....	11
3.8 Socket and Plug for Power and Data Connection .....	11
3.9 Receiver Card .....	12

**4 INSTALLATION**

4.1 Suspended Installation .....	13
4.2 Setup Process of Standing Installation .....	16
4.3 Data and power Cabling .....	19

**5 TROUBLESHOOTING**

5.1 Module Problems .....	20
5.2 Power Problems .....	20
5.3 Data Transfer Problems .....	20

**6 MAINTENANCE**

.....	21
-------	----

**Warranty**



**WARNING!** Before carrying out any operations with the unit, carefully read this instruction manual and keep it with care for future reference. It contains important information about the installation, usage and maintenance of the unit.



## SAFETY

### General instruction

- The products referred to in this manual conform to the European Community Directives and are therefore marked with **CE**.
- The unit is supplied with hazardous network voltage (230V~). Leave servicing to skilled personnel only. Never make any modifications on the unit not described in this instruction manual, otherwise you will risk an electric shock.
- Connection must be made to a power supply system fitted with efficient earthing (Class I appliance according to standard EN 60598-1). It is, moreover, recommended to protect the supply lines of the units from indirect contact and/or shorting to earth by using appropriately sized residual current devices.
- The connection to the main network of electric distribution must be carried out by a qualified electrical installer. Check that the main frequency and voltage correspond to those for which the unit is designed as given on the electrical data label.
- This unit is not for home use, only professional applications.
- Never use the fixture under the following conditions:
  - in places subject to vibrations or bumps;
  - in places with a temperature of over 40 °C.
- Make certain that no inflammable liquids, water or metal objects enter the fixture.
- Do not dismantle or modify the fixture.
- All work must always be carried out by qualified technical personnel. Contact the nearest sales point for an inspection or contact the manufacturer directly.
- If the unit is to be put out of operation definitively, take it to a local recycling plant for a disposal which is not harmful to the environment. 

### Warnings and installation precautions

- If this device will be operated in any way different to the one described in this manual, it may suffer damage and the guarantee becomes void. Furthermore, any other operation may lead to dangers like short circuit, burns, electric shock, etc.
- Always disconnect power from the mains, when device is not used or before cleaning!
- Before starting any maintenance work or cleaning the unit and when device is not used, cut off power from the main supply.
- Don't connect the device to a dimmer pack.
- Never let the power-cord come into contact with other cables! Handle the power-cord and all connections with the mains with particular caution!
- Never remove warning or informative labels from the unit.
- Do not shake the device. Avoid brute force when installing or operating the device.
- Do not switch the device on and off in short intervals.
- Never use the device during thunderstorms, unplug the device immediately.
- Only operate the device after having familiarized with its functions.
- Make sure that the device is not exposed to extreme heat, moisture or dust.
- Keep any inflammable material at a safe distance from the fixture.
- Make sure that the power-cord is never crimped or damaged. Check the device and the power-cord from time to time. If the external cable is damaged, it has to be replaced by a qualified technician.
- If device is dropped or struck, disconnect mains power supply immediately. Contact a qualified technical personnel inspect for safety before operating.

- If the device has been exposed to drastic temperature fluctuation (e.g. after transportation), do not switch it on immediately. The arising condensation water might damage your device. Leave the device switched off until it has reached room temperature.
- If your device fails to work properly, discontinue use immediately.
- For replacement use fuses of same type and rating only.
- This device is not designed for permanent operation. Consistent operation breaks will ensure that the device will serve you for a long time without defects.
- When hanging the product, always use a safety cable. When carrying out any work, always comply scrupulously with all the regulations (particularly regarding safety) currently in force in the country in which the fixture's being used.
- Do not operate the product if you see damage on the housing, LEDs, or cables. In any of these cases, have the damaged parts replaced by a qualified technician.
- The user is responsible for correct positioning and operating of the APIX6T. Music & Lights will not accept liability for damages caused by the misuse or incorrect installation of this device..

## GENERAL INFORMATION

### Shipments and claims

The goods are sold "ex works" and always travel at the risk and danger of the distributor. Eventual damage will have to be claimed to the freight forwarder. Any claim for broken packs will have to be forwarded within 8 days from the reception of the goods.

### Warranty and returns

The guarantee covers the fixture in compce with existing regulations. You can find the full version of the "General Guarantee Conditions" on our web site [www.musiclights.it](http://www.musiclights.it).

Please remember to register the piece of equipment soon after you purchase it, logging on [www.musiclights.it](http://www.musiclights.it). The product can be also registered filling in and sending the form available on your guarantee certificate. For all purposes, the validity of the guarantee is endorsed solely on presentation of the guarantee certificate. Music & Lights will verify the validity of the claim through examination of the defect in relation to proper use and the actual validity of the guarantee. Music & Lights will eventually provide replacement or repair of the products declining, however, any obligation of compensation for direct or indirect damage resulting from faultiness.

## - 1 - INTRODUCTION

### 1.1 DESCRIPTION

AlphaPIX6T is a LED module for the creation of ledscreens with 6,6 mm pixel pitch, ideal for video screening, pictures and backgrounds for medium viewing distances from ledwall surface.

The architecture of AlphaPIX6T is conceived with 640x720 mm module size, featuring 10368 SMD Full-Color LEDs for an impressive light output (up to 5500 NIT, suitable for day-light environments).

The module design is completely made in aluminium and the IP65 protection rate on front side makes AlphaPIX6T suitable also for temporary outdoor application.

The main structure is designed in aluminum, making AlphaPIX6T extremely lightweight, only 30 kg/m<sup>2</sup>, allowing a wide flexibility in configuration, also in hanging applications, with no limits of weight.

### Applications

- In environments where the video-projection is not allowed by the high luminosity or short depth of the room
- In TV Studios for multiple viewing angle
- Touring and Live event for Camera streaming
- Large trade-show booths with creative video imaging
- In theme parks or public events

### Mechanical architecture

- Module dimensions (WxHxD): 640x720x100 mm
- Module weight: 13,5 kg
- Weight per square meter: 30 kg
- Internal protection: IP65/IP43
- Die-cast aluminium housing
- Mechanical finishing: black
- Seamless locking system
- Cooling: natural airflow
- Vertical hanging system: built-in aliscaf clamp support

### Electrical features

- Power supply: AC 110/230V 50/60Hz
- Power IN connections: Neutrik Powercon
- Max power consumption (module): 415W
- Average power consumption (module): 139W
- Max rated current/cabinet: AC 220V/1.88A
- Max power consumption (per square meter): 900W
- Average power consumption (per square meter): 300W
- Power output: Max 3 modules
- MTBF: > 1.000 h
- Working temperature/humidity: -20°C - +60°C / 10% - 90%

### Video features

- LED source: high-power SMD2727 FullColor black face
- Module resolution: 96x108 pixel, 10'368 total pixel
- Pixel pitch: 6,6 mm
- LED density: 22'500 LED/sqm
- Luminous flux: 5'500 cd/sqm (NIT)
- Best viewing distance: 8 - 100 m

- LED life span: >100'000h
- Colours: >4,4 triloni through RGB mixing
- Grayscale: 16 bit (16'384 level)
- Refresh rate:  $\geq 1'920$  Hz
- Colour calibration through PC software
- Input video signals: AV, S-Video, VGA, DVI, HDMI, SDI, DP
- Viewing angle: 140° horizontal, 70° vertical
- Dead pixel ratio: <0,002

**Control system**

- Dedicated G2 NOVASTAR interface (Sender box) for video signal distribution and screen configuration (not included)
- Data IN sender box: USB connector
- Data IN module: RJ45 connectors
- Connection between screen and sender box: USB cable
- Connection between sender box and videowall: CAT5 data cable



Technical specification	
LED Type	High-power SMD2727 FullColor black face
Pixel Pitch	6.6 mm
Pixel Density	22'500 pixels/m <sup>2</sup>
Viewing Angle (H/V)	140°H/70°V
Brightness	5'500 nit
Color Depth	8192 bytes
Drive Mode	1/6 scan, constant current
Grey Level	16 bit
Refresh frequency	≥1920 Hz
Brightness Adjustment	Manual/Auto/Programmable
Panel Dimension (WxH)	640x720x100 mm
Panel Resolution (WxH)	96x108 pixels
Module Resolution	48x36 pixels
Panel Weight	13.5 kg
Panel Type and Material	Die-casting aluminum
Protection Grade	IP65/IP43
Power Supply	AC 110/230V 50/60Hz
Connectors	Powercon Ethercon
Control Protocol	Novastar
Hanging Panel Quantity	≤15 panels
Avg. Power Consumption	300 W/sqm
Max. Power Consumption	900 W/sqm
Operating Temp/Humidity	-20°C +50°C / 10%-90%
Compt Standard	CE

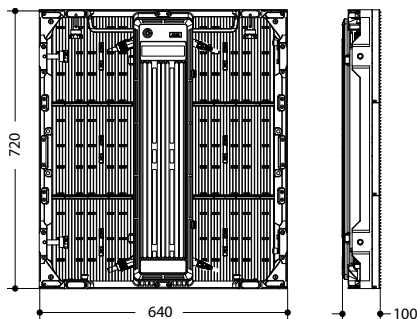



## 2. INSTALLATION REQUIREMENTS

This chapter specifies the requirements for safety, mechanism, electricity and control software of APIX6T LED display.

**Warning:** This LED indoor product is designed for outdoor. Both outdoor and indoor can be used.

### 2.1 Mechanical Requirements

**Weight Warning:** Do not underestimate the weight of a complete APIX6T LED display. Be sure that The floor or truss installation on which the APIX6T display has to be installed is capable of Handling five (5) times the complete load of the display. For floor mounting, conclude the weight of any other load.

**Caution:** One APIX6T tile weighs approximately 13.5 kg.

#### Horizontal surface

For floor installation, the floor on which APIX6T display is installed must be horizontal. Never install LED display on a slant surface.

#### Ballast

Depending on the height of the display and the position of the LED display upon the foot beams (somewhere between front and middle) additional weight (ballast) will be required.

#### Truss beam

The truss beam has to be provided and installed by the customer. Pay attention to following points for installation design and preparation. Calculate precisely for on individual basis.

#### Weight tolerances:

Ensure that the truss beam and the ceiling against which the truss beam has to be installed is able to handle the complete weight of the APIX6T LED display.

#### Ceiling stability.

#### Installation ambience

Environmental conditions: humidity, ventilation, temperature, etc.

Location: Altitude, etc.

Front clearances: for optimal effect, ensure that enough free space is supplied in front of the LED display and respect the minimum viewing distance.

#### Comply with local regulations regarding such installations.

**Warning:** Suspending installation is limited to 15 tiles in vertical direction.

### 2.2 Electrical Requirements

#### Power requirements

The displaying area of one APIX6T tile is 0.460 m<sup>2</sup>. APIX6T LED tiles have pixel densities (see Appendix A – technical specifications). For different pixel densities, one APIX6T tile may need power supply of 0.6 amps to 1.5 amps at 220 VAC, 100-250 VAC, 50-60 Hz. Each APIX6T tile has one input and one output socket of AC power. The power is distributed to display tiles by power split cables from power distributor. However, one power split cable can be connected with 8 – 20 tiles in parallel. So, one power split cable has to be provided for every 8 – 20 tiles. Protect every power cable by a circuit breaker or fuses rated 16 A / 250 VAC (15 A / 110 VAC in the USA and Canada). PROLIGHTS provides a range of power distributor to satisfy the demands of your LED display. See more details for power distributor of LED display in Power Distribution Section. Contact PROLIGHTS for more information.

## Power system

It is recommended to use power distribution system with a separate neutral and grounding conductor to avoid large current loops due to voltage differences in the neutral conductor.

- Protect the electrical installation by switch, circuit breaker, over-voltage protector, defective grounding circuit breaker with proper rated power.
- Install the display in accordance with local electrical installation standards. In Europe, comply with EN 60364, the standard for electrical installation of buildings. In Germany, comply with EN 60364. In America, comply with National Electrical Code ANSI/NFPA 70.

## Protective grounding

To prevent against the risk of electric shock, the installation should be properly grounded. Defeating the purpose of grounding will expose you to the risk of electric shock.

## 2.3 System Requirements

Before you begin, it is assumed that you are familiar with the Windows operating software. Windows 7 Ultimate is allowed to launch the relative control software.

### System requirements

Minimum specifications:

- Hardware

- PC PentiumIV 2.0 GHz or equivalent
- 1 GB RAM
- Free hard disk space: 10GB
- XGA resolution (1024 x 768)
- Serial communicationport
- Ethernet connection

- Software

- Windows7 Professional/ Ultimate

Recommended specifications:

- Hardware

- PC Intel i5 processor or above
- 4GB RAM
- Free hard disk space: APIX6T GB
- SXGA resolution (1280 x 1024), with 512MB video memory
- Serial communication port
- Ethernet connection

- Software

- Windows 7 Professional

## 3. SYSTEM INTRODUCTION

### 3.1 Brief Introduction

APIX6T is the LED indoor display product of PROLIGHTS that uses die-casting aluminum frame with CNC high precision machining techniques. With its compact, light and handy exterior, the LED tile is easy to install and disassemble. As the tile dimension is of very high precision, so the whole display keeps in high flatness and seamless.

### 3.2 Key Benefits

- High resolution and high pixel density, reproducing reality of high definition video
- Uniform color and high contrast, ensuring clear and sharp picture
- High precision die-casting aluminum tile, achieving high flatness and seamless matching of the whole display
- Fan design with good heat dissipation, achieving noise-free
- Light and slim tile, easier to handle and transport
- High stability and reliability, prolonging lifespan of the display

### 3.3 Applications

Indoor hall, multi-functional conference hall, performing hall, theater, stage, command and control center and so on.

### 3.4 System Components

APIX6T LED display system includes the following basic components:

- LED Display: APIX6T LED display tiles, power supply cables, signal cables, connectors
- Control System: control computer, LED display controller, DVI splitter, control system software
- Power Distribution System: power distribution box, power cables
- Peripheral Devices: video processor, optical fiber transmitter

#### LED Display Components List

Number	Name	Function /Explanation
LED Display Components		
1	APIX6T display tile	Tile size: 640mmX 720mm,Weight: 13.5 kg
2	Power cord plug and socket	Used for power cable loop connection between tiles; plug for input and socket for output
3	RJ45 data cord plug and socket	Used for data link between tiles; both sockets can be used for output or input
Control System Components		
1	LED display control computer	Industrial control computer
2	Controller (sending card)	Configure and send video signal
3	Graphic card	Support the output of multiple screens
4	Light sensor	Receive signal data (One card for one tile)
5	Receiver card	Configure and send video signal
6	Multi-Function card	Support power supply remote control, support feeding back humidity and temperature information.
7	LED control system software	<ol style="list-style-type: none"> <li>1. Control, configure and publish play list on LED display</li> <li>2. Support calibration on-site</li> <li>3. Support manual and automatic brightness adjustment</li> <li>4. Support turning on/off LED display through remote network</li> </ol>

Number	Name	Function /Explanation
Power Distribution System Components		
1	Main power distributor	Supply power for LED screen (Support power supply remote control)
2	Power distribution box	Support power supply remote control
3	Lightning arrester	International brand, to avoid lightning
4	Power cable	Comply with international standards
Peripheral Devices		
1	Video processor	Support for peripheral video source
2	Optical fiber transmitter	Both single mode and multiple modes optical fiber transmitter can be used; multiple modes transmitter for R M, and single mode transmitter for 20KM
3	Optical fiber	8 cores optical fiber with premium brand
4	Heat sink devices	Axial flow fan can be chosen according to the heat dissipation space and the environment temperature

### 3.5 LED Display Components

#### APIX6T Tile

APIX6T LED display is built with APIX6T tiles. A tile consists of die-casting aluminum frames in high accuracy, APIX6T display modules, switching power supply, receiver cards, and some other mechanical and electrical connection parts. The APIX6T die-casting aluminum frame adopts one time die-casting and CNC precision processing technology with high quality aluminum to ensure the high accuracy of the frame and the uniformity of the whole display.

The introduction of the main components of APIX6T tile is shown as below with related images.

#### 3.6 Die-Casting Aluminum Frame

Each die-casting aluminum frame is installed with four APIX6T display modules. There are LED signal receiver cards and low voltage DC switching power supply inside the frame, and they all have electrical connection with 6 modules. There are special designs for fixing and connecting the tiles at each side of the die-casting aluminum frame. The frame has attachment points at the back and four corners. The attachment points are to fix the tiles to the supports like steel structures and buildings.

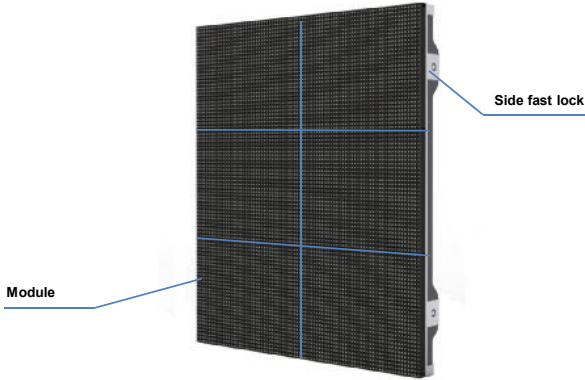

1. APIX6T tile has 6 grids for 6 modules to be fixed in. Each grid has 8 screws to fix one module. The precise positioning ensures the precise position of all modules. Keep screws clean to achieve smooth installation of the modules and avoid seams between tiles and uneven pixel pitches.

2. Each of the four corners at the back of APIX6T die-casting aluminum frame has a fixed screw hole to support the installation. Each side of the upper frame has fast locks used for the precise connection between the upper and lower tiles.

**Warning:**

A maximum of 15 tiles are limited to stack up or suspend without the external support.

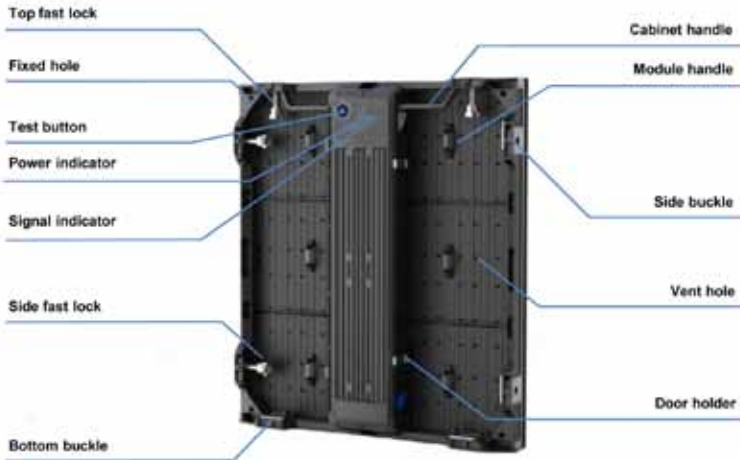

### 3.7 APIX6T Module

APIX6T module includes plastic cover, PCBA, plastic mask, etc. At the back of the plastic base frame, Both front and back service design. Over the lamps, replaceable masks are equipped to protect the LED lamps and PCB and increase the use life of display. PROLIGHTS choose the best full color SMD LED lamps as materials. Which lead to high uniformity and perfect show effect. The use of black organic silicone makes the black LED lamps darker to improve the contrast of the display significantly.

APIX6T tile includes 2×3 modules. Each module has 2 kinds of pixel pitch (mm): PH 6.67mm & PH 8 mm with the corresponding module resolution (pixel) of 96×108 & 80×90. The weight of each display module is about 0.95kg.

#### Warning:

APIX6T die-casting aluminum frame can only install APIX6T display modules.

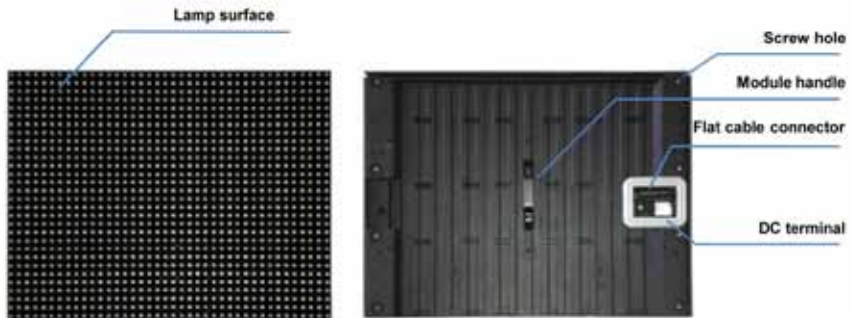

### 3.8 Socket and Plug for Power and Data Connection

The following two types of socket and plug are respectively used for the power and data connection between APIX6T display tiles. Both data and power socket is for the data or power connection between upper and lower tiles.



### 3.9 LED Receiver Card

Each APIX6T tile has one receiver card for receiving and transmitting the data of LED display .  
The functions of the MRV220 receiver card are shown as below:

- Power supply: 3.3 - 5.0V
- Temperature monitoring(standard feature)
- Power supply voltage monitoring(standard feature)
- Working status monitoring(standard feature)
- 16 RGB data groups output (it can be extended to 32 groups.)
- Load capacity of single receiver card up to 256×208
- Support pixel level brightness/color calibration

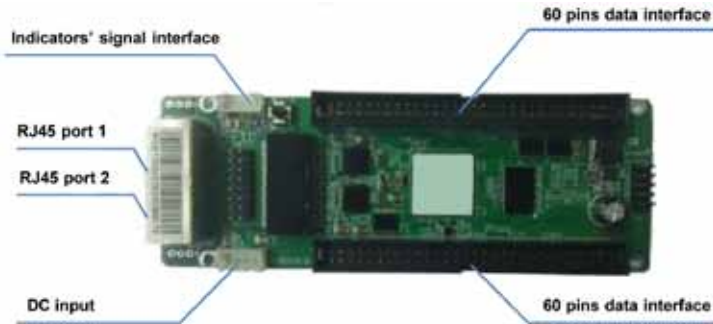

## 4. APIX6T INSTALLATION

### 4.1 Suspended Installation

Warning: APIX6T display is limited to a height of 20 display tiles and the display surface has to obtain the flatness within a tolerance zone of +/-0.2 mm and keep perpendicular to the reference surface.

#### Setup Process

1. Assemble five APIX6T tiles ,connect all truss bars, keep them on the same level .assemble the first line of cabinets. Screw down side lock by hand one by one. All jobs is easy operated.

**Warning:** APIX6T side fast locks were chosen the same devices with bottom fast locks, when combine horizontally ,please kindly follow the same method to assemble as above.

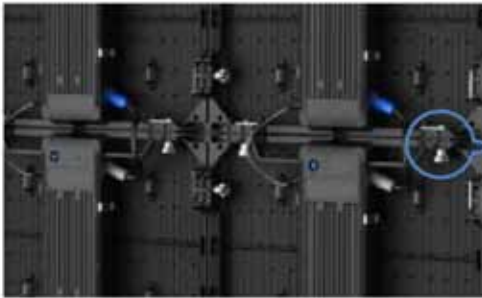
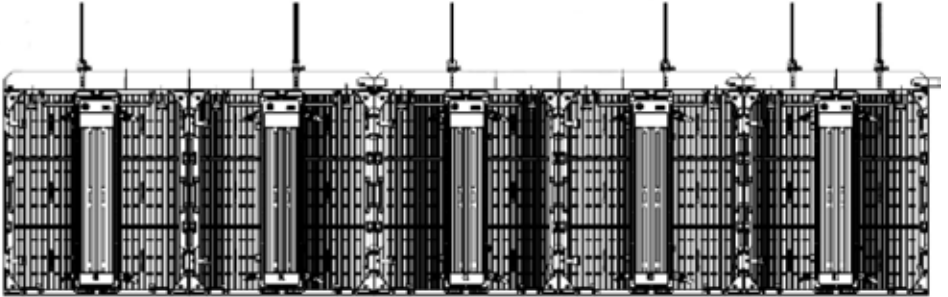

Buckle

Push fast lock upside

Push buckle

Screw down

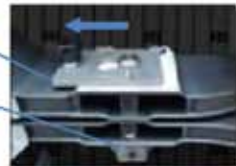



2. Assemble APIX6T tiles line by line , install from middle to side, and from top to bottom keep all truss bars on the same level.

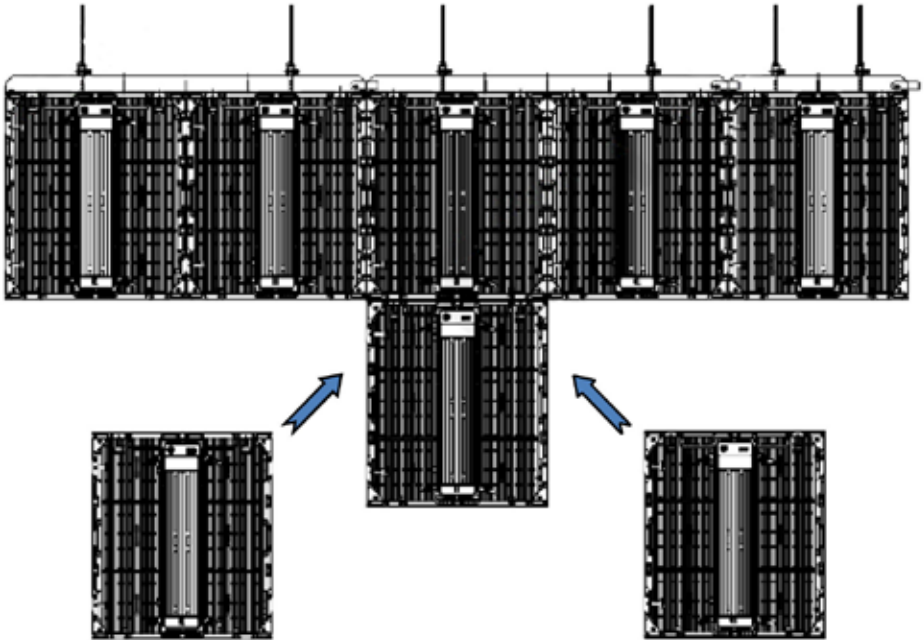

3. Install all the tiles for a whole screen.

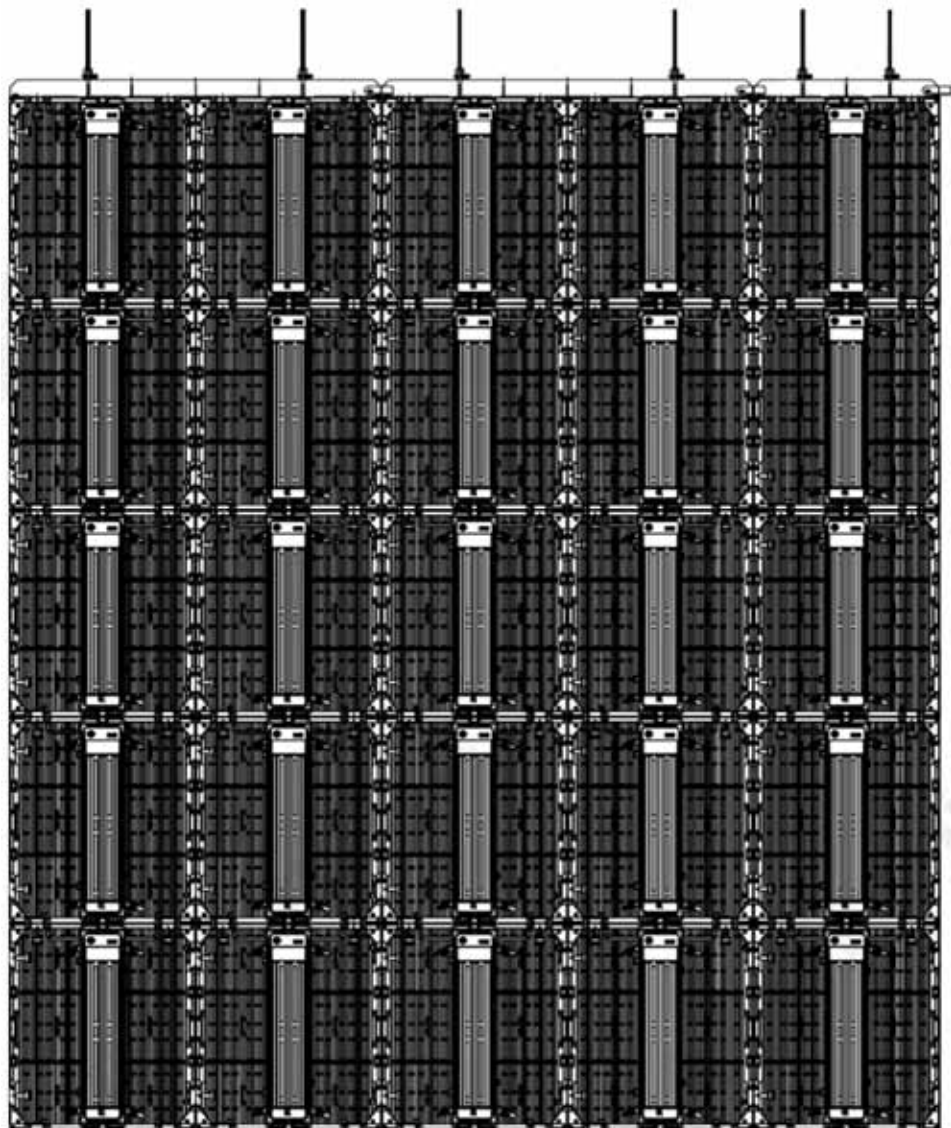

## 4.2 Setup Process of Standing Installation

**Warning:** The height of APIX6T tiles depends on the height of supporting steel structure and the display surface has to obtain the flatness within a tolerance zone of  $\pm 0.2\text{mm}$  and keep perpendicular to the reference surface.

### Setup Process

1. Assemble five APIX6T tiles ,make sure all steel structure were under right design, keep base flat on the same level .assemble the first line of cabinets. Screw down side lock by hand one by one. All jobs is easy operated.

**Warning:** APIX6T side fast locks were chosen the same devices with bottom fast locks, when combine horizontally ,please kindly follow the same method to assemble as above.

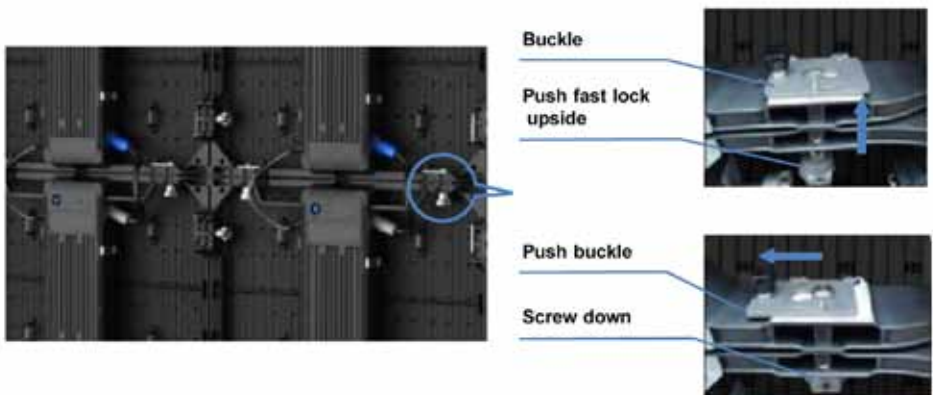
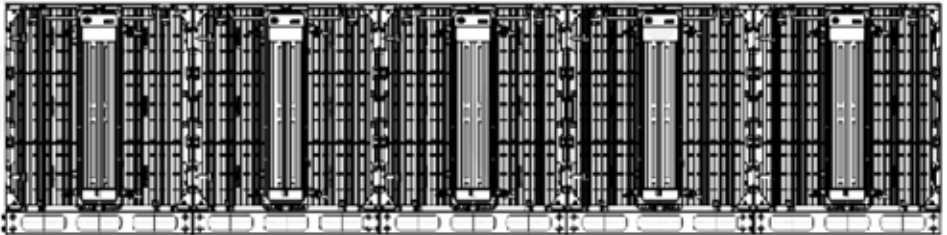

2. Assemble APIX6T tiles line by line , install from middle to side, and from bottom to top .keep each line of tiles on the same level.

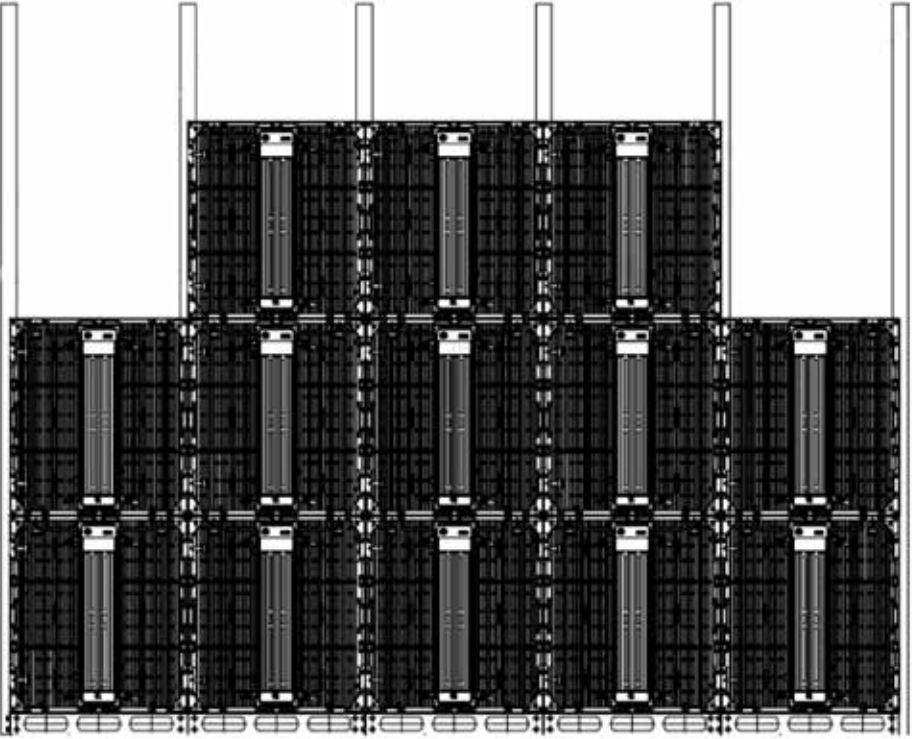

3. Fix the corners of four adjacent tiles with connecting plates and corresponding screws, make sure fixed fasten to steel structure. and make appropriate adjustments if necessary to ensure the smooth and seamless surface of the APIX6T display.

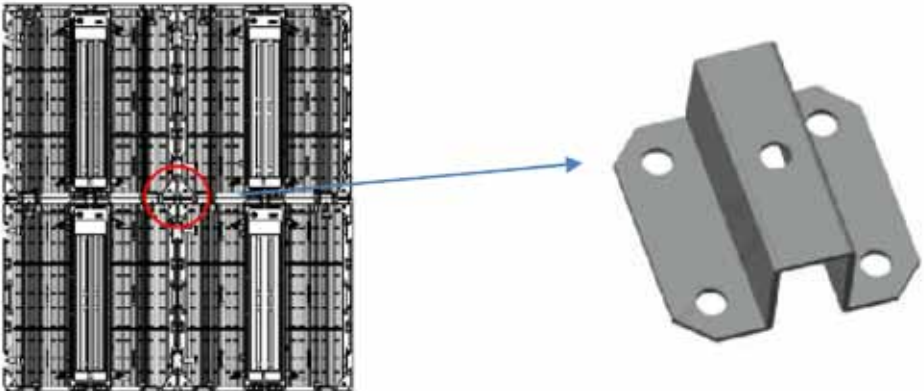

4. Fix all the corners of the APIX6T tiles at the bottom and flanks with connecting plates. Fix the connecting plates to the supporting steel structure at the back of the display. (See the steel structure design and installation image for more details.)

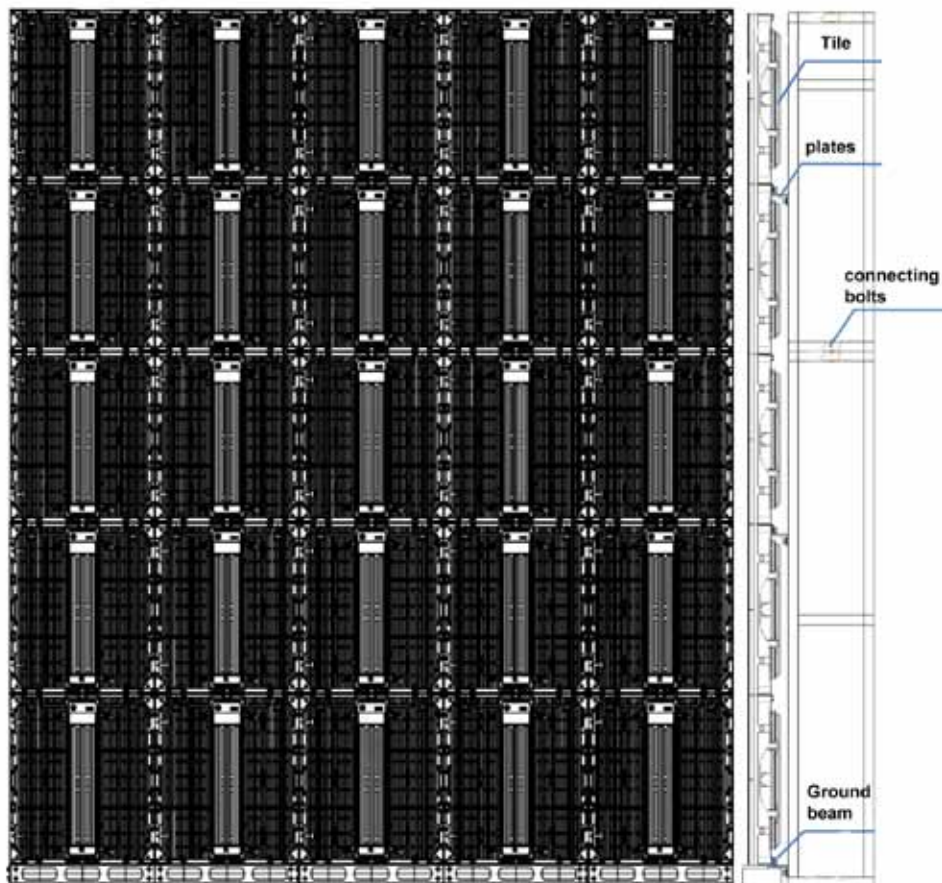

### 4.3 Data and power Cabling

Connect power cable and signal cable as below :for it's design, power cable should be connected line by line, factory original main power cable is 2.5 mm<sup>2</sup>, for safe use ,each cable limited to connected 10 tiles. Signal cable connect from the first tile still to the last one, link all tiles as "Z" or "N".

#### Warning:

Please pay attention to the connection from image 4-11,which will be as the reference of the latter software screen connection configuration

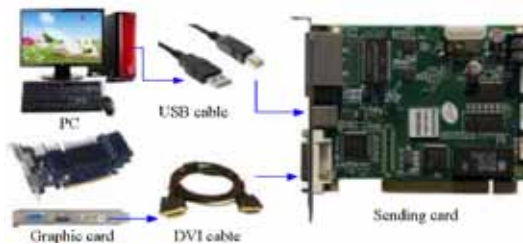
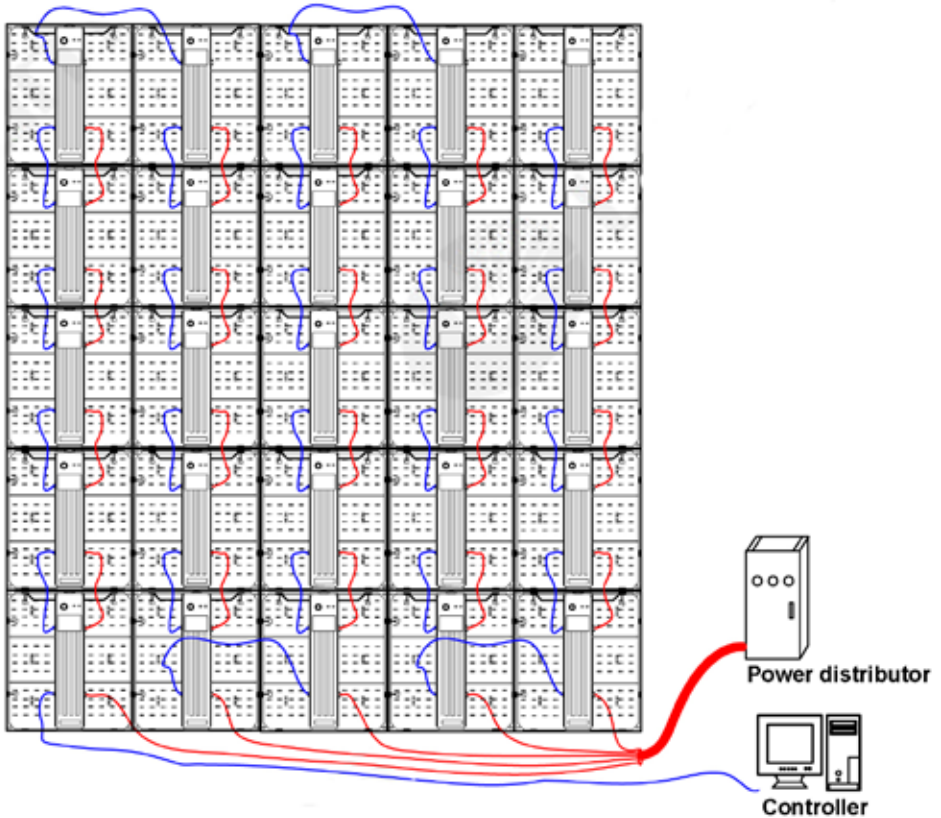

## 5. TROUBLESHOOTING

### 5.1 Module Problems

Problem type	Problem description	Solution	Reason	Analysis
LED lamp	Blind lamps	Replace the lamp or module	The lamp is dead or soldering is not good	
LED pixel	The pixel area is black or loses color	Replace the lamp or module	The driving IC/resistor is bad soldered or out of work	
LED module	One or several whole LED modules in the same row are black or defective	Check the flat cable and power cable connection on the module	Cable is not connected or not well connected	

### 5.2 Power Problems

Problem type	Problem description	Solution	Reason	Analysis
Tile power	The whole tile is black	Check power connection with the tile and the breaker in the tile	Power to the tile is not well or the breaker is turned off	
Power supply	The whole tile is black	Replace the defective power supply	The power supply feeding the receiver card is defective	
Power supply	Several nearby module areas are black	Replace the defective power supply	The power supply feeding the module area is defective	

### 5.3 Data Transfer Problems

Problem type	Problem description	Solution	Reason	Analysis
Fiber	The display is black	Check the fiber connection and the data I/O order	The fiber cable is broken or the data I/O order is wrong	
Cat 5	The whole column of the display is black	Check the data connection between the divider and the first scan card	The connection is not good or the cat5 is defective	
Cat 5	One or several tiles in column are black	Check the cat5 connection between the tiles	The connection is not good or the cat5 is defective	
Cat 5	All the display light up but the columns are not in right order	Check and correct the Cat5 connection order in the divider	The connection order is wrong	

## 6. MAINTENANCE

### **Routine maintenance**

1. Make sure the LED display is well ventilated, dry and running in suitable temperature.
2. Regularly check the internal cables inside the LED display are in stable connection, the power supplies are working well, the ground wires are connected well, and the lightning arrester is running well.
3. Regularly wipe the dust on the surface of the LED tile with a soft cloth, and keep the LED display surface clean to avoid brightness differences between clean and unclean LED tiles.

### **Cautions for use**

1. Before power on the LED display, start your computer first, and then turn on the power of LED display.
2. Before turn off the display system, first turn off the power of LED display, and then turn off the computer.
3. When you are editing video playlist, you had better to keep the LED display closed.
4. When failure appears, first turn off the power of LED display, then contact with service department of PROLIGHTS for technical support.





**Il prodotto è coperto da garanzia in base alle vigenti normative. Sul sito [www.musiclights.it](http://www.musiclights.it) è possibile consultare il testo integrale delle "Condizioni Generali di Garanzia".**

#### Estratto dalle

#### Condizioni Generali di Garanzia

- Si prega, dopo l'acquisto, di procedere alla registrazione del prodotto sul sito [www.musiclights.it](http://www.musiclights.it). In alternativa il prodotto può essere registrato compilando e inviando il modulo riportato sul retro.
- Sono esclusi i guasti causati da imperizia e da uso non appropriato dell'apparecchio.
- La garanzia non ha più alcun effetto qualora l'apparecchio sia stato manomesso.
- La garanzia non prevede la sostituzione dell'apparecchio.
- Sono escluse dalla garanzia le parti esterne, le lampade, le manopole, gli interruttori e le parti asportabili.
- Le spese di trasporto e i rischi conseguenti sono a carico del possessore dell'apparecchio.
- A tutti gli effetti la validità della garanzia è avallata unicamente dalla presentazione del certificato di garanzia.

The guarantee covers the unit in compce with existing regulations. You can find the full version of the "General Guarantee Conditions" on our web site [www.musiclights.it](http://www.musiclights.it).

#### Abstract

#### General Guarantee Conditions

- Please remember to register the piece of equipment soon after you purchase it, logging on [www.musiclights.it](http://www.musiclights.it). The product can be also registered filling in and sending the form available on your guarantee certificate.
- Defects caused by inexperience and incorrect handling of the equipment are excluded.
- The guarantee will no longer be effective if the equipment has been tampered.
- The guarantee makes no provision for the replacement of the equipment.
- External parts, lamps, handles, switches and removable parts are not included in the guarantee.
- Transport costs and subsequent risks are responsibility of the owner of the equipment.
- For all purposes, the validity of the guarantee is endorsed solely on presentation of the guarantee certificate.

# Music & LIGHTS®

## CERTIFICATO DI GARANZIA GUARANTEE CERTIFICATE

Spett.le  
**Music&Lights S.r.l.**  
Via Appia Km 136.200  
04020 Itri (LT) Italy

Place Stamp Here  
Affrancare

MODEL / MODELLO

SERIAL N° / SERIE N°

Purchased by / Acquistato da

SURNAME / COGNOME

NAME / NOME

ADDRESS / VIA

N.

CITY / CITTA'

ZIP CODE / C.A.P.

PROV.

Dealer's stamp  
and signature

Timbro e firma  
del Rivenditore

Purchasing date

Data acquisto

FORM TO BE FILLED IN AND MAILED / CEDOLA DA COMPILARE E SPEDIRE

MODEL / MODELLO

SERIAL N° / SERIE N°

Purchased by / Acquistato da

SURNAME / COGNOME

NAME / NOME

ADDRESS / VIA

N.

CITY / CITTA'

ZIP CODE / C.A.P.

PROV.

Dealer's stamp  
and signature

Timbro e firma  
del Rivenditore

Purchasing date

Data acquisto

FORM TO BE FILLED IN AND KEPT / CEDOLA DA COMPILARE E CONSERVARE

**MUSIC & LIGHTS S.r.l.**

---

Via Appia, km 136,200 - 04020 Itri (LT) - ITALY  
Phone +39 0771 72190 - Fax +39 0771 721955

[www.musiclights.it](http://www.musiclights.it) - email: [info@musiclights.it](mailto:info@musiclights.it)

ISO 9001:2008 Certified Company

**PROLIGHTS** è un brand di proprietà della Music & Lights S.r.l.      **PROLIGHTS** is a brand of Music & Lights S.r.l. .company.      ©2016 Music & Lights S.r.l.

A decorative graphic consisting of a vertical column of 28 horizontal bars of varying lengths, creating a stylized, rhythmic pattern.