

Photometric Test Report



AstraWash7PixIP

IP65 moving wash light with 7x40W LED

and 4° - 56° zoom

CONTENTS

Table of contents	2
Testing process	4
Color preset Full on	
Beam angle Max Zoom	5
Beam angle Med Zoom	8
Beam angle Min Zoom	11
Color preset Red	
Beam angle Max Zoom	14
Beam angle Med Zoom	17
Beam angle Min Zoom	20
Color preset Green	
Beam angle Max Zoom	23
Beam angle Med Zoom	26
Beam angle Min Zoom	29
Color preset Blue	
Beam angle Max Zoom	32
Beam angle Med Zoom	35
Beam angle Min Zoom	38
Color preset White	
Beam angle Max Zoom	41
Beam angle Med Zoom	44
Beam angle Min Zoom	47
Color preset 2800K	
Beam angle Max Zoom	50
Beam angle Med Zoom	55
Beam angle Min Zoom	60
Color preset 3200K	
Beam angle Max Zoom	65
Beam angle Med Zoom	70
Beam angle Min zoom	75

Color temperature 4000K

Beam angle Max Zoom 80

Beam angle Med Zoom 85

Beam angle Min Zoom 90

Color temperature 5600K

Beam angle Max Zoom 95

Beam angle Med Zoom 100

Beam angle Min Zoom 105

Color temperature 6000K

Beam angle Max Zoom 110

Beam angle Med Zoom 115

Beam angle Min Zoom 120

TESTING PROCESS

Prolights has its own optical testing laboratory in order to provide accurate photometric reports for its lighting products. The testing laboratory contains certain variety of precise lighting measurement systems that ensure an optimal reading of all the characteristic parameters of the lighting devices. All measurements are made at a controlled room temperature of 25°C without any external light sources. This photometric report is obtained through the data measured by a high precision measurement system and analyzed by a dedicate software.

Prolights measurement instrument

Prolights measurement instrument is a complete measurement system for any light source. It's equipped with two-axis goniometer, that enables to measure the full 3D distribution field of the light source. This instrument measures the light intensity, the beam angle and the most significative colors parameters, like color temperature, spectral distribution, CRI, CQS, TM-30 with a very high accuracy rate.

Please Note: All measurements are made with light source at operating temperature. Before starting the measurement, the instrument analyzes the process of the light source during the heating phase. The measuring process of all the parameters begins only when the light emission is stable, that is with a variation of less than 0.5% in a 15 minutes time frame.

Prolights measurement software

The software provides user friendly interface for the operator who does the measurements, and it also analyzes and processes all the collected data by the instrument. With this software it is possible to see the measured data in real-time and it is possible to examine all the measured data and graphics afterwards as well. All information is collected in a specific Prolights template, and the software creates also IES and LDT files, which are widely used to transfer the photometric data, and to develop lighting system.

Additionally, the fixtures are rechecked using various hand-held instruments like Sekonic C-700 and Gossen Mavospec Base, this is done to ensure, that the data in the photometric report are as accurate as possible.



Total lumen output:

3543 lm

Peak candela output:

9096 cd

PRODUCT NAME:

ASTRAWASH7PIXIP

MEASUREMENT CONDITIONS:

Beam angle:

Max Zoom

Target:

Full On Cal. Off

Operator:

Paolo Carvone

Date and time:

15/02/2021 16:41:11

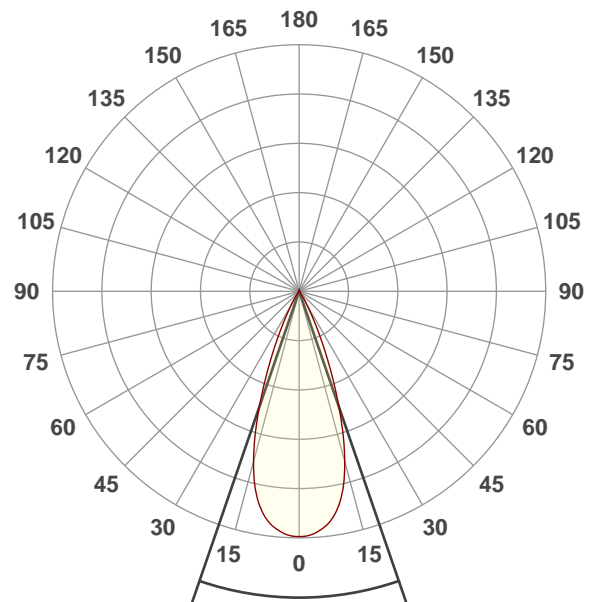

Beam angle 50%: 38°

Field angle 10%: 56,2°

Cut off angle 2.5%: 67,6°

Spectra

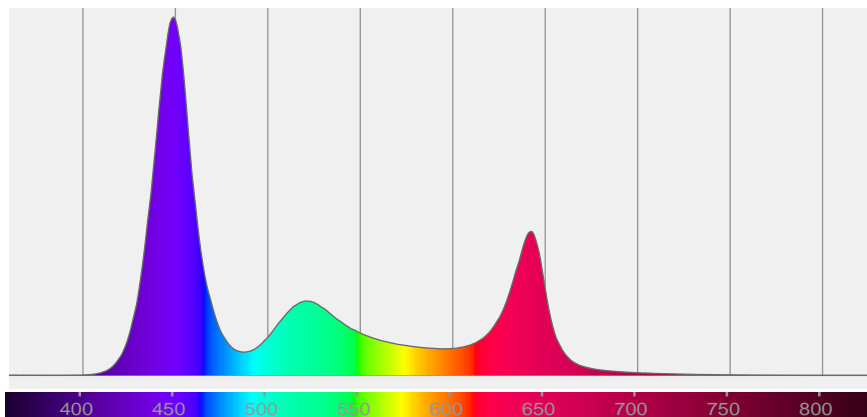

BEAM DETAILS



Beam angle 50%	Field angle 10%	Cut off angle 2,5%	Intensity ratio in 120° cone	Intensity ratio in 90° cone
38°	56,2°	67,6°	99,9%	99,9%

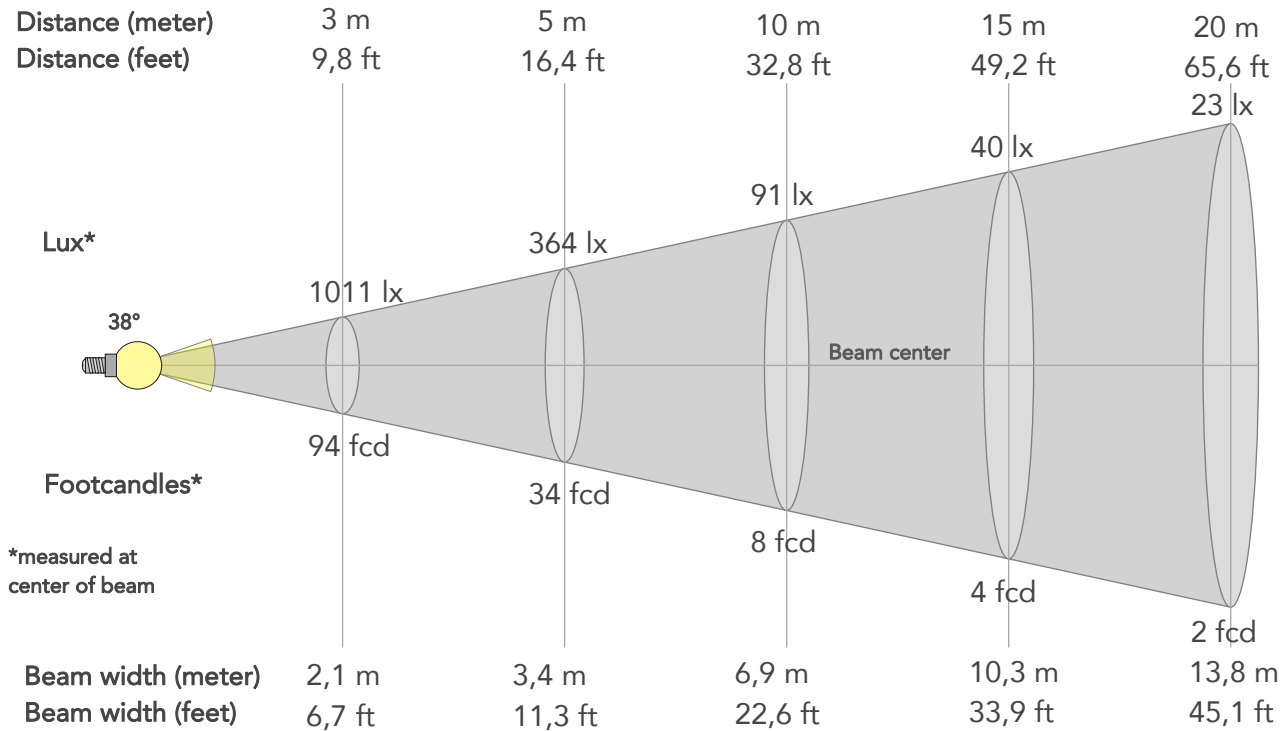

BEAM INTENSITIES AND WIDTHS

Distance	1m	2m	3m	4m	5m	7,5m	10m	15m	20m	25m	30m	40m	50m
Distance	3,3ft	6,6ft	9,8ft	13,1ft	16,4ft	24,6ft	32,8ft	49,2ft	65,6ft	82ft	98,4ft	131,2ft	164ft
Lux	9096lx	2274lx	1011lx	569lx	364lx	162lx	91lx	40lx	23lx	15lx	10lx	6lx	4lx
Footcand.	845fcd	211fcd	94fcd	53fcd	34fcd	15fcd	8fcd	4fcd	2fcd	1fcd	1fcd	1fcd	0fcd
Beam wid.	0,7m	1,4m	2,1m	2,8m	3,4m	5,2m	6,9m	10,3m	13,8m	17,2m	20,6m	27,5m	34,4m
Beam wid.	2,3ft	4,5ft	6,7ft	9ft	11,3ft	16,9ft	22,6ft	33,9ft	45,1ft	56,4ft	67,7ft	90,3ft	112,9ft

LINEAR DISTRIBUTION DIAGRAM

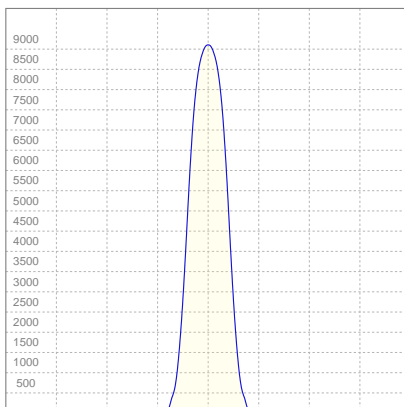

ELECTRICAL SPECIFICATIONS

Input voltage	Input current	Input power	Effeciency
222V	1,07A	220,5W	16lm/W

Power FC
0,93

ISO CANDELA DIAGRAM

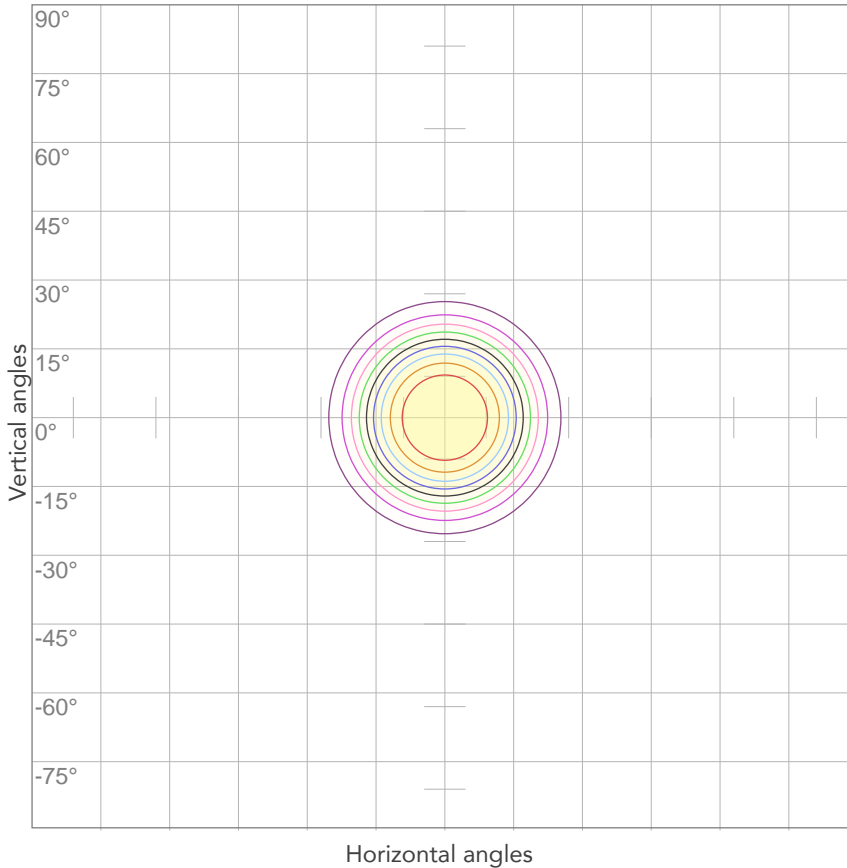

10%	910 cd
20%	1819 cd
30%	2729 cd
40%	3639 cd
50%	4548 cd
60%	5458 cd
70%	6367 cd
80%	7277 cd

Conditions:

Number of c-planes: 2

Candela at center: 9096 cd

ISO LUX DIAGRAM

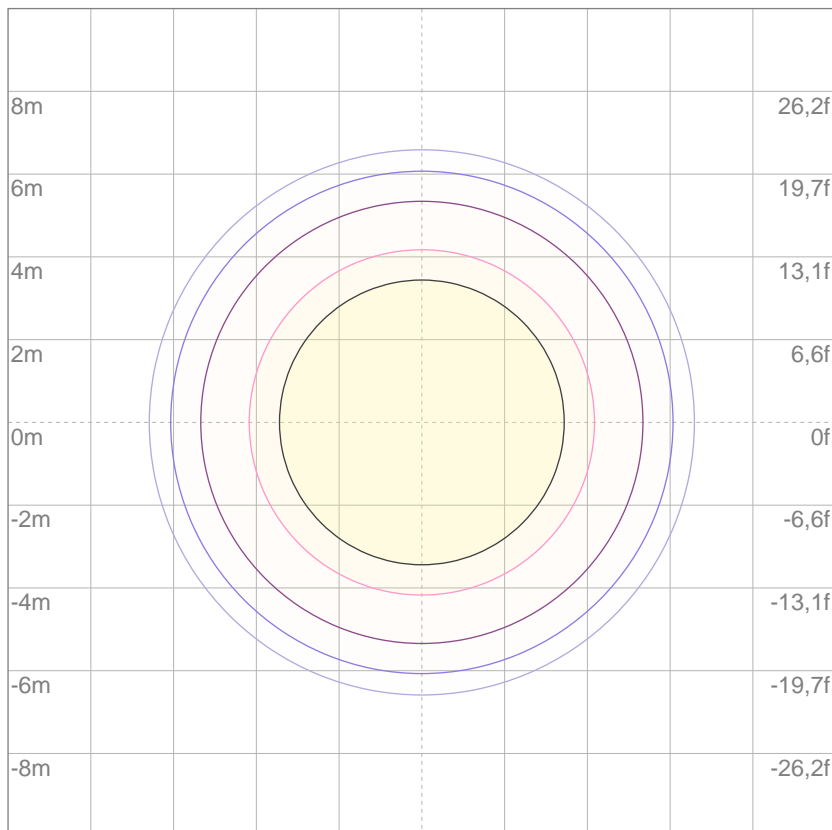

3%	2,73 lx
5%	4,55 lx
10%	9,10 lx
30%	27,3 lx
50%	45,5 lx

Conditions:

Number of c-planes: 2

Lux at center: 91,0 lx

Lux distribution on a surface when lamp is mounted at 10 meters from the surface.

Mounting height: 10 meters (33 feet)



Total lumen output:

3061 lm

Peak candela output:

36548 cd

PRODUCT NAME:

ASTRAWASH7PIXIP

MEASUREMENT CONDITIONS:

Beam angle:

Med Zoom

Target:

Full On Cal. Off

Operator:

Paolo Carvone

Date and time:

15/02/2021 16:43:29

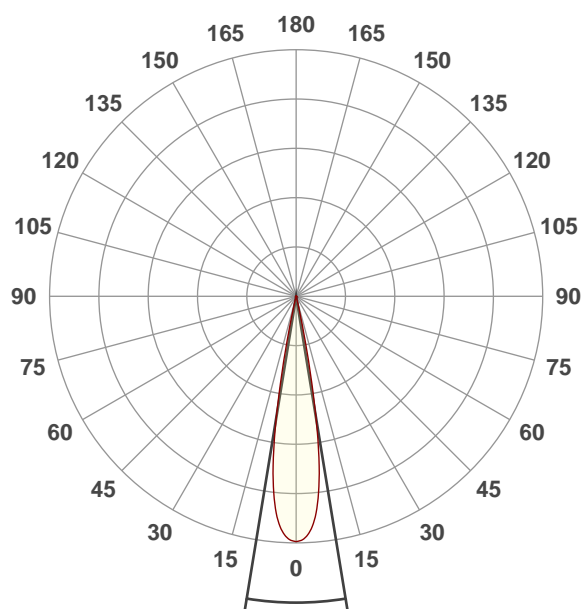

Beam angle 50%: 18,6°

Field angle 10%: 24,6°

Cut off angle 2.5%: 27,2°

Spectra

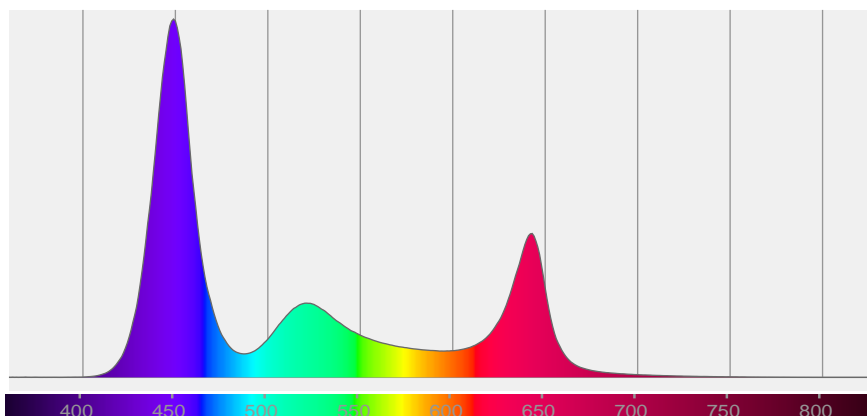

BEAM DETAILS



Beam angle 50%	Field angle 10%	Cut off angle 2,5%	Intensity ratio in 120° cone	Intensity ratio in 90° cone
18,6°	24,6°	27,2°	99,9%	99,9%

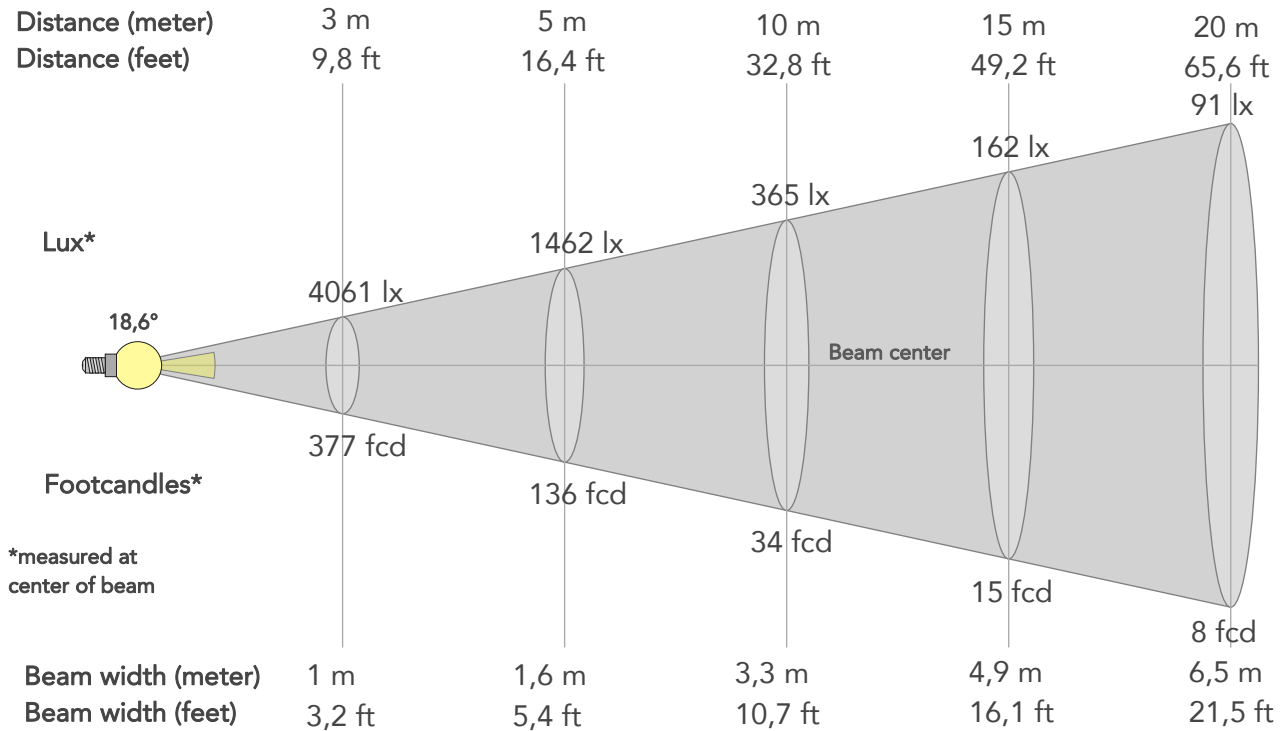

BEAM INTENSITIES AND WIDTHS

Distance	1m	2m	3m	4m	5m	7,5m	10m	15m	20m	25m	30m	40m	50m
Distance	3,3ft	6,6ft	9,8ft	13,1ft	16,4ft	24,6ft	32,8ft	49,2ft	65,6ft	82ft	98,4ft	131,2ft	164ft
Lux	36548lx	9137lx	4061lx	2284lx	1462lx	650lx	365lx	162lx	91lx	58lx	41lx	23lx	15lx
Footcand.	3395fcd	849fcd	377fcd	212fcd	136fcd	60fcd	34fcd	15fcd	8fcd	5fcd	4fcd	2fcd	1fcd
Beam wid.	0,3m	0,7m	1m	1,3m	1,6m	2,5m	3,3m	4,9m	6,5m	8,2m	9,8m	13,1m	16,4m
Beam wid.	1,1ft	2,2ft	3,2ft	4,3ft	5,4ft	8ft	10,7ft	16,1ft	21,5ft	26,8ft	32,2ft	42,9ft	53,7ft

LINEAR DISTRIBUTION DIAGRAM

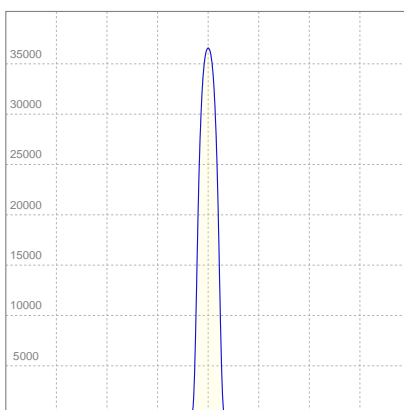

ELECTRICAL SPECIFICATIONS

Input voltage	Input current	Input power	Effeciency
223V	1,06A	220,7W	14lm/W

Power FC
0,93

ISO CANDELA DIAGRAM

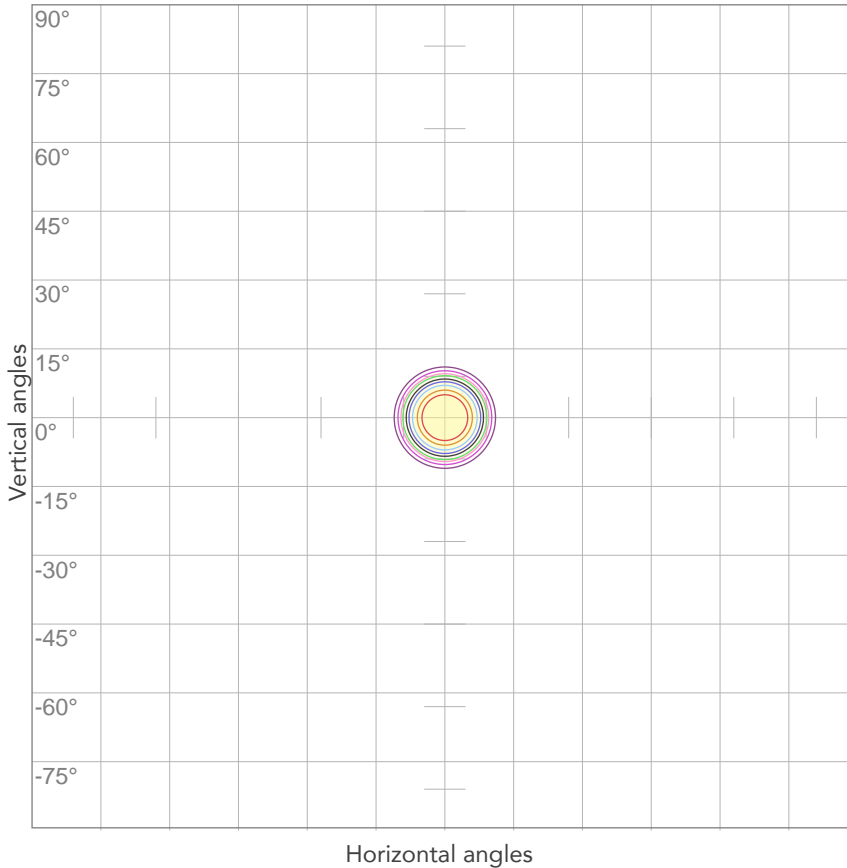

10%	3655 cd
20%	7310 cd
30%	10964 cd
40%	14619 cd
50%	18274 cd
60%	21929 cd
70%	25584 cd
80%	29238 cd

Conditions:

Number of c-planes: 2

Candela at center: 36548 cd

ISO LUX DIAGRAM

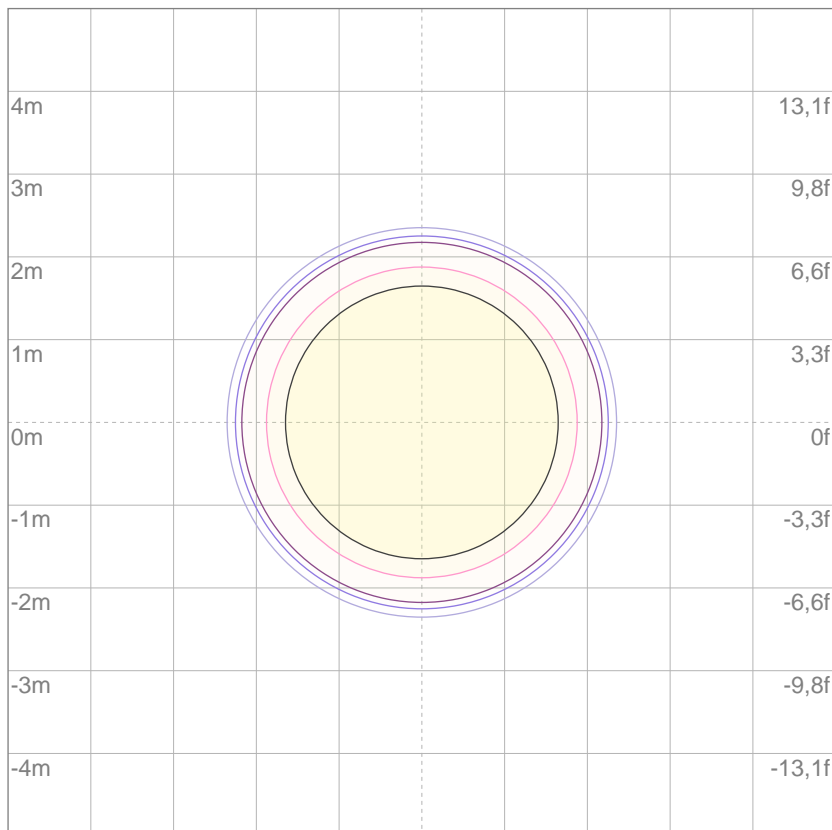

3%	11,0 lx
5%	18,3 lx
10%	36,5 lx
30%	110 lx
50%	183 lx

Conditions:

Number of c-planes: 2

Lux at center: 365 lx

Lux distribution on a surface when lamp is mounted at 10 meters from the surface.

Mounting height: 10 meters (33 feet)



Total lumen output:

2013 lm

Peak candela output:

460254 cd

PRODUCT NAME:
ASTRAWASH7PIXIP

MEASUREMENT CONDITIONS:

Beam angle:
Min Zoom

Target:
Full On Cal. Off

Operator:
Paolo Carvone

Date and time:
15/02/2021 16:37:59

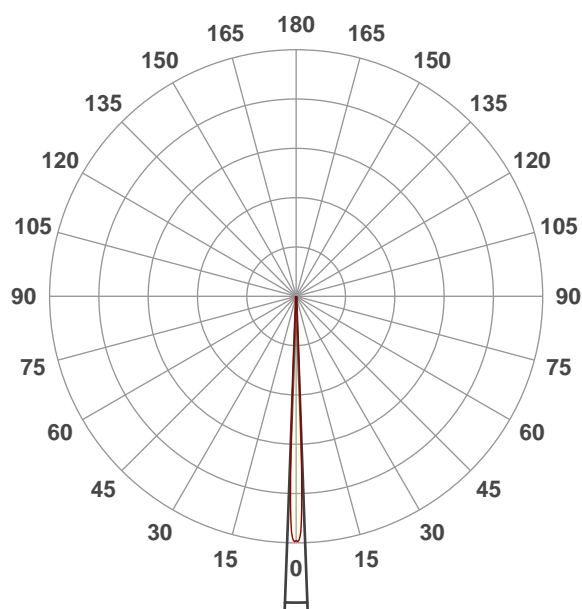

Beam angle 50%: 4,2°
Field angle 10%: 5,5°
Cut off angle 2.5%: 6,1°

Spectra

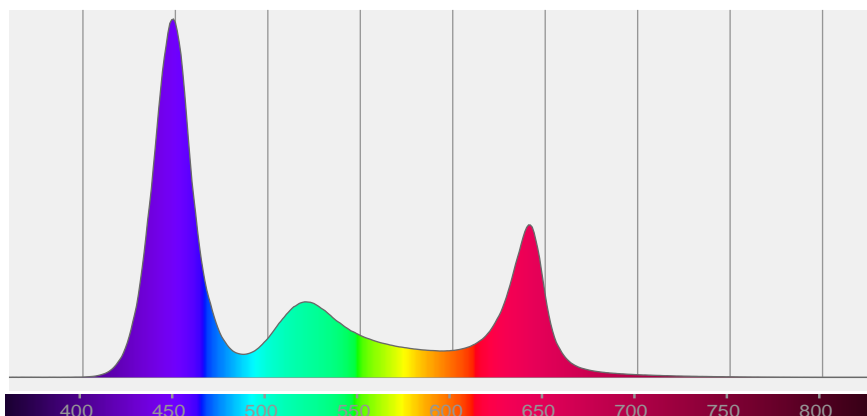

BEAM DETAILS



Beam angle 50%	Field angle 10%	Cut off angle 2,5%	Intensity ratio in 120° cone	Intensity ratio in 90° cone
4,2°	5,5°	6,1°	100,0%	100,0%

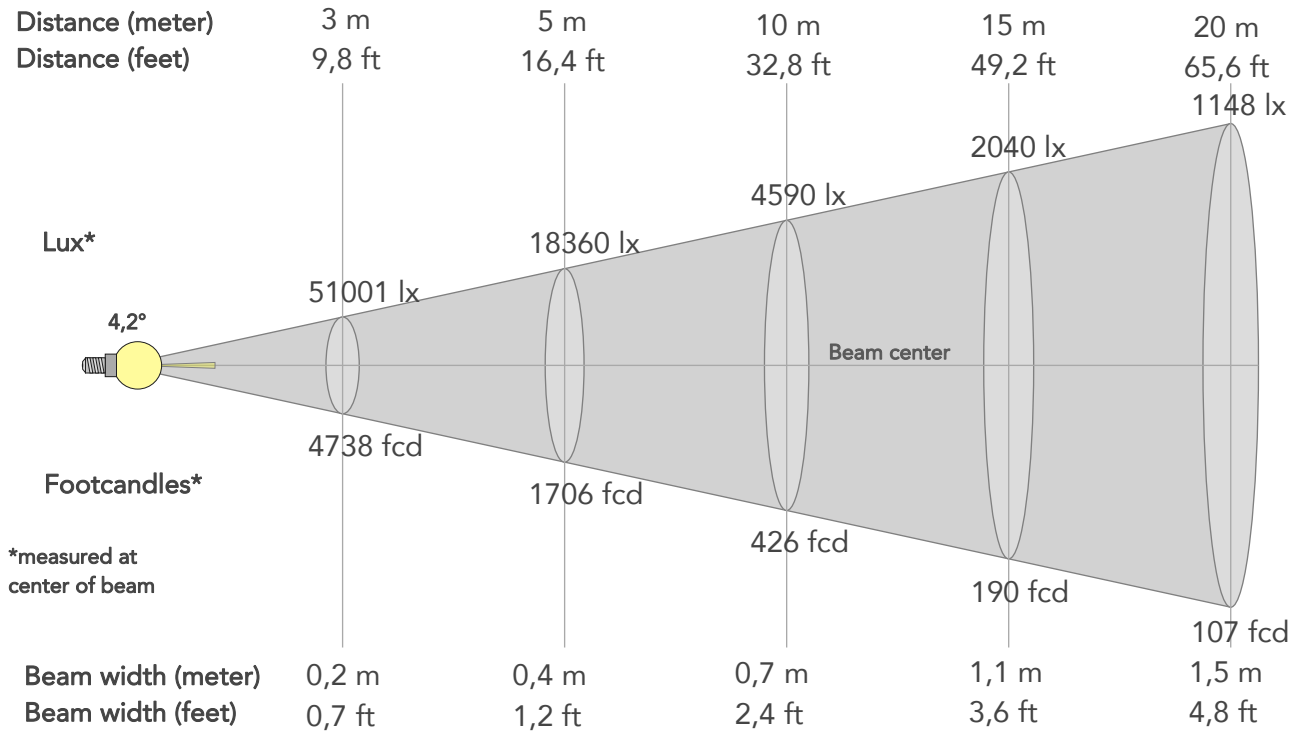

BEAM INTENSITIES AND WIDTHS

Distance	1m	2m	3m	4m	5m	7,5m	10m	15m	20m	25m	30m	40m	50m
Distance	3,3ft	6,6ft	9,8ft	13,1ft	16,4ft	24,6ft	32,8ft	49,2ft	65,6ft	82ft	98,4ft	131,2ft	164ft
Lux	459005lx	114751lx	51001lx	28688lx	18360lx	8160lx	4590lx	2040lx	1148lx	734lx	510lx	287lx	184lx
Footcand.	42643fcd	10661fcd	4738fcd	2665fcd	1706fcd	758fcd	426fcd	190fcd	107fcd	68fcd	47fcd	27fcd	17fcd
Beam wid.	0,1m	0,1m	0,2m	0,3m	0,4m	0,5m	0,7m	1,1m	1,5m	1,8m	2,2m	2,9m	3,7m
Beam wid.	0,2ft	0,5ft	0,7ft	1ft	1,2ft	1,8ft	2,4ft	3,6ft	4,8ft	6ft	7,2ft	9,6ft	12ft

LINEAR DISTRIBUTION DIAGRAM

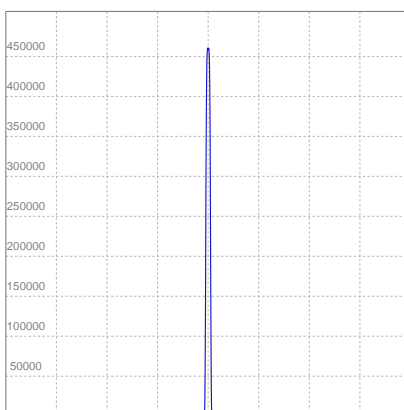

ELECTRICAL SPECIFICATIONS

Input voltage	Input current	Input power	Efficiency
223V	1,06A	220,3W	9lm/W

Power FC
0,93

ISO CANDELA DIAGRAM

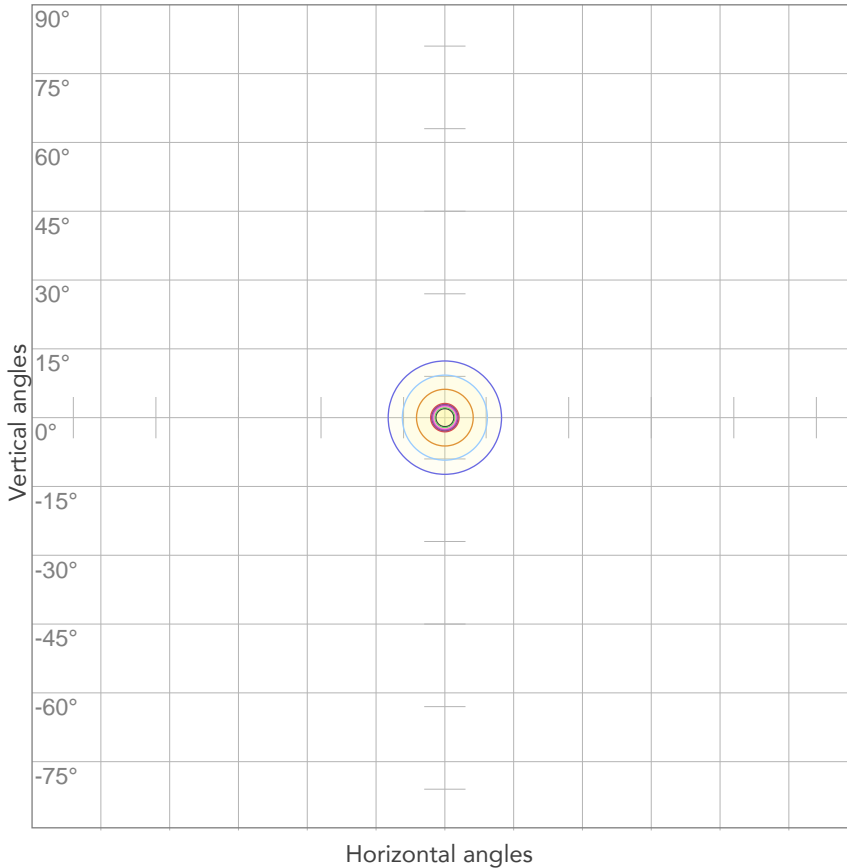

10%	45900 cd
20%	91801 cd
30%	137701 cd
40%	183602 cd
50%	229502 cd
60%	275403 cd
70%	321303 cd
80%	367204 cd

Conditions:

Number of c-planes: 2

Candela at center: 459005 cd

ISO LUX DIAGRAM

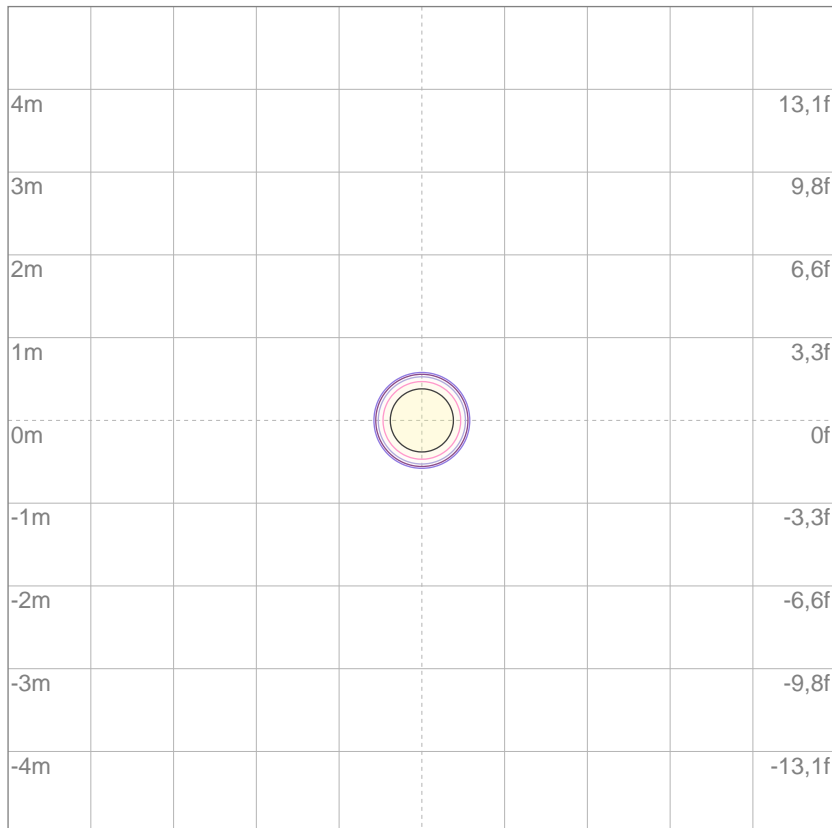

3%	138 lx
5%	230 lx
10%	459 lx
30%	1377 lx
50%	2295 lx

Conditions:

Number of c-planes: 2

Lux at center: 4590 lx

Lux distribution on a surface when lamp is mounted at 10 meters from the surface.

Mounting height: 10 meters (33 feet)



Total lumen output:

642 lm

Peak candela output:

1759 cd

PRODUCT NAME:

ASTRAWASH7PIXIP

MEASUREMENT CONDITIONS:

Beam angle:

Max Zoom

Target:

Red

Operator:

Paolo Carvone

Date and time:

15/02/2021 17:22:04

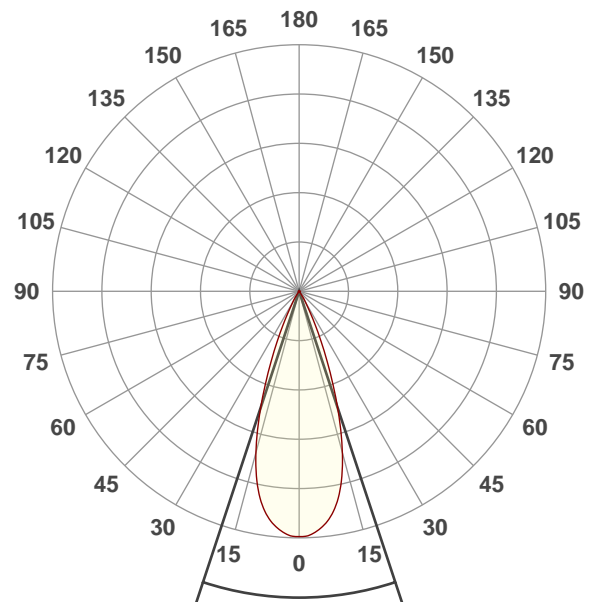

Beam angle 50%: 36,6°

Field angle 10%: 54,7°

Cut off angle 2.5%: 66,6°

Spectra

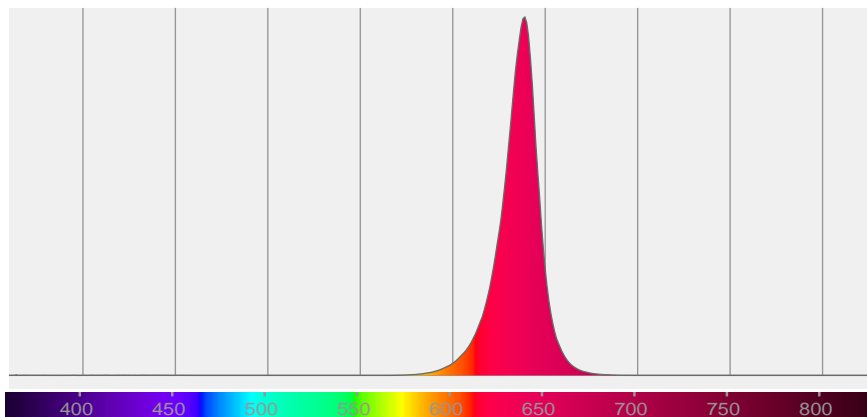

BEAM DETAILS



Beam angle 50%	Field angle 10%	Cut off angle 2,5%	Intensity ratio in 120° cone	Intensity ratio in 90° cone
36,6°	54,7°	66,6°	99,9%	99,8%

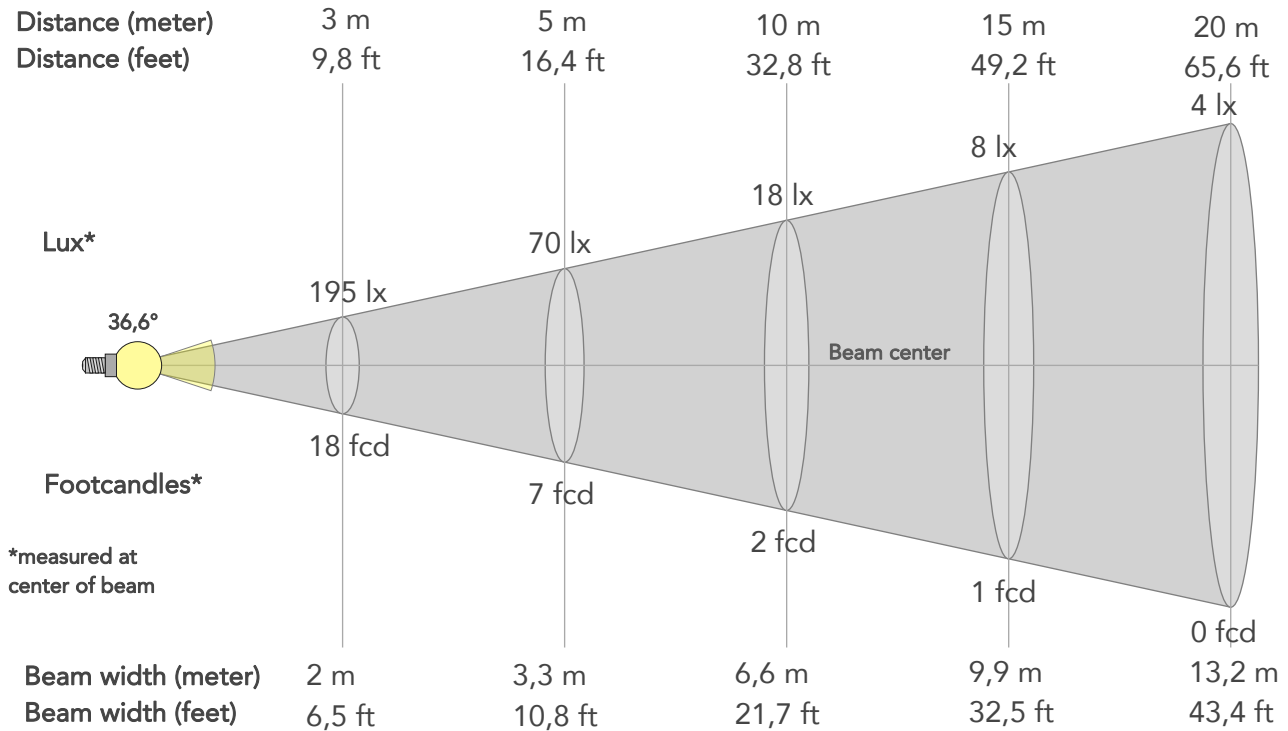

BEAM INTENSITIES AND WIDTHS

Distance	1m	2m	3m	4m	5m	7,5m	10m	15m	20m	25m	30m	40m	50m
Distance	3,3ft	6,6ft	9,8ft	13,1ft	16,4ft	24,6ft	32,8ft	49,2ft	65,6ft	82ft	98,4ft	131,2ft	164ft
Lux	1759lx	440lx	195lx	110lx	70lx	31lx	18lx	8lx	4lx	3lx	2lx	1lx	1lx
Footcand.	163fcd	41fcd	18fcd	10fcd	7fcd	3fcd	2fcd	1fcd	0fcd	0fcd	0fcd	0fcd	0fcd
Beam wid.	0,7m	1,3m	2m	2,6m	3,3m	5m	6,6m	9,9m	13,2m	16,5m	19,8m	26,4m	33,1m
Beam wid.	2,2ft	4,4ft	6,5ft	8,7ft	10,8ft	16,3ft	21,7ft	32,5ft	43,4ft	54,2ft	65ft	86,7ft	108,4ft

LINEAR DISTRIBUTION DIAGRAM

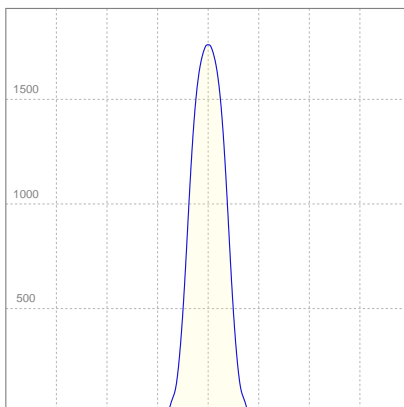

ELECTRICAL SPECIFICATIONS

Input voltage	Input current	Input power	Effeciency
223V	0,453A	79,5W	8lm/W

Power FC
0,79

ISO CANDELA DIAGRAM

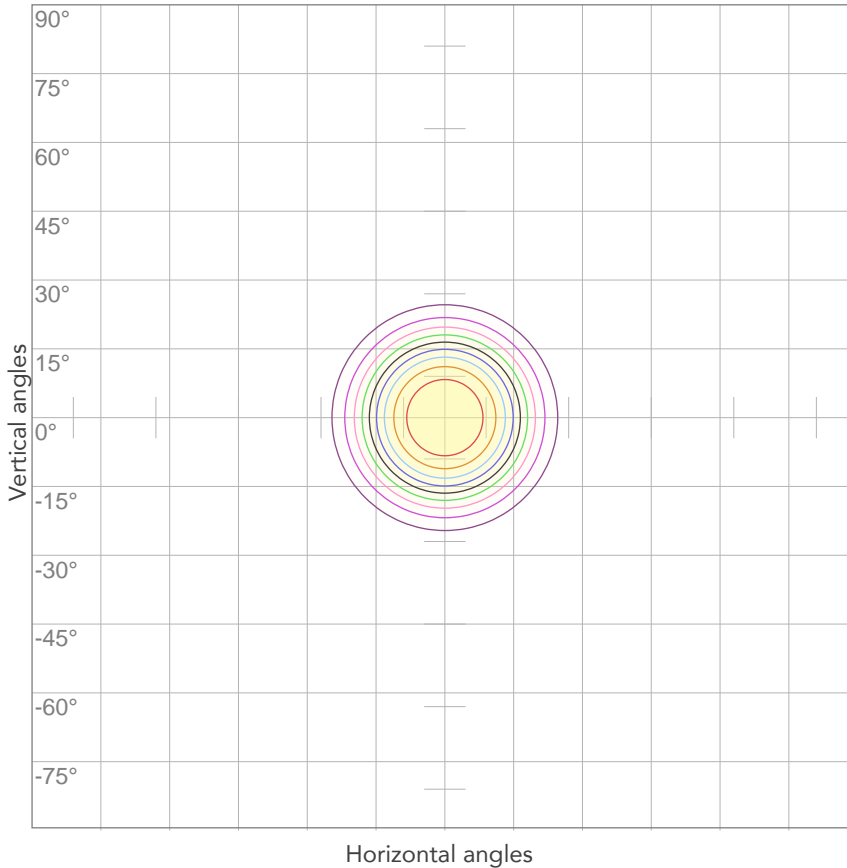

10%	176 cd
20%	352 cd
30%	528 cd
40%	703 cd
50%	879 cd
60%	1055 cd
70%	1231 cd
80%	1407 cd

Conditions:

Number of c-planes: 2

Candela at center: 1759 cd

ISO LUX DIAGRAM

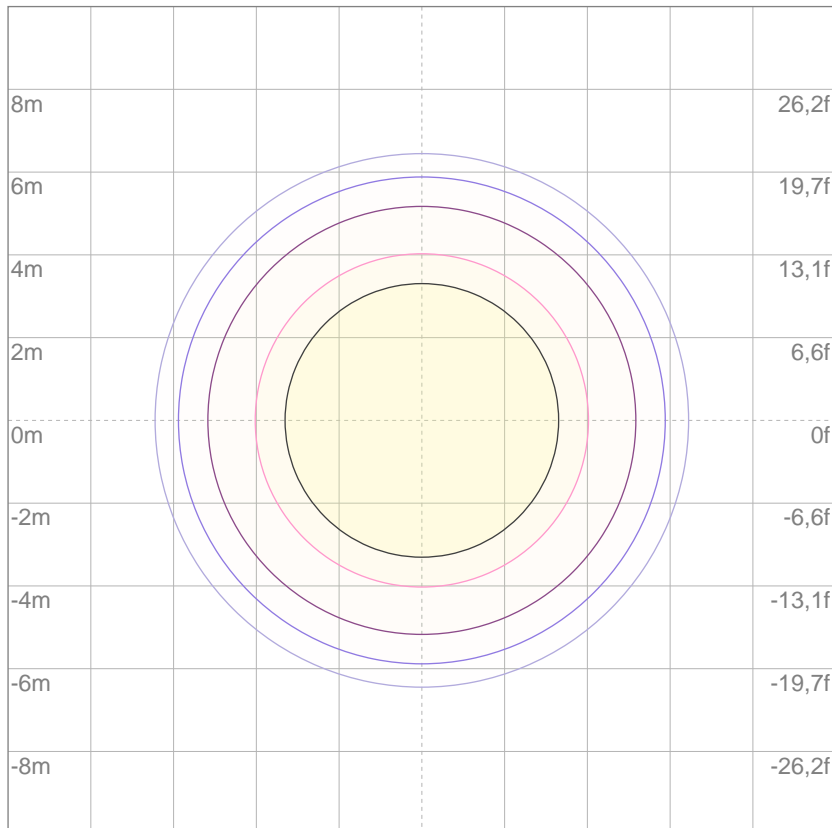

3%	0,528 lx
5%	0,879 lx
10%	1,76 lx
30%	5,28 lx
50%	8,79 lx

Conditions:

Number of c-planes: 2

Lux at center: 17,6 lx

Lux distribution on a surface when lamp is mounted at 10 meters from the surface.

Mounting height: 10 meters (33 feet)



Total lumen output:

562 lm

Peak candela output:

6712 cd

PRODUCT NAME:

ASTRAWASH7PIXIP

MEASUREMENT CONDITIONS:

Beam angle:

Med Zoom

Target:

Red

Operator:

Paolo Carvone

Date and time:

15/02/2021 17:17:54

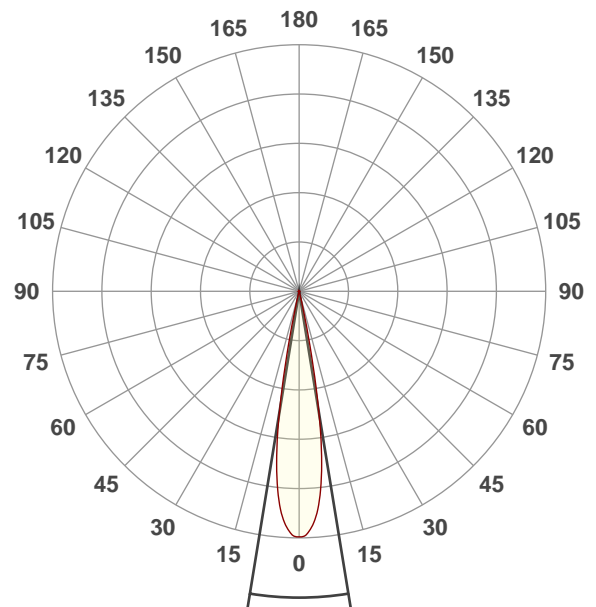

Beam angle 50%: 18,5°

Field angle 10%: 24,8°

Cut off angle 2.5%: 27,3°

Spectra

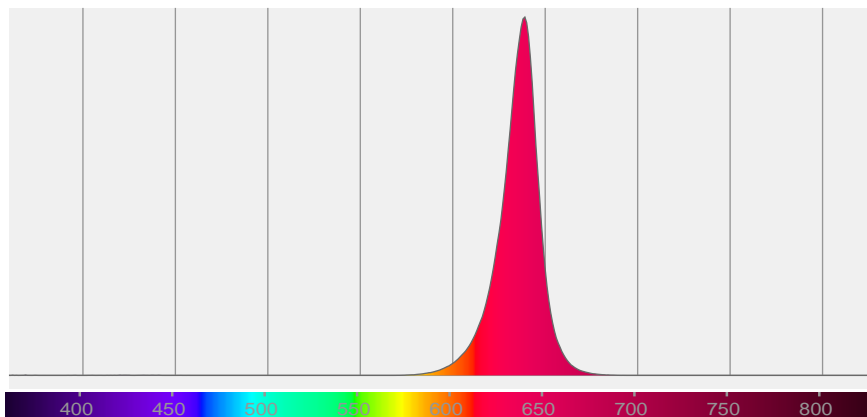

BEAM DETAILS



Beam angle 50%	Field angle 10%	Cut off angle 2,5%	Intensity ratio in 120° cone	Intensity ratio in 90° cone
18,5°	24,8°	27,3°	100,0%	100,0%

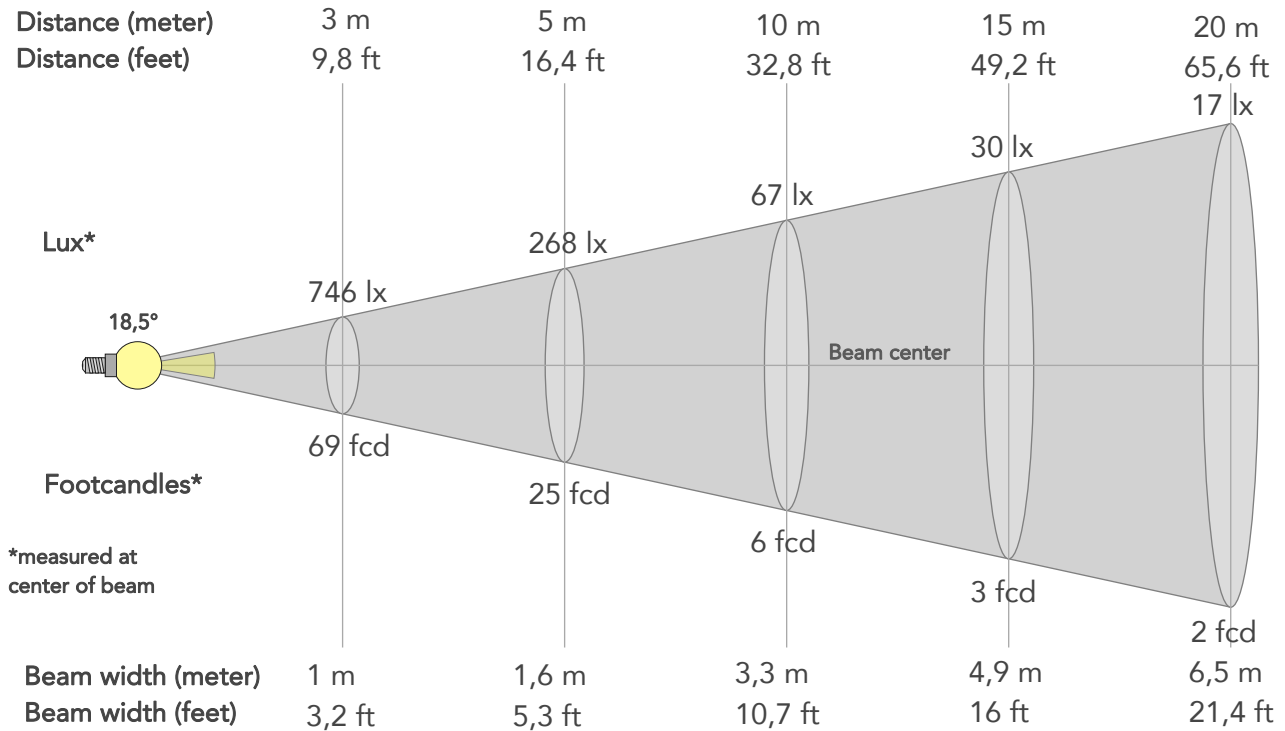

BEAM INTENSITIES AND WIDTHS

Distance	1m	2m	3m	4m	5m	7,5m	10m	15m	20m	25m	30m	40m	50m
Distance	3,3ft	6,6ft	9,8ft	13,1ft	16,4ft	24,6ft	32,8ft	49,2ft	65,6ft	82ft	98,4ft	131,2ft	164ft
Lux	6712lx	1678lx	746lx	419lx	268lx	119lx	67lx	30lx	17lx	11lx	7lx	4lx	3lx
Footcand.	624fcd	156fcd	69fcd	39fcd	25fcd	11fcd	6fcd	3fcd	2fcd	1fcd	1fcd	0fcd	0fcd
Beam wid.	0,3m	0,7m	1m	1,3m	1,6m	2,4m	3,3m	4,9m	6,5m	8,1m	9,8m	13m	16,3m
Beam wid.	1,1ft	2,2ft	3,2ft	4,3ft	5,3ft	8ft	10,7ft	16ft	21,4ft	26,7ft	32,1ft	42,7ft	53,4ft

LINEAR DISTRIBUTION DIAGRAM

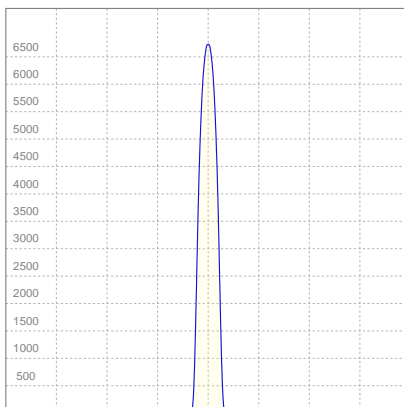

ELECTRICAL SPECIFICATIONS

Input voltage	Input current	Input power	Efficiency
222V	0,457A	80,6W	7lm/W

Power FC
0,79

ISO CANDELA DIAGRAM

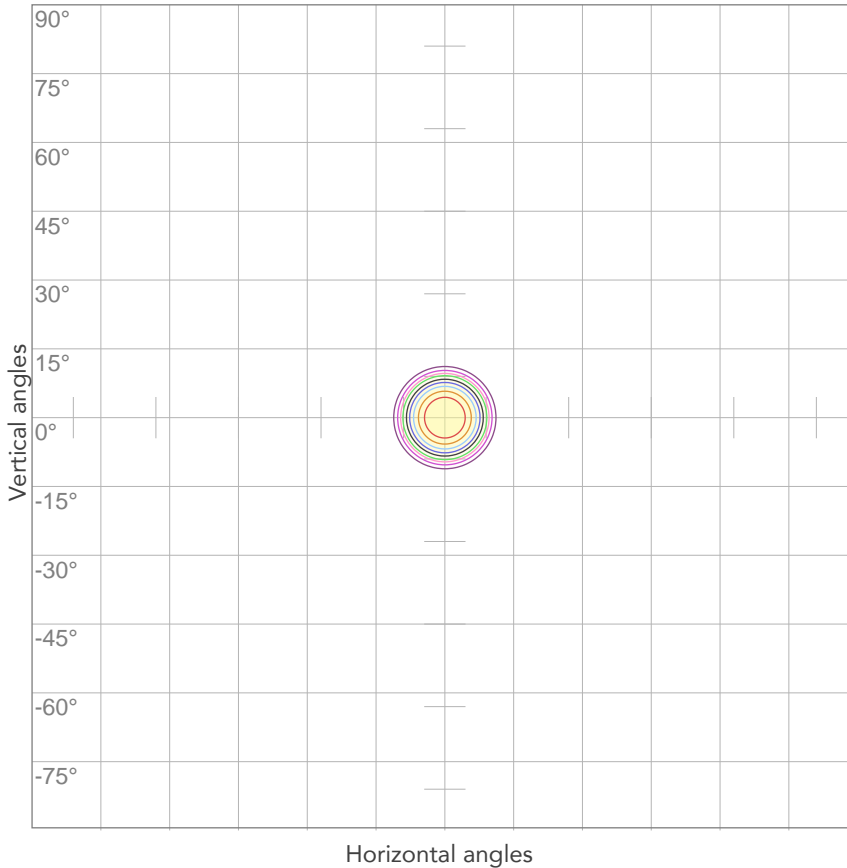

10%	671 cd
20%	1342 cd
30%	2014 cd
40%	2685 cd
50%	3356 cd
60%	4027 cd
70%	4698 cd
80%	5369 cd

Conditions:

Number of c-planes: 2

Candela at center: 6712 cd

ISO LUX DIAGRAM

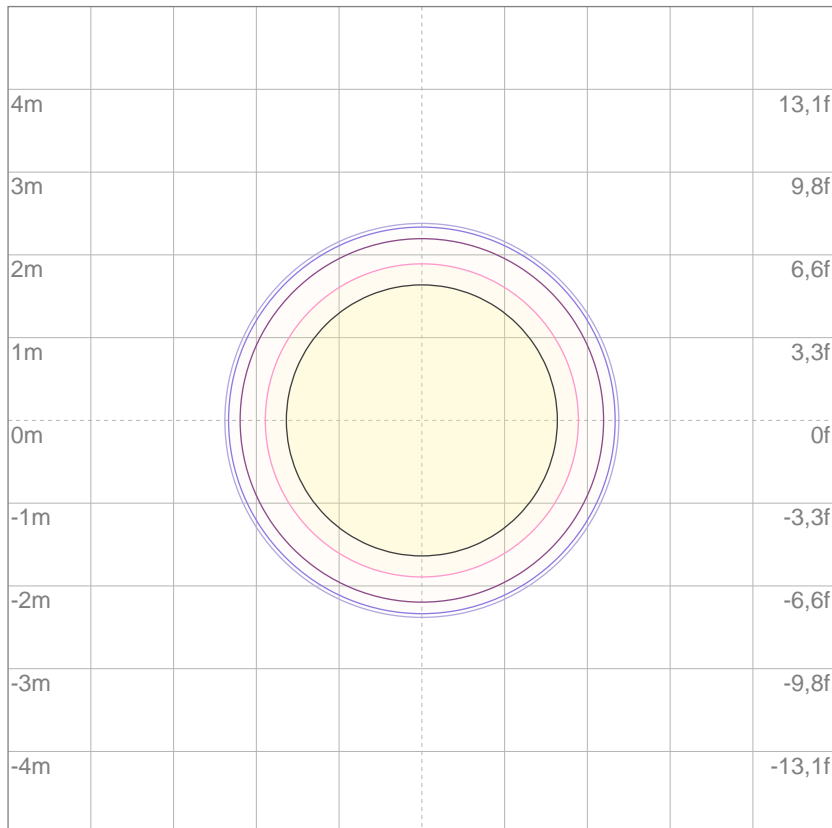

3%	2,01 lx
5%	3,36 lx
10%	6,71 lx
30%	20,1 lx
50%	33,6 lx

Conditions:

Number of c-planes: 2

Lux at center: 67,1 lx

Lux distribution on a surface when lamp is mounted at 10 meters from the surface.

Mounting height: 10 meters (33 feet)



Total lumen output:

365 lm

Peak candela output:

84375 cd

PRODUCT NAME:

ASTRAWASH7PIXIP

MEASUREMENT CONDITIONS:

Beam angle:

Min Zoom

Target:

Red

Operator:

Paolo Carvone

Date and time:

15/02/2021 17:20:18

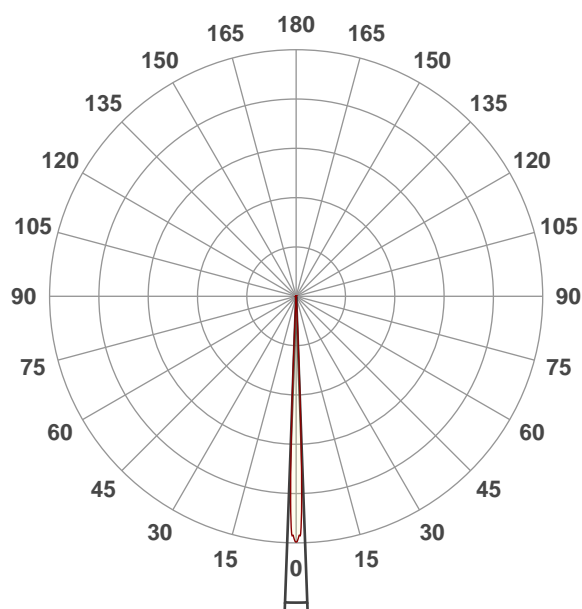

Beam angle 50%: 4,2°

Field angle 10%: 5,5°

Cut off angle 2.5%: 6,1°

Spectra

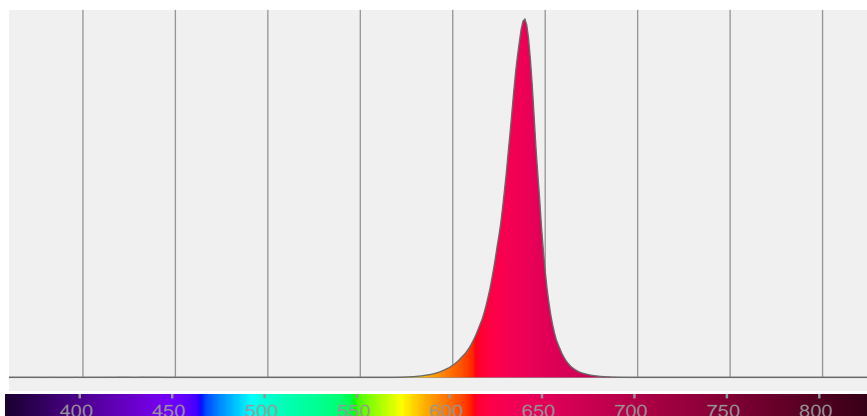

BEAM DETAILS



Beam angle 50%	Field angle 10%	Cut off angle 2,5%	Intensity ratio in 120° cone	Intensity ratio in 90° cone
4,2°	5,5°	6,1°	99,9%	99,8%

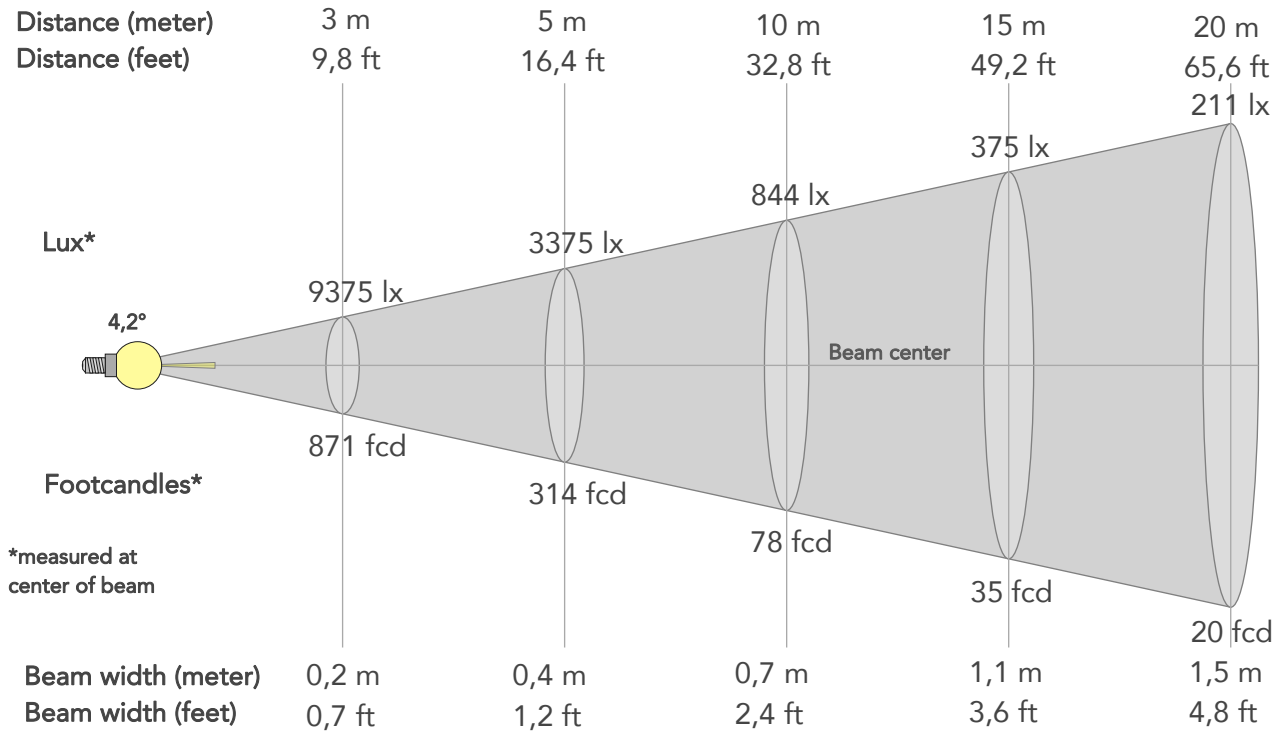

BEAM INTENSITIES AND WIDTHS

Distance	1m	2m	3m	4m	5m	7,5m	10m	15m	20m	25m	30m	40m	50m
Distance	3,3ft	6,6ft	9,8ft	13,1ft	16,4ft	24,6ft	32,8ft	49,2ft	65,6ft	82ft	98,4ft	131,2ft	164ft
Lux	84375lx	21094lx	9375lx	5273lx	3375lx	1500lx	844lx	375lx	211lx	135lx	94lx	53lx	34lx
Footcand.	7839fcd	1960fcd	871fcd	490fcd	314fcd	139fcd	78fcd	35fcd	20fcd	13fcd	9fcd	5fcd	3fcd
Beam wid.	0,1m	0,1m	0,2m	0,3m	0,4m	0,5m	0,7m	1,1m	1,5m	1,8m	2,2m	2,9m	3,6m
Beam wid.	0,2ft	0,5ft	0,7ft	1ft	1,2ft	1,8ft	2,4ft	3,6ft	4,8ft	6ft	7,2ft	9,5ft	11,9ft

LINEAR DISTRIBUTION DIAGRAM

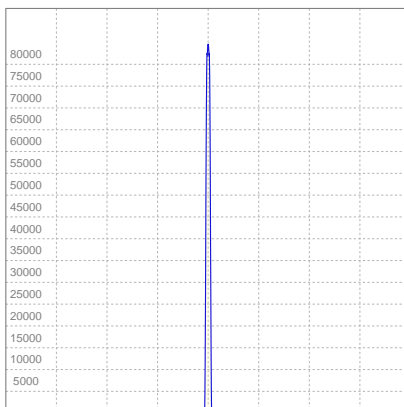

ELECTRICAL SPECIFICATIONS

Input voltage	Input current	Input power	Effeciency
222V	0,453A	79,7W	5lm/W

Power FC
0,79

ISO CANDELA DIAGRAM

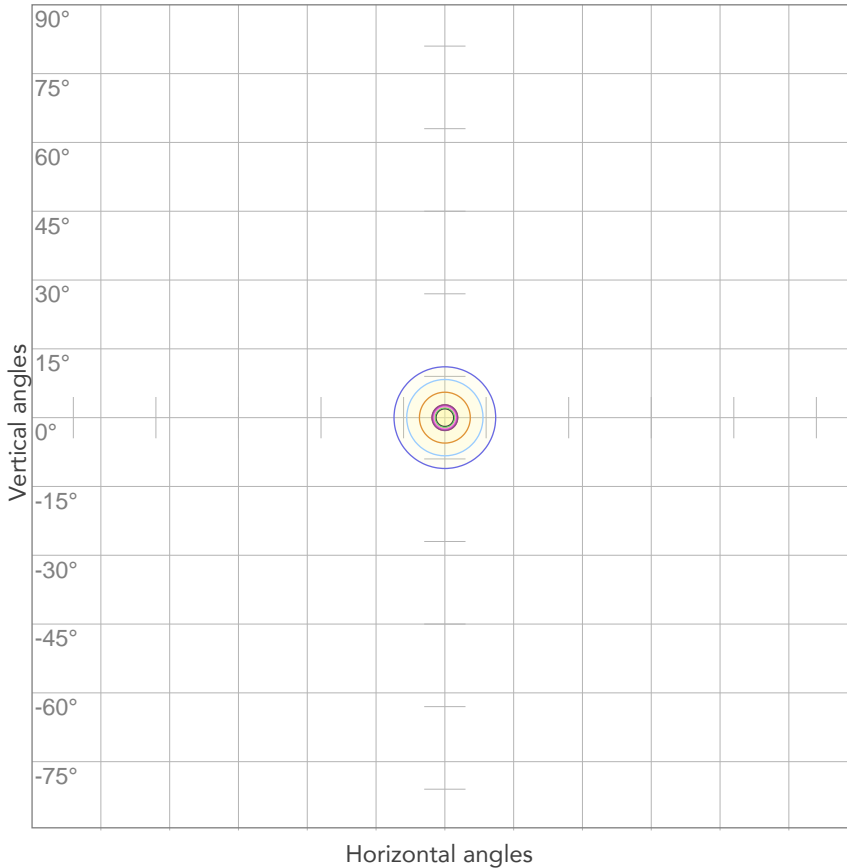

10%	8438 cd
20%	16875 cd
30%	25313 cd
40%	33750 cd
50%	42188 cd
60%	50625 cd
70%	59063 cd
80%	67500 cd

Conditions:

Number of c-planes: 2

Candela at center: 84375 cd

ISO LUX DIAGRAM

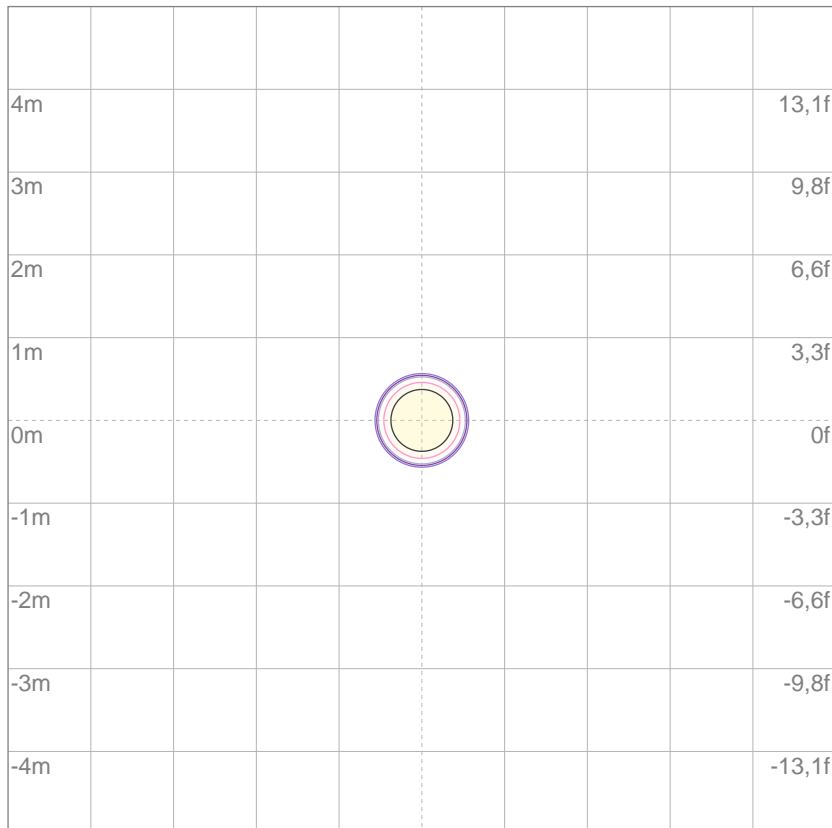

Mounting height: 10 meters (33 feet)

3%	25,3 lx
5%	42,2 lx
10%	84,4 lx
30%	253 lx
50%	422 lx

Conditions:

Number of c-planes: 2

Lux at center: 844 lx

Lux distribution on a surface when lamp is mounted at 10 meters from the surface.



Total lumen output:

1168 lm

Peak candela output:

3110 cd

PRODUCT NAME:

ASTRAWASH7PIXIP

MEASUREMENT CONDITIONS:

Beam angle:

Max Zoom

Target:

Green

Operator:

Paolo Carvone

Date and time:

15/02/2021 17:28:00

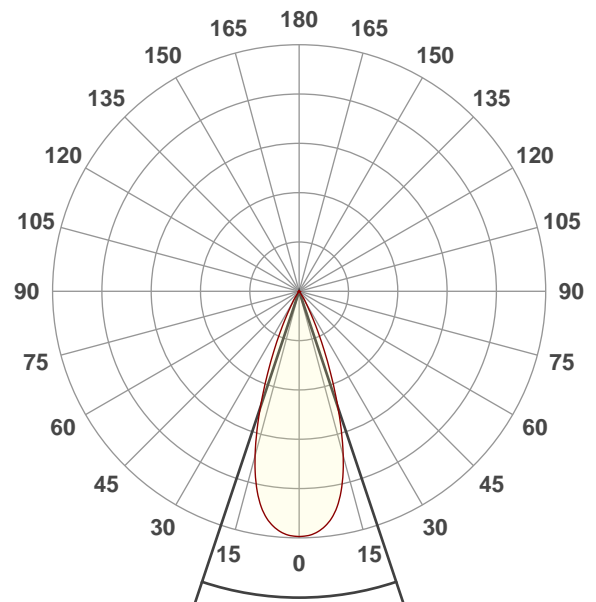

Beam angle 50%: 37°

Field angle 10%: 55,5°

Cut off angle 2.5%: 67,1°

Spectra

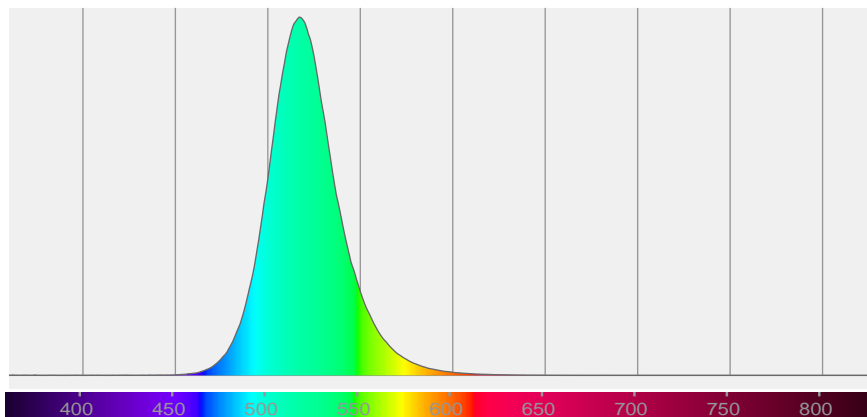

BEAM DETAILS



Beam angle 50%	Field angle 10%	Cut off angle 2,5%	Intensity ratio in 120° cone	Intensity ratio in 90° cone
37°	55,5°	67,1°	99,8%	99,6%

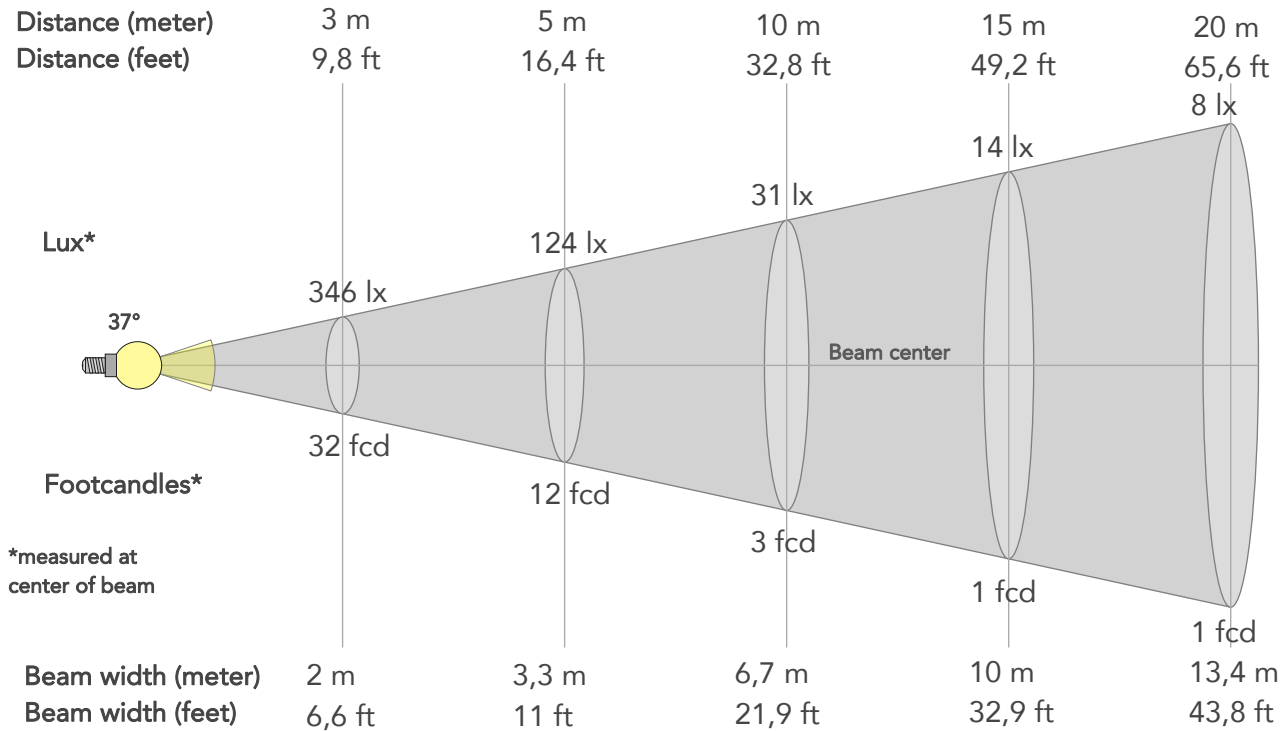

BEAM INTENSITIES AND WIDTHS

Distance	1m	2m	3m	4m	5m	7,5m	10m	15m	20m	25m	30m	40m	50m
Distance	3,3ft	6,6ft	9,8ft	13,1ft	16,4ft	24,6ft	32,8ft	49,2ft	65,6ft	82ft	98,4ft	131,2ft	164ft
Lux	3110lx	777lx	346lx	194lx	124lx	55lx	31lx	14lx	8lx	5lx	3lx	2lx	1lx
Footcand.	289fcd	72fcd	32fcd	18fcd	12fcd	5fcd	3fcd	1fcd	1fcd	0fcd	0fcd	0fcd	0fcd
Beam wid.	0,7m	1,3m	2m	2,7m	3,3m	5m	6,7m	10m	13,4m	16,7m	20,1m	26,7m	33,4m
Beam wid.	2,2ft	4,4ft	6,6ft	8,8ft	11ft	16,4ft	21,9ft	32,9ft	43,8ft	54,8ft	65,8ft	87,7ft	109,6ft

LINEAR DISTRIBUTION DIAGRAM

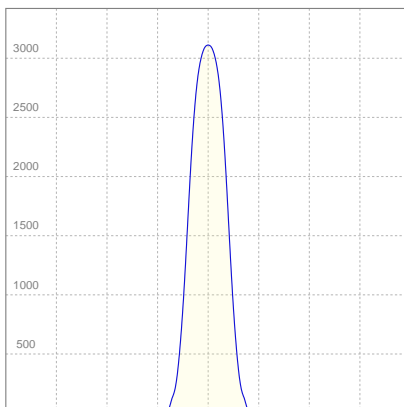

ELECTRICAL SPECIFICATIONS

Input voltage	Input current	Input power	Effeciency
222V	0,543A	100,2W	12lm/W

Power FC
0,83

ISO CANDELA DIAGRAM

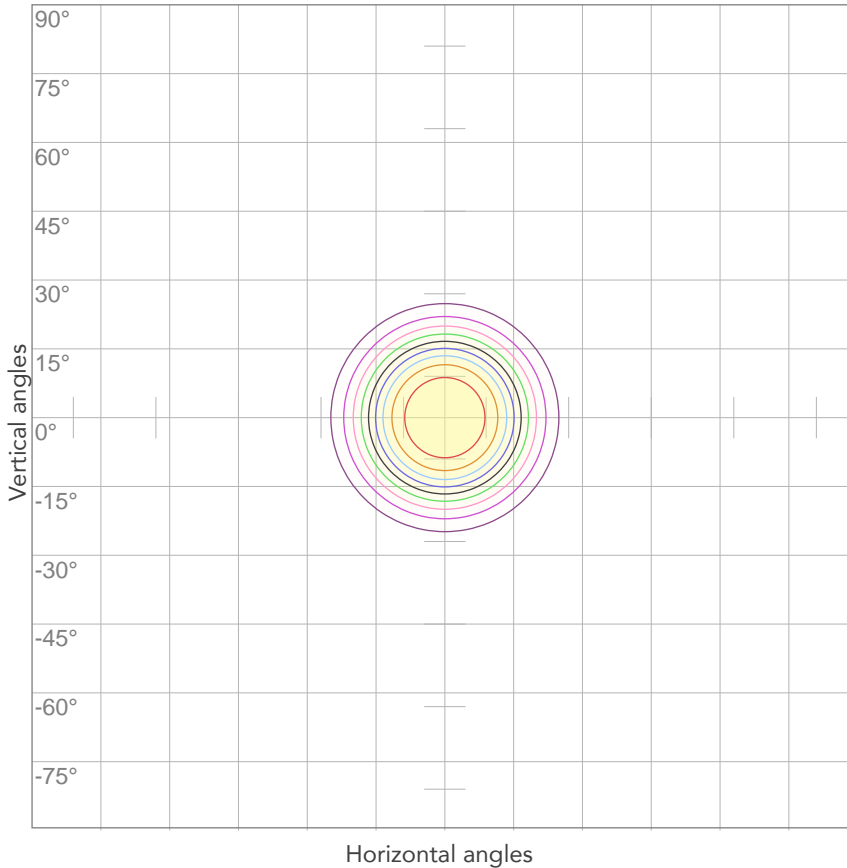

10%	311 cd
20%	622 cd
30%	933 cd
40%	1244 cd
50%	1555 cd
60%	1866 cd
70%	2177 cd
80%	2488 cd

Conditions:

Number of c-planes: 2

Candela at center: 3110 cd

ISO LUX DIAGRAM

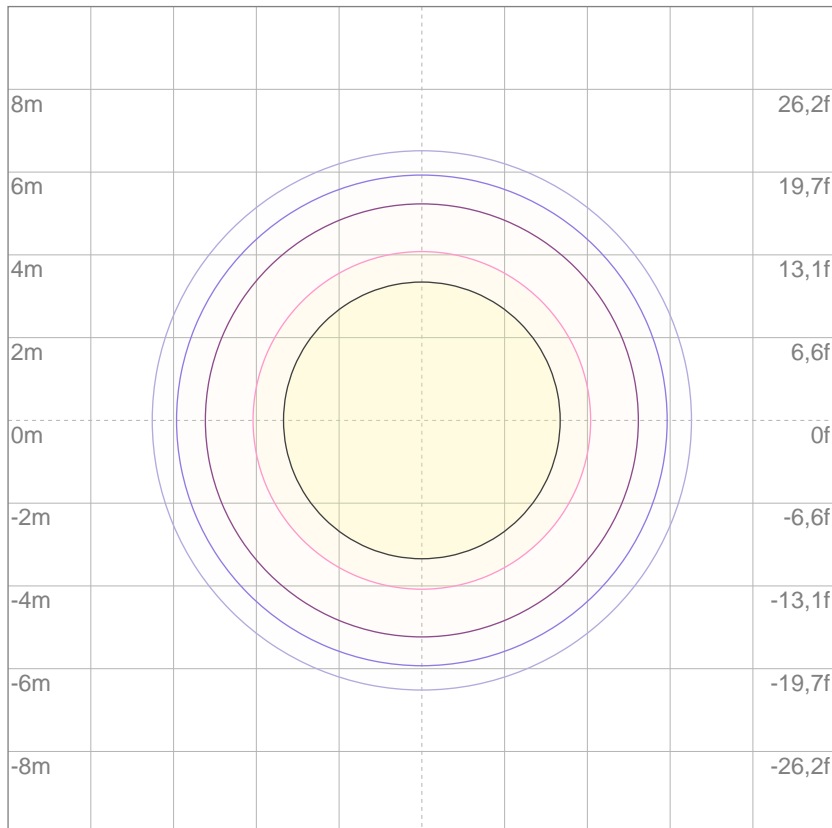

3%	0,933 lx
5%	1,55 lx
10%	3,11 lx
30%	9,33 lx
50%	15,5 lx

Conditions:

Number of c-planes: 2

Lux at center: 31,1 lx

Lux distribution on a surface when lamp is mounted at 10 meters from the surface.

Mounting height: 10 meters (33 feet)



Total lumen output:

1028 lm

Peak candela output:

11777 cd

PRODUCT NAME:

ASTRAWASH7PIXIP

MEASUREMENT CONDITIONS:

Beam angle:

Med Zoom

Target:

Green

Operator:

Paolo Carvone

Date and time:

15/02/2021 17:25:54

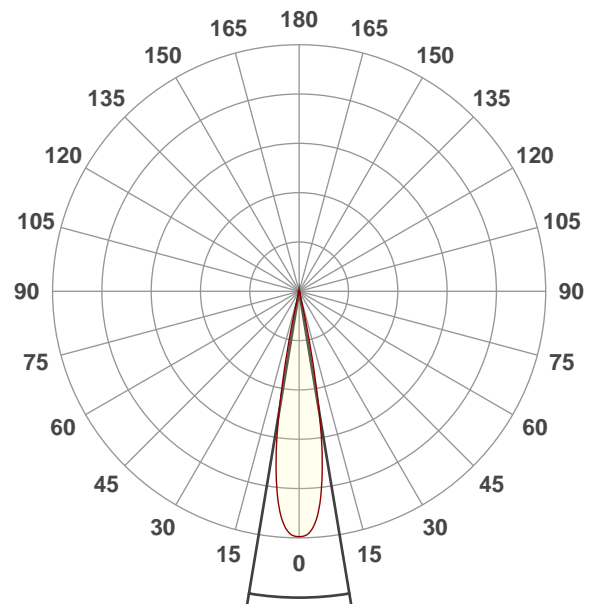

Beam angle 50%: 18,9°

Field angle 10%: 25,4°

Cut off angle 2.5%: 27,9°

Spectra

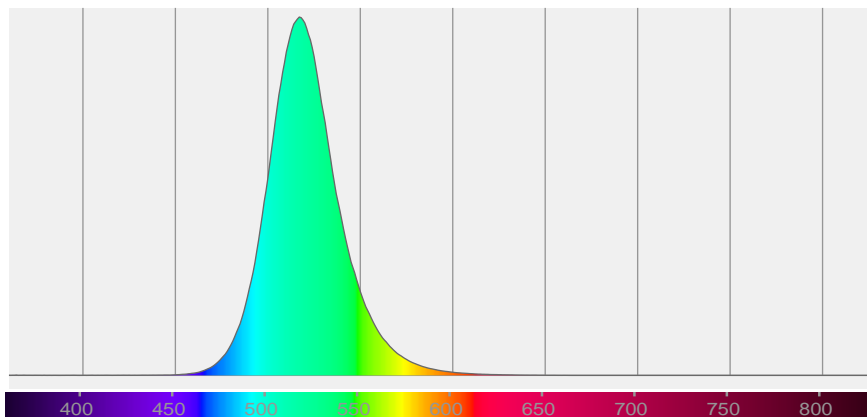

BEAM DETAILS



Beam angle 50%	Field angle 10%	Cut off angle 2,5%	Intensity ratio in 120° cone	Intensity ratio in 90° cone
18,9°	25,4°	27,9°	100,0%	99,9%

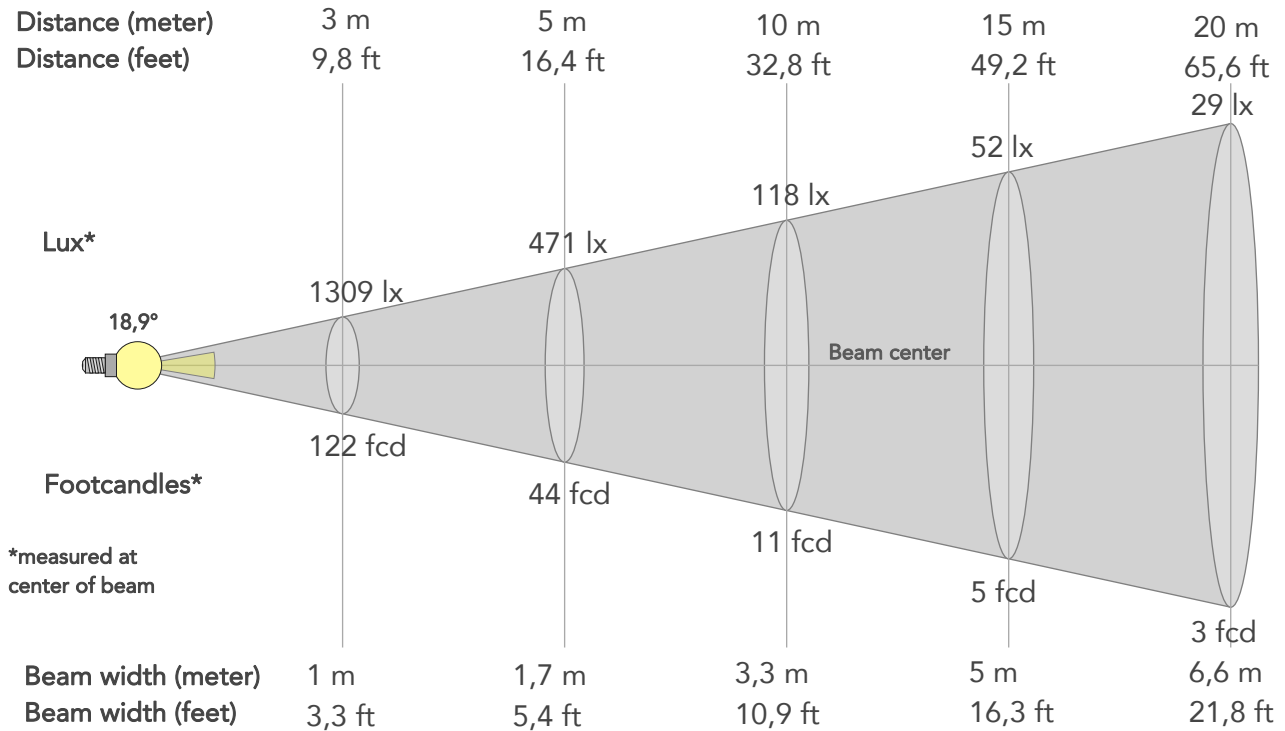

BEAM INTENSITIES AND WIDTHS

Distance	1m	2m	3m	4m	5m	7,5m	10m	15m	20m	25m	30m	40m	50m
Distance	3,3ft	6,6ft	9,8ft	13,1ft	16,4ft	24,6ft	32,8ft	49,2ft	65,6ft	82ft	98,4ft	131,2ft	164ft
Lux	11777lx	2944lx	1309lx	736lx	471lx	209lx	118lx	52lx	29lx	19lx	13lx	7lx	5lx
Footcand.	1094fcd	274fcd	122fcd	68fcd	44fcd	19fcd	11fcd	5fcd	3fcd	2fcd	1fcd	1fcd	0fcd
Beam wid.	0,3m	0,7m	1m	1,3m	1,7m	2,5m	3,3m	5m	6,6m	8,3m	10m	13,3m	16,6m
Beam wid.	1,1ft	2,2ft	3,3ft	4,4ft	5,4ft	8,2ft	10,9ft	16,3ft	21,8ft	27,2ft	32,7ft	43,6ft	54,5ft

LINEAR DISTRIBUTION DIAGRAM

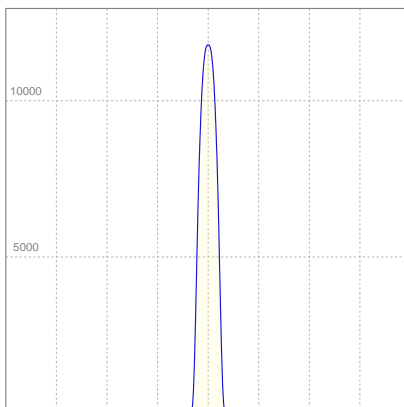

ELECTRICAL SPECIFICATIONS

Input voltage	Input current	Input power	Effeciency
221V	0,543A	100,2W	10lm/W

Power FC
0,83

ISO CANDELA DIAGRAM

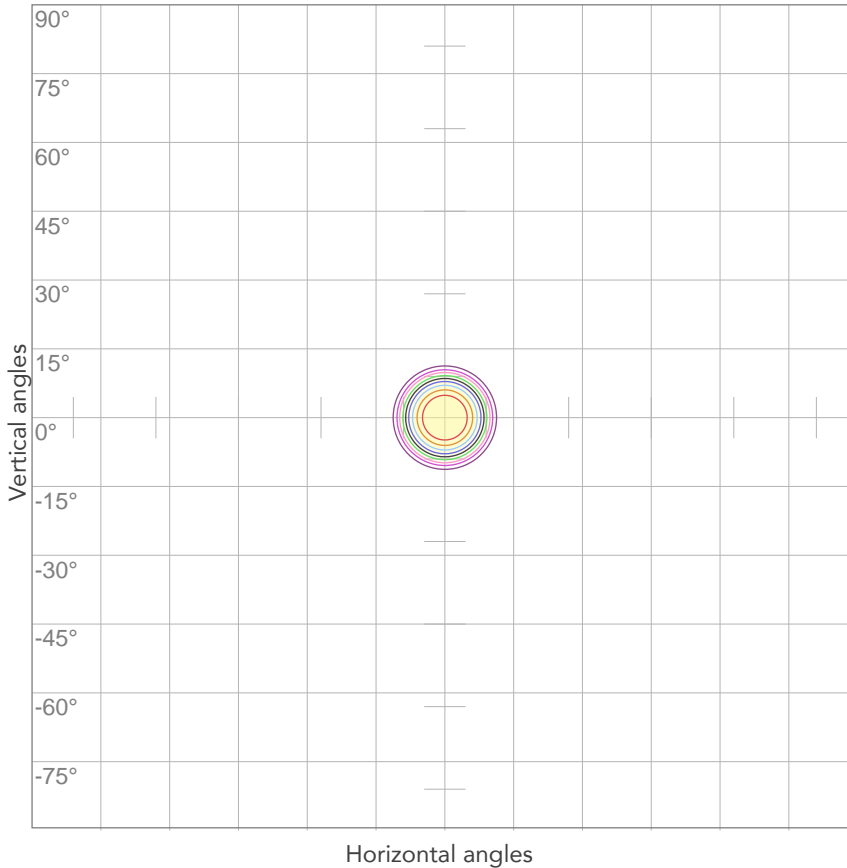

10%	1178 cd
20%	2355 cd
30%	3533 cd
40%	4711 cd
50%	5889 cd
60%	7066 cd
70%	8244 cd
80%	9422 cd

Conditions:

Number of c-planes: 2

Candela at center: 11777 cd

ISO LUX DIAGRAM

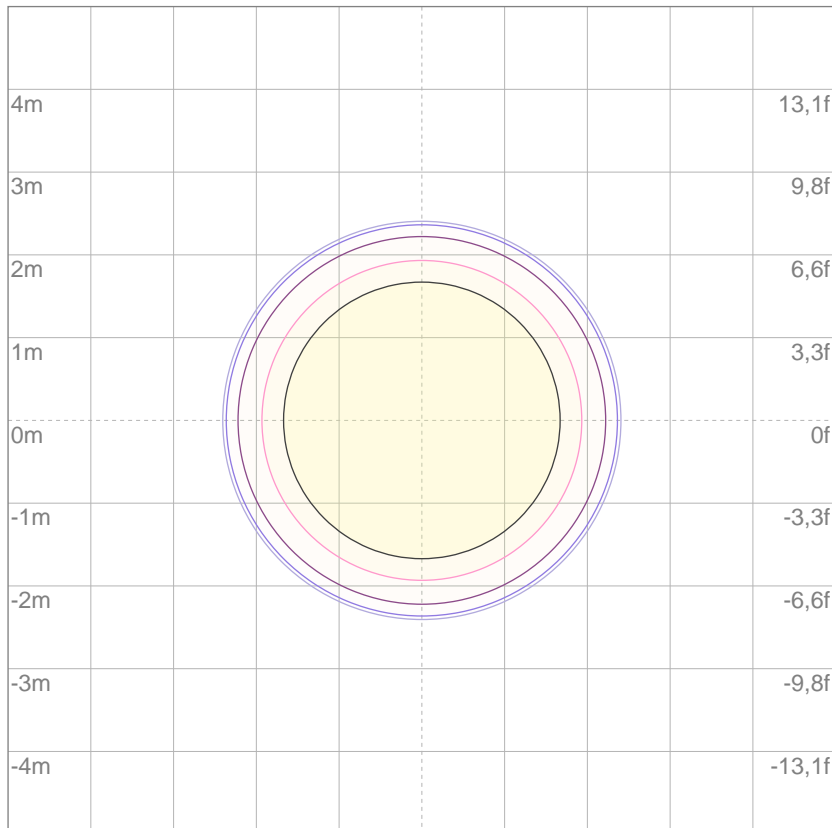

3%	3,53 lx
5%	5,89 lx
10%	11,8 lx
30%	35,3 lx
50%	58,9 lx

Conditions:

Number of c-planes: 2

Lux at center: 118 lx

Lux distribution on a surface when lamp is mounted at 10 meters from the surface.

Mounting height: 10 meters (33 feet)



Total lumen output:

694 lm

Peak candela output:

146784 cd

PRODUCT NAME:

ASTRAWASH7PIXIP

MEASUREMENT CONDITIONS:

Beam angle:

Min Zoom

Target:

Green

Operator:

Paolo Carvone

Date and time:

16/02/2021 09:29:00

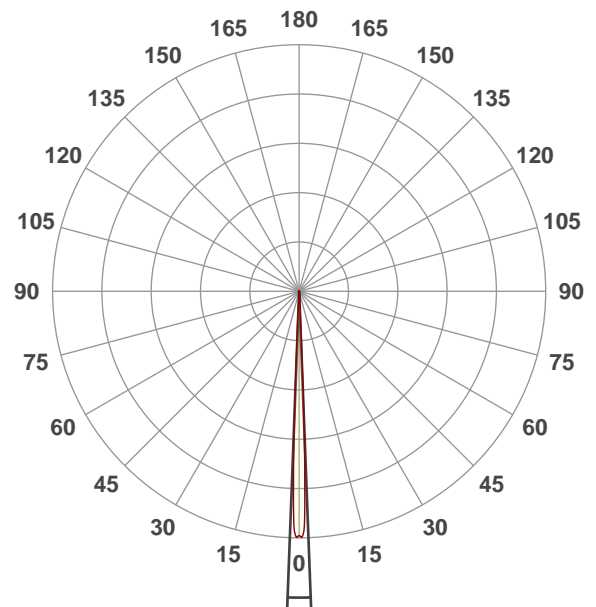

Beam angle 50%: 4,3°

Field angle 10%: 5,9°

Cut off angle 2.5%: 6,4°

Spectra

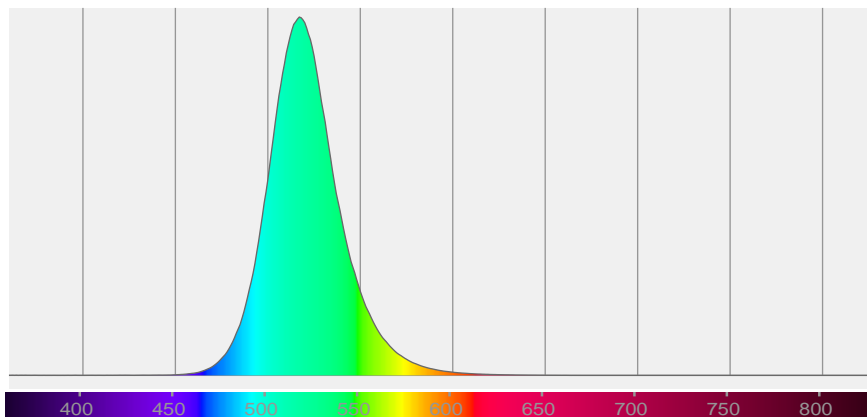

BEAM DETAILS



Beam angle 50%	Field angle 10%	Cut off angle 2,5%	Intensity ratio in 120° cone	Intensity ratio in 90° cone
4,3°	5,9°	6,4°	100,0%	100,0%

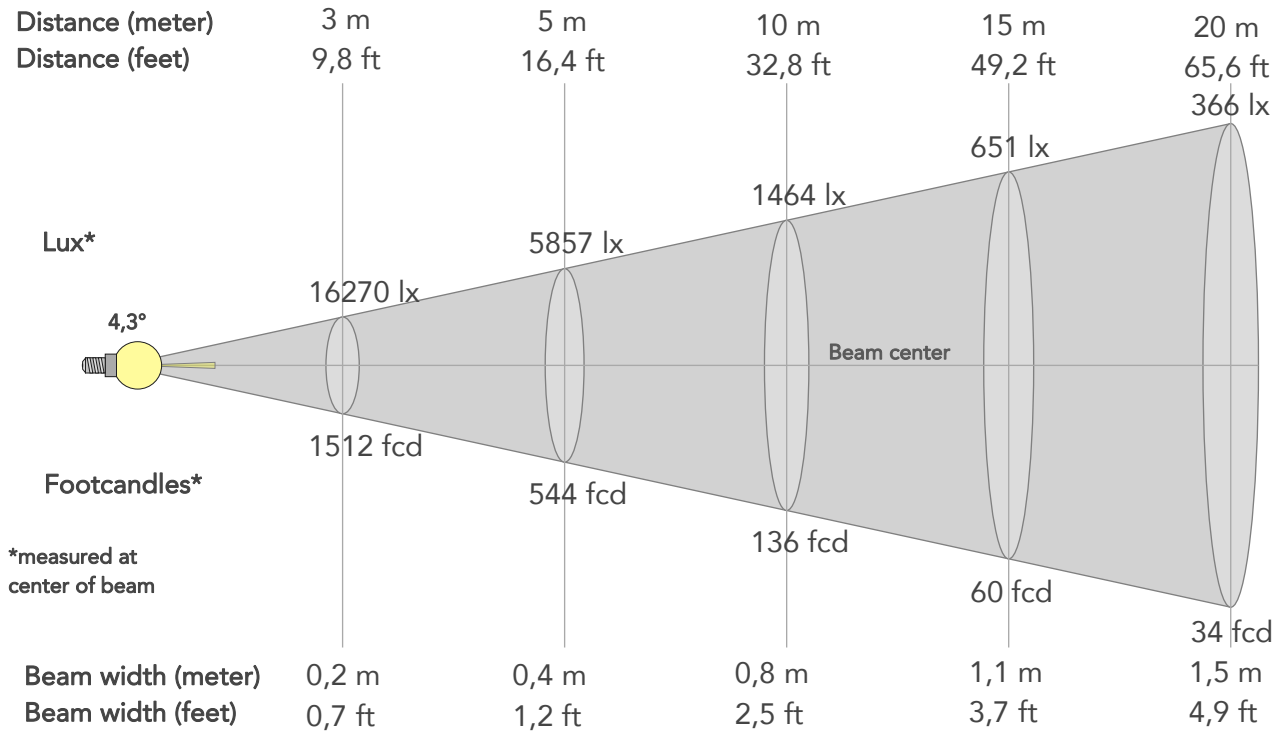

BEAM INTENSITIES AND WIDTHS

Distance	1m	2m	3m	4m	5m	7,5m	10m	15m	20m	25m	30m	40m	50m
Distance	3,3ft	6,6ft	9,8ft	13,1ft	16,4ft	24,6ft	32,8ft	49,2ft	65,6ft	82ft	98,4ft	131,2ft	164ft
Lux	146431lx	36608lx	16270lx	9152lx	5857lx	2603lx	1464lx	651lx	366lx	234lx	163lx	92lx	59lx
Footcand.	13604fcd	3401fcd	1512fcd	850fcd	544fcd	242fcd	136fcd	60fcd	34fcd	22fcd	15fcd	9fcd	5fcd
Beam wid.	0,1m	0,2m	0,2m	0,3m	0,4m	0,6m	0,8m	1,1m	1,5m	1,9m	2,3m	3m	3,8m
Beam wid.	0,2ft	0,5ft	0,7ft	1ft	1,2ft	1,9ft	2,5ft	3,7ft	4,9ft	6,2ft	7,4ft	9,9ft	12,4ft

LINEAR DISTRIBUTION DIAGRAM

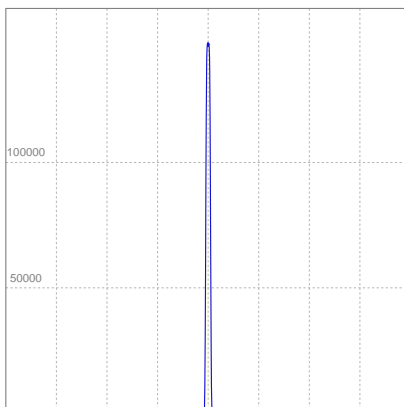

ELECTRICAL SPECIFICATIONS

Input voltage	Input current	Input power	Effeciency
222V	0,561A	103,3W	7lm/W

Power FC
0,83

ISO CANDELA DIAGRAM

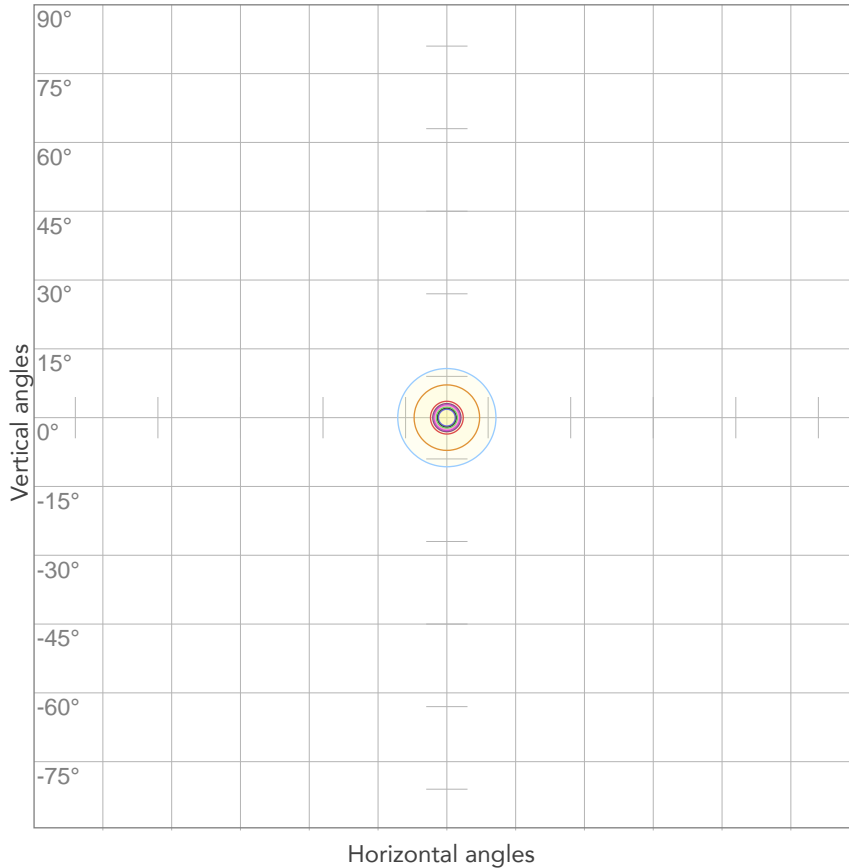

10%	14643 cd
20%	29286 cd
30%	43929 cd
40%	58573 cd
50%	73216 cd
60%	87859 cd
70%	102502 cd
80%	117145 cd

Conditions:

Number of c-planes: 2

Candela at center: 146431 cd

ISO LUX DIAGRAM

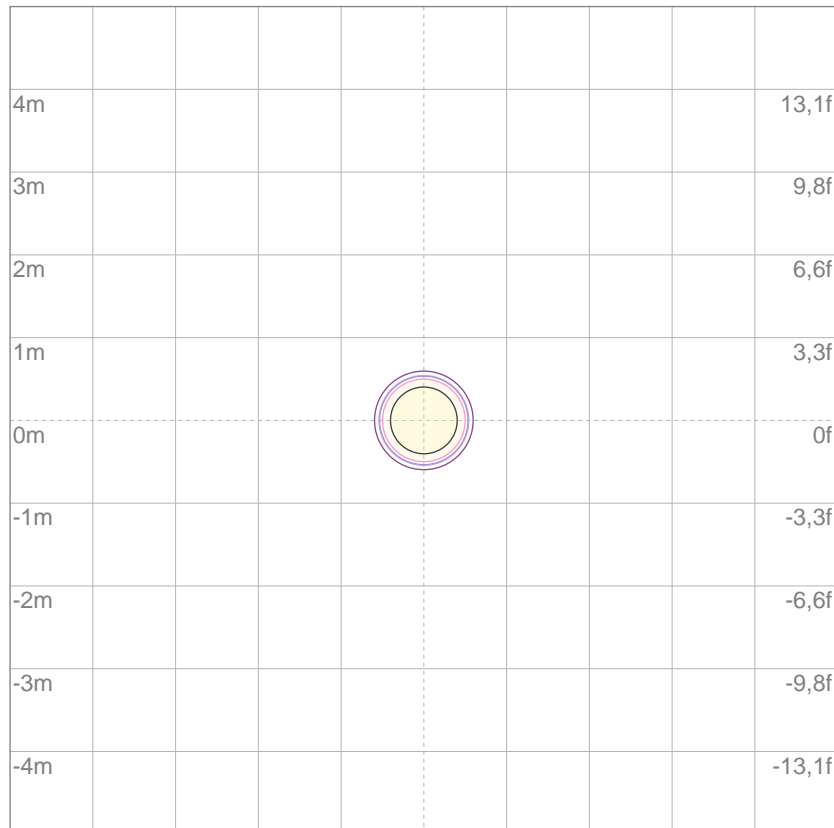

3%	43,9 lx
5%	73,2 lx
10%	146 lx
30%	439 lx
50%	732 lx

Conditions:

Number of c-planes: 2

Lux at center: 1464 lx

Lux distribution on a surface when lamp is mounted at 10 meters from the surface.

Mounting height: 10 meters (33 feet)



Total lumen output:

328 lm

Peak candela output:

891 cd

PRODUCT NAME:

ASTRAWASH7PIXIP

MEASUREMENT CONDITIONS:

Beam angle:

Max Zoom

Target:

Blue

Operator:

Paolo Carvone

Date and time:

15/02/2021 17:30:17

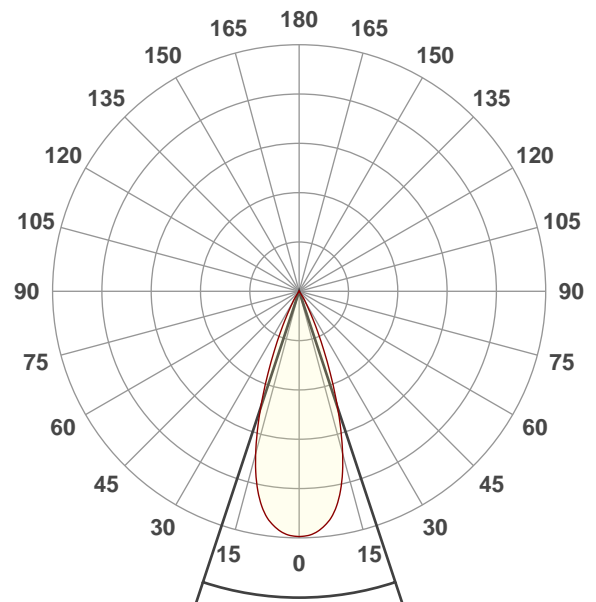

Beam angle 50%: 36,6°

Field angle 10%: 54,9°

Cut off angle 2.5%: 66,5°

Spectra

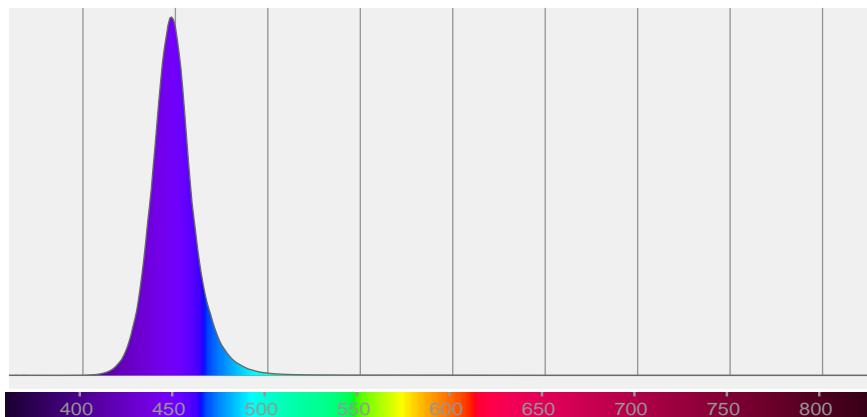

BEAM DETAILS



Beam angle 50%	Field angle 10%	Cut off angle 2,5%	Intensity ratio in 120° cone	Intensity ratio in 90° cone
36,6°	54,9°	66,5°	99,5%	99,3%

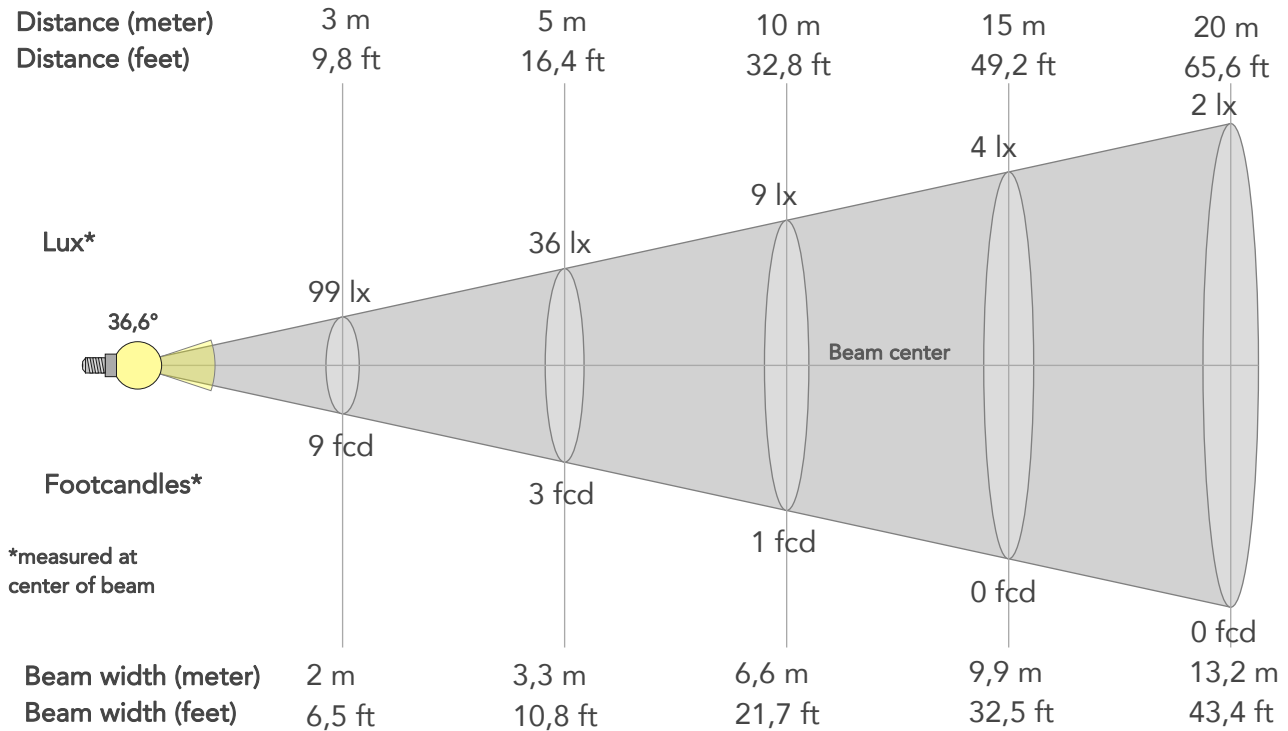

BEAM INTENSITIES AND WIDTHS

Distance	1m	2m	3m	4m	5m	7,5m	10m	15m	20m	25m	30m	40m	50m
Distance	3,3ft	6,6ft	9,8ft	13,1ft	16,4ft	24,6ft	32,8ft	49,2ft	65,6ft	82ft	98,4ft	131,2ft	164ft
Lux	891lx	223lx	99lx	56lx	36lx	16lx	9lx	4lx	2lx	1lx	1lx	1lx	0lx
Footcand.	83fcd	21fcd	9fcd	5fcd	3fcd	1fcd	1fcd	0fcd	0fcd	0fcd	0fcd	0fcd	0fcd
Beam wid.	0,7m	1,3m	2m	2,6m	3,3m	5m	6,6m	9,9m	13,2m	16,5m	19,8m	26,5m	33,1m
Beam wid.	2,2ft	4,4ft	6,5ft	8,7ft	10,8ft	16,3ft	21,7ft	32,5ft	43,4ft	54,2ft	65,1ft	86,8ft	108,5ft

LINEAR DISTRIBUTION DIAGRAM

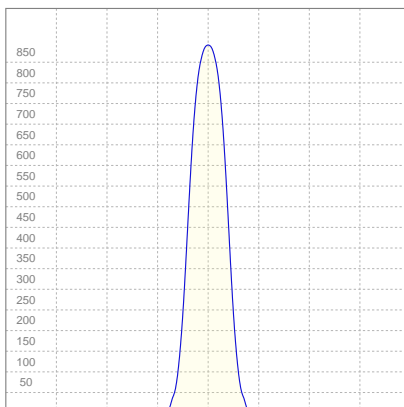

ELECTRICAL SPECIFICATIONS

Input voltage	Input current	Input power	Effeciency
222V	0,518A	94,5W	3lm/W

Power FC
0,82

ISO CANDELA DIAGRAM

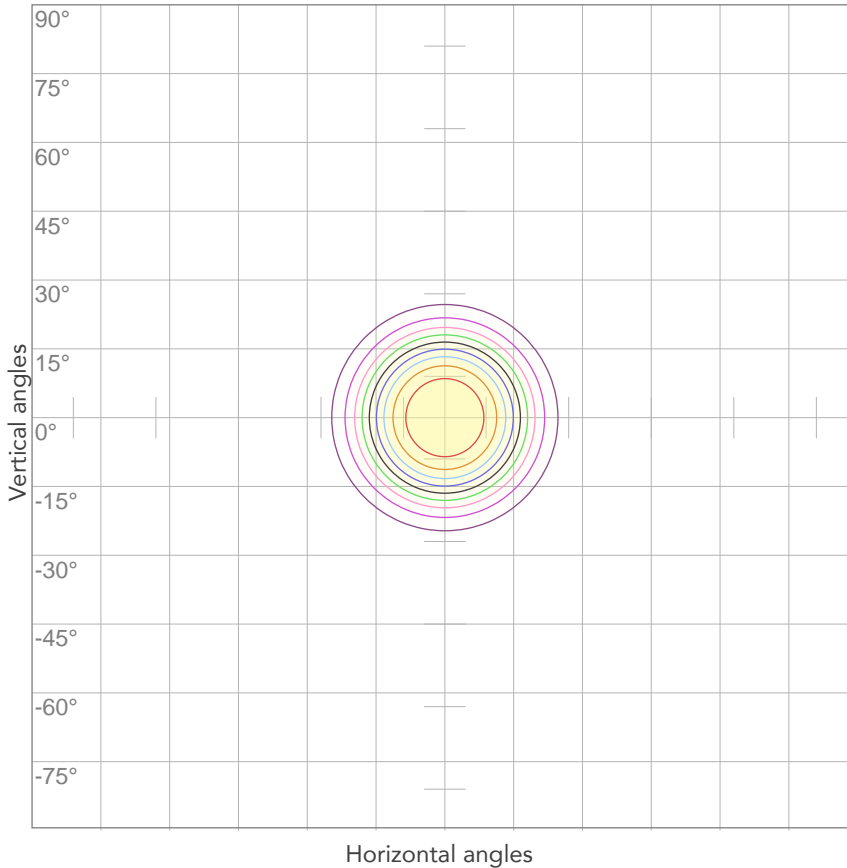

10%	89 cd
20%	178 cd
30%	267 cd
40%	356 cd
50%	446 cd
60%	535 cd
70%	624 cd
80%	713 cd

Conditions:

Number of c-planes: 2

Candela at center: 891 cd

ISO LUX DIAGRAM

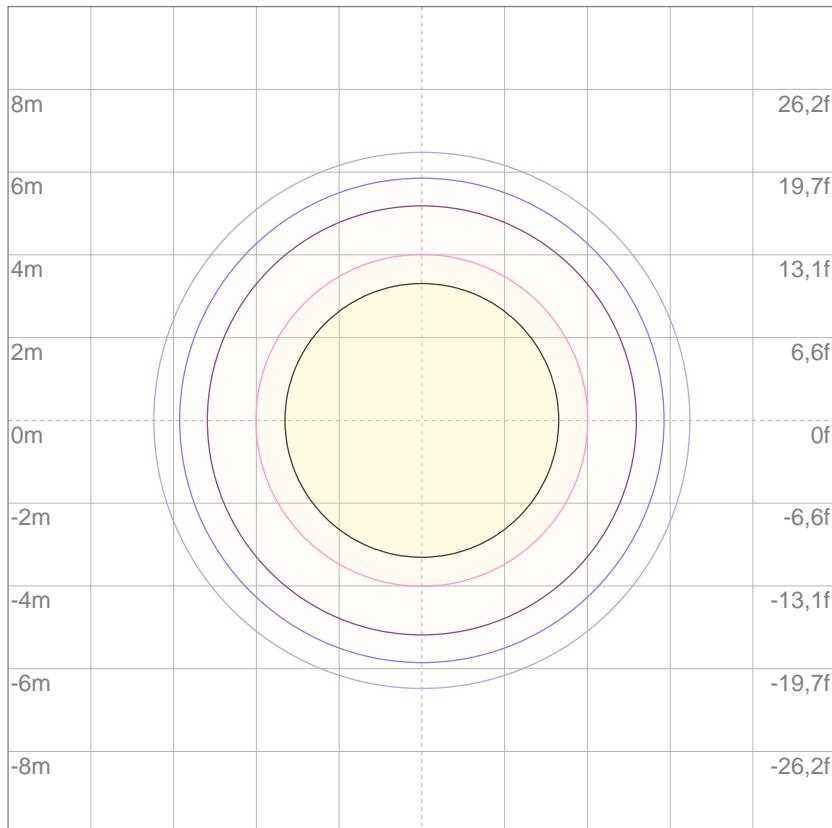

3%	0,267 lx
5%	0,446 lx
10%	0,891 lx
30%	2,67 lx
50%	4,46 lx

Conditions:

Number of c-planes: 2

Lux at center: 8,91 lx

Lux distribution on a surface when lamp is mounted at 10 meters from the surface.

Mounting height: 10 meters (33 feet)



Total lumen output:

290 lm

Peak candela output:

3449 cd

PRODUCT NAME:

ASTRAWASH7PIXIP

MEASUREMENT CONDITIONS:

Beam angle:

Med Zoom

Target:

Blue

Operator:

Paolo Carvone

Date and time:

15/02/2021 17:31:52

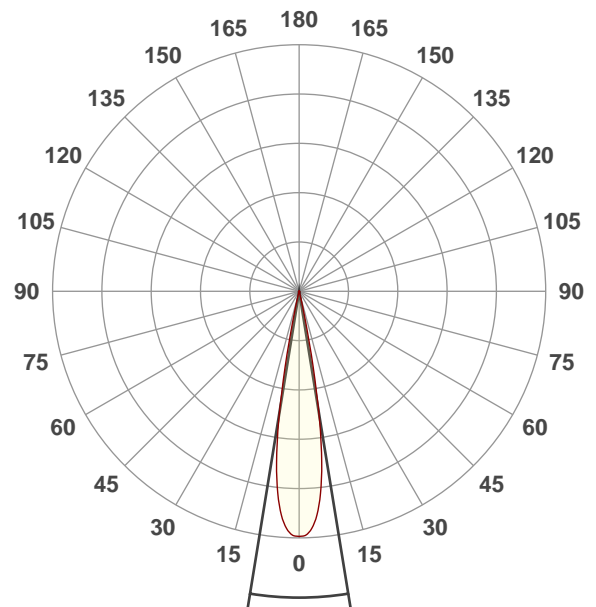

Beam angle 50%: 18,5°

Field angle 10%: 24,8°

Cut off angle 2.5%: 27°

Spectra

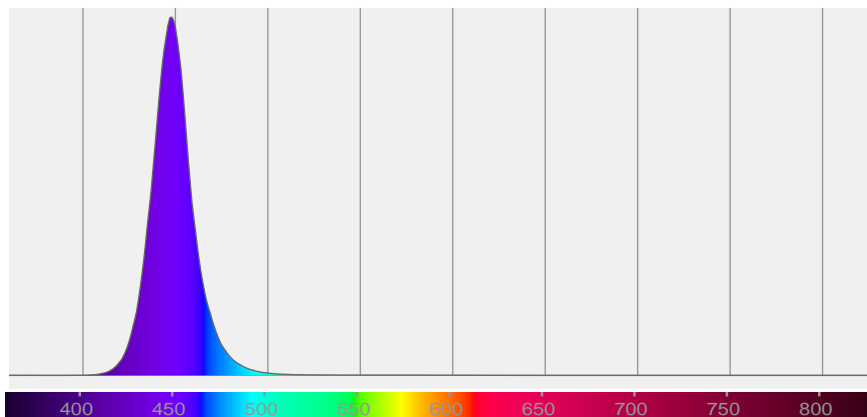

BEAM DETAILS



Beam angle 50%	Field angle 10%	Cut off angle 2,5%	Intensity ratio in 120° cone	Intensity ratio in 90° cone
18,5°	24,8°	27°	99,6%	99,3%

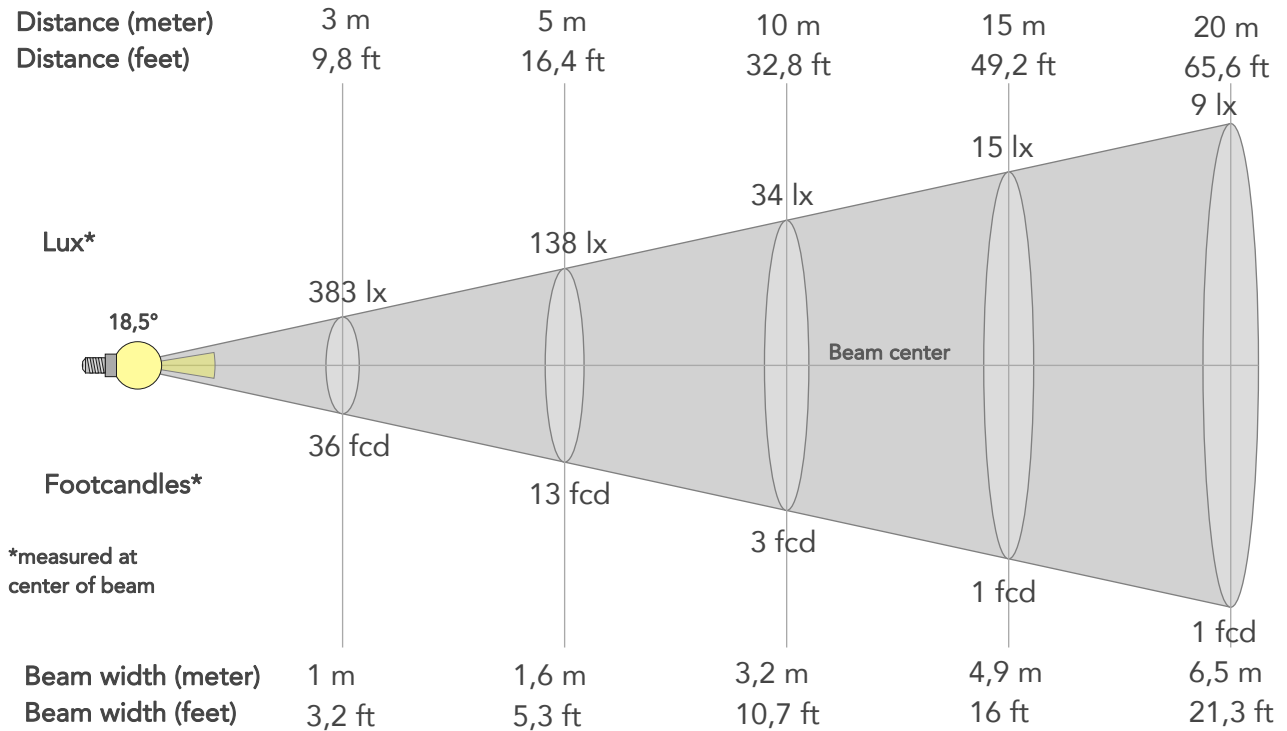

BEAM INTENSITIES AND WIDTHS

Distance	1m	2m	3m	4m	5m	7,5m	10m	15m	20m	25m	30m	40m	50m
Distance	3,3ft	6,6ft	9,8ft	13,1ft	16,4ft	24,6ft	32,8ft	49,2ft	65,6ft	82ft	98,4ft	131,2ft	164ft
Lux	3449lx	862lx	383lx	216lx	138lx	61lx	34lx	15lx	9lx	6lx	4lx	2lx	1lx
Footcand.	320fcd	80fcd	36fcd	20fcd	13fcd	6fcd	3fcd	1fcd	1fcd	1fcd	0fcd	0fcd	0fcd
Beam wid.	0,3m	0,6m	1m	1,3m	1,6m	2,4m	3,2m	4,9m	6,5m	8,1m	9,7m	13m	16,2m
Beam wid.	1,1ft	2,1ft	3,2ft	4,3ft	5,3ft	8ft	10,7ft	16ft	21,3ft	26,6ft	32ft	42,6ft	53,3ft

LINEAR DISTRIBUTION DIAGRAM

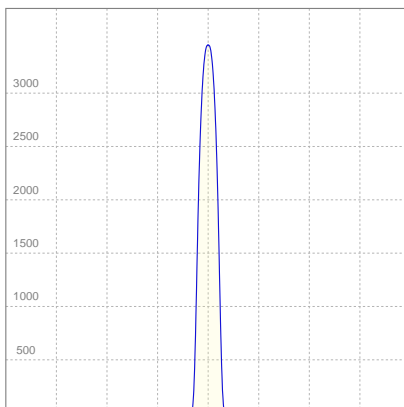

ELECTRICAL SPECIFICATIONS

Input voltage	Input current	Input power	Effeciency
221V	0,518A	94,4W	3lm/W

Power FC
0,82

ISO CANDELA DIAGRAM

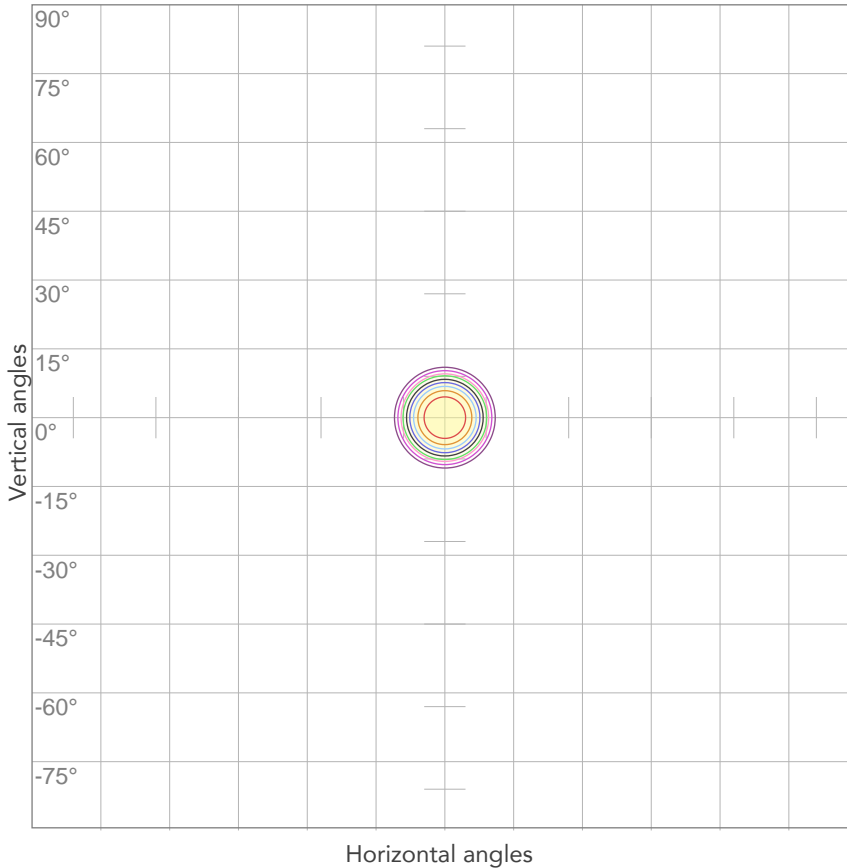

10%	345 cd
20%	690 cd
30%	1035 cd
40%	1380 cd
50%	1725 cd
60%	2070 cd
70%	2414 cd
80%	2759 cd

Conditions:

Number of c-planes: 2

Candela at center: 3449 cd

ISO LUX DIAGRAM

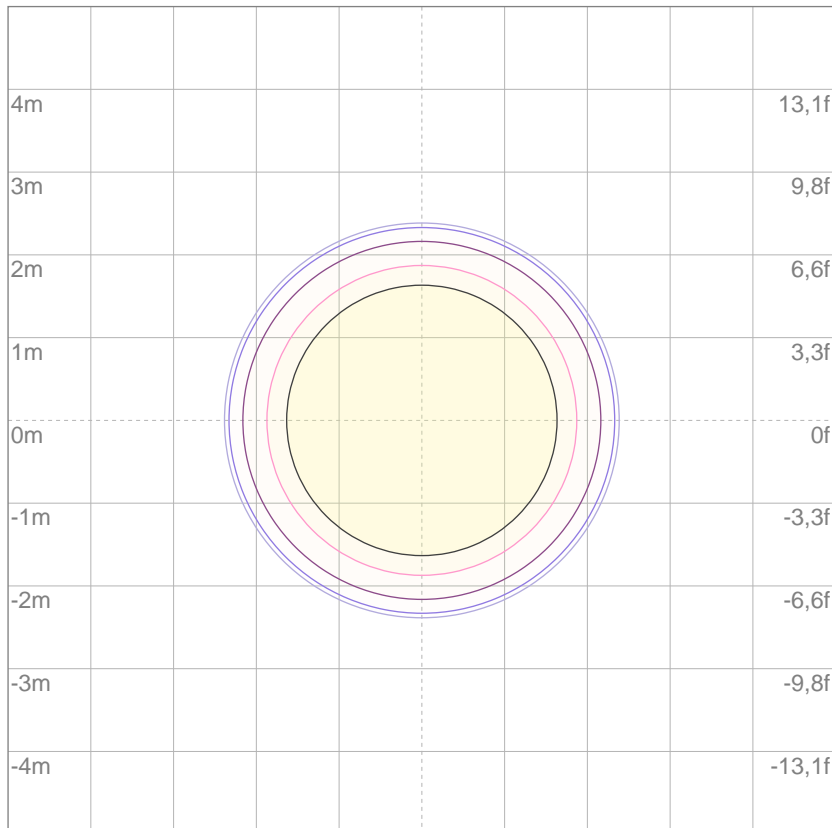

3%	1,03 lx
5%	1,72 lx
10%	3,45 lx
30%	10,3 lx
50%	17,2 lx

Conditions:

Number of c-planes: 2

Lux at center: 34,5 lx

Lux distribution on a surface when lamp is mounted at 10 meters from the surface.

Mounting height: 10 meters (33 feet)



Total lumen output:

189 lm

Peak candela output:

41756 cd

PRODUCT NAME:

ASTRAWASH7PIXIP

MEASUREMENT CONDITIONS:

Beam angle:

Min Zoom

Target:

Blue

Operator:

Paolo Carvone

Date and time:

15/02/2021 17:33:52

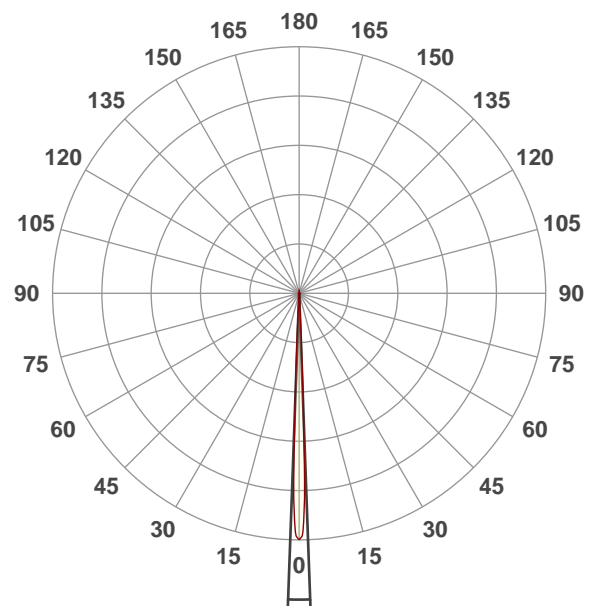

Beam angle 50%: 4,1°

Field angle 10%: 5,8°

Cut off angle 2.5%: 6,9°

Spectra

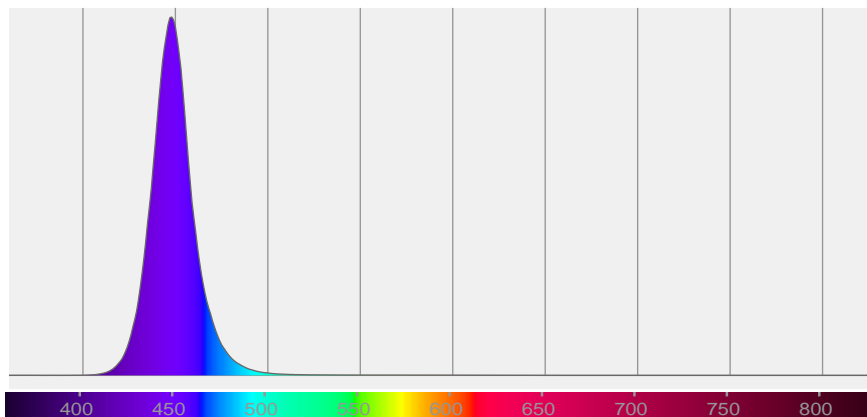

BEAM DETAILS



Beam angle 50%	Field angle 10%	Cut off angle 2,5%	Intensity ratio in 120° cone	Intensity ratio in 90° cone
4,1°	5,8°	6,9°	99,8%	99,7%

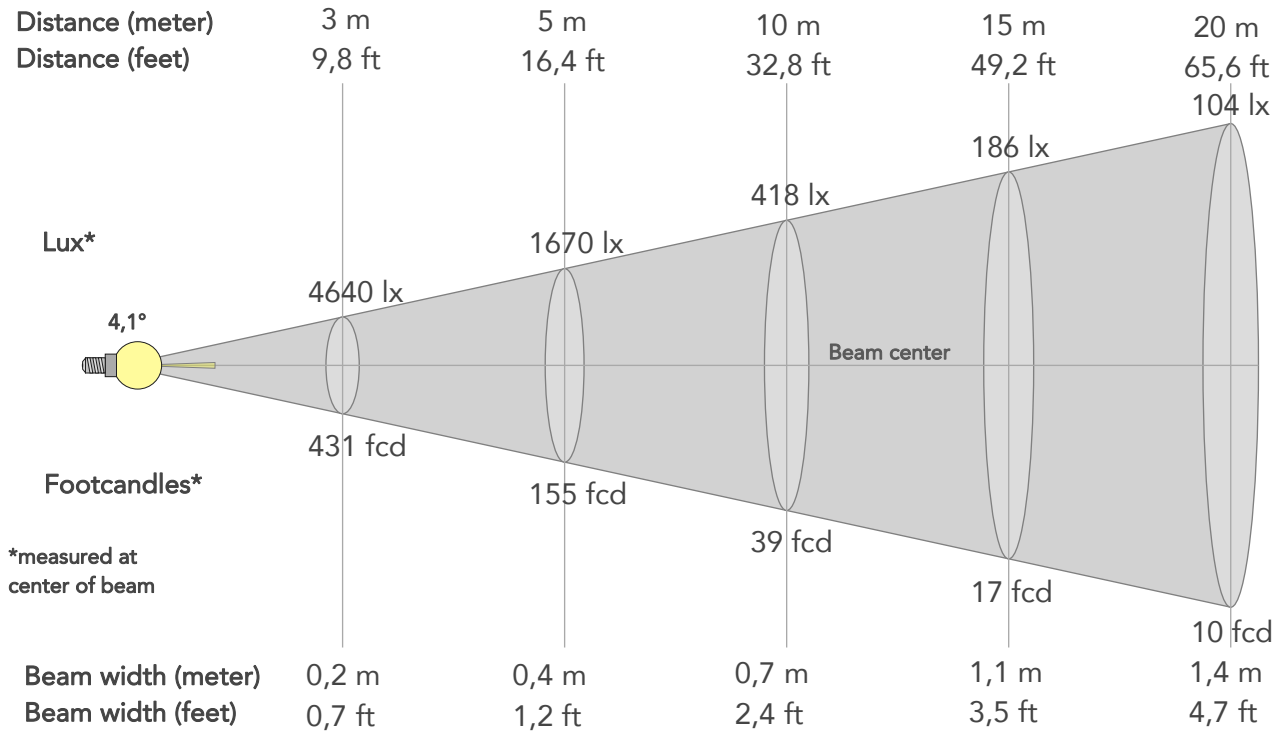

BEAM INTENSITIES AND WIDTHS

Distance	1m	2m	3m	4m	5m	7,5m	10m	15m	20m	25m	30m	40m	50m
Distance	3,3ft	6,6ft	9,8ft	13,1ft	16,4ft	24,6ft	32,8ft	49,2ft	65,6ft	82ft	98,4ft	131,2ft	164ft
Lux	41756lx	10439lx	4640lx	2610lx	1670lx	742lx	418lx	186lx	104lx	67lx	46lx	26lx	17lx
Footcand.	3879fcd	970fcd	431fcd	242fcd	155fcd	69fcd	39fcd	17fcd	10fcd	6fcd	4fcd	2fcd	2fcd
Beam wid.	0,1m	0,1m	0,2m	0,3m	0,4m	0,5m	0,7m	1,1m	1,4m	1,8m	2,2m	2,9m	3,6m
Beam wid.	0,2ft	0,5ft	0,7ft	0,9ft	1,2ft	1,8ft	2,4ft	3,5ft	4,7ft	5,9ft	7,1ft	9,5ft	11,8ft

LINEAR DISTRIBUTION DIAGRAM

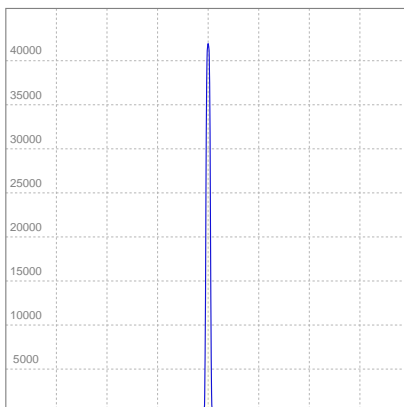

ELECTRICAL SPECIFICATIONS

Input voltage	Input current	Input power	Effeciency
222V	0,513A	93,4W	2lm/W

Power FC
0,82

ISO CANDELA DIAGRAM

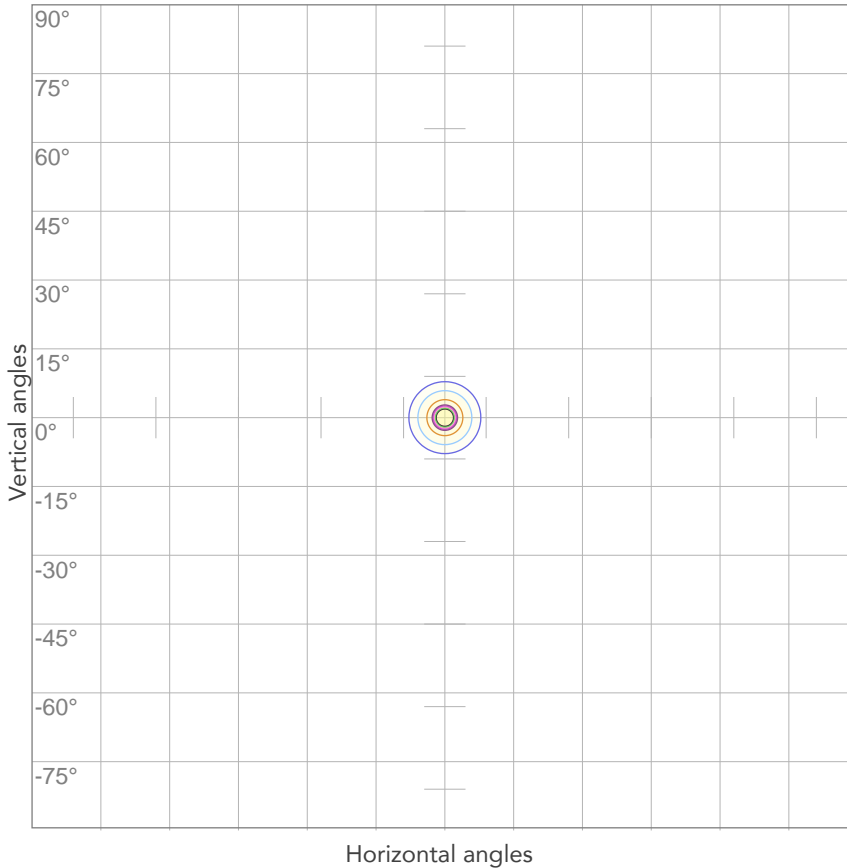

10%	4176 cd
20%	8351 cd
30%	12527 cd
40%	16702 cd
50%	20878 cd
60%	25054 cd
70%	29229 cd
80%	33405 cd

Conditions:

Number of c-planes: 2

Candela at center: 41756 cd

ISO LUX DIAGRAM

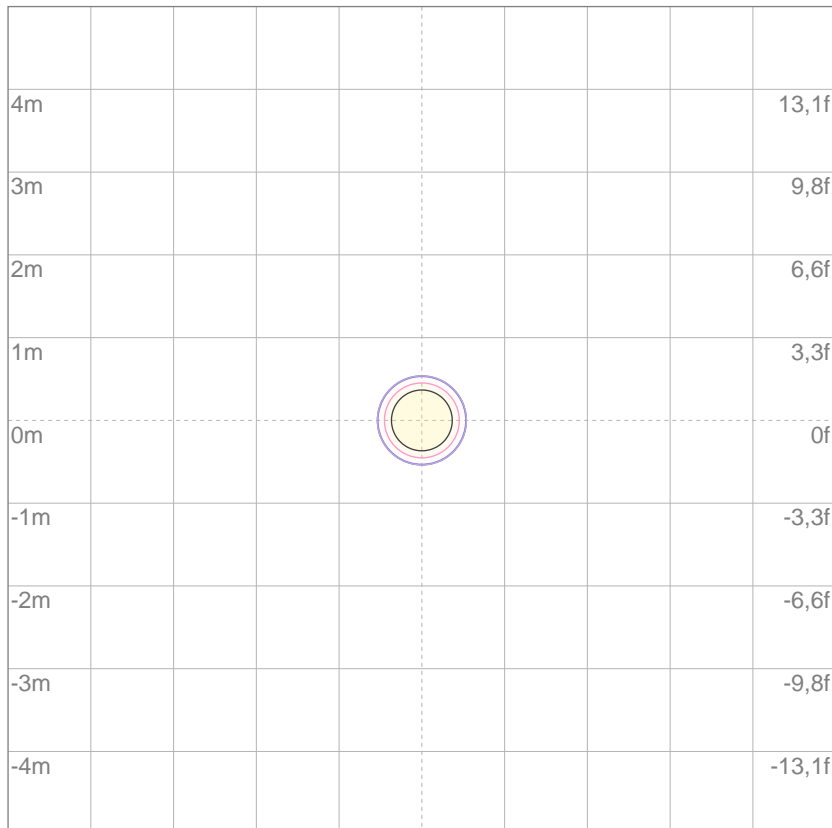

Mounting height: 10 meters (33 feet)

3%	12,5 lx
5%	20,9 lx
10%	41,8 lx
30%	125 lx
50%	209 lx

Conditions:

Number of c-planes: 2

Lux at center: 418 lx

Lux distribution on a surface when lamp is mounted at 10 meters from the surface.



Total lumen output:

1905 lm

Peak candela output:

4654 cd

PRODUCT NAME:

ASTRAWASH7PIXIP

MEASUREMENT CONDITIONS:

Beam angle:

Max Zoom

Target:

White

Operator:

Paolo Carvone

Date and time:

15/02/2021 17:40:29

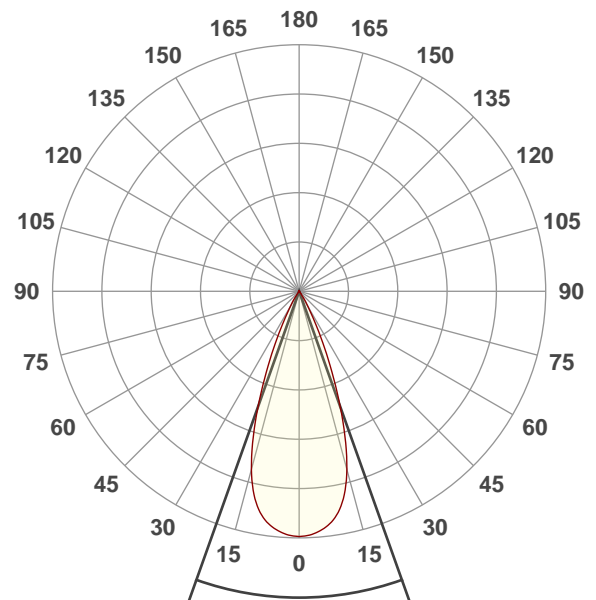

Beam angle 50%: 39,2°

Field angle 10%: 57,1°

Cut off angle 2.5%: 68,1°

Spectra

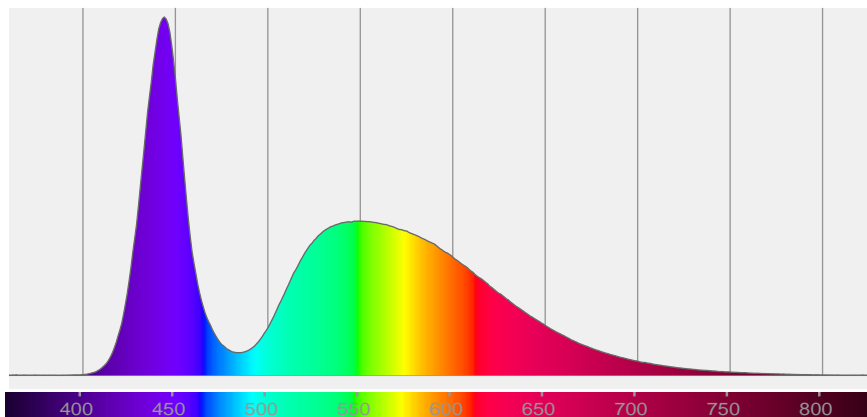

BEAM DETAILS



Beam angle 50%	Field angle 10%	Cut off angle 2,5%	Intensity ratio in 120° cone	Intensity ratio in 90° cone
39,2°	57,1°	68,1°	100,0%	100,0%

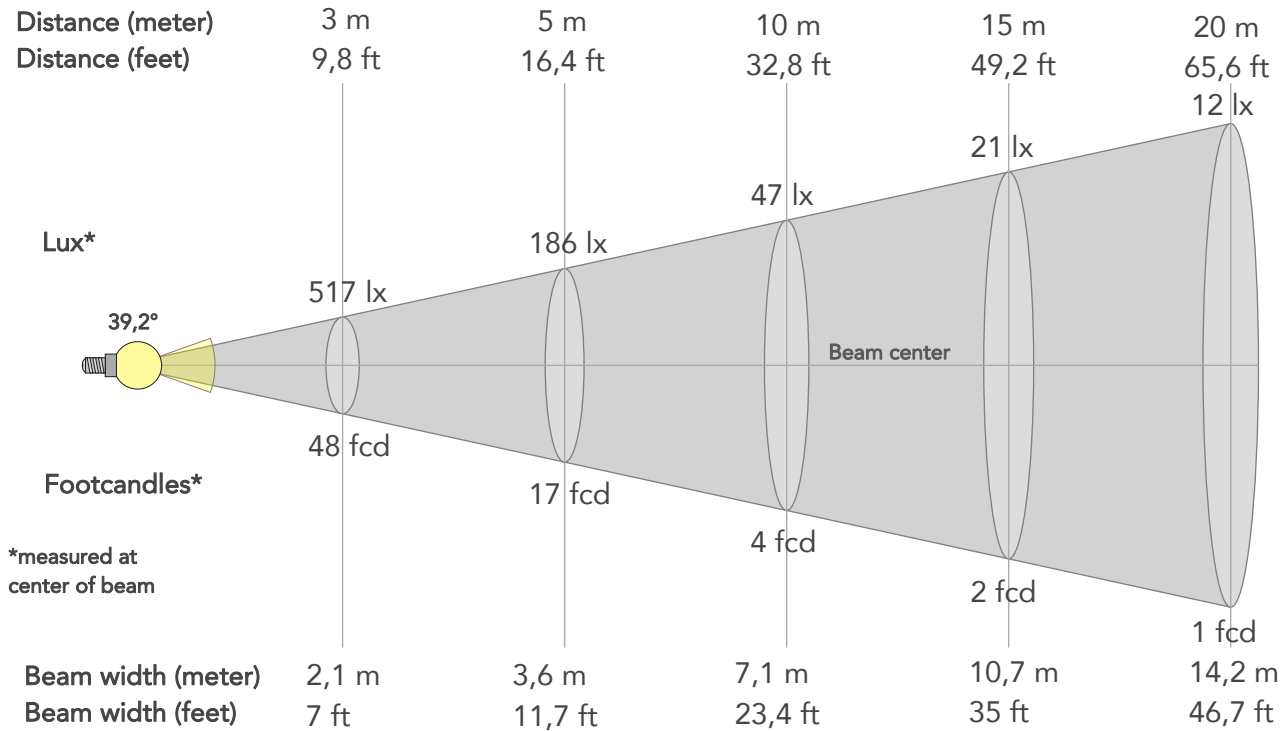

BEAM INTENSITIES AND WIDTHS

Distance	1m	2m	3m	4m	5m	7,5m	10m	15m	20m	25m	30m	40m	50m
Distance	3,3ft	6,6ft	9,8ft	13,1ft	16,4ft	24,6ft	32,8ft	49,2ft	65,6ft	82ft	98,4ft	131,2ft	164ft
Lux	4654lx	1164lx	517lx	291lx	186lx	83lx	47lx	21lx	12lx	7lx	5lx	3lx	2lx
Footcand.	432fcd	108fcd	48fcd	27fcd	17fcd	8fcd	4fcd	2fcd	1fcd	1fcd	0fcd	0fcd	0fcd
Beam wid.	0,7m	1,4m	2,1m	2,8m	3,6m	5,3m	7,1m	10,7m	14,2m	17,8m	21,4m	28,5m	35,6m
Beam wid.	2,4ft	4,7ft	7ft	9,3ft	11,7ft	17,5ft	23,4ft	35ft	46,7ft	58,4ft	70,1ft	93,4ft	116,8ft

LINEAR DISTRIBUTION DIAGRAM

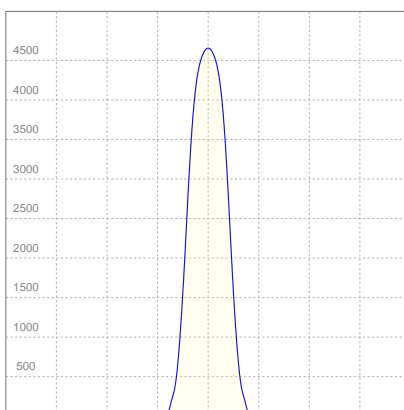

ELECTRICAL SPECIFICATIONS

Input voltage	Input current	Input power	Efficiency
221V	0,518A	94,3W	20lm/W

Power FC
0,82

ISO CANDELA DIAGRAM

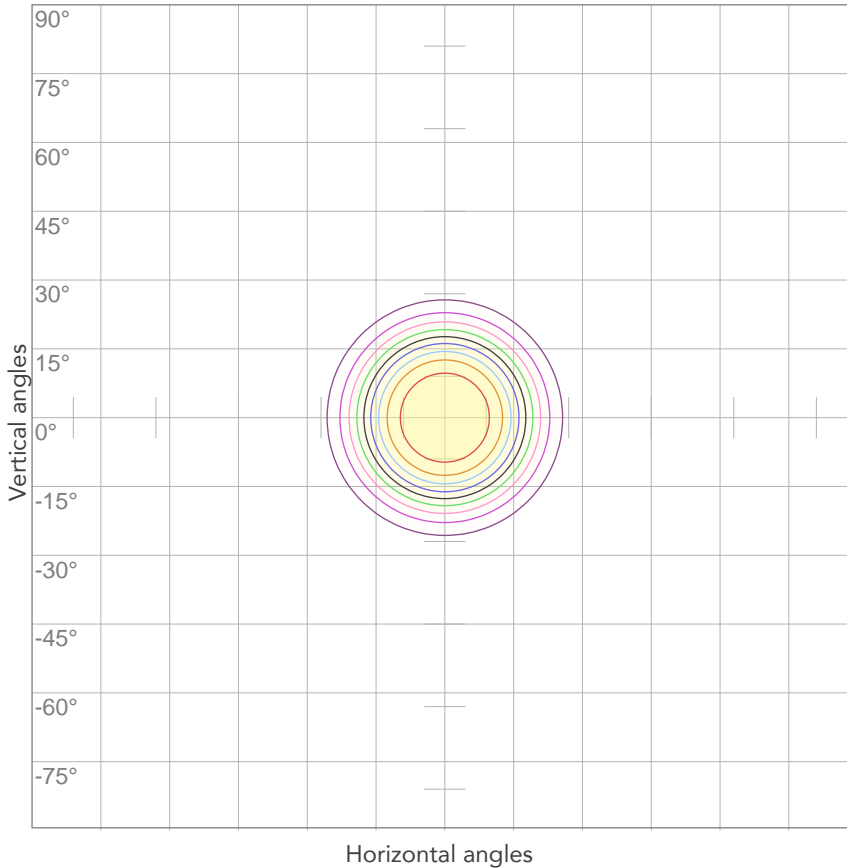

10%	465 cd
20%	931 cd
30%	1396 cd
40%	1862 cd
50%	2327 cd
60%	2793 cd
70%	3258 cd
80%	3723 cd

Conditions:

Number of c-planes: 2

Candela at center: 4654 cd

ISO LUX DIAGRAM

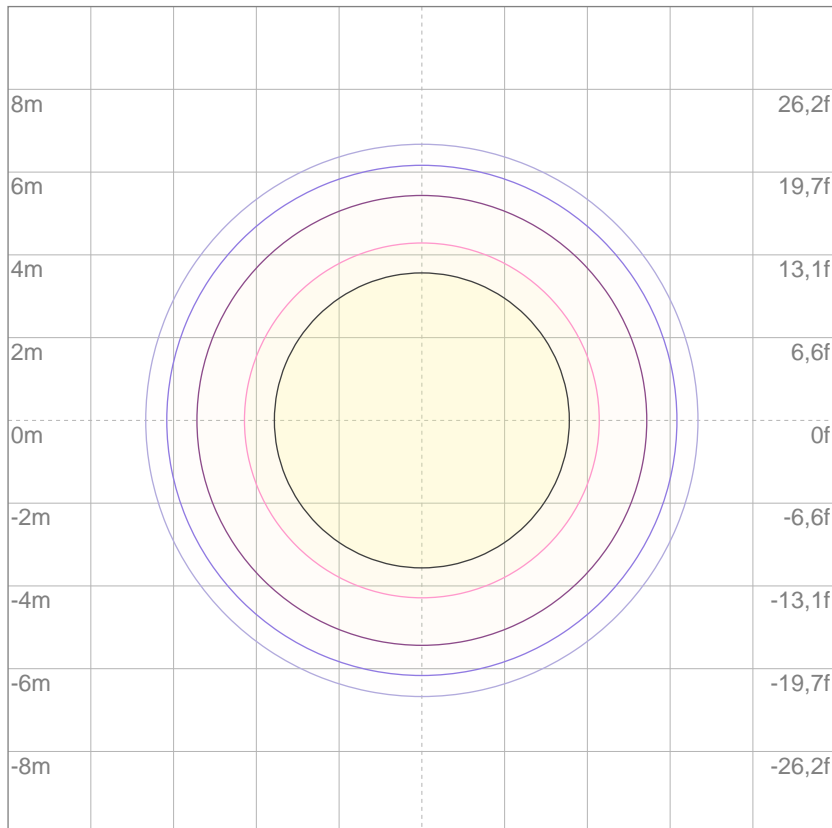

3%	1,40 lx
5%	2,33 lx
10%	4,65 lx
30%	14,0 lx
50%	23,3 lx

Conditions:

Number of c-planes: 2

Lux at center: 46,5 lx

Lux distribution on a surface when lamp is mounted at 10 meters from the surface.

Mounting height: 10 meters (33 feet)



Total lumen output:

1679 lm

Peak candela output:

17602 cd

PRODUCT NAME:

ASTRAWASH7PIXIP

MEASUREMENT CONDITIONS:

Beam angle:

Med Zoom

Target:

White

Operator:

Paolo Carvone

Date and time:

16/02/2021 09:31:55

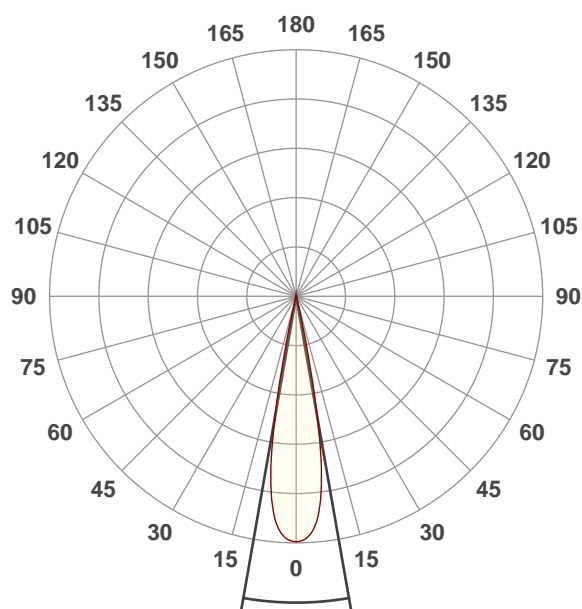

Spectra

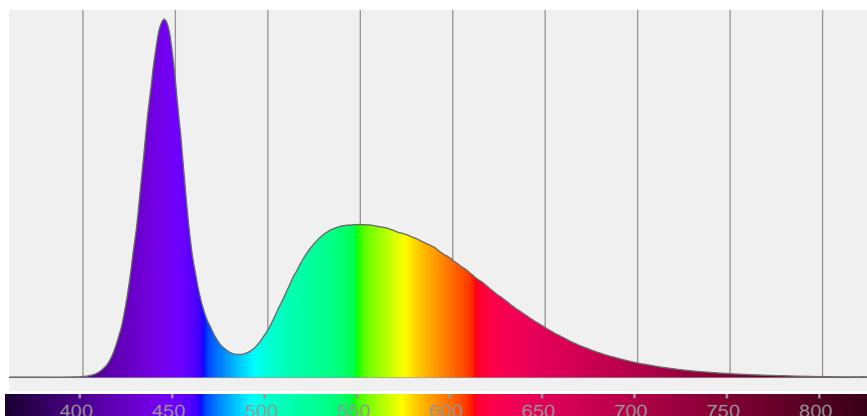

BEAM DETAILS



Beam angle 50%	Field angle 10%	Cut off angle 2,5%	Intensity ratio in 120° cone	Intensity ratio in 90° cone
19,9°	26°	28,7°	100,0%	100,0%

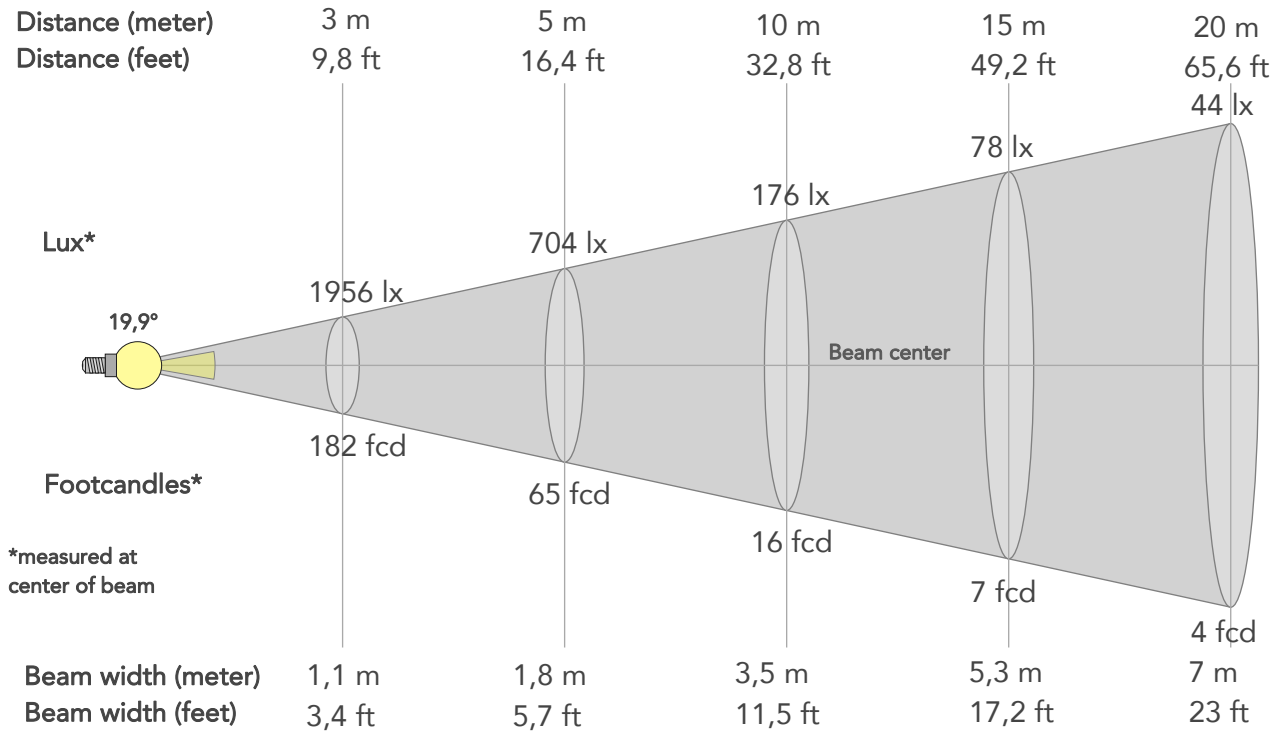

BEAM INTENSITIES AND WIDTHS

Distance	1m	2m	3m	4m	5m	7,5m	10m	15m	20m	25m	30m	40m	50m
Distance	3,3ft	6,6ft	9,8ft	13,1ft	16,4ft	24,6ft	32,8ft	49,2ft	65,6ft	82ft	98,4ft	131,2ft	164ft
Lux	17602lx	4400lx	1956lx	1100lx	704lx	313lx	176lx	78lx	44lx	28lx	20lx	11lx	7lx
Footcand.	1635fcd	409fcd	182fcd	102fcd	65fcd	29fcd	16fcd	7fcd	4fcd	3fcd	2fcd	1fcd	1fcd
Beam wid.	0,4m	0,7m	1,1m	1,4m	1,8m	2,6m	3,5m	5,3m	7m	8,8m	10,5m	14m	17,5m
Beam wid.	1,2ft	2,3ft	3,4ft	4,6ft	5,7ft	8,6ft	11,5ft	17,2ft	23ft	28,7ft	34,4ft	45,9ft	57,4ft

LINEAR DISTRIBUTION DIAGRAM

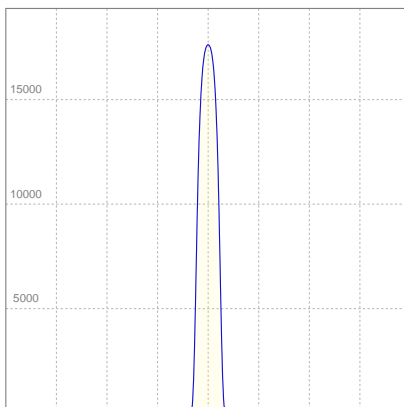

ELECTRICAL SPECIFICATIONS

Input voltage	Input current	Input power	Efficiency
223V	0,534A	97,6W	17lm/W

Power FC
0,82

ISO CANDELA DIAGRAM

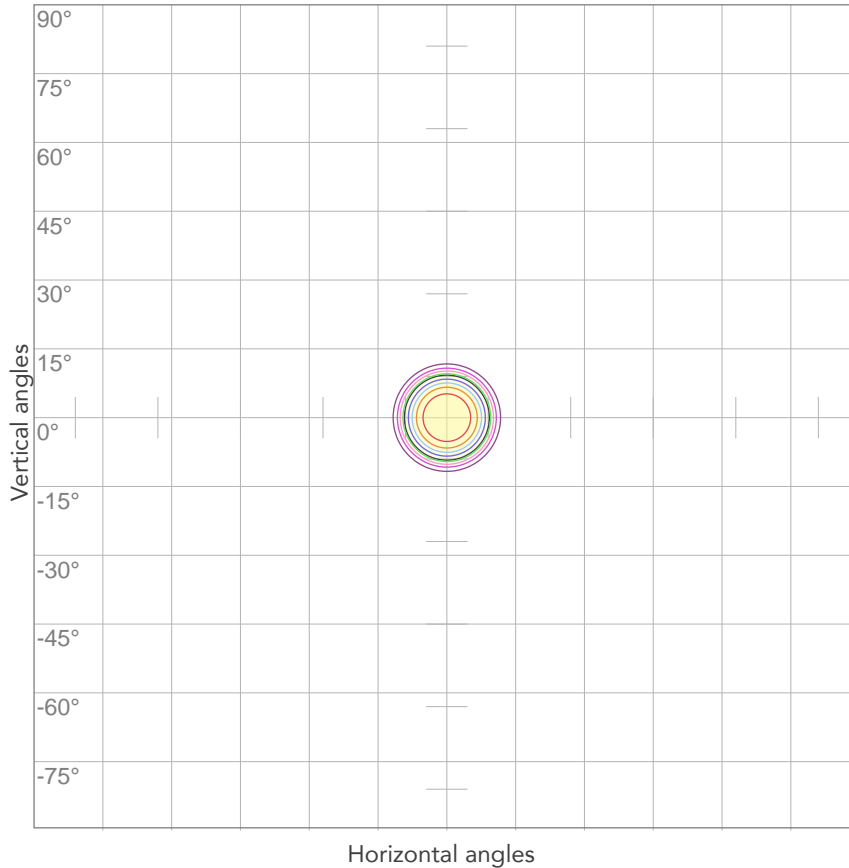

10%	1760 cd
20%	3520 cd
30%	5281 cd
40%	7041 cd
50%	8801 cd
60%	10561 cd
70%	12321 cd
80%	14081 cd

Conditions:

Number of c-planes: 2

Candela at center: 17602 cd

ISO LUX DIAGRAM

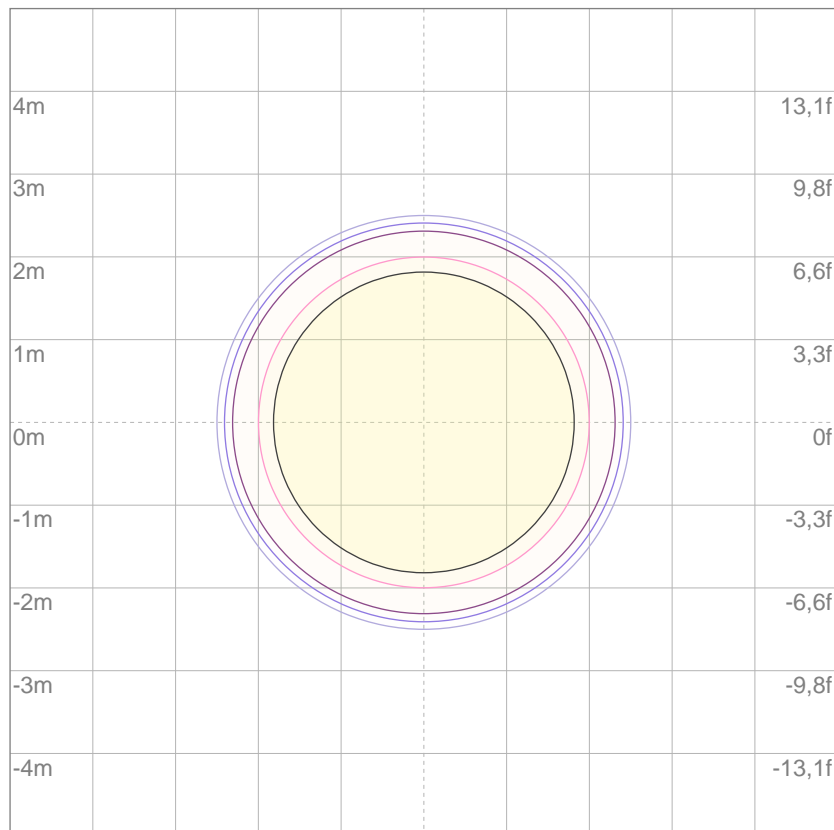

3%	5,28 lx
5%	8,80 lx
10%	17,6 lx
30%	52,8 lx
50%	88,0 lx

Conditions:

Number of c-planes: 2

Lux at center: 176 lx

Lux distribution on a surface when lamp is mounted at 10 meters from the surface.

Mounting height: 10 meters (33 feet)



Total lumen output:

1072 lm

Peak candela output:

239823 cd

PRODUCT NAME:
ASTRAWASH7PIXIP

MEASUREMENT CONDITIONS:

Beam angle:
Min Zoom

Target:
White

Operator:
Paolo Carvone

Date and time:
16/02/2021 09:30:33

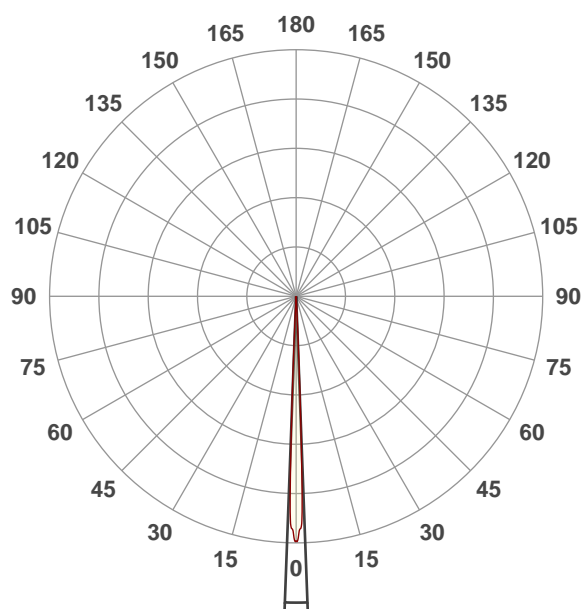

Beam angle 50%: 4,2°
Field angle 10%: 5,5°
Cut off angle 2.5%: 6,1°

Spectra

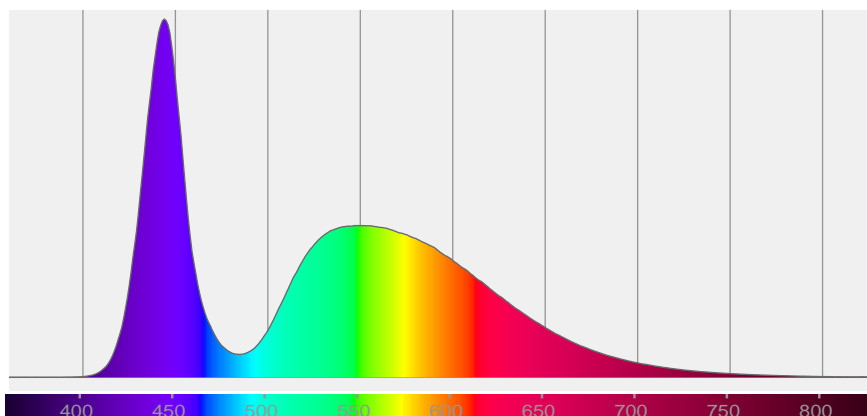

BEAM DETAILS



Beam angle 50%	Field angle 10%	Cut off angle 2,5%	Intensity ratio in 120° cone	Intensity ratio in 90° cone
4,2°	5,5°	6,1°	100,0%	100,0%

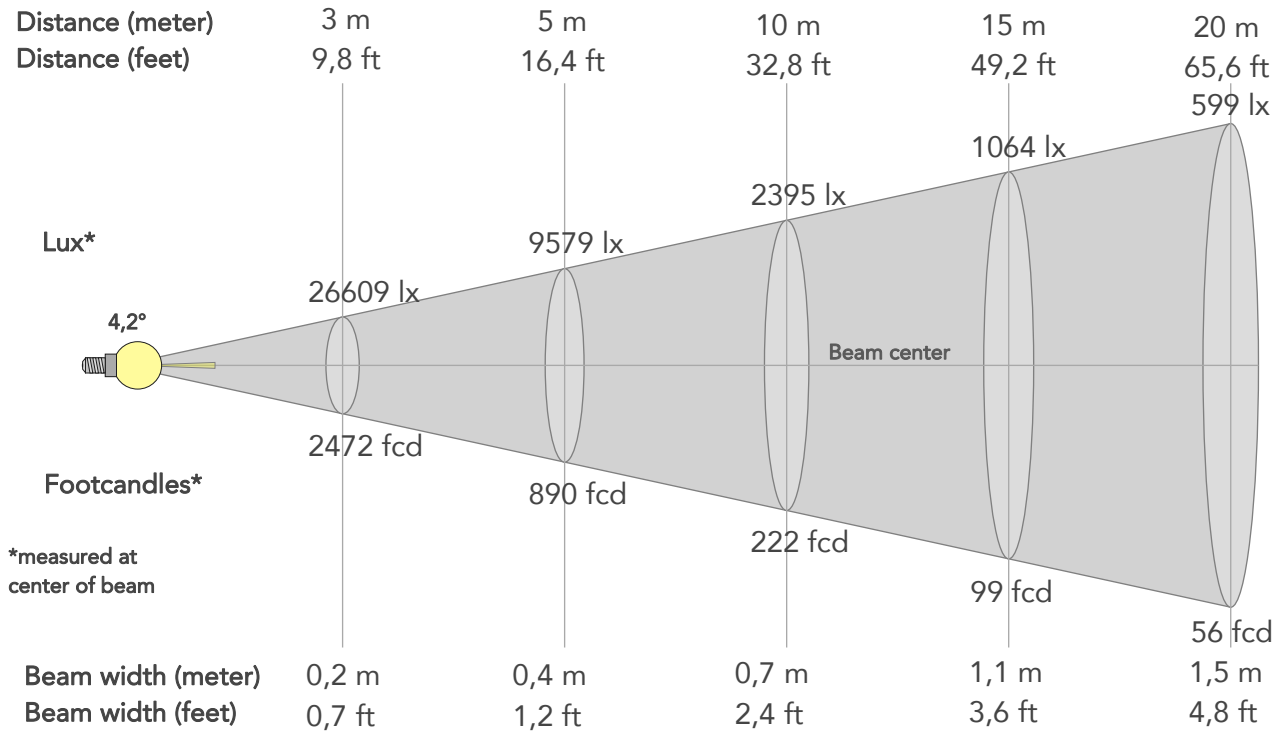

BEAM INTENSITIES AND WIDTHS

Distance	1m	2m	3m	4m	5m	7,5m	10m	15m	20m	25m	30m	40m	50m
Distance	3,3ft	6,6ft	9,8ft	13,1ft	16,4ft	24,6ft	32,8ft	49,2ft	65,6ft	82ft	98,4ft	131,2ft	164ft
Lux	239482lx	59871lx	26609lx	14968lx	9579lx	4257lx	2395lx	1064lx	599lx	383lx	266lx	150lx	96lx
Footcand.	22249fcd	5562fcd	2472fcd	1391fcd	890fcd	396fcd	222fcd	99fcd	56fcd	36fcd	25fcd	14fcd	9fcd
Beam wid.	0,1m	0,1m	0,2m	0,3m	0,4m	0,6m	0,7m	1,1m	1,5m	1,8m	2,2m	3m	3,7m
Beam wid.	0,2ft	0,5ft	0,7ft	1ft	1,2ft	1,8ft	2,4ft	3,6ft	4,8ft	6,1ft	7,3ft	9,7ft	12,1ft

LINEAR DISTRIBUTION DIAGRAM

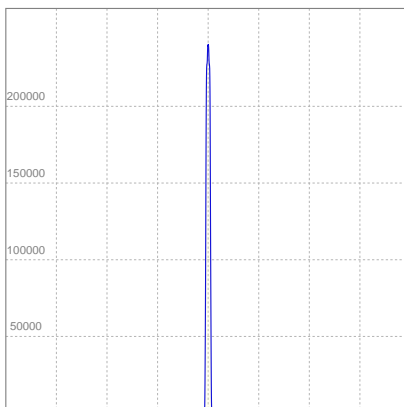

ELECTRICAL SPECIFICATIONS

Input voltage	Input current	Input power	Effeciency
223V	0,536A	97,9W	11lm/W

Power FC
0,82

ISO CANDELA DIAGRAM

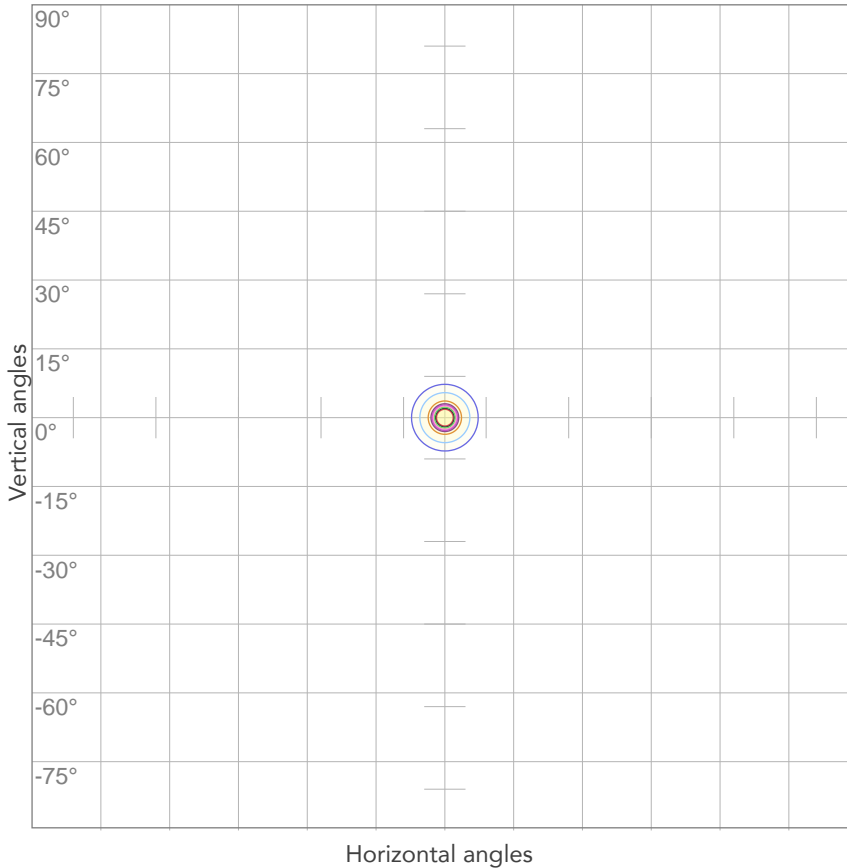

10%	23948 cd
20%	47896 cd
30%	71845 cd
40%	95793 cd
50%	119741 cd
60%	143689 cd
70%	167638 cd
80%	191586 cd

Conditions:

Number of c-planes: 2

Candela at center: 239482 cd

ISO LUX DIAGRAM

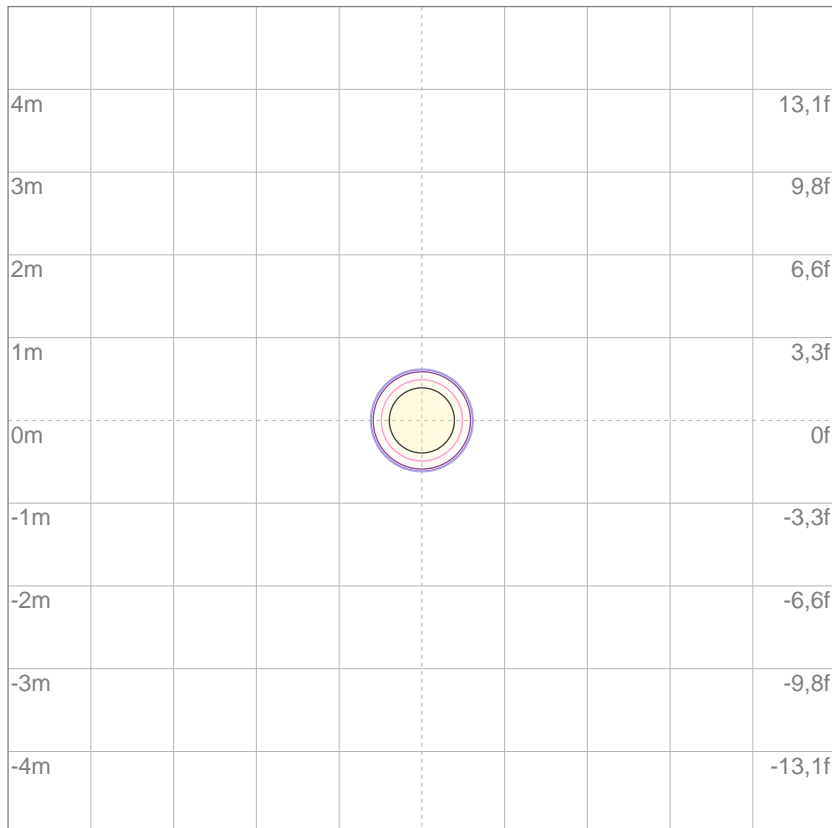

3%	71,8 lx
5%	120 lx
10%	239 lx
30%	718 lx
50%	1197 lx

Conditions:

Number of c-planes: 2

Lux at center: 2395 lx

Lux distribution on a surface when lamp is mounted at 10 meters from the surface.

Mounting height: 10 meters (33 feet)



Total lumen output:

2006 lm

Peak candela output:

5204 cd

Light quality:

CRI: 39,6

Color temperature:

2876 K

PRODUCT NAME:

ASTRAWASH7PIXIP

MEASUREMENT CONDITIONS:

Beam angle:

Max Zoom

Target:

2800K

Operator:

Paolo Carvone

Date and time:

16/02/2021 09:47:10

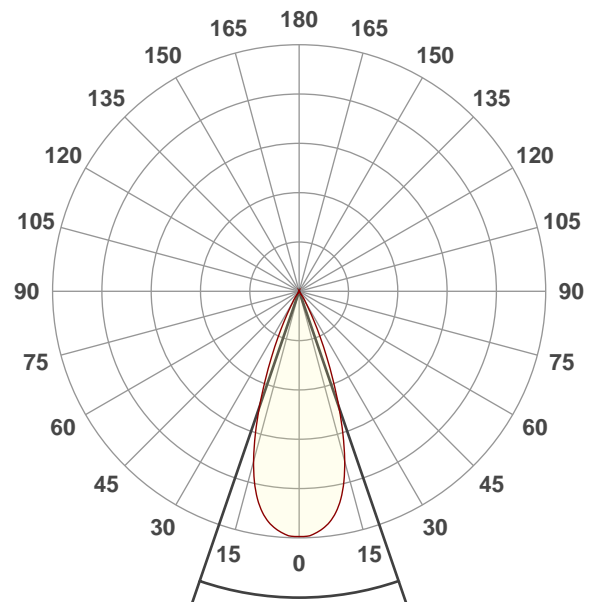

Beam angle 50%: 37,9°

Field angle 10%: 55,8°

Cut off angle 2.5%: 66,9°

Spectra

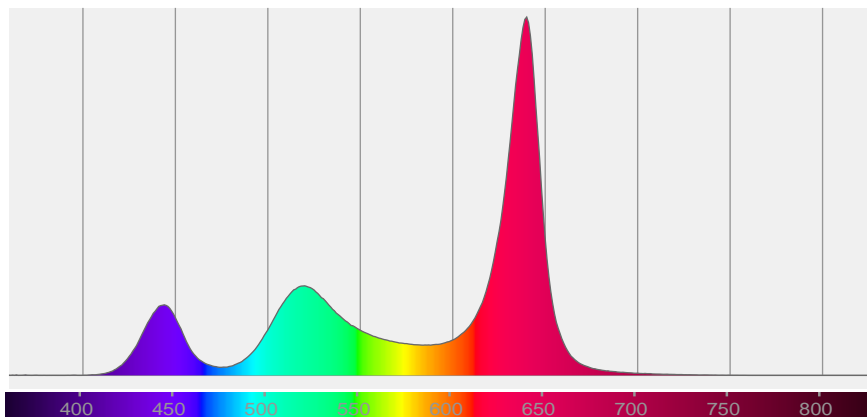

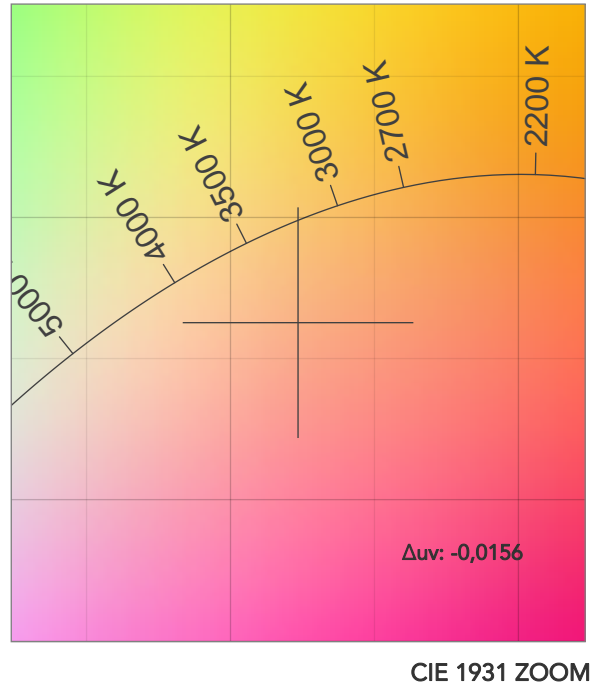
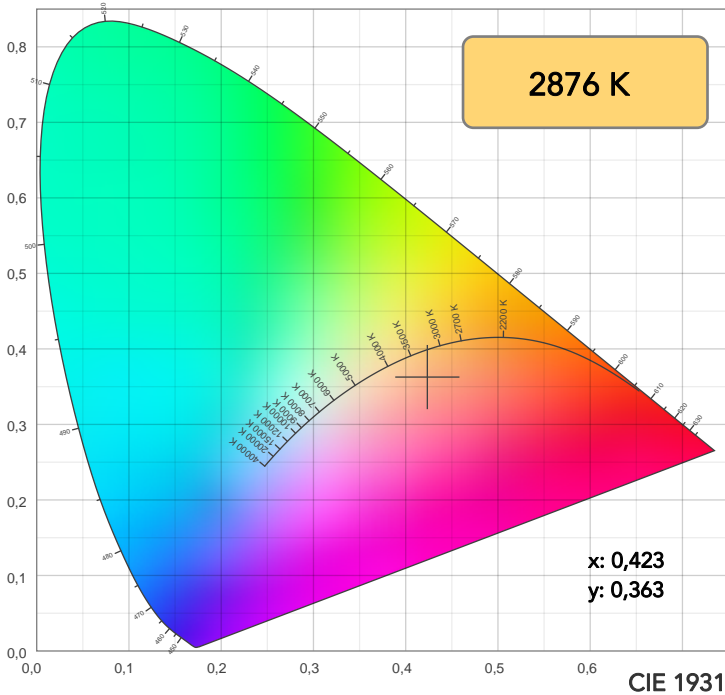

TM30: 62,8

CRI: 39,6 (R1-R8)

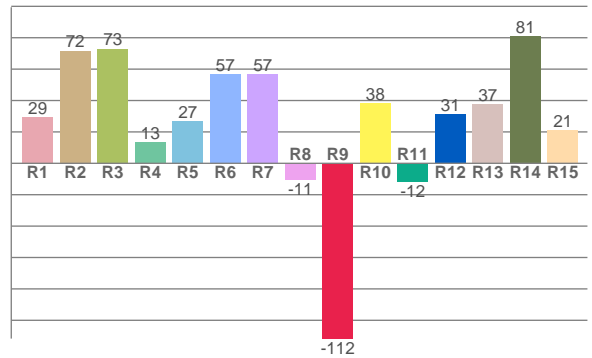
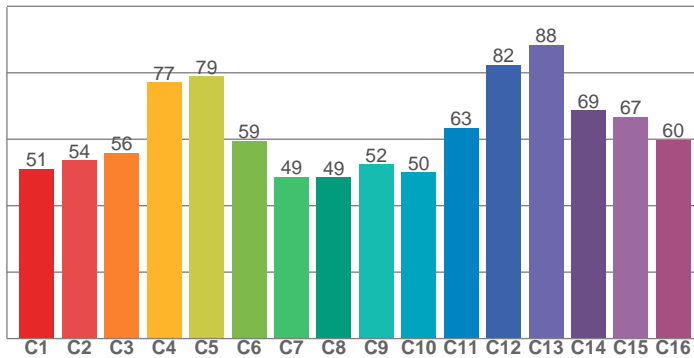

CRI R values, only R1-R8 are used to calculate final CRI value

R1	R2	R3	R4	R5	R6	R7	R8	R9	R10	R11	R12	R13	R14	R15
29,5	71,7	73,0	13,2	26,9	56,5	56,8	-10,6	-111,7	38,3	-12,1	31,1	37,5	81,1	21,1

TM30 C values, 16 binned values out of total of 99 C values

C1	C2	C3	C4	C5	C6	C7	C8	C9	C10	C11	C12	C13	C14	C15	C16
51,0	53,7	55,9	77,1	79,0	59,4	48,7	48,6	52,5	50,0	63,4	82,4	88,3	68,7	66,7	59,8

CQS Q values

Q1	Q2	Q3	Q4	Q5	Q6	Q7	Q8	Q9	Q10	Q11	Q12	Q13	Q14	Q15
78,0	92,9	79,8	48,6	44,0	50,9	87,9	75,9	84,6	87,4	64,8	57,6	61,0	79,4	81,8

CQS: 67,5

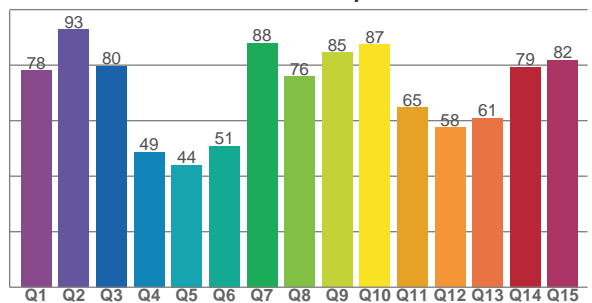

COLOR PARAMETERS

Color temperature	Color rendering index	Red component	Color fidelity	Color gamut	Color quality scale	Television lighting index	Color coordinate cie 1931	Color coordinate cie 1931	Color deviation from black body
CCT	CRI	CRI R9	TM30 Rf	TM30 Rg	CQS	TLCI	x	y	Δuv
2876 K	39,6	-111,7	62,8	129,8	67,5	24	0,423	0,363	-0,0156

TM30 DETAILS

Rf 62,8
Fidelity index Rf

Rg 129,8
Gammut index

Hue Bin	R _f	Graphic shifts (%)	
		Chroma	Hue
1	51	25%	-5%
2	54	20%	-15%
3	56	13%	-17%
4	77	9%	-6%
5	79	13%	7%
6	59	24%	15%
7	49	33%	5%
8	49	30%	-14%
9	52	21%	-22%
10	50	8%	-32%
11	63	0%	-27%
12	82	-2%	-9%
13	88	3%	6%
14	69	2%	24%
15	67	16%	12%
16	60	27%	12%

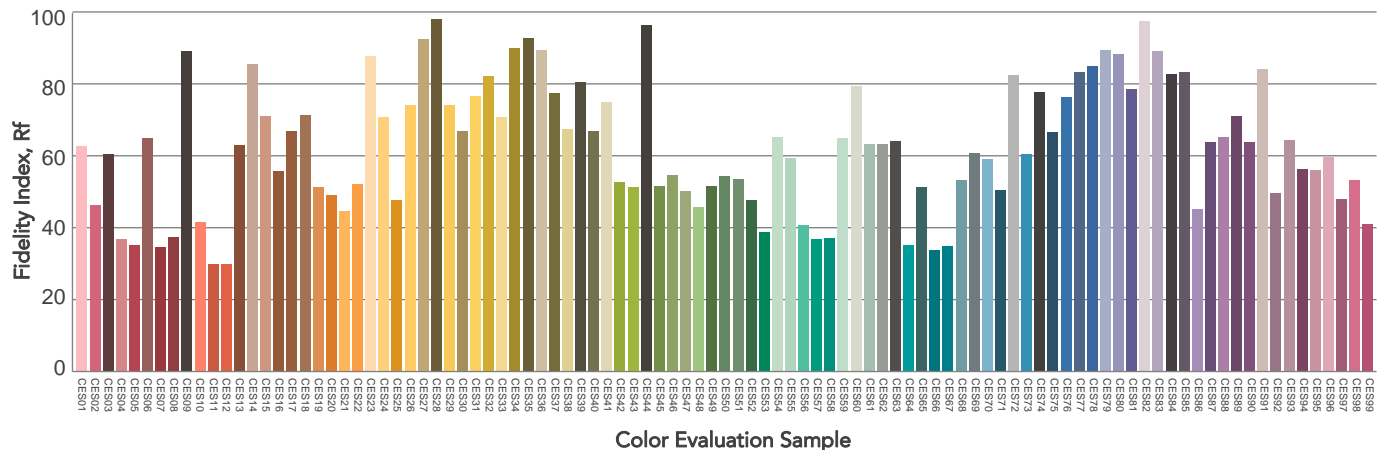
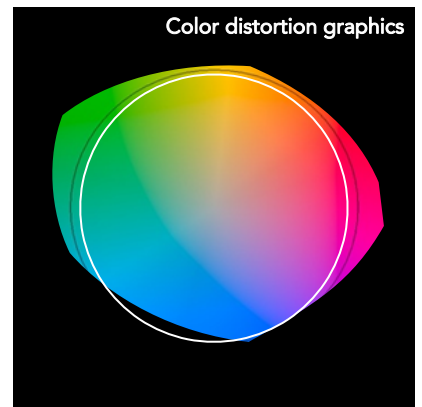
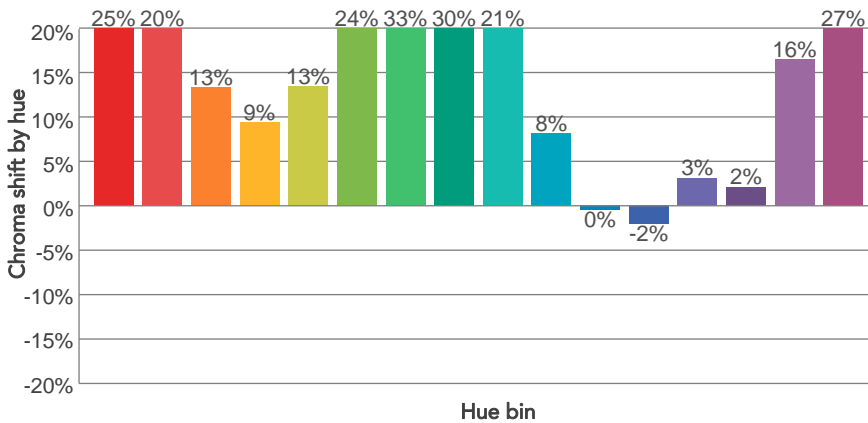
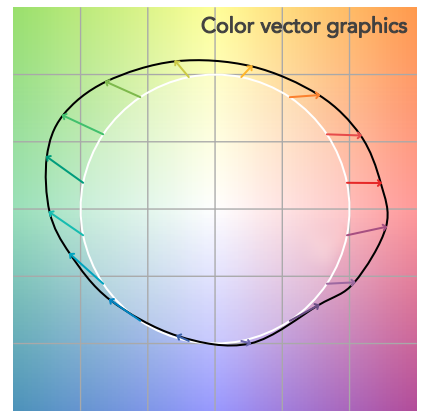
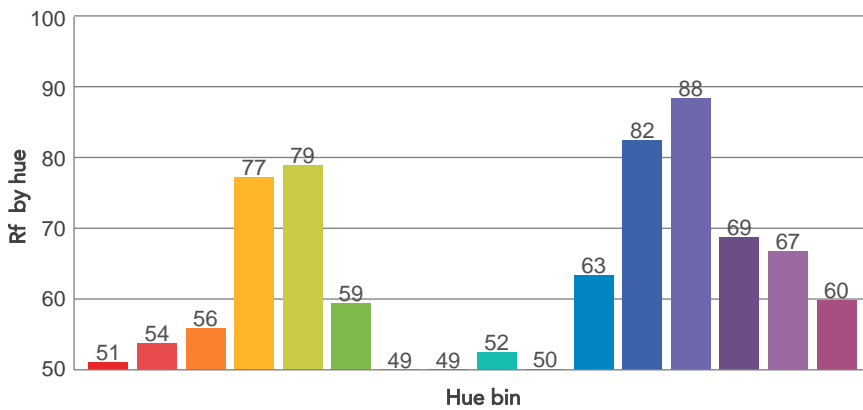
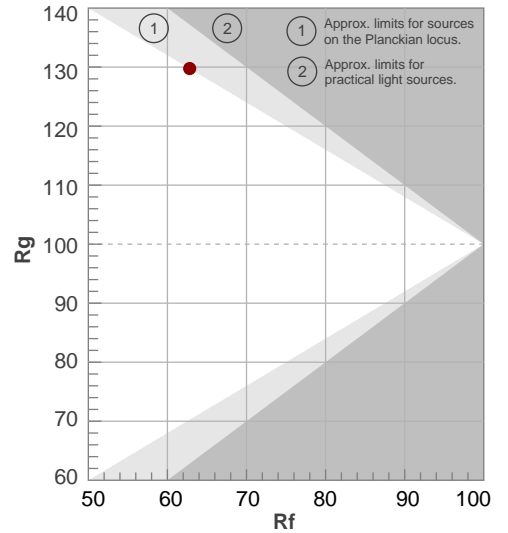

BEAM DETAILS



Beam angle 50%	Field angle 10%	Cut off angle 2,5%	Intensity ratio in 120° cone	Intensity ratio in 90° cone
37,9°	55,8°	66,9°	100,0%	100,0%

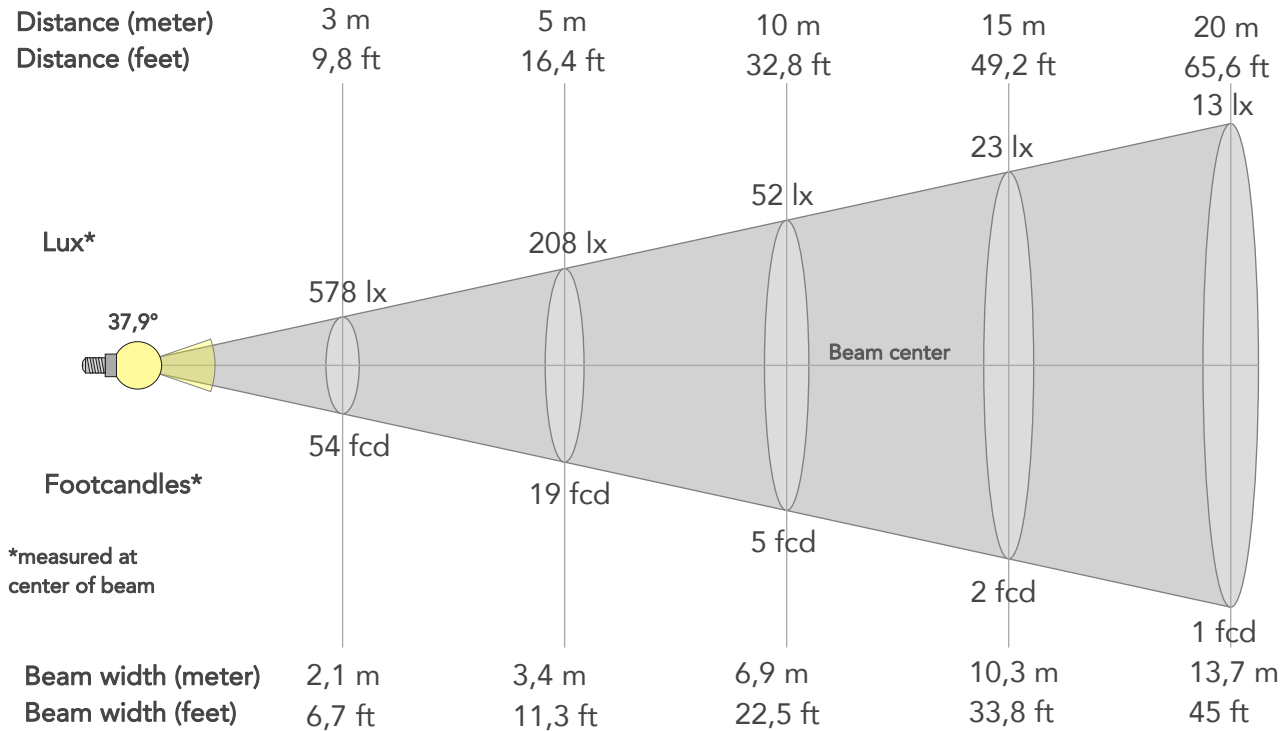

BEAM INTENSITIES AND WIDTHS

Distance	1m	2m	3m	4m	5m	7,5m	10m	15m	20m	25m	30m	40m	50m
Distance	3,3ft	6,6ft	9,8ft	13,1ft	16,4ft	24,6ft	32,8ft	49,2ft	65,6ft	82ft	98,4ft	131,2ft	164ft
Lux	5204lx	1301lx	578lx	325lx	208lx	93lx	52lx	23lx	13lx	8lx	6lx	3lx	2lx
Footcand.	483fcd	121fcd	54fcd	30fcd	19fcd	9fcd	5fcd	2fcd	1fcd	1fcd	1fcd	0fcd	0fcd
Beam wid.	0,7m	1,4m	2,1m	2,7m	3,4m	5,1m	6,9m	10,3m	13,7m	17,2m	20,6m	27,5m	34,3m
Beam wid.	2,3ft	4,5ft	6,7ft	9ft	11,3ft	16,9ft	22,5ft	33,8ft	45ft	56,3ft	67,6ft	90,1ft	112,6ft

LINEAR DISTRIBUTION DIAGRAM

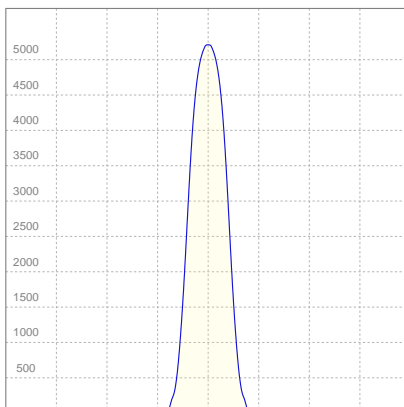

ELECTRICAL SPECIFICATIONS

Input voltage	Input current	Input power	Effeciency
223V	0,684A	133W	15lm/W

ISO CANDELA DIAGRAM

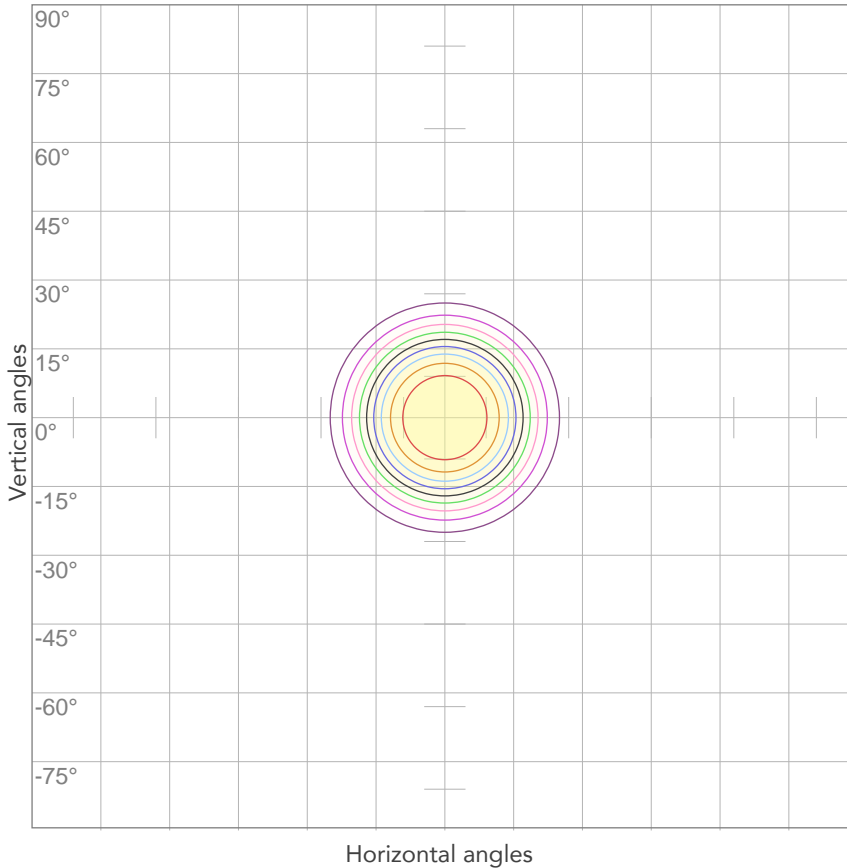

10%	520 cd
20%	1041 cd
30%	1561 cd
40%	2082 cd
50%	2602 cd
60%	3123 cd
70%	3643 cd
80%	4163 cd

Conditions:

Number of c-planes: 2

Candela at center: 5204 cd

ISO LUX DIAGRAM

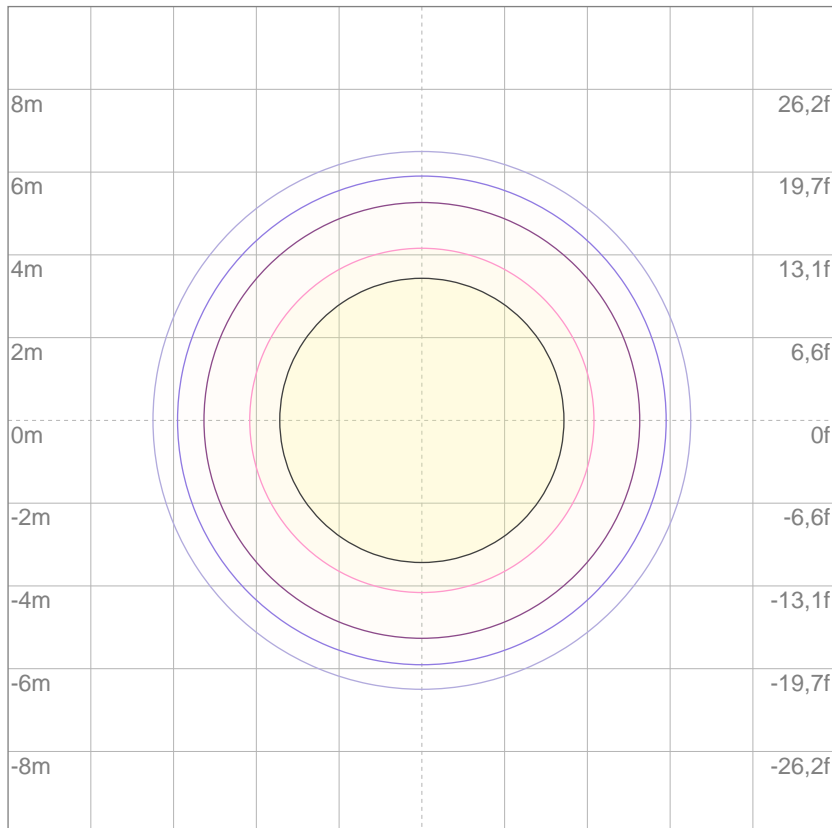

3%	1,56 lx
5%	2,60 lx
10%	5,20 lx
30%	15,6 lx
50%	26,0 lx

Conditions:

Number of c-planes: 2

Lux at center: 52,0 lx

Lux distribution on a surface when lamp is mounted at 10 meters from the surface.

Mounting height: 10 meters (33 feet)



Total lumen output:

1773 lm

Peak candela output:

20806 cd

Light quality:

CRI: 39,5

Color temperature:

2876 K

PRODUCT NAME:

ASTRAWASH7PIXIP

MEASURAMENT CONDITIONS:

Beam angle:

Med Zoom

Target:

2800K

Operator:

Paolo Carvone

Date and time:

16/02/2021 09:45:18

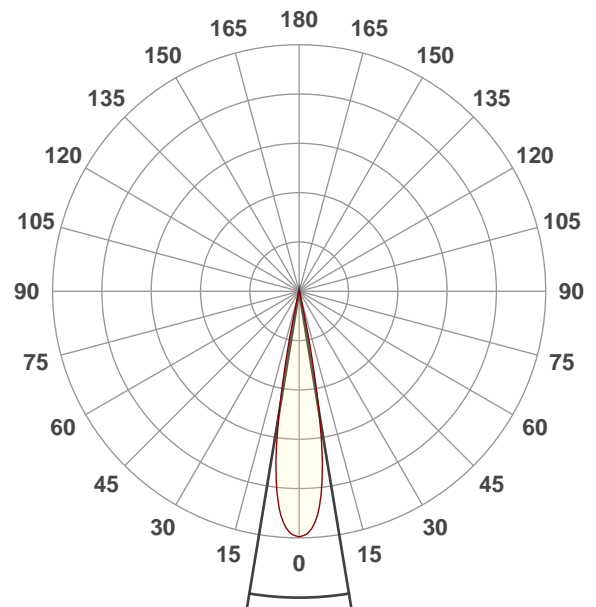

Beam angle 50%: 18,7°

Field angle 10%: 24,9°

Cut off angle 2.5%: 27,6°

Spectra

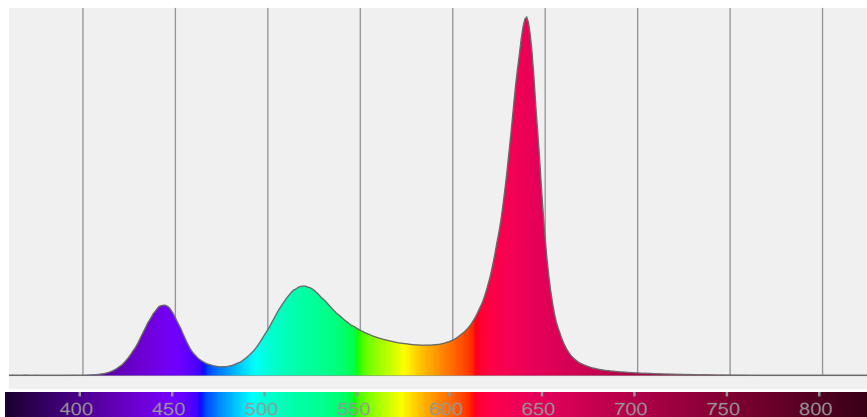

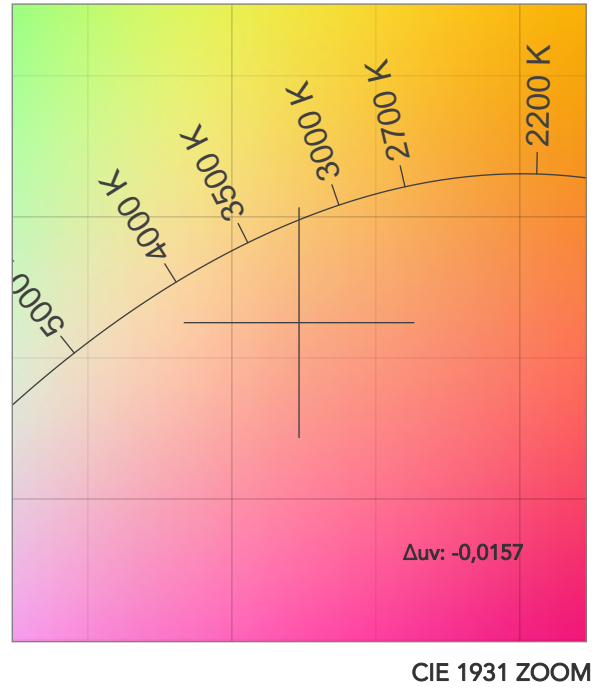
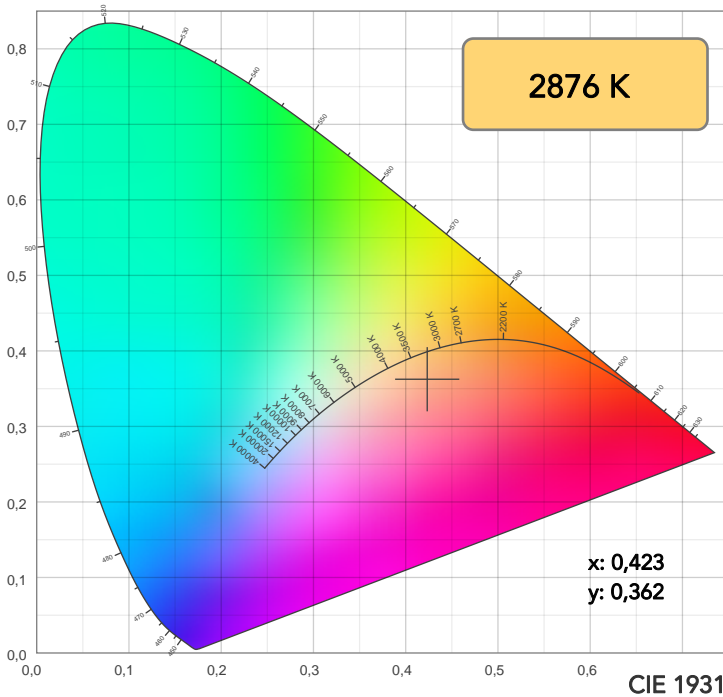

TM30: 62,8

CRI: 39,5 (R1-R8)

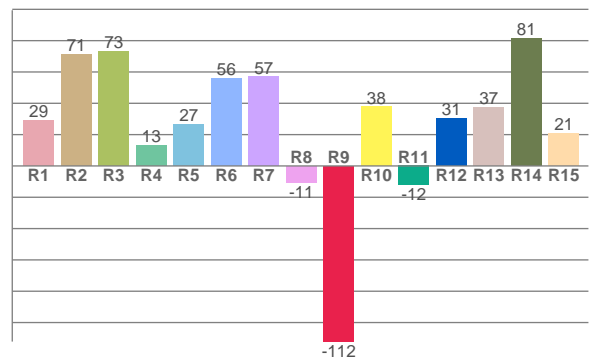
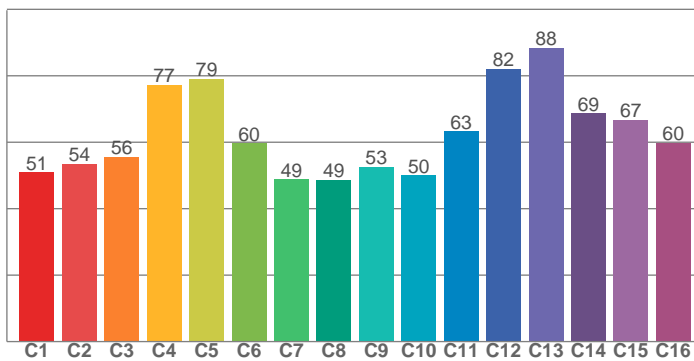

CRI R values, only R1-R8 are used to calculate final CRI value

R1	R2	R3	R4	R5	R6	R7	R8	R9	R10	R11	R12	R13	R14	R15
29,2	71,5	73,2	13,1	26,7	56,2	56,8	-10,8	-112,2	37,7	-12,2	30,5	37,2	81,2	20,8

TM30 C values, 16 binned values out of total of 99 C values

C1	C2	C3	C4	C5	C6	C7	C8	C9	C10	C11	C12	C13	C14	C15	C16
50,9	53,6	55,7	77,2	79,2	59,6	48,8	48,7	52,5	50,1	63,2	82,1	88,4	68,7	66,7	59,7

CQS Q values

Q1	Q2	Q3	Q4	Q5	Q6	Q7	Q8	Q9	Q10	Q11	Q12	Q13	Q14	Q15
77,8	93,0	79,6	48,5	44,1	51,1	88,1	75,8	84,6	87,2	64,6	57,4	60,9	79,3	81,7

CQS: 67,5

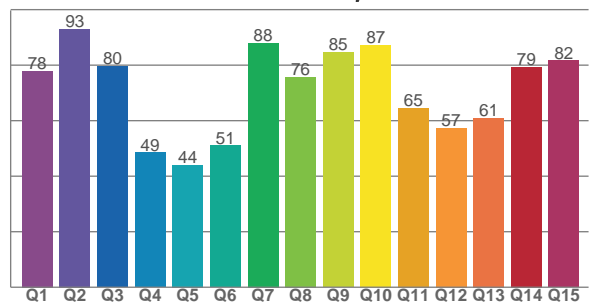

COLOR PARAMETERS

Color temperature	Color rendering index	Red component	Color fidelity	Color gamut	Color quality scale	Television lighting index	Color coordinate cie 1931	Color coordinate cie 1931	Color deviation from black body
CCT	CRI	CRI R9	TM30 Rf	TM30 Rg	CQS	TLCI	x	y	Δuv
2876 K	39,5	-112,2	62,8	129,7	67,5	24	0,423	0,362	-0,0157

TM30 DETAILS

Rf 62,8
Fidelity index Rf

Rg 129,7
Gammut index

Hue Bin	R _f	Graphic shifts (%)	
		Chroma	Hue
1	51	25%	-5%
2	54	20%	-15%
3	56	13%	-17%
4	77	9%	-6%
5	79	13%	7%
6	60	24%	15%
7	49	33%	5%
8	49	30%	-14%
9	53	21%	-22%
10	50	8%	-32%
11	63	0%	-28%
12	82	-2%	-9%
13	88	3%	6%
14	69	2%	24%
15	67	16%	12%
16	60	27%	12%

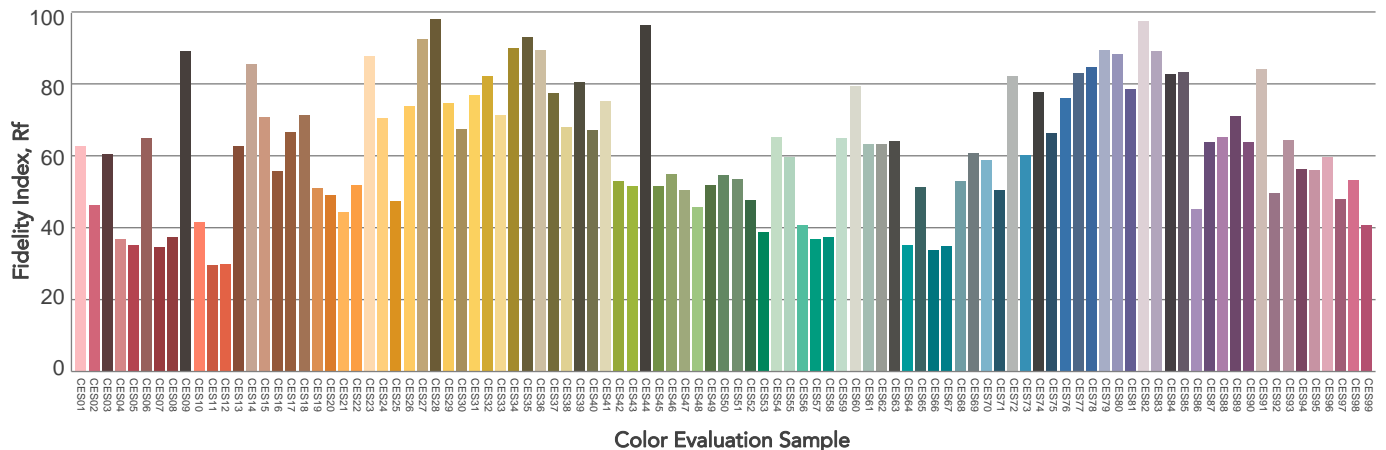
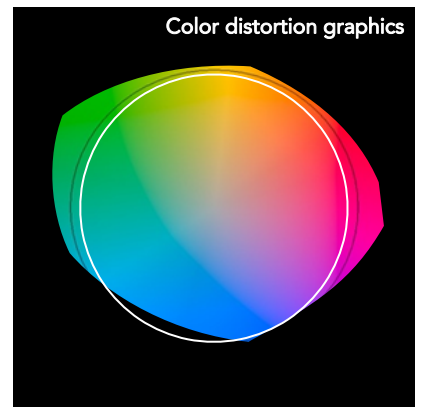
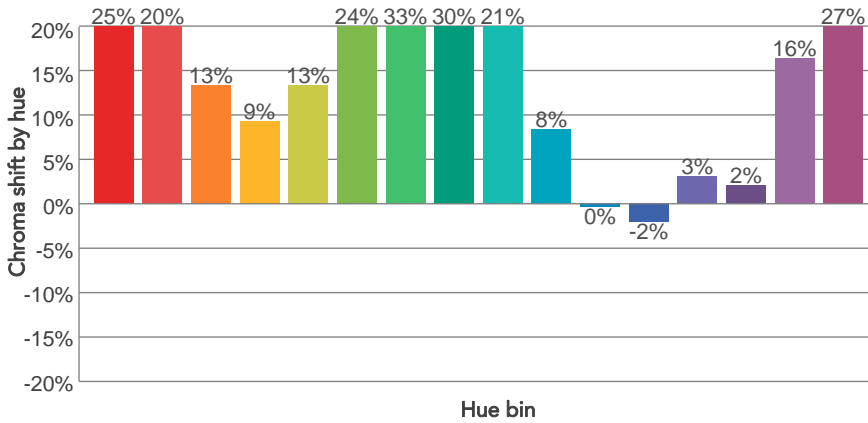
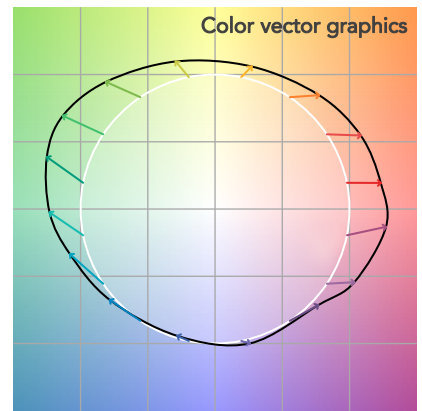
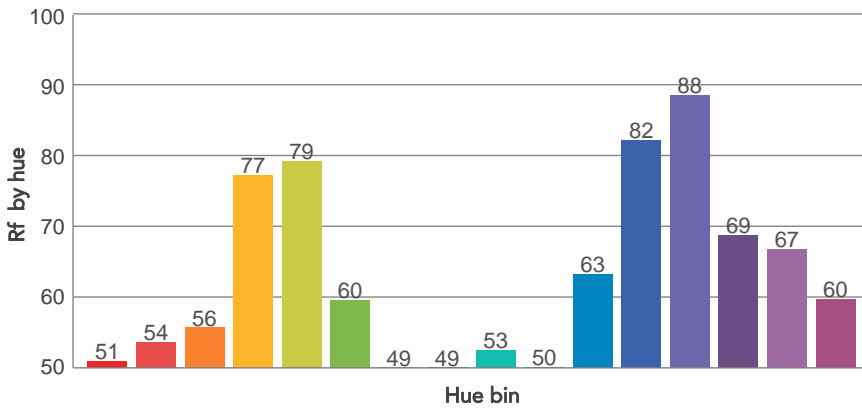
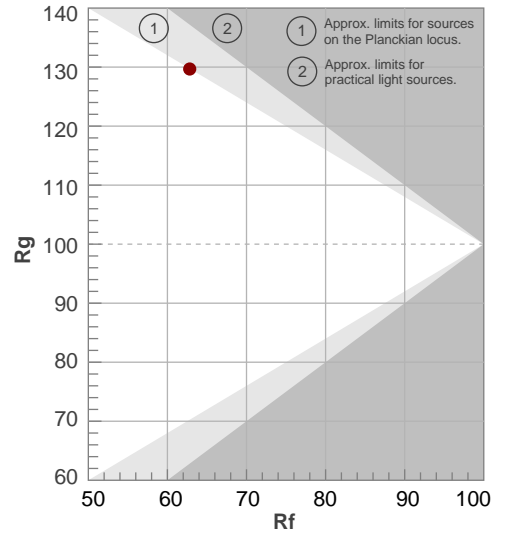

BEAM DETAILS



Beam angle 50%	Field angle 10%	Cut off angle 2,5%	Intensity ratio in 120° cone	Intensity ratio in 90° cone
18,7°	24,9°	27,6°	100,0%	100,0%

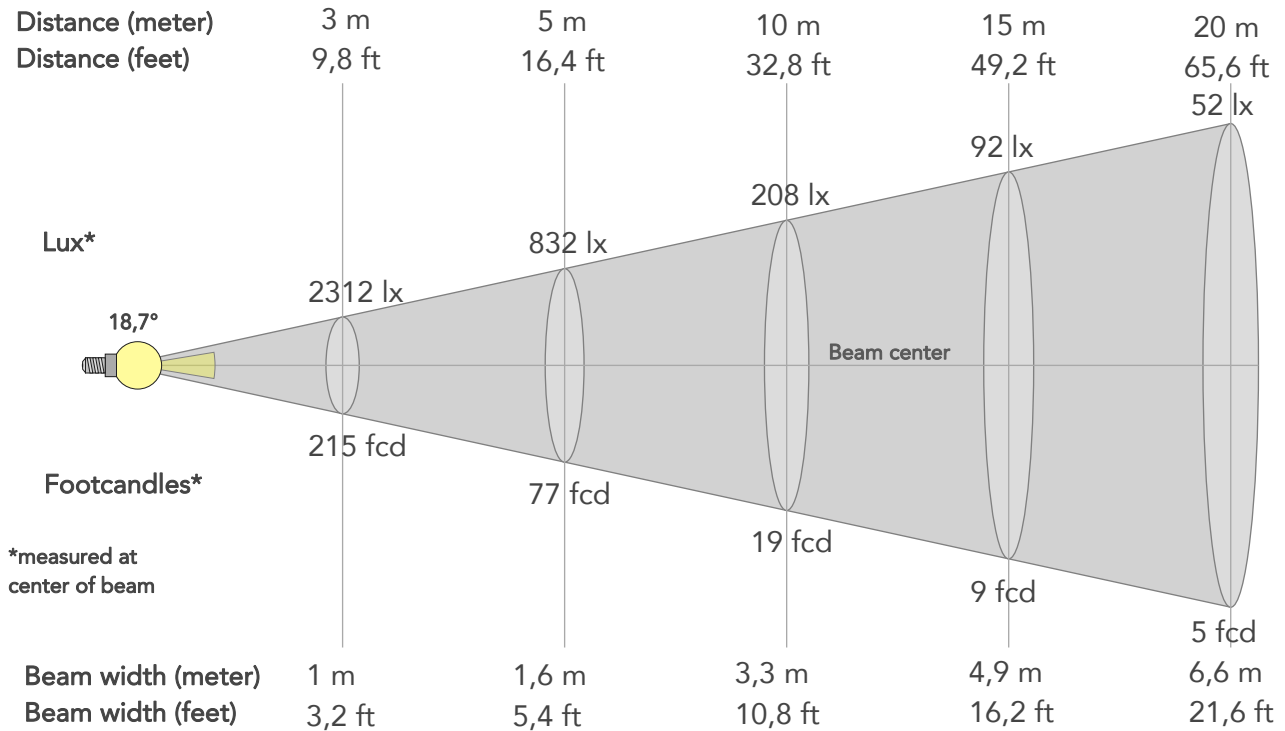

BEAM INTENSITIES AND WIDTHS

Distance	1m	2m	3m	4m	5m	7,5m	10m	15m	20m	25m	30m	40m	50m
Distance	3,3ft	6,6ft	9,8ft	13,1ft	16,4ft	24,6ft	32,8ft	49,2ft	65,6ft	82ft	98,4ft	131,2ft	164ft
Lux	2080lx	5202lx	2312lx	1300lx	832lx	370lx	208lx	92lx	52lx	33lx	23lx	13lx	8lx
Footcand.	1933fcd	483fcd	215fcd	121fcd	77fcd	34fcd	19fcd	9fcd	5fcd	3fcd	2fcd	1fcd	1fcd
Beam wid.	0,3m	0,7m	1m	1,3m	1,6m	2,5m	3,3m	4,9m	6,6m	8,2m	9,9m	13,2m	16,5m
Beam wid.	1,1ft	2,2ft	3,2ft	4,3ft	5,4ft	8,1ft	10,8ft	16,2ft	21,6ft	27ft	32,4ft	43,2ft	54ft

LINEAR DISTRIBUTION DIAGRAM

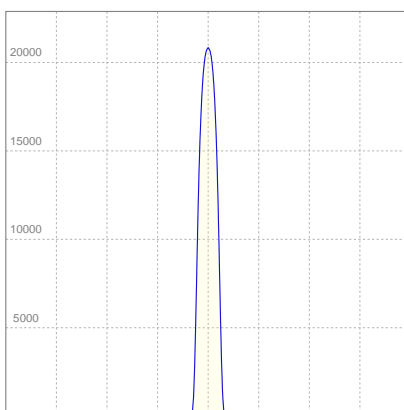

ELECTRICAL SPECIFICATIONS

Input voltage	Input current	Input power	Effeciency
222V	0,686A	133,1W	13lm/W

ISO CANDELA DIAGRAM

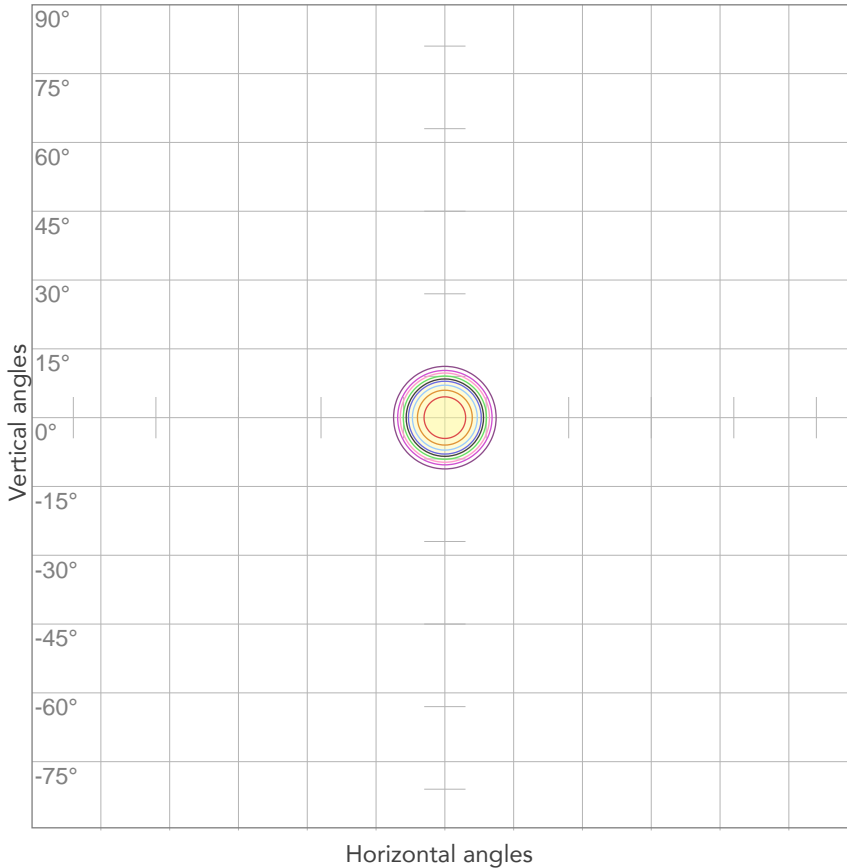

10%	2081 cd
20%	4161 cd
30%	6242 cd
40%	8322 cd
50%	10403 cd
60%	12484 cd
70%	14564 cd
80%	16645 cd

Conditions:

Number of c-planes: 2

Candela at center: 20806 cd

ISO LUX DIAGRAM

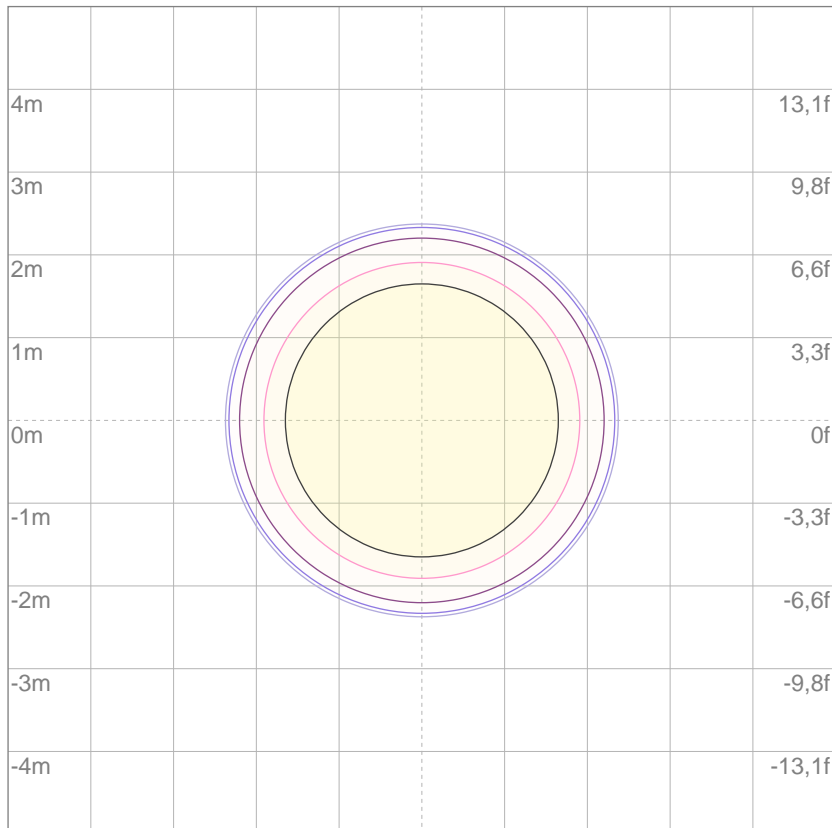

3%	6,24 lx
5%	10,4 lx
10%	20,8 lx
30%	62,4 lx
50%	104 lx

Conditions:

Number of c-planes: 2

Lux at center: 208 lx

Lux distribution on a surface when lamp is mounted at 10 meters from the surface.

Mounting height: 10 meters (33 feet)



Total lumen output:

1201 lm

Peak candela output:

257522 cd

Light quality:

CRI: 38,2

Color temperature:

2823 K

PRODUCT NAME:

ASTRAWASH7PIXIP

MEASUREMENT CONDITIONS:

Beam angle:

Min Zoom

Target:

2800K

Operator:

Paolo Carvone

Date and time:

16/02/2021 09:43:23

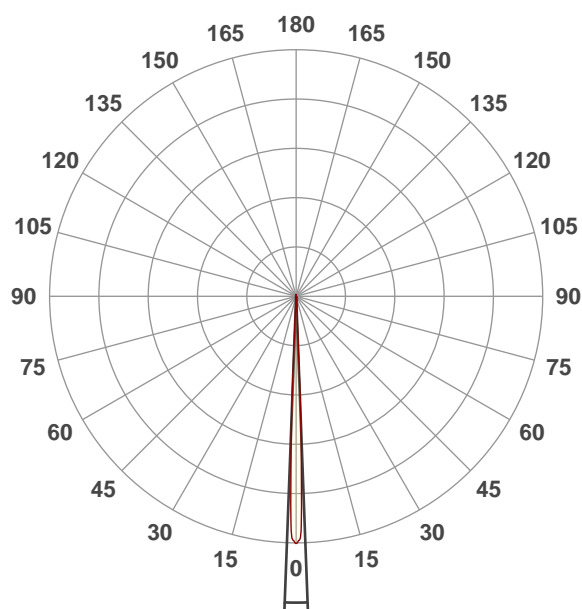

Beam angle 50%: 4,3°

Field angle 10%: 5,8°

Cut off angle 2.5%: 6,9°

Spectra

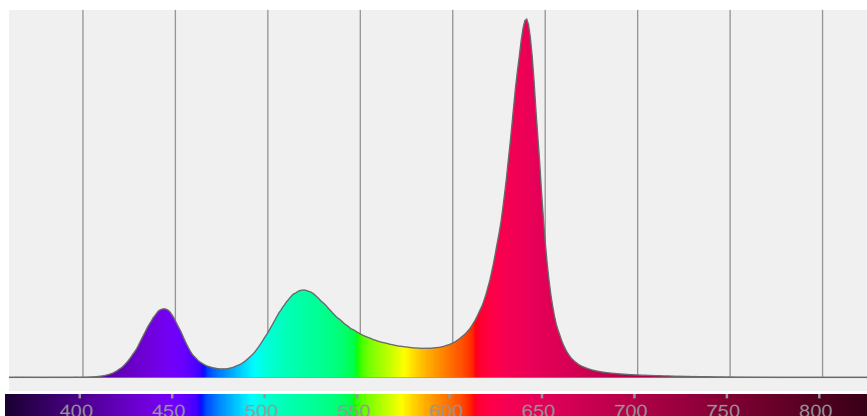

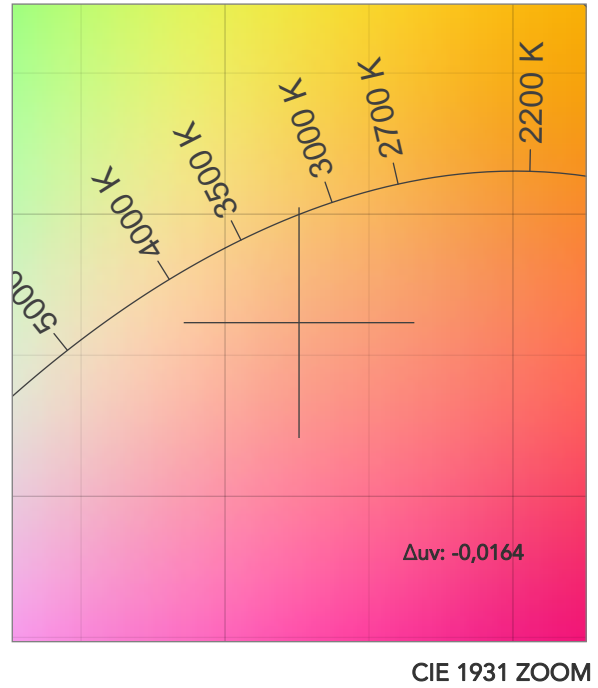
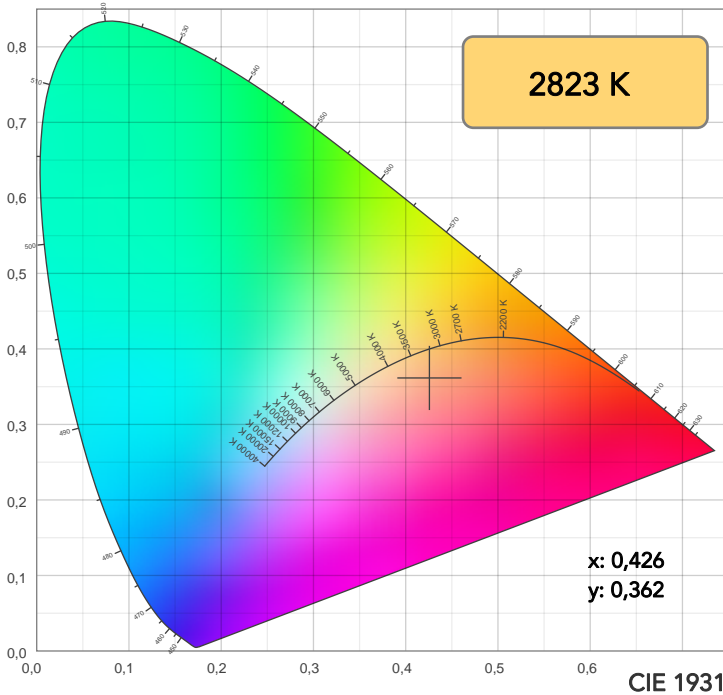

TM30: 62,0

CRI: 38,2 (R1-R8)

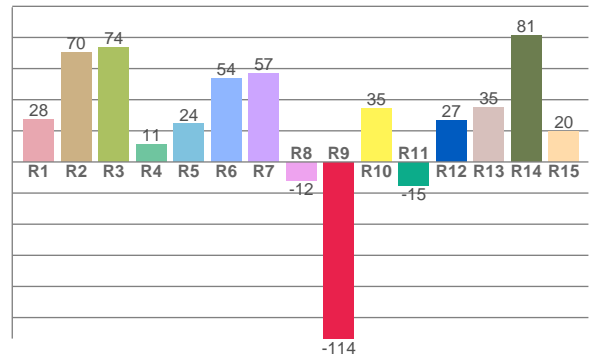
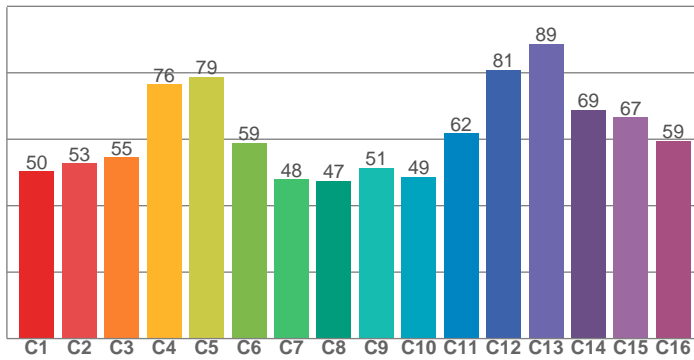

CRI R values, only R1-R8 are used to calculate final CRI value

R1	R2	R3	R4	R5	R6	R7	R8	R9	R10	R11	R12	R13	R14	R15
27,5	70,1	73,8	11,3	24,4	53,8	56,9	-11,9	-113,5	34,7	-15,0	26,6	35,3	81,5	19,6

TM30 C values, 16 binned values out of total of 99 C values

C1	C2	C3	C4	C5	C6	C7	C8	C9	C10	C11	C12	C13	C14	C15	C16
50,3	52,8	54,5	76,5	78,7	58,9	47,9	47,4	51,4	48,6	61,8	81,0	88,7	68,9	66,6	59,5

CQS Q values

Q1	Q2	Q3	Q4	Q5	Q6	Q7	Q8	Q9	Q10	Q11	Q12	Q13	Q14	Q15
77,8	93,1	78,8	47,3	42,9	49,8	87,3	76,0	84,9	86,7	64,2	57,1	60,7	78,9	81,3

CQS: 66,9

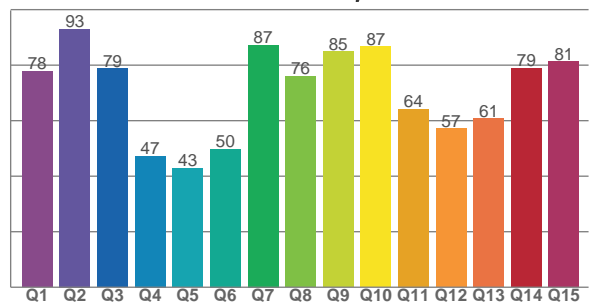

COLOR PARAMETERS

Color temperature	Color rendering index	Red component	Color fidelity	Color gamut	Color quality scale	Television lighting index	Color coordinate cie 1931	Color coordinate cie 1931	Color deviation from black body
CCT	CRI	CRI R9	TM30 Rf	TM30 Rg	CQS	TLCI	x	y	Δuv
2823 K	38,2	-113,5	62,0	130,3	66,9	24	0,426	0,362	-0,0164

TM30 DETAILS

Rf 62,0
Fidelity index Rf

Rg 130,3
Gammut index

Hue Bin	R _f	Graphic shifts (%)	
		Chroma	Hue
1	50	25%	-5%
2	53	21%	-15%
3	55	14%	-18%
4	76	10%	-6%
5	79	14%	7%
6	59	24%	15%
7	48	33%	5%
8	47	31%	-14%
9	51	22%	-22%
10	49	9%	-33%
11	62	0%	-29%
12	81	-2%	-10%
13	89	3%	5%
14	69	2%	24%
15	67	16%	12%
16	59	27%	12%

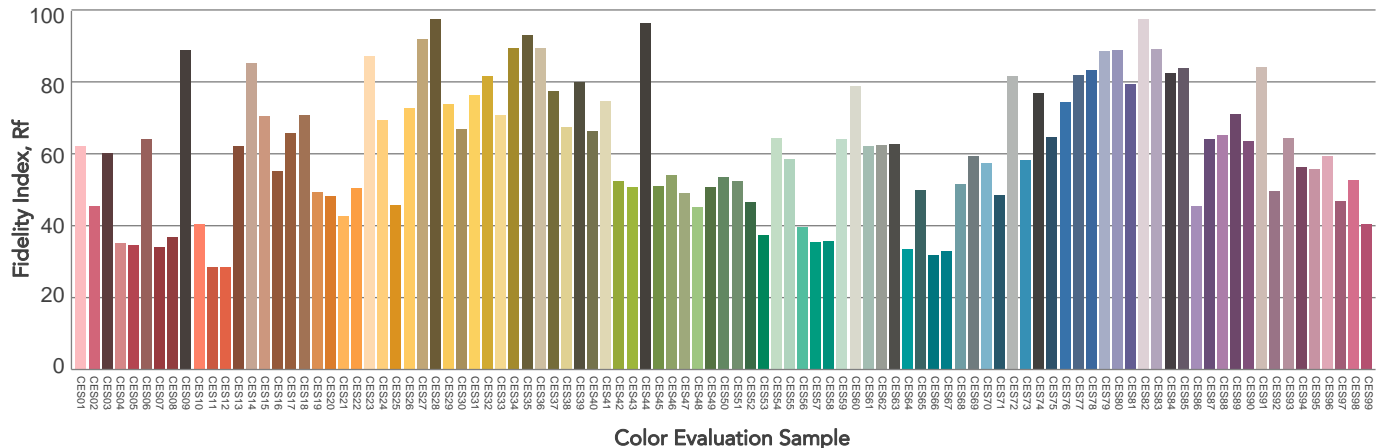
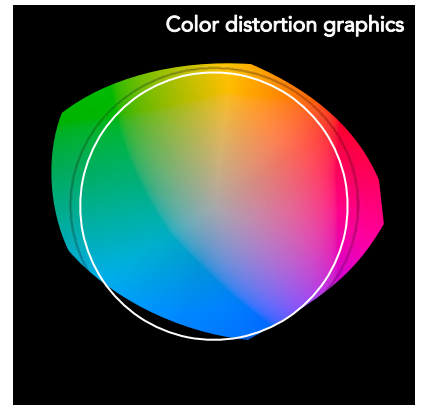
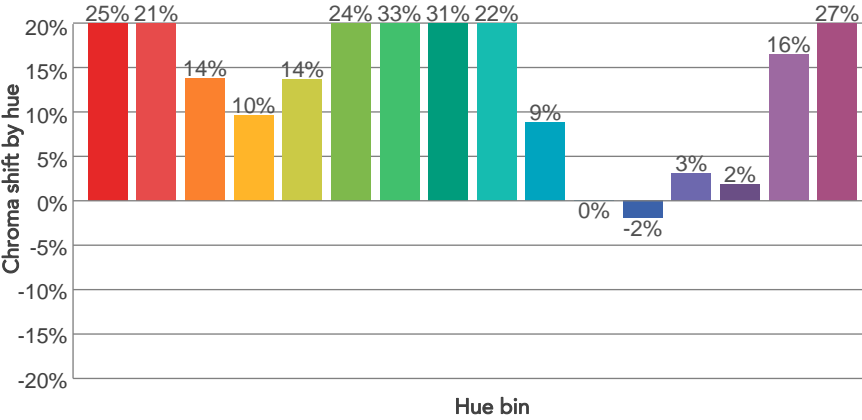
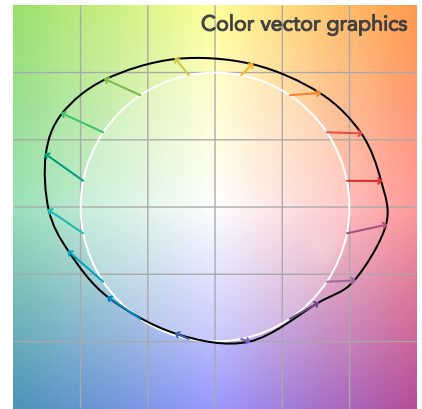
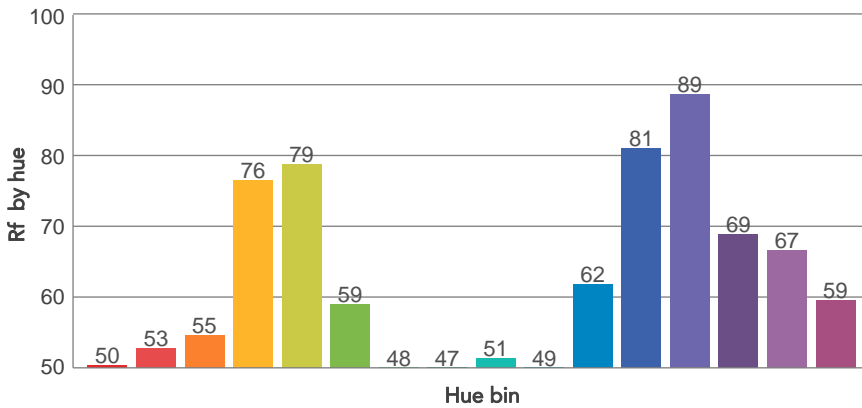
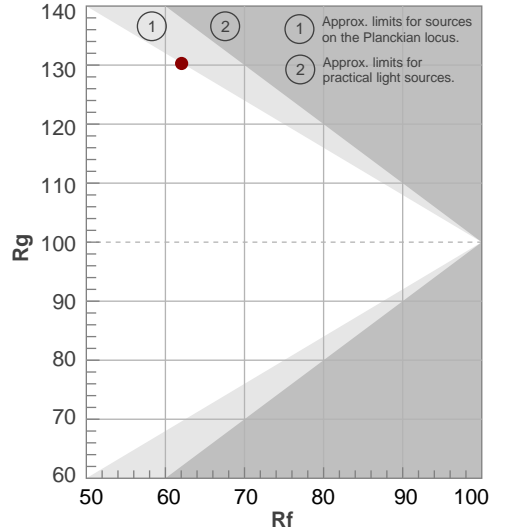

BEAM DETAILS



Beam angle 50%	Field angle 10%	Cut off angle 2,5%	Intensity ratio in 120° cone	Intensity ratio in 90° cone
4,3°	5,8°	6,9°	100,0%	100,0%

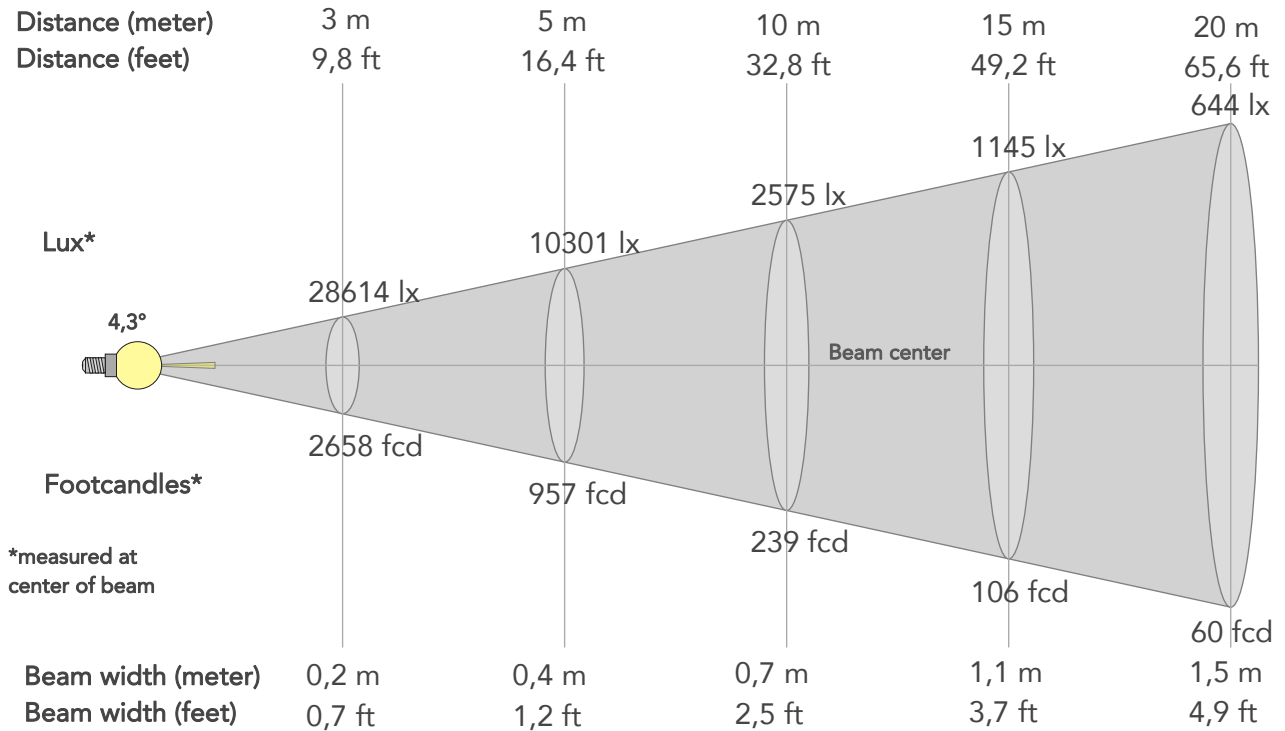

BEAM INTENSITIES AND WIDTHS

Distance	1m	2m	3m	4m	5m	7,5m	10m	15m	20m	25m	30m	40m	50m
Distance	3,3ft	6,6ft	9,8ft	13,1ft	16,4ft	24,6ft	32,8ft	49,2ft	65,6ft	82ft	98,4ft	131,2ft	164ft
Lux	257522lx	64380lx	28614lx	16095lx	10301lx	4578lx	2575lx	1145lx	644lx	412lx	286lx	161lx	103lx
Footcand.	23925fcd	5981fcd	2658fcd	1495fcd	957fcd	425fcd	239fcd	106fcd	60fcd	38fcd	27fcd	15fcd	10fcd
Beam wid.	0,1m	0,1m	0,2m	0,3m	0,4m	0,6m	0,7m	1,1m	1,5m	1,9m	2,2m	3m	3,7m
Beam wid.	0,2ft	0,5ft	0,7ft	1ft	1,2ft	1,8ft	2,5ft	3,7ft	4,9ft	6,1ft	7,4ft	9,8ft	12,3ft

LINEAR DISTRIBUTION DIAGRAM

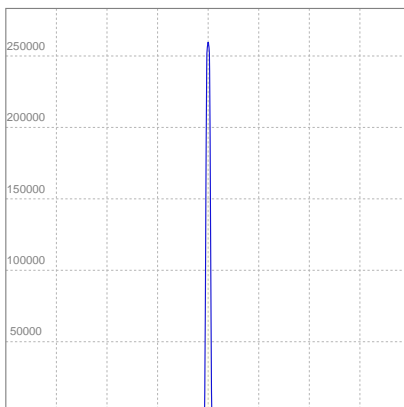

ELECTRICAL SPECIFICATIONS

Input voltage	Input current	Input power	Effeciency
223V	0,683A	132,9W	9lm/W

ISO CANDELA DIAGRAM

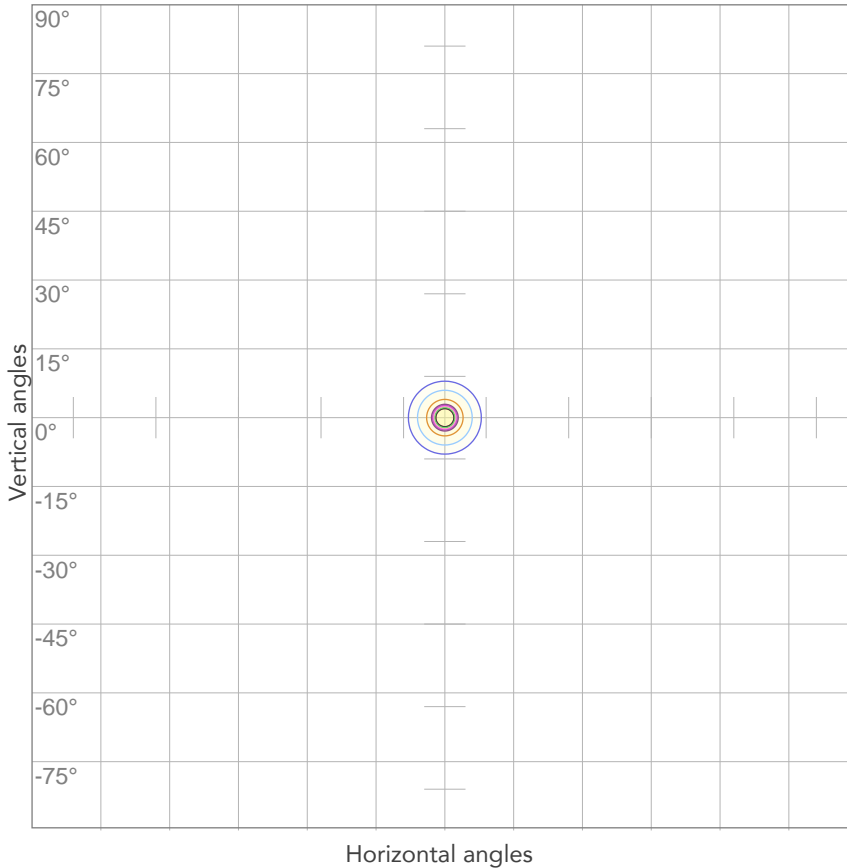

10%	25752 cd
20%	51504 cd
30%	77257 cd
40%	103009 cd
50%	128761 cd
60%	154513 cd
70%	180265 cd
80%	206018 cd

Conditions:

Number of c-planes: 2

Candela at center: 257522 cd

ISO LUX DIAGRAM

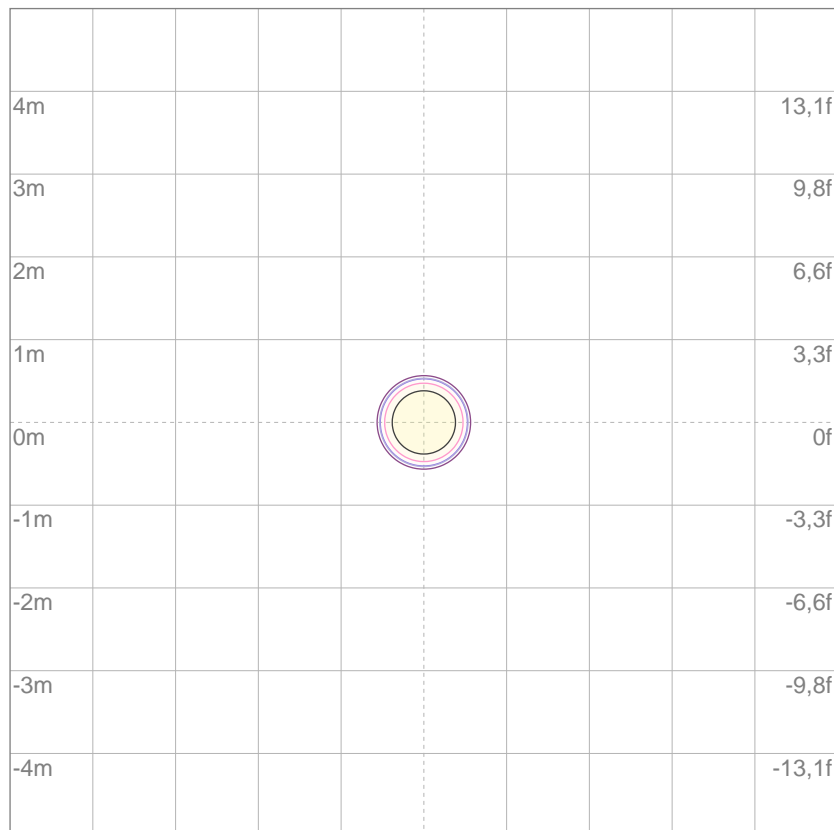

3%	77,3 lx
5%	129 lx
10%	258 lx
30%	773 lx
50%	1288 lx

Conditions:

Number of c-planes: 2

Lux at center: 2575 lx

Lux distribution on a surface when lamp is mounted at 10 meters from the surface.



Total lumen output:

2324 lm

Peak candela output:

5952 cd

Light quality:

CRI: 49,4

Color temperature:

3293 K

PRODUCT NAME:

ASTRAWASH7PIXIP

MEASUREMENT CONDITIONS:

Beam angle:

Max Zoom

Target:

3200K

Operator:

Paolo Carvone

Date and time:

16/02/2021 10:07:31

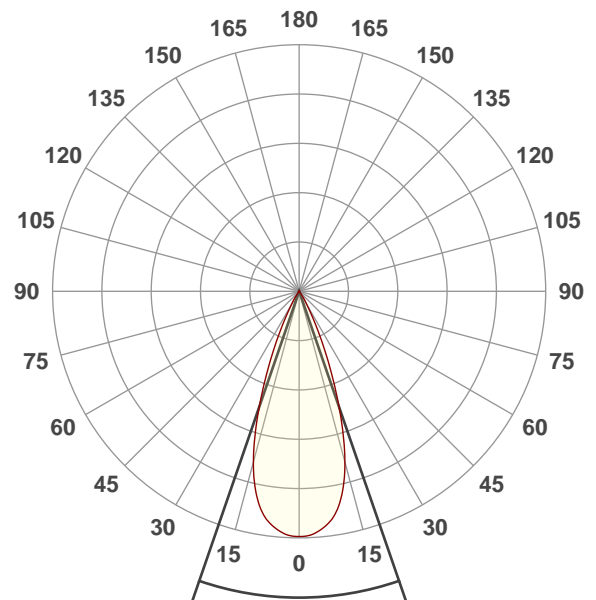

Beam angle 50%: 38,1°

Field angle 10%: 56,3°

Cut off angle 2.5%: 67,7°

Spectra

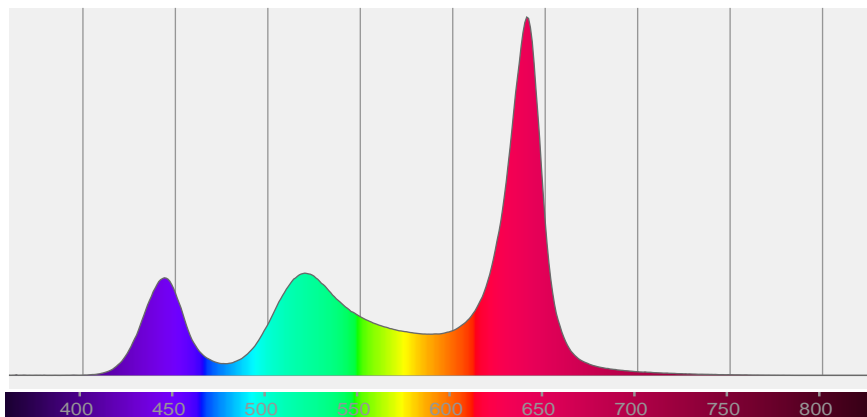

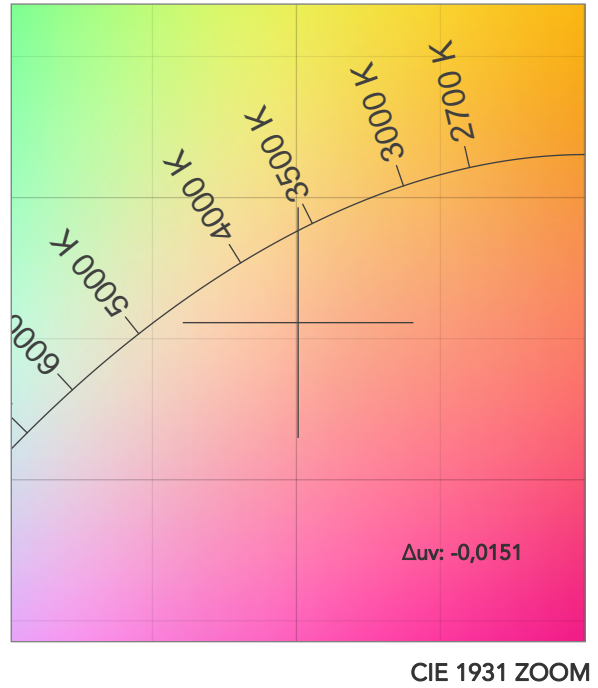
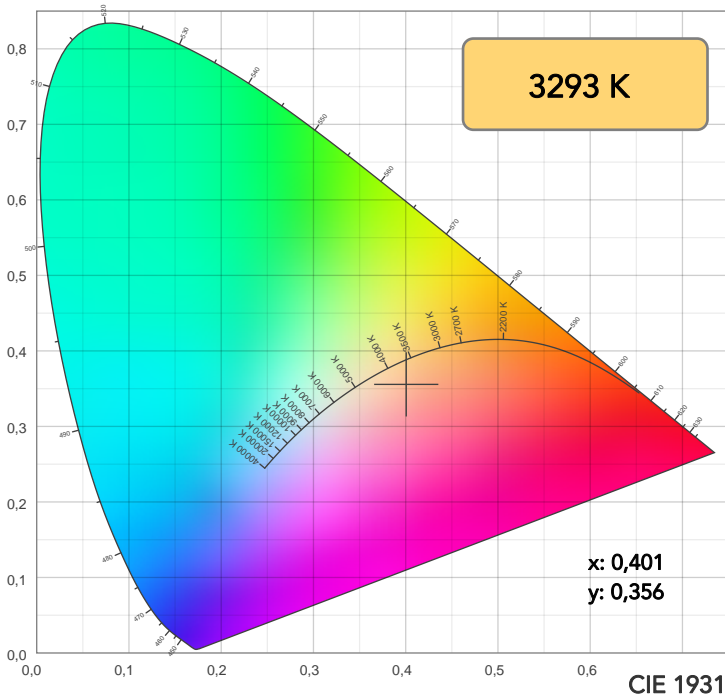

TM30: 68,8

CRI: 49,4 (R1-R8)

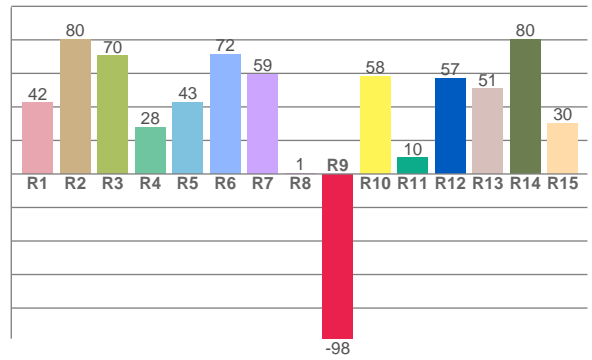
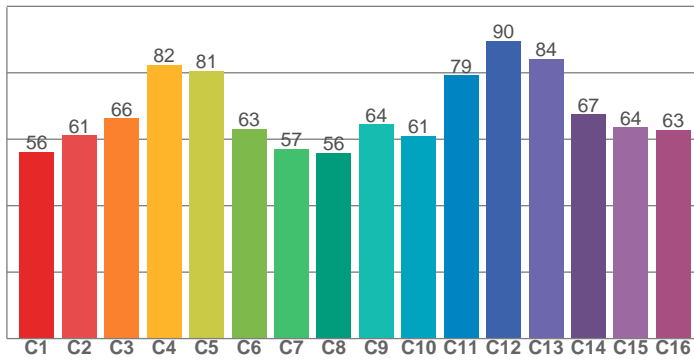

CRI R values, only R1-R8 are used to calculate final CRI value

R1	R2	R3	R4	R5	R6	R7	R8	R9	R10	R11	R12	R13	R14	R15
42,4	80,1	70,4	27,9	42,6	71,6	59,4	0,6	-98,2	58,0	9,6	57,0	50,7	80,2	30,3

TM30 C values, 16 binned values out of total of 99 C values

C1	C2	C3	C4	C5	C6	C7	C8	C9	C10	C11	C12	C13	C14	C15	C16
56,1	61,2	66,2	82,3	80,5	63,0	57,1	55,9	64,5	61,1	79,2	89,6	84,1	67,5	63,5	62,9

CQS Q values

Q1	Q2	Q3	Q4	Q5	Q6	Q7	Q8	Q9	Q10	Q11	Q12	Q13	Q14	Q15
79,0	91,1	90,9	63,0	55,2	59,8	90,9	78,1	82,4	94,2	73,8	65,6	66,7	82,5	84,3

CQS: 74,0

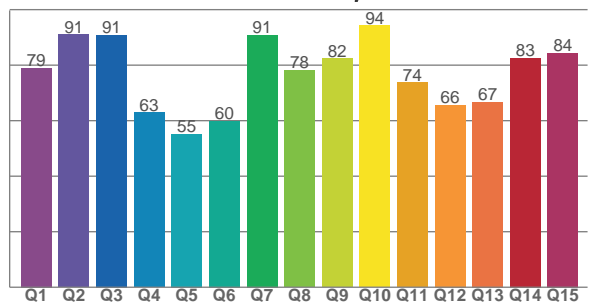

COLOR PARAMETERS

Color temperature	Color rendering index	Red component	Color fidelity	Color gamut	Color quality scale	Television lighting index	Color coordinate cie 1931	Color coordinate cie 1931	Color deviation from black body
CCT	CRI	CRI R9	TM30 Rf	TM30 Rg	CQS	TLCI	x	y	Δuv
3293 K	49,4	-98,2	68,8	127,4	74,0	34	0,401	0,356	-0,0151

TM30 DETAILS

Rf 68,8
Fidelity index Rf

Rg 127,4
Gammut index

Hue Bin	R _f	Graphic shifts (%)	
		Chroma	Hue
1	56	23%	-4%
2	61	17%	-12%
3	66	11%	-12%
4	82	7%	-3%
5	81	13%	7%
6	63	21%	13%
7	57	29%	3%
8	56	24%	-12%
9	64	17%	-18%
10	61	6%	-26%
11	79	-1%	-12%
12	90	-1%	-1%
13	84	4%	11%
14	67	6%	26%
15	64	17%	18%
16	63	25%	4%

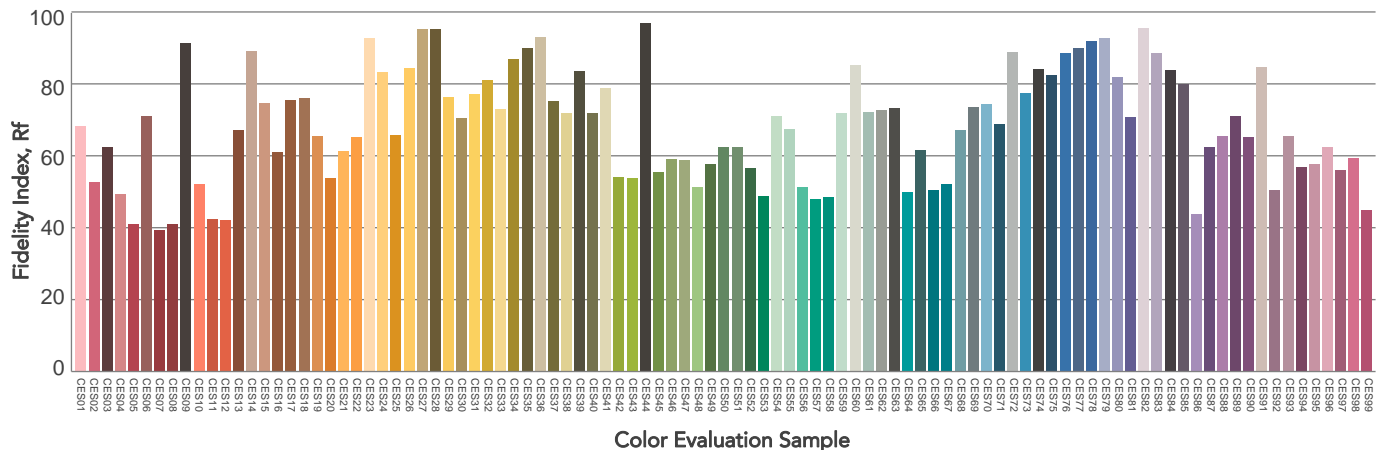
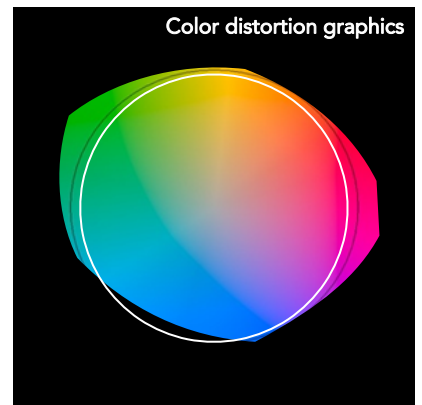
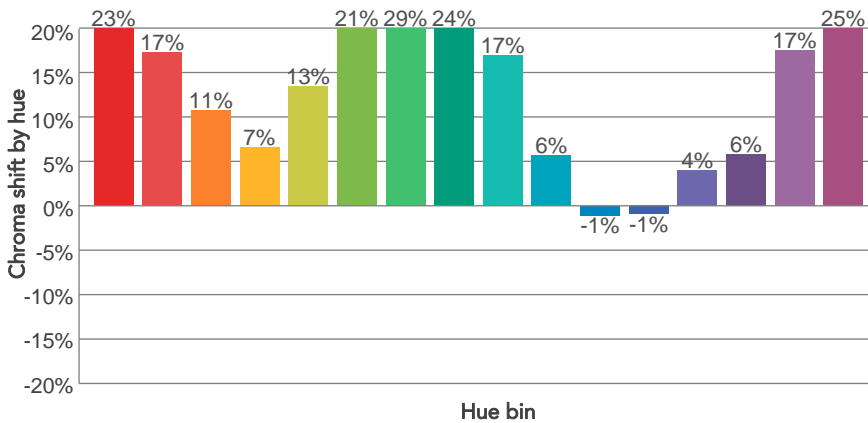
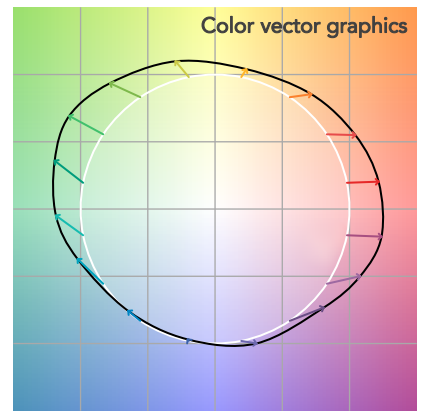
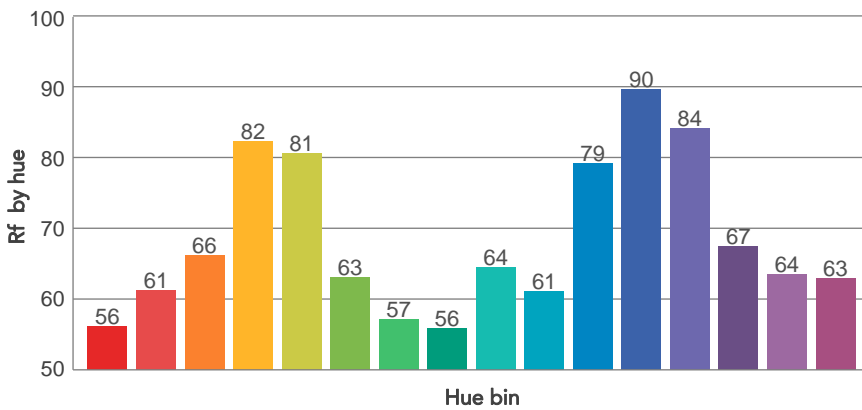
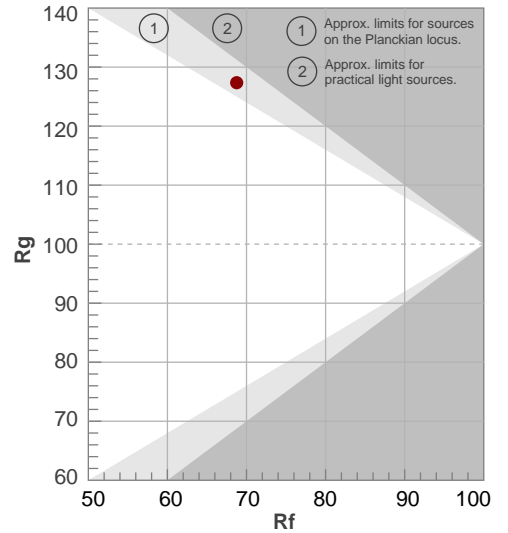

BEAM DETAILS



Beam angle 50%	Field angle 10%	Cut off angle 2,5%	Intensity ratio in 120° cone	Intensity ratio in 90° cone
38,1°	56,3°	67,7°	100,0%	100,0%

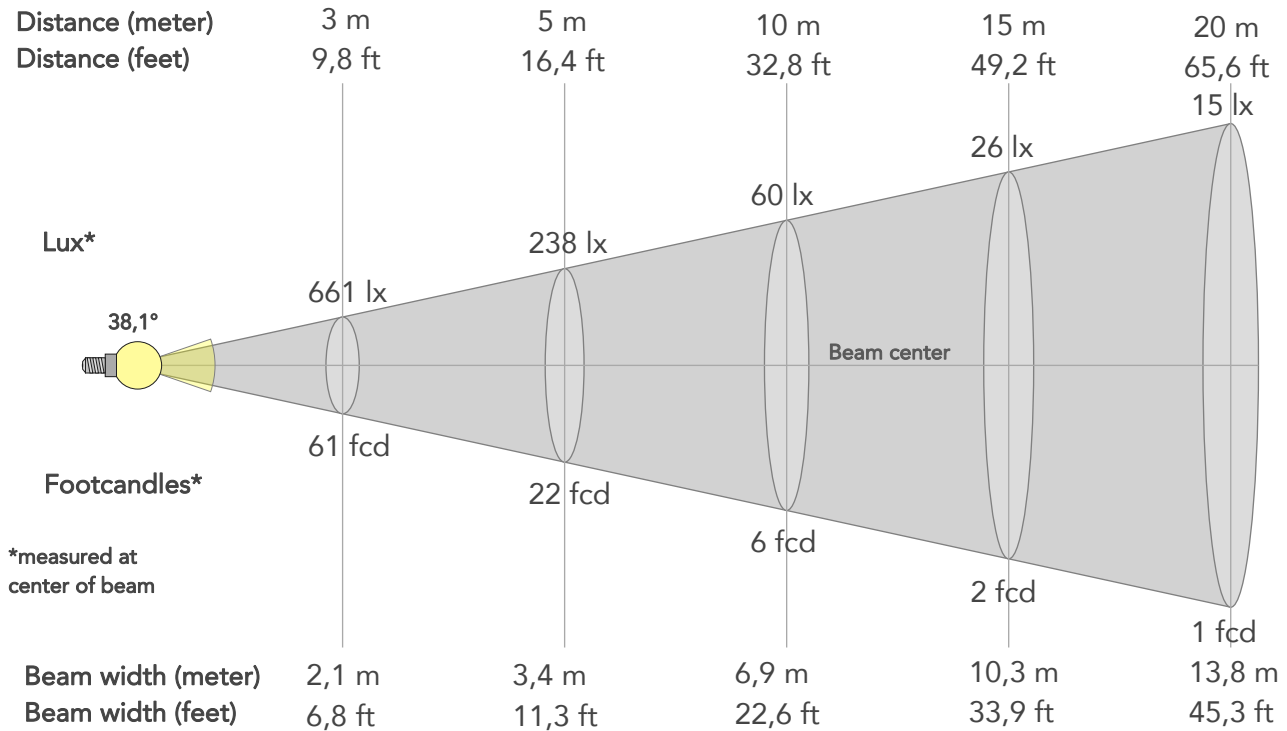

BEAM INTENSITIES AND WIDTHS

Distance	1m	2m	3m	4m	5m	7,5m	10m	15m	20m	25m	30m	40m	50m
Distance	3,3ft	6,6ft	9,8ft	13,1ft	16,4ft	24,6ft	32,8ft	49,2ft	65,6ft	82ft	98,4ft	131,2ft	164ft
Lux	5952lx	1488lx	661lx	372lx	238lx	106lx	60lx	26lx	15lx	10lx	7lx	4lx	2lx
Footcand.	553fcd	138fcd	61fcd	35fcd	22fcd	10fcd	6fcd	2fcd	1fcd	1fcd	1fcd	0fcd	0fcd
Beam wid.	0,7m	1,4m	2,1m	2,8m	3,4m	5,2m	6,9m	10,3m	13,8m	17,2m	20,7m	27,6m	34,5m
Beam wid.	2,3ft	4,6ft	6,8ft	9ft	11,3ft	17ft	22,6ft	33,9ft	45,3ft	56,6ft	67,9ft	90,5ft	113,1ft

LINEAR DISTRIBUTION DIAGRAM

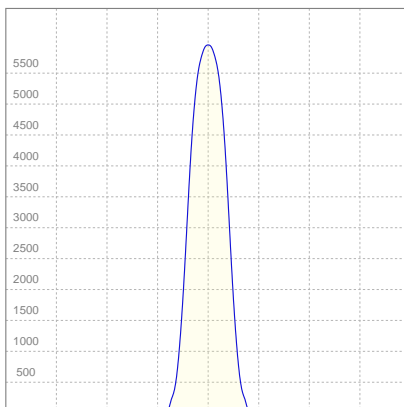

ELECTRICAL SPECIFICATIONS

Input voltage	Input current	Input power	Effeciency
223V	0,721A	141,6W	16lm/W

ISO CANDELA DIAGRAM

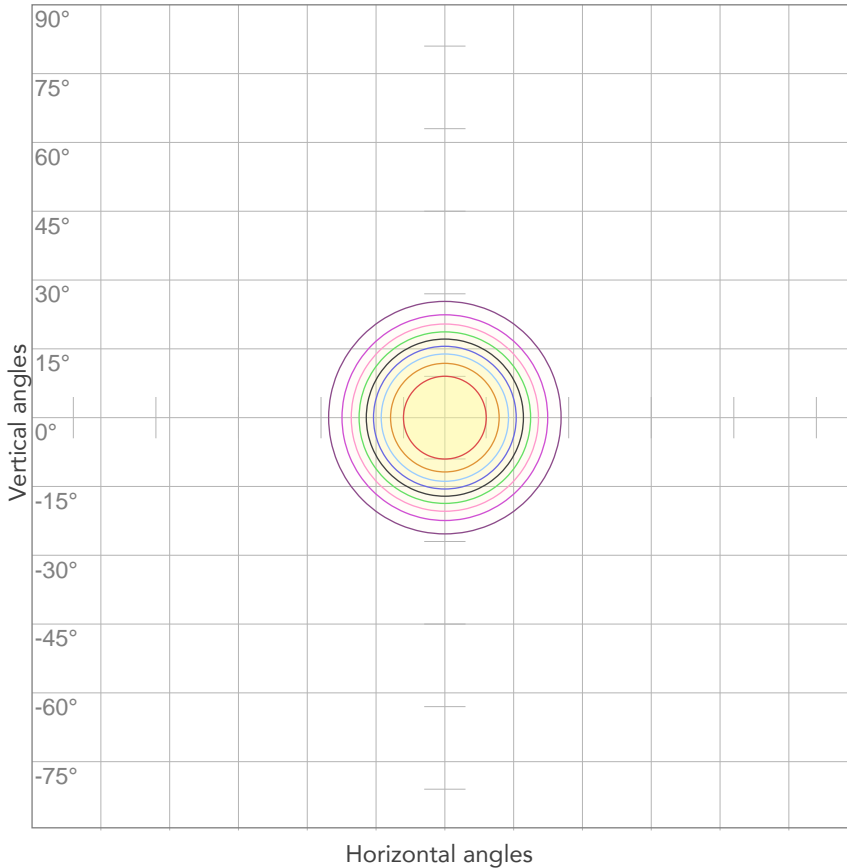

10%	595 cd
20%	1190 cd
30%	1785 cd
40%	2381 cd
50%	2976 cd
60%	3571 cd
70%	4166 cd
80%	4761 cd

Conditions:

Number of c-planes: 2

Candela at center: 5952 cd

ISO LUX DIAGRAM

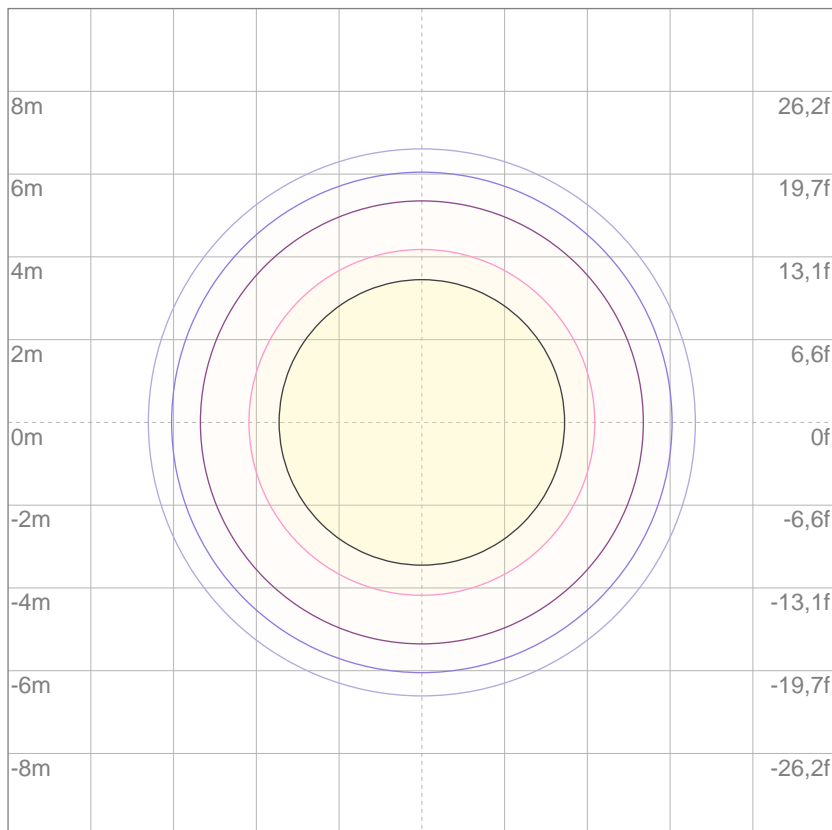

3%	1,79 lx
5%	2,98 lx
10%	5,95 lx
30%	17,9 lx
50%	29,8 lx

Conditions:

Number of c-planes: 2

Lux at center: 59,5 lx

Lux distribution on a surface when lamp is mounted at 10 meters from the surface.

Mounting height: 10 meters (33 feet)



Total lumen output:

2032 lm

Peak candela output:

23465 cd

Light quality:

CRI: 48,9

Color temperature:

3280 K

PRODUCT NAME:

ASTRAWASH7PIXIP

MEASUREMENT CONDITIONS:

Beam angle:

Med Zoom

Target:

3200K

Operator:

Paolo Carvone

Date and time:

16/02/2021 10:05:48

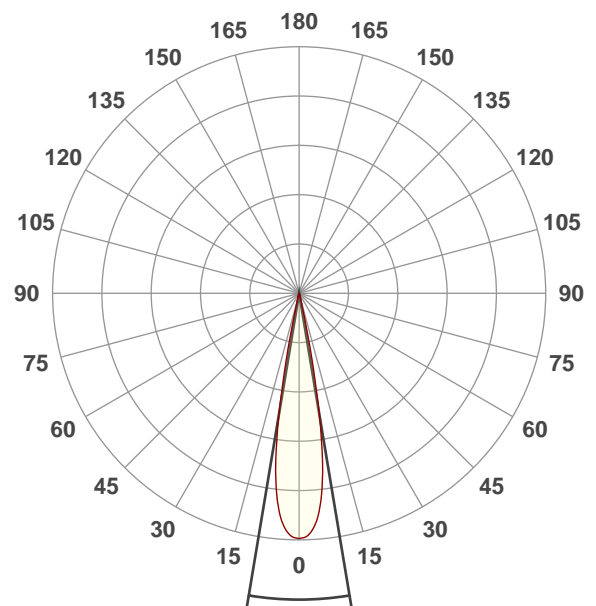

Beam angle 50%: 18,9°

Field angle 10%: 24,9°

Cut off angle 2.5%: 27,6°

Spectra

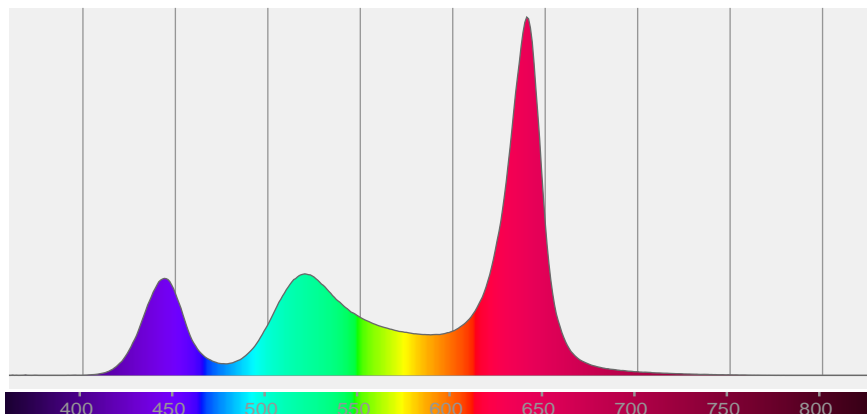

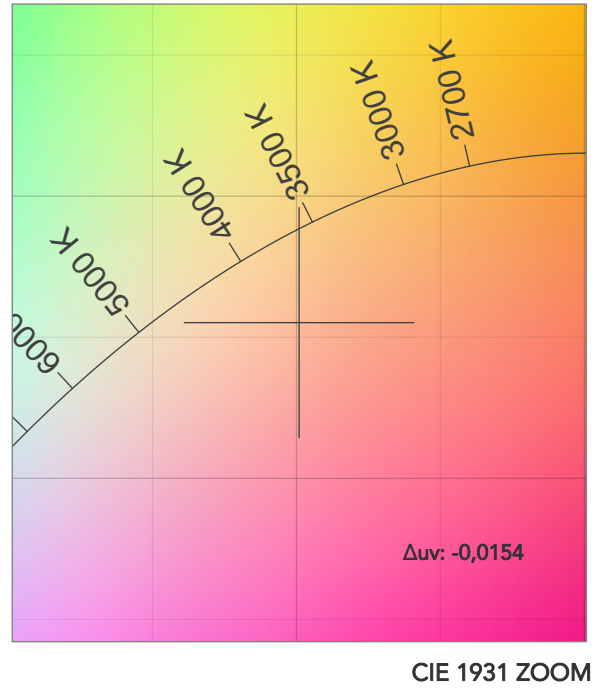
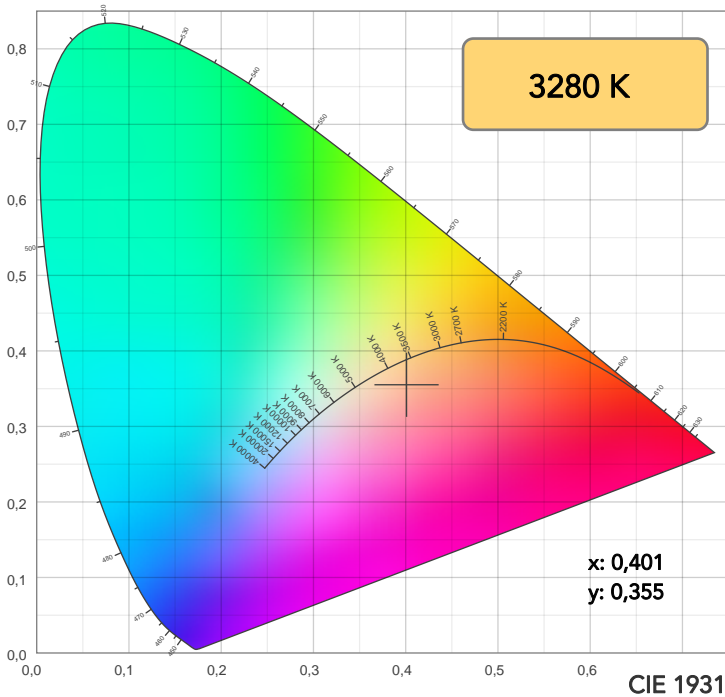

TM30: 68,5

CRI: 48,9 (R1-R8)

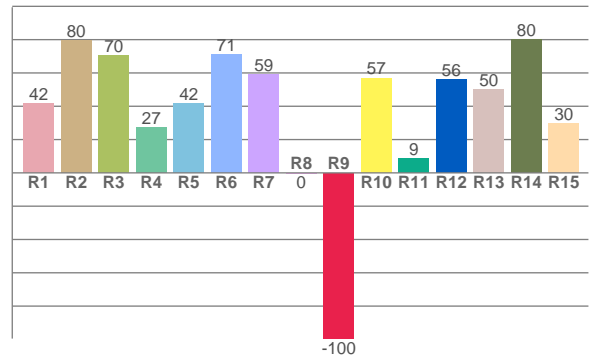
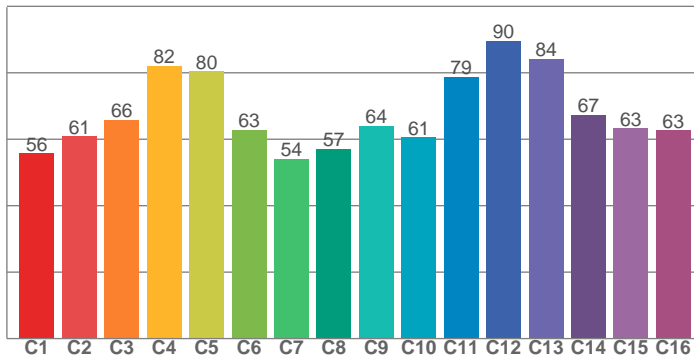

CRI R values, only R1-R8 are used to calculate final CRI value

R1	R2	R3	R4	R5	R6	R7	R8	R9	R10	R11	R12	R13	R14	R15
41,7	79,7	70,5	27,2	41,9	70,9	59,2	-0,2	-99,5	57,0	8,6	55,9	50,1	80,2	29,6

TM30 C values, 16 binned values out of total of 99 C values

C1	C2	C3	C4	C5	C6	C7	C8	C9	C10	C11	C12	C13	C14	C15	C16
55,8	60,8	65,8	82,1	80,4	62,8	54,1	57,1	64,1	60,6	78,8	89,6	84,2	67,4	63,3	62,6

CQS Q values

Q1	Q2	Q3	Q4	Q5	Q6	Q7	Q8	Q9	Q10	Q11	Q12	Q13	Q14	Q15
78,9	91,0	90,7	62,5	54,8	59,5	90,8	78,0	82,3	94,1	73,5	65,3	66,5	82,3	84,2

CQS: 73,8

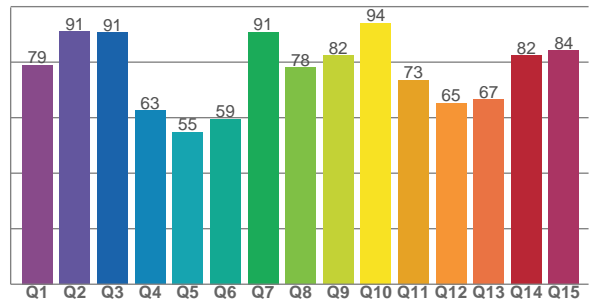

COLOR PARAMETERS

Color temperature	Color rendering index	Red component	Color fidelity	Color gamut	Color quality scale	Television lighting index	Color coordinate cie 1931	Color coordinate cie 1931	Color deviation from black body
CCT	CRI	CRI R9	TM30 Rf	TM30 Rg	CQS	TLCI	x	y	Δuv
3280 K	48,9	-99,5	68,5	127,6	73,8	34	0,401	0,355	-0,0154

TM30 DETAILS

Rf 68,5
Fidelity index Rf

Rg 127,6
Gammut index

Hue Bin	R _f	Graphic shifts (%)	
		Chroma	Hue
1	56	23%	-4%
2	61	17%	-12%
3	66	11%	-12%
4	82	7%	-3%
5	80	14%	7%
6	63	21%	13%
7	54	29%	4%
8	57	25%	-12%
9	64	17%	-18%
10	61	6%	-26%
11	79	-1%	-12%
12	90	-1%	-1%
13	84	4%	11%
14	67	6%	26%
15	63	18%	19%
16	63	26%	4%

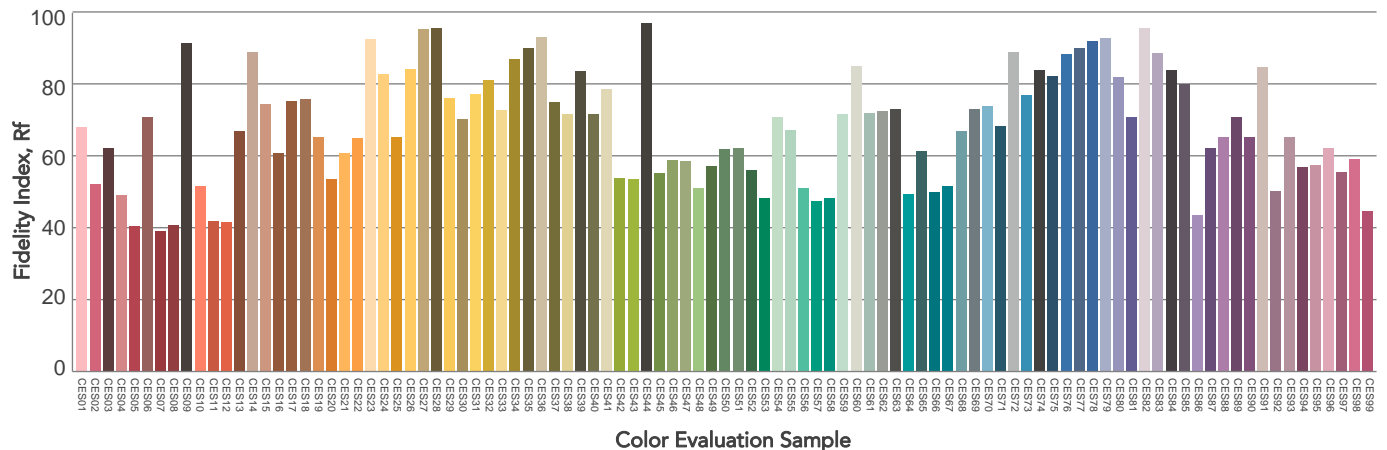
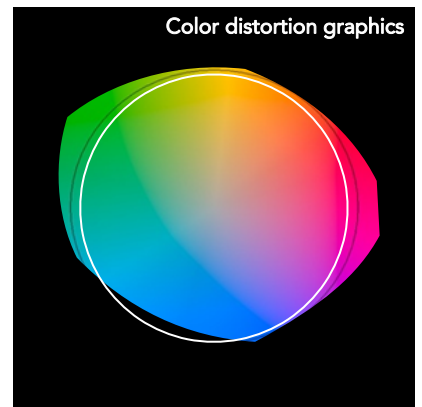
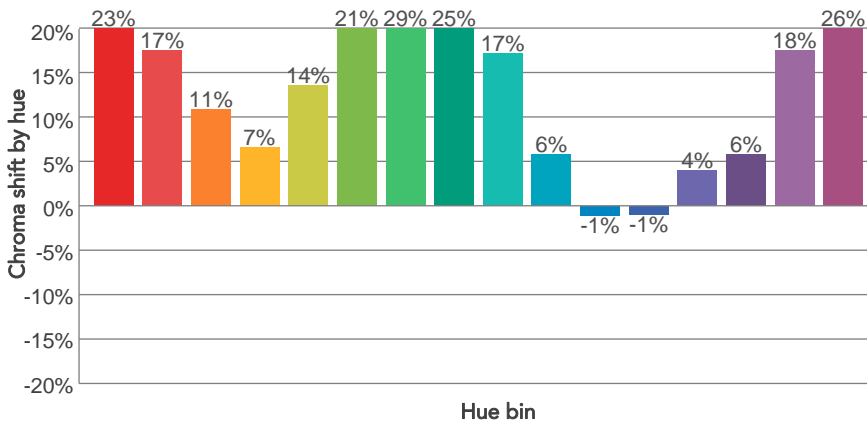
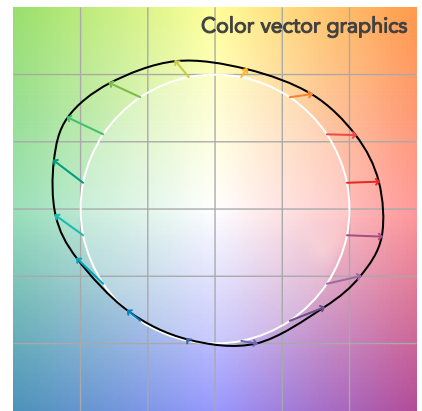
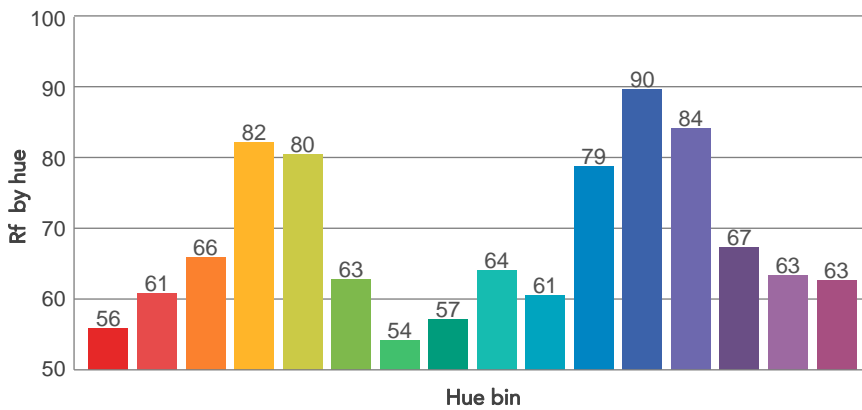
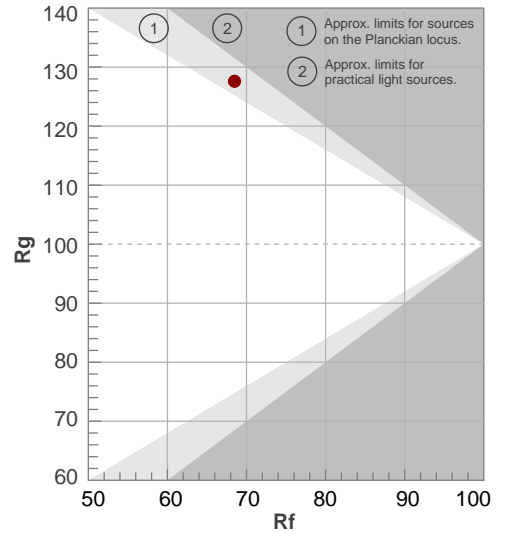

BEAM DETAILS



Beam angle 50%	Field angle 10%	Cut off angle 2,5%	Intensity ratio in 120° cone	Intensity ratio in 90° cone
18,9°	24,9°	27,6°	100,0%	100,0%

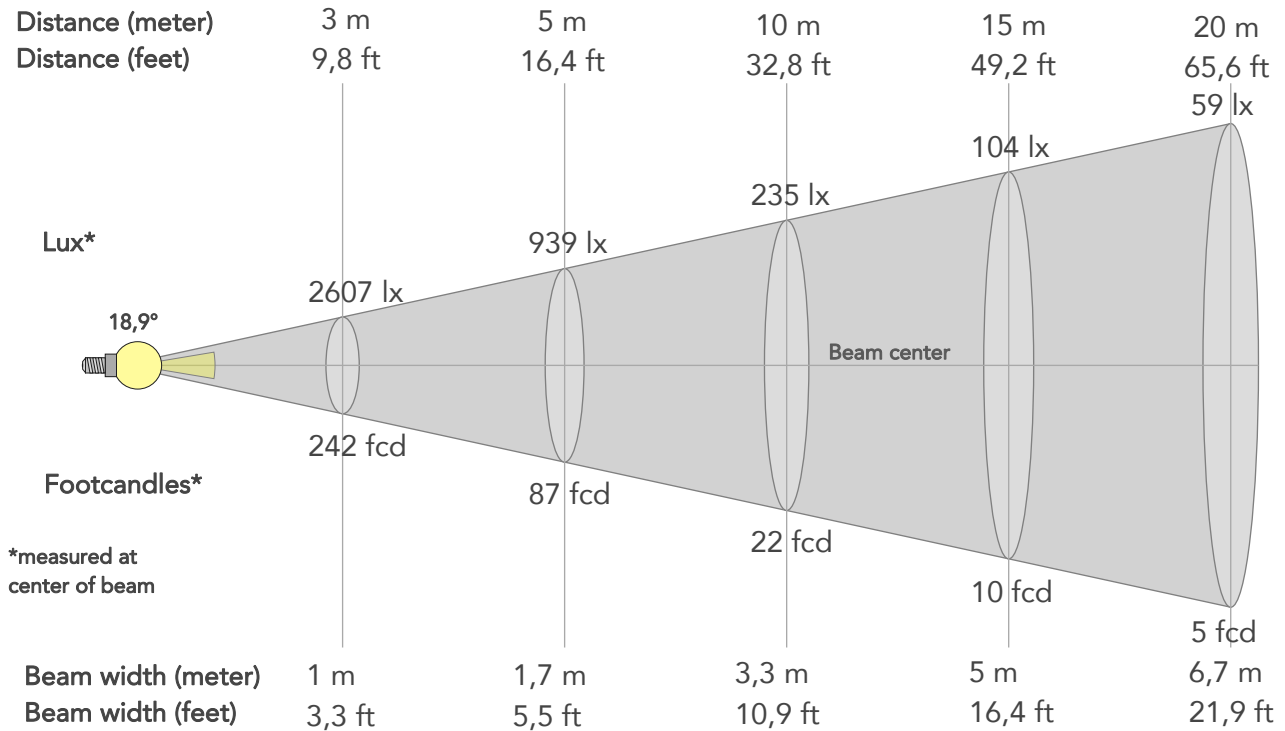

BEAM INTENSITIES AND WIDTHS

Distance	1m	2m	3m	4m	5m	7,5m	10m	15m	20m	25m	30m	40m	50m
Distance	3,3ft	6,6ft	9,8ft	13,1ft	16,4ft	24,6ft	32,8ft	49,2ft	65,6ft	82ft	98,4ft	131,2ft	164ft
Lux	23465lx	5866lx	2607lx	1467lx	939lx	417lx	235lx	104lx	59lx	38lx	26lx	15lx	9lx
Footcand.	2180fcd	545fcd	242fcd	136fcd	87fcd	39fcd	22fcd	10fcd	5fcd	3fcd	2fcd	1fcd	1fcd
Beam wid.	0,3m	0,7m	1m	1,3m	1,7m	2,5m	3,3m	5m	6,7m	8,3m	10m	13,3m	16,7m
Beam wid.	1,1ft	2,2ft	3,3ft	4,4ft	5,5ft	8,2ft	10,9ft	16,4ft	21,9ft	27,3ft	32,8ft	43,8ft	54,7ft

LINEAR DISTRIBUTION DIAGRAM

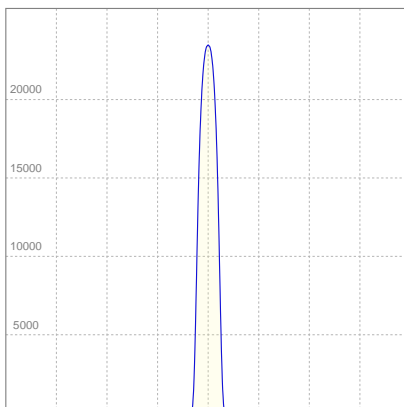

ELECTRICAL SPECIFICATIONS

Input voltage	Input current	Input power	Effeciency
223V	0,722A	141,7W	14lm/W

ISO CANDELA DIAGRAM

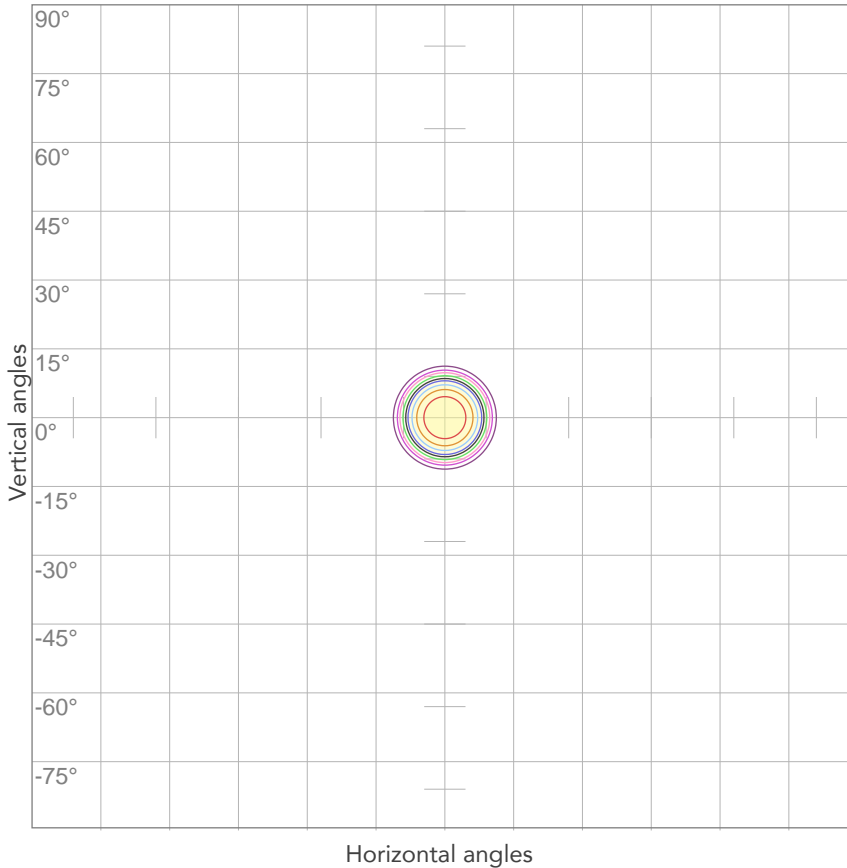

10%	2346 cd
20%	4693 cd
30%	7039 cd
40%	9386 cd
50%	11732 cd
60%	14079 cd
70%	16425 cd
80%	18772 cd

Conditions:

Number of c-planes: 2

Candela at center: 23465 cd

ISO LUX DIAGRAM

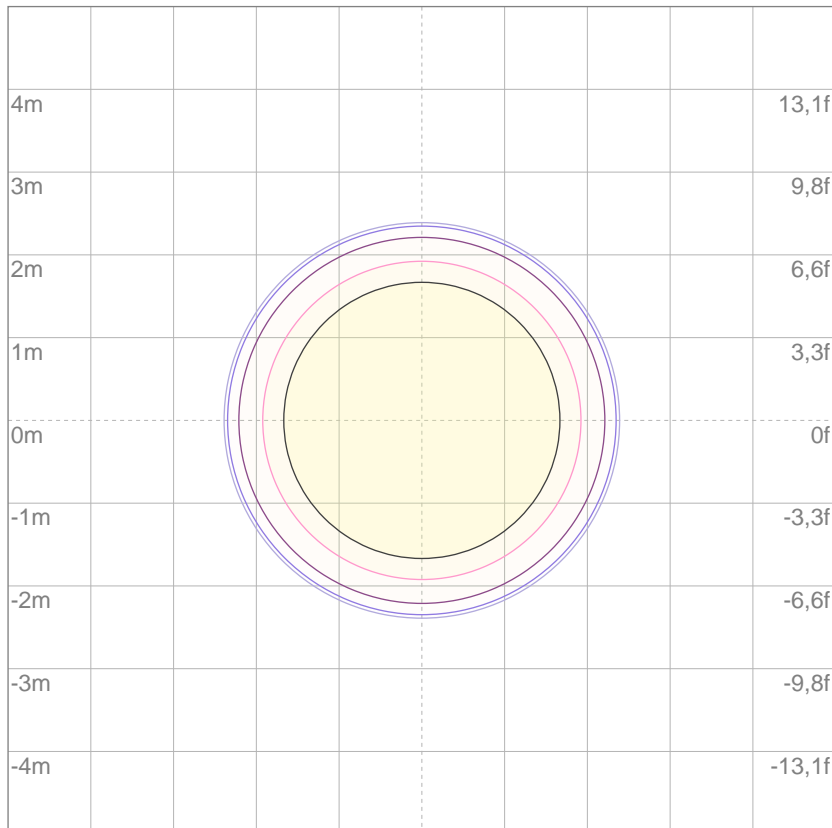

3%	7,04 lx
5%	11,7 lx
10%	23,5 lx
30%	70,4 lx
50%	117 lx

Conditions:

Number of c-planes: 2

Lux at center: 235 lx

Lux distribution on a surface when lamp is mounted at 10 meters from the surface.

Mounting height: 10 meters (33 feet)



Total lumen output:

1365 lm

Peak candela output:

295926 cd

Light quality:

CRI: 47,8

Color temperature:

3206 K

PRODUCT NAME:

ASTRAWASH7PIXIP

MEASUREMENT CONDITIONS:

Beam angle:

Min Zoom

Target:

3200K

Operator:

Paolo Carvone

Date and time:

16/02/2021 10:03:47

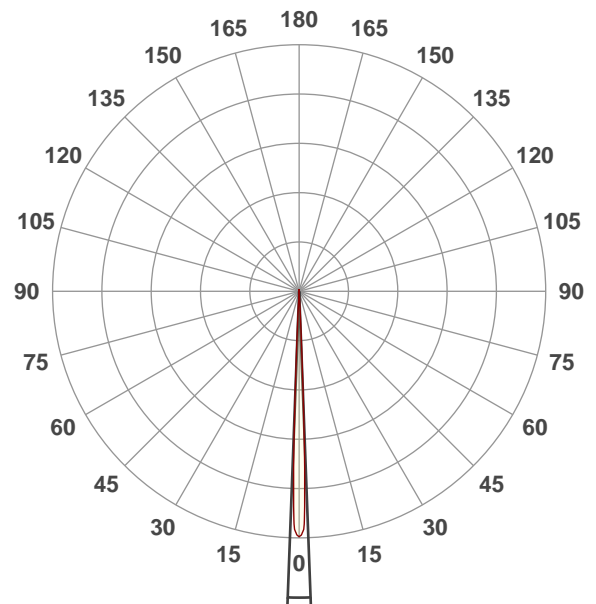

Beam angle 50%: 4,3°

Field angle 10%: 5,8°

Cut off angle 2.5%: 6,3°

Spectra

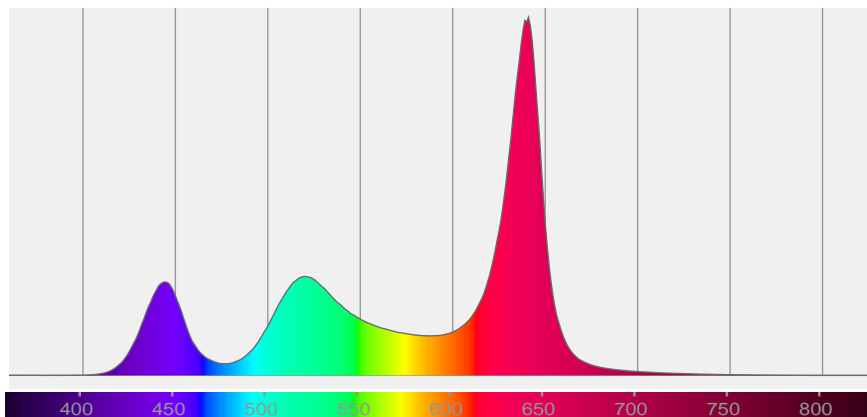

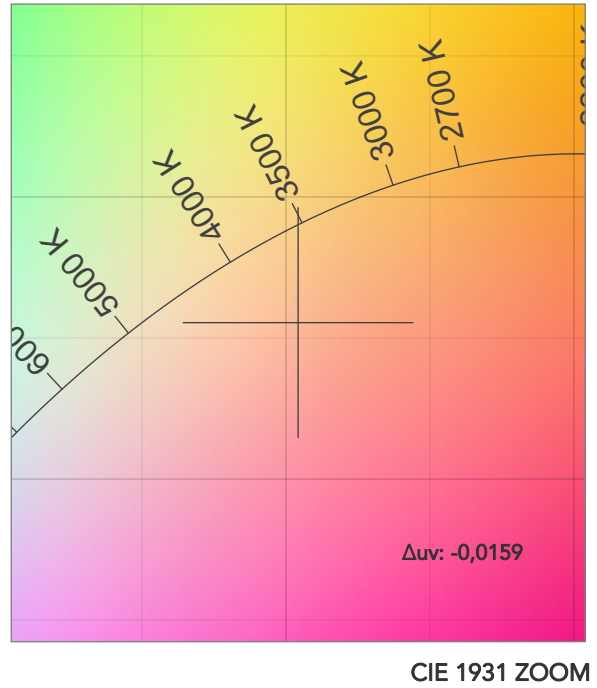
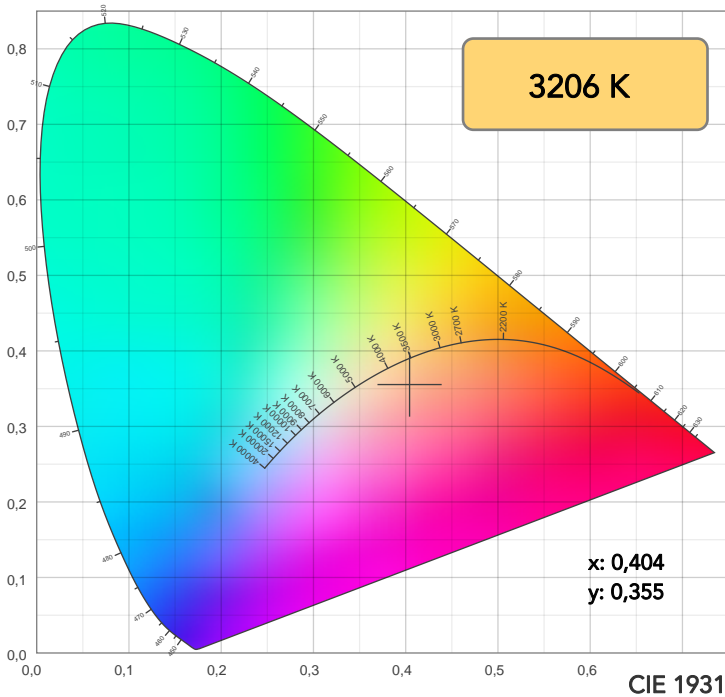

TM30: 68,0

CRI: 47,8 (R1-R8)

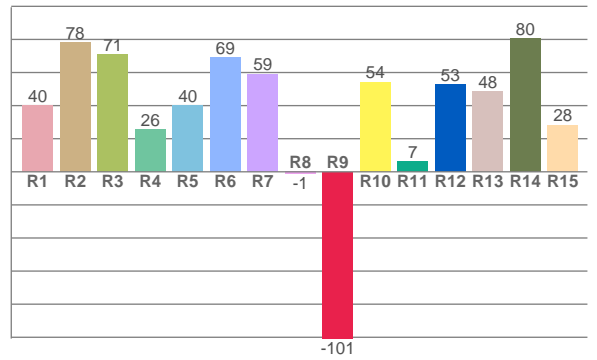
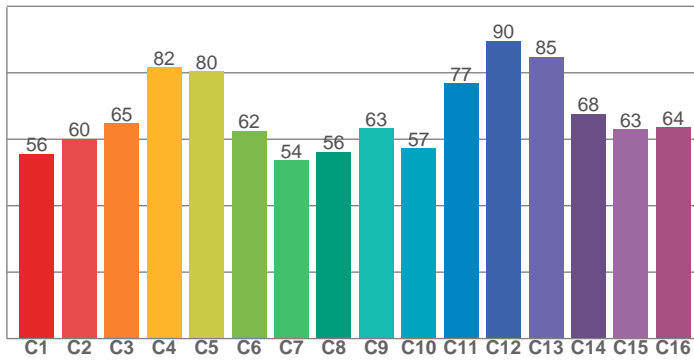

CRI R values, only R1-R8 are used to calculate final CRI value

R1	R2	R3	R4	R5	R6	R7	R8	R9	R10	R11	R12	R13	R14	R15
40,2	78,4	71,1	25,9	40,0	68,9	59,2	-1,3	-100,8	54,4	6,6	52,7	48,4	80,4	28,4

TM30 C values, 16 binned values out of total of 99 C values

C1	C2	C3	C4	C5	C6	C7	C8	C9	C10	C11	C12	C13	C14	C15	C16
55,6	60,1	64,8	81,7	80,4	62,4	53,6	56,3	63,3	57,2	76,8	89,6	84,7	67,7	62,9	63,5

CQS Q values

Q1	Q2	Q3	Q4	Q5	Q6	Q7	Q8	Q9	Q10	Q11	Q12	Q13	Q14	Q15
78,7	91,1	89,8	61,3	53,8	58,5	90,2	78,0	82,6	93,3	72,8	64,8	66,1	81,9	83,8

CQS: 73,2

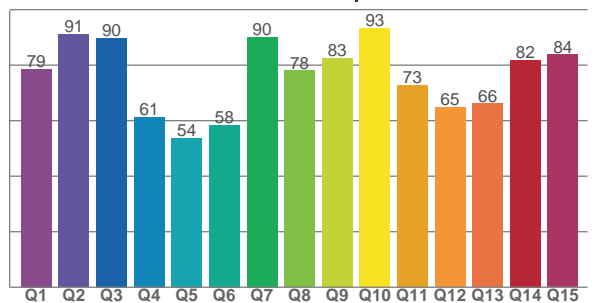

COLOR PARAMETERS

Color temperature	Color rendering index	Red component	Color fidelity	Color gamut	Color quality scale	Television lighting index	Color coordinate cie 1931	Color coordinate cie 1931	Color deviation from black body
CCT	CRI	CRI R9	TM30 Rf	TM30 Rg	CQS	TLCI	x	y	Δuv
3206 K	47,8	-100,8	68,0	127,6	73,2	33	0,404	0,355	-0,0159

TM30 DETAILS

Rf 68,0
Fidelity index Rf

Rg 127,6
Gammut index

Hue Bin	R _f	Graphic shifts (%)	
		Chroma	Hue
1	56	23%	-5%
2	60	18%	-13%
3	65	11%	-13%
4	82	7%	-3%
5	80	14%	7%
6	62	22%	13%
7	54	29%	4%
8	56	25%	-12%
9	63	18%	-19%
10	57	6%	-25%
11	77	-1%	-15%
12	90	-1%	-2%
13	85	4%	10%
14	68	5%	26%
15	63	17%	17%
16	64	27%	8%

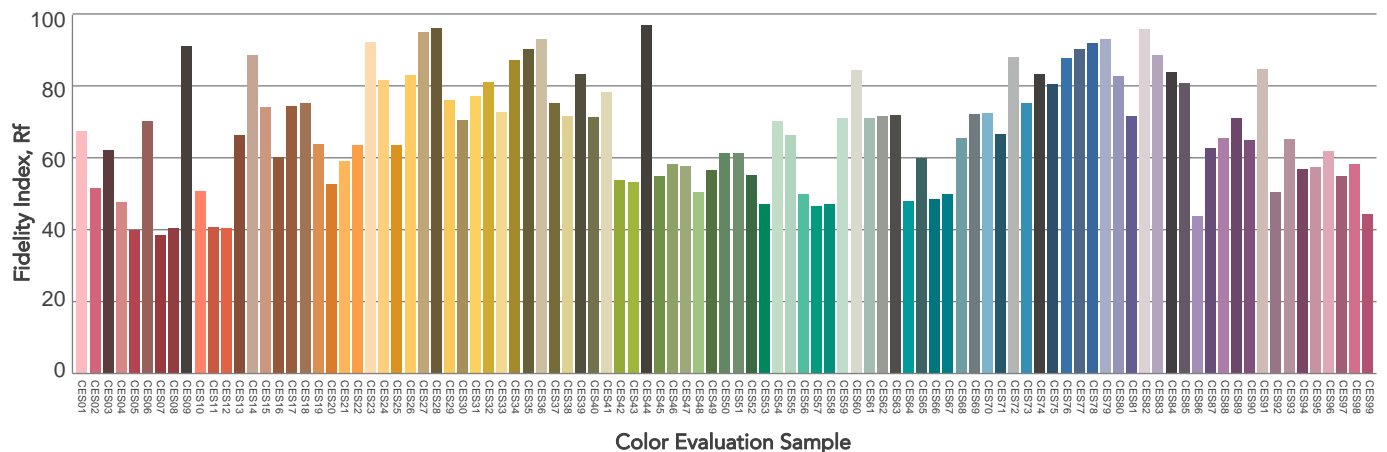
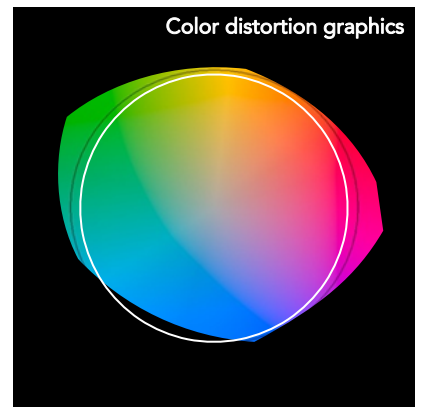
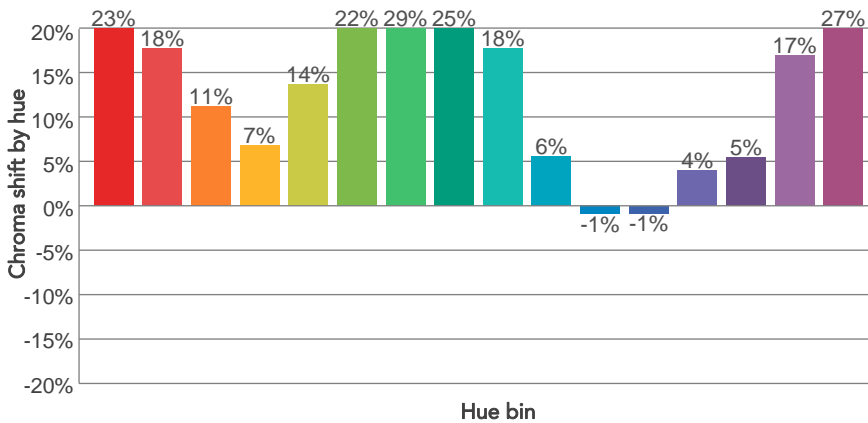
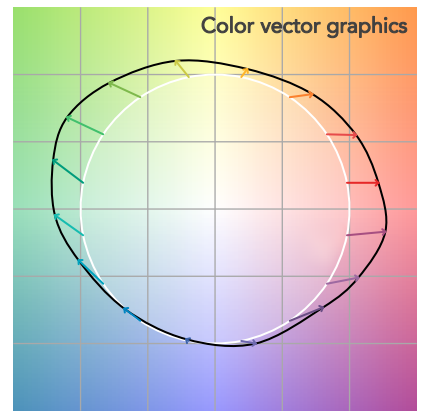
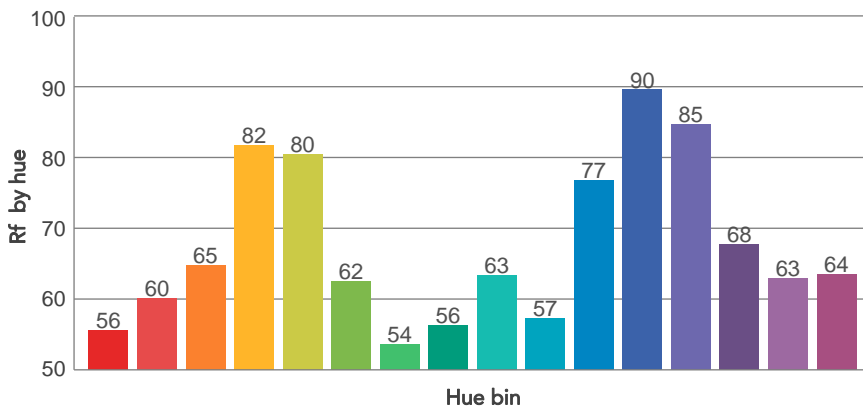
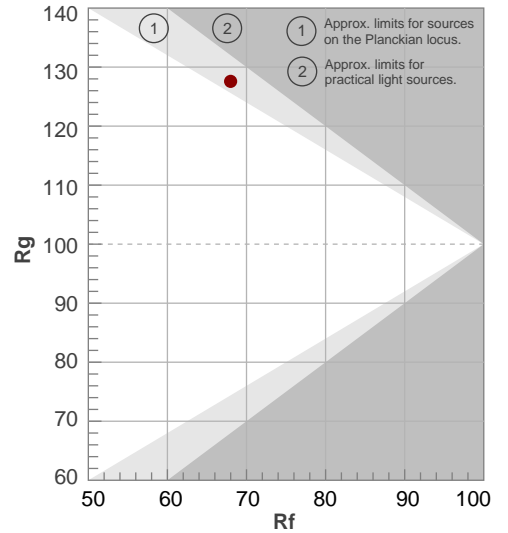

BEAM DETAILS



Beam angle 50%	Field angle 10%	Cut off angle 2,5%	Intensity ratio in 120° cone	Intensity ratio in 90° cone
4,3°	5,8°	6,3°	100,0%	100,0%

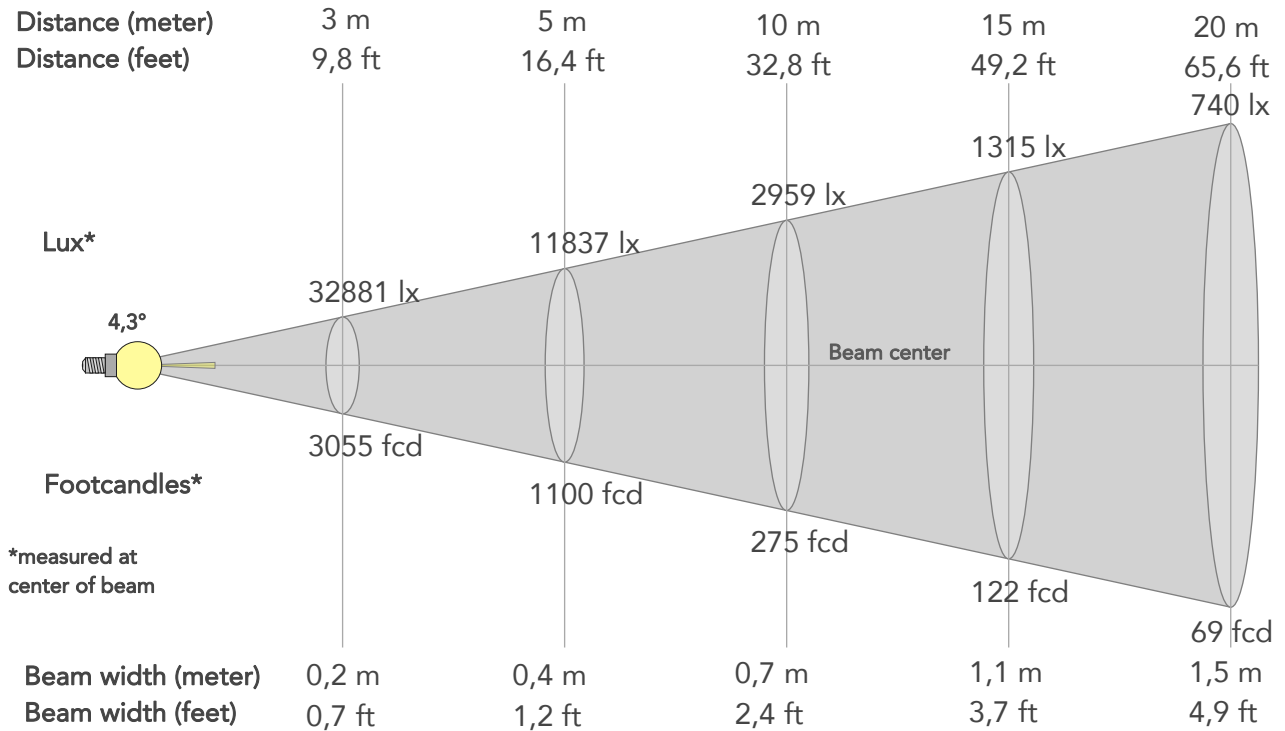

BEAM INTENSITIES AND WIDTHS

Distance	1m	2m	3m	4m	5m	7,5m	10m	15m	20m	25m	30m	40m	50m
Distance	3,3ft	6,6ft	9,8ft	13,1ft	16,4ft	24,6ft	32,8ft	49,2ft	65,6ft	82ft	98,4ft	131,2ft	164ft
Lux	295926lx	73981lx	32881lx	18495lx	11837lx	5261lx	2959lx	1315lx	740lx	473lx	329lx	185lx	118lx
Footcand.	27492fcd	6873fcd	3055fcd	1718fcd	1100fcd	489fcd	275fcd	122fcd	69fcd	44fcd	31fcd	17fcd	11fcd
Beam wid.	0,1m	0,1m	0,2m	0,3m	0,4m	0,6m	0,7m	1,1m	1,5m	1,9m	2,2m	3m	3,7m
Beam wid.	0,2ft	0,5ft	0,7ft	1ft	1,2ft	1,8ft	2,4ft	3,7ft	4,9ft	6,1ft	7,3ft	9,8ft	12,2ft

LINEAR DISTRIBUTION DIAGRAM

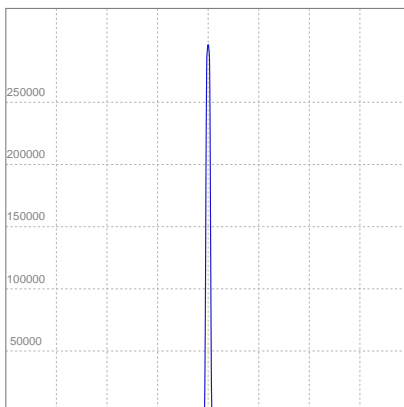

ELECTRICAL SPECIFICATIONS

Input voltage	Input current	Input power	Effeciency
223V	0,722A	141,6W	10lm/W

ISO CANDELA DIAGRAM

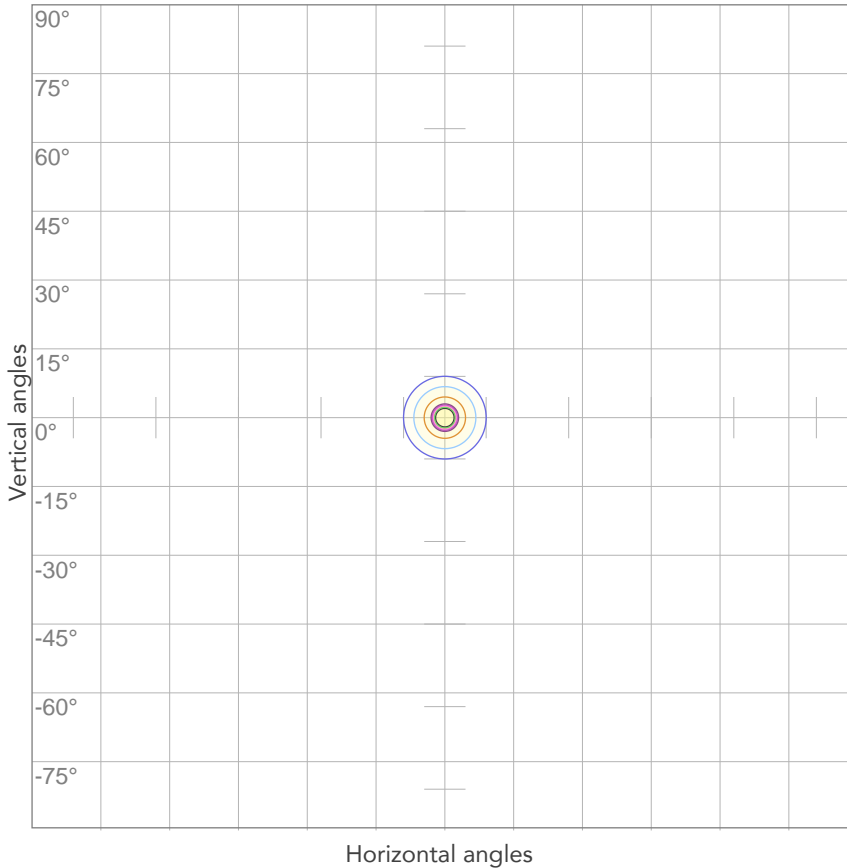

10%	29593 cd
20%	59185 cd
30%	88778 cd
40%	118370 cd
50%	147963 cd
60%	177555 cd
70%	207148 cd
80%	236741 cd

Conditions:

Number of c-planes: 2

Candela at center: 295926 cd

ISO LUX DIAGRAM

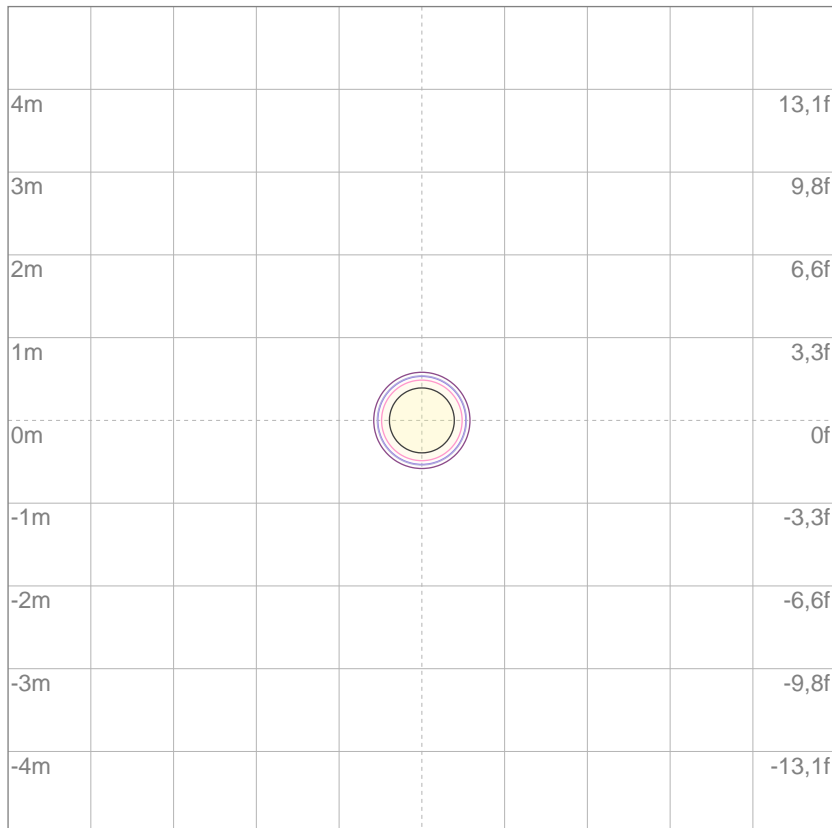

3%	88,8 lx
5%	148 lx
10%	296 lx
30%	888 lx
50%	1480 lx

Conditions:

Number of c-planes: 2

Lux at center: 2959 lx

Lux distribution on a surface when lamp is mounted at 10 meters from the surface.

Mounting height: 10 meters (33 feet)



Total lumen output:

3012 lm

Peak candela output:

7633 cd

Light quality:

CRI: 62,4

Color temperature:

4138 K

PRODUCT NAME:

ASTRAWASH7PIXIP

MEASUREMENT CONDITIONS:

Beam angle:

Max Zoom

Target:

4000K

Operator:

Paolo Carvone

Date and time:

16/02/2021 10:18:30

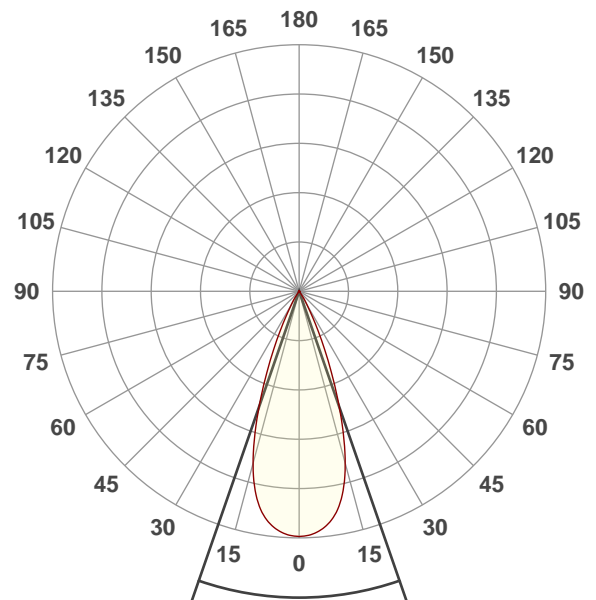

Beam angle 50%: 38,3°

Field angle 10%: 56,6°

Cut off angle 2.5%: 68°

Spectra

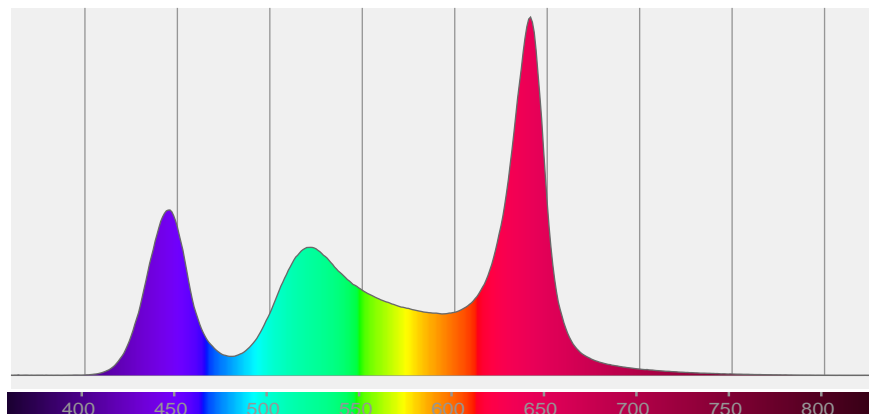

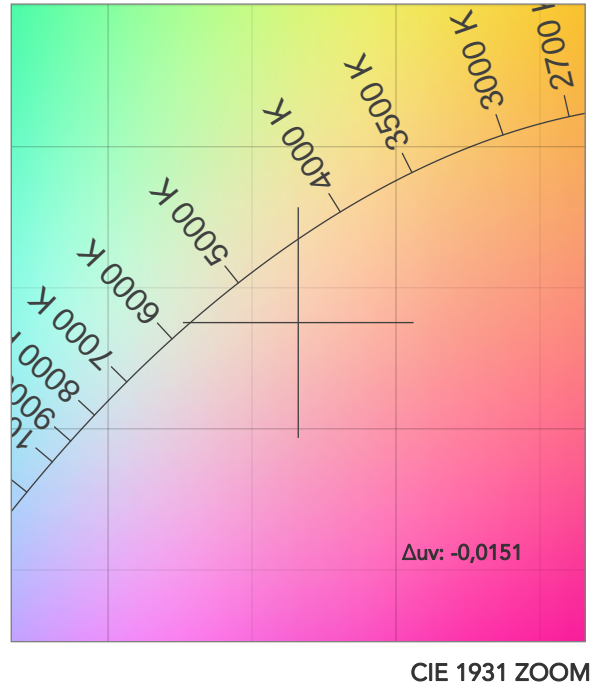
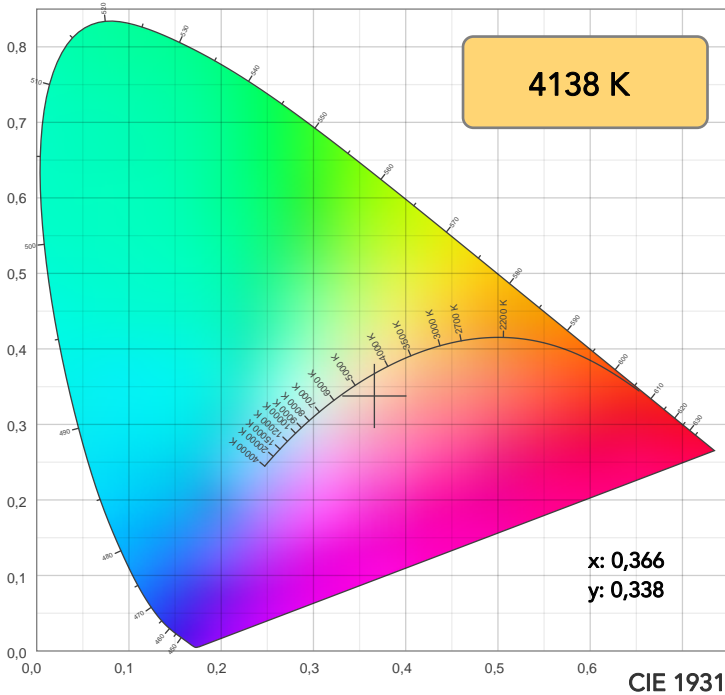

TM30: 75,5

CRI: 62,4 (R1-R8)

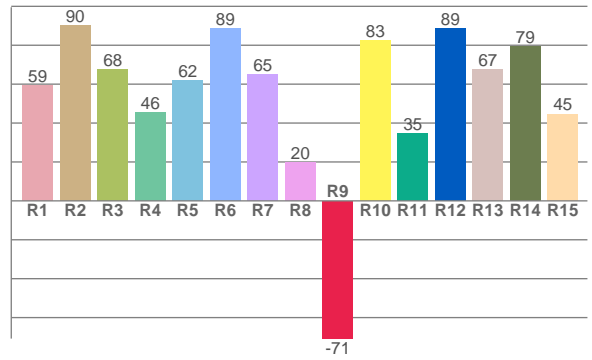
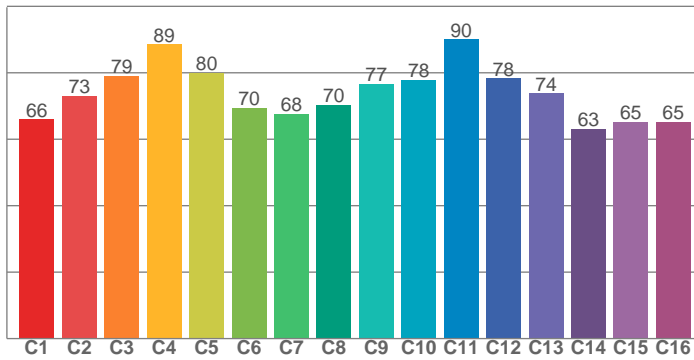

CRI R values, only R1-R8 are used to calculate final CRI value

R1	R2	R3	R4	R5	R6	R7	R8	R9	R10	R11	R12	R13	R14	R15
59,3	90,2	67,8	45,6	62,0	88,9	64,9	20,0	-70,8	82,6	34,6	88,8	67,5	79,3	44,7

TM30 C values, 16 binned values out of total of 99 C values

C1	C2	C3	C4	C5	C6	C7	C8	C9	C10	C11	C12	C13	C14	C15	C16
65,9	73,0	79,0	88,6	80,0	69,5	67,6	70,3	76,7	77,9	90,1	78,3	73,8	63,1	65,2	65,2

CQS Q values

Q1	Q2	Q3	Q4	Q5	Q6	Q7	Q8	Q9	Q10	Q11	Q12	Q13	Q14	Q15
81,7	89,3	89,7	84,3	71,2	71,6	94,1	82,2	79,6	95,1	88,3	79,2	77,0	86,7	87,9

CQS: 82,4

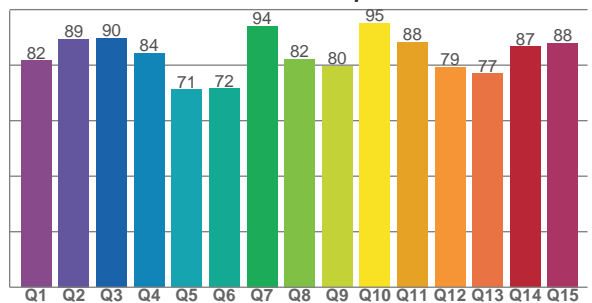

COLOR PARAMETERS

Color temperature	Color rendering index	Red component	Color fidelity	Color gamut	Color quality scale	Television lighting index	Color coordinate cie 1931	Color coordinate cie 1931	Color deviation from black body
CCT	CRI	CRI R9	TM30 Rf	TM30 Rg	CQS	TLCI	x	y	Δuv
4138 K	62,4	-70,8	75,5	123,4	82,4	52	0,366	0,338	-0,0151

TM30 DETAILS

Rf 75,5
Fidelity index Rf

Rg 123,4
Gammut index

Hue Bin	R _f	Graphic shifts (%)	
		Chroma	Hue
1	66	20%	-4%
2	73	12%	-9%
3	79	9%	-5%
4	89	5%	3%
5	80	11%	9%
6	70	19%	10%
7	68	22%	0%
8	70	17%	-7%
9	77	10%	-14%
10	78	2%	-13%
11	90	-2%	2%
12	78	1%	13%
13	74	3%	23%
14	63	10%	21%
15	65	19%	18%
16	65	23%	4%

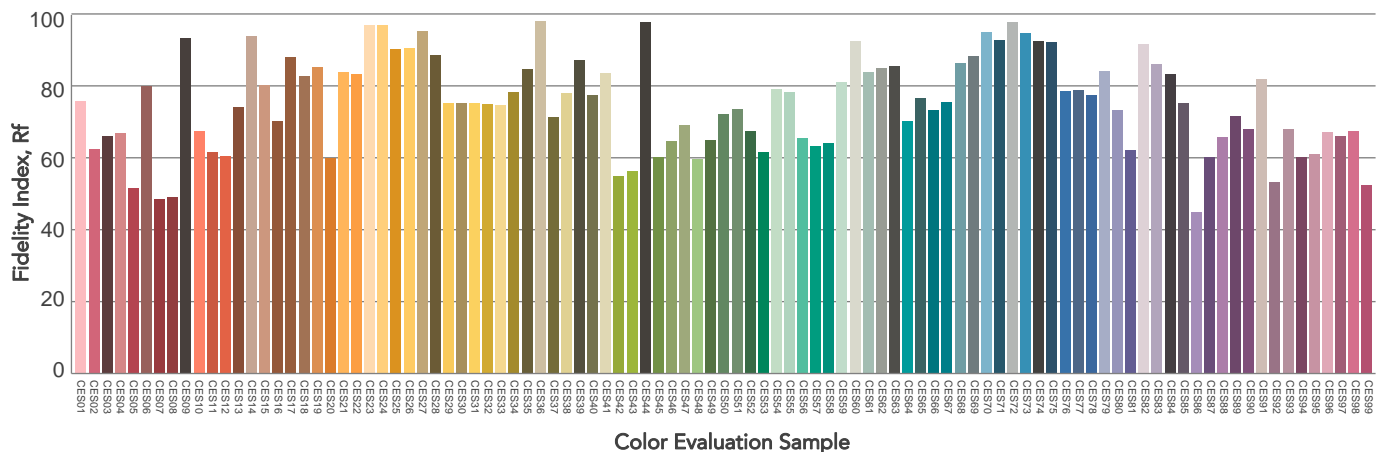
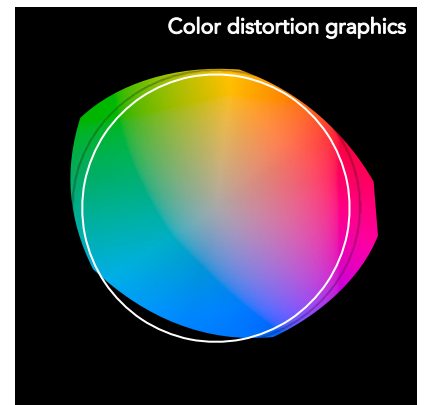
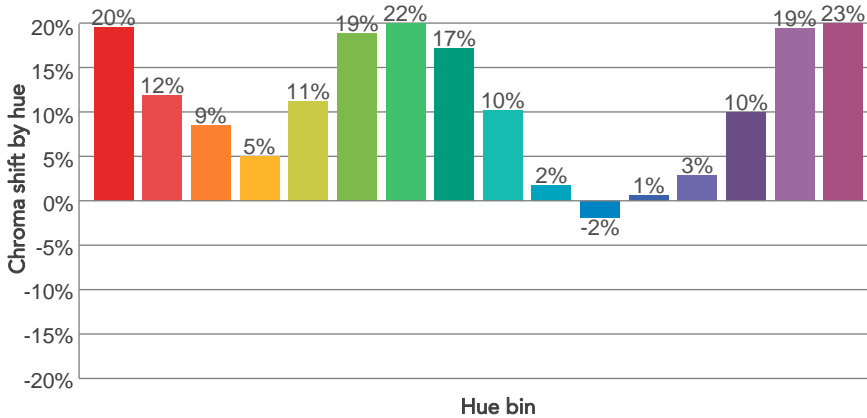
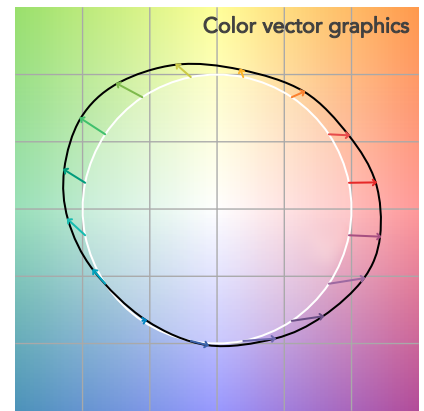
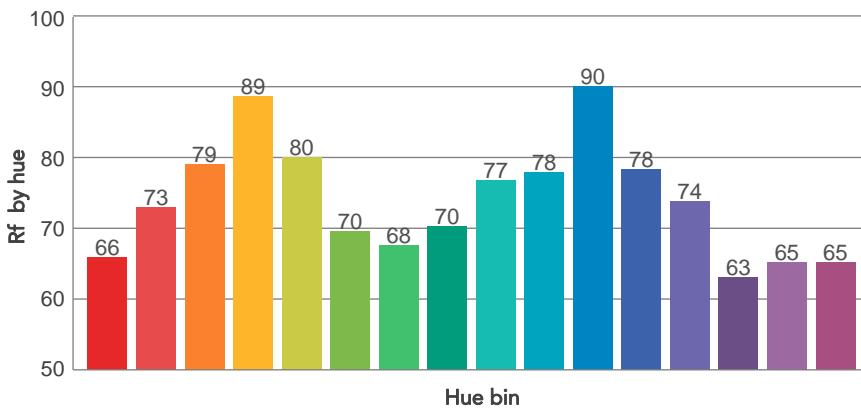
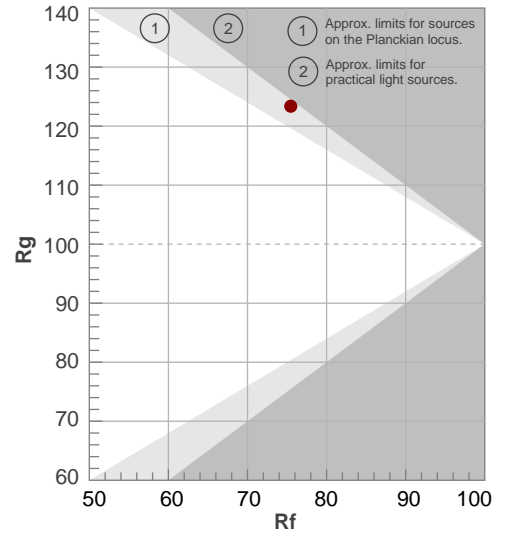

BEAM DETAILS



Beam angle 50%	Field angle 10%	Cut off angle 2,5%	Intensity ratio in 120° cone	Intensity ratio in 90° cone
38,3°	56,6°	68°	100,0%	100,0%

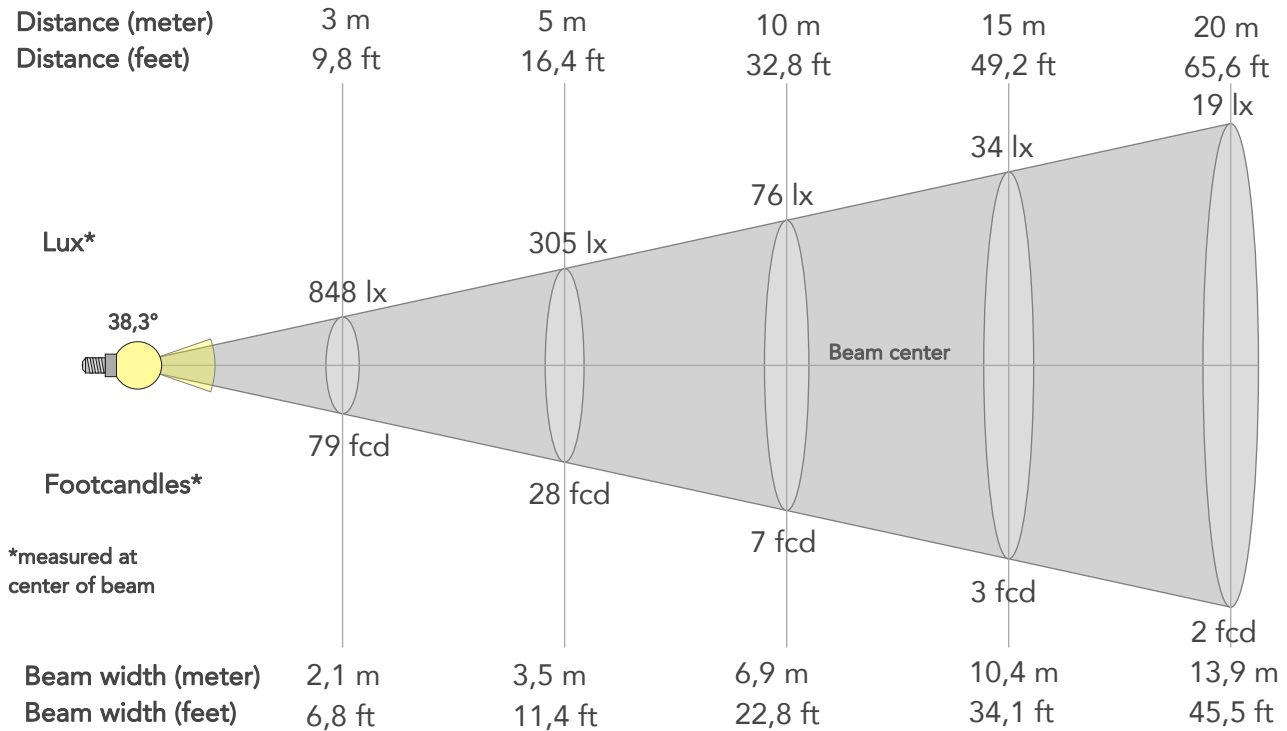

BEAM INTENSITIES AND WIDTHS

Distance	1m	2m	3m	4m	5m	7,5m	10m	15m	20m	25m	30m	40m	50m
Distance	3,3ft	6,6ft	9,8ft	13,1ft	16,4ft	24,6ft	32,8ft	49,2ft	65,6ft	82ft	98,4ft	131,2ft	164ft
Lux	7633lx	1908lx	848lx	477lx	305lx	136lx	76lx	34lx	19lx	12lx	8lx	5lx	3lx
Footcand.	709fcd	177fcd	79fcd	44fcd	28fcd	13fcd	7fcd	3fcd	2fcd	1fcd	1fcd	0fcd	0fcd
Beam wid.	0,7m	1,4m	2,1m	2,8m	3,5m	5,2m	6,9m	10,4m	13,9m	17,3m	20,8m	27,7m	34,7m
Beam wid.	2,3ft	4,6ft	6,8ft	9,1ft	11,4ft	17,1ft	22,8ft	34,1ft	45,5ft	56,9ft	68,3ft	91ft	113,8ft

LINEAR DISTRIBUTION DIAGRAM

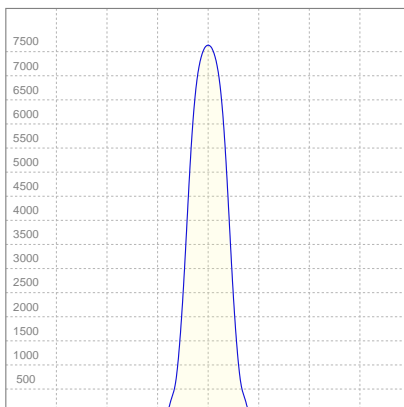

ELECTRICAL SPECIFICATIONS

Input voltage	Input current	Input power	Effeciency
223V	0,826A	165,5W	18lm/W

ISO CANDELA DIAGRAM

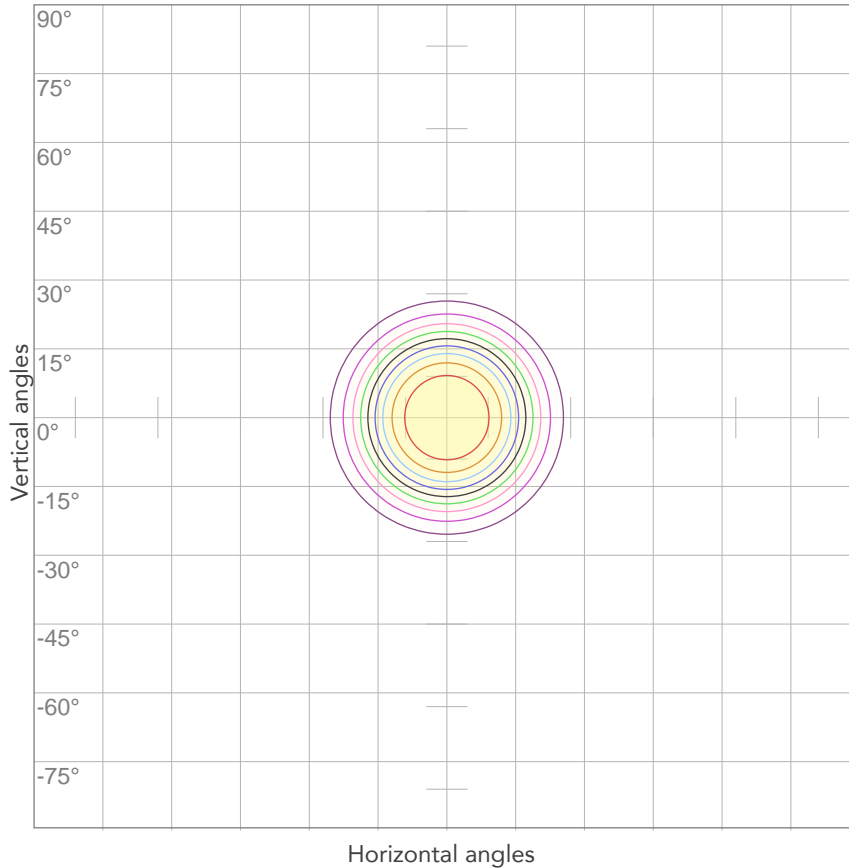

10%	763 cd
20%	1527 cd
30%	2290 cd
40%	3053 cd
50%	3816 cd
60%	4580 cd
70%	5343 cd
80%	6106 cd

Conditions:

Number of c-planes: 2

Candela at center: 7633 cd

ISO LUX DIAGRAM

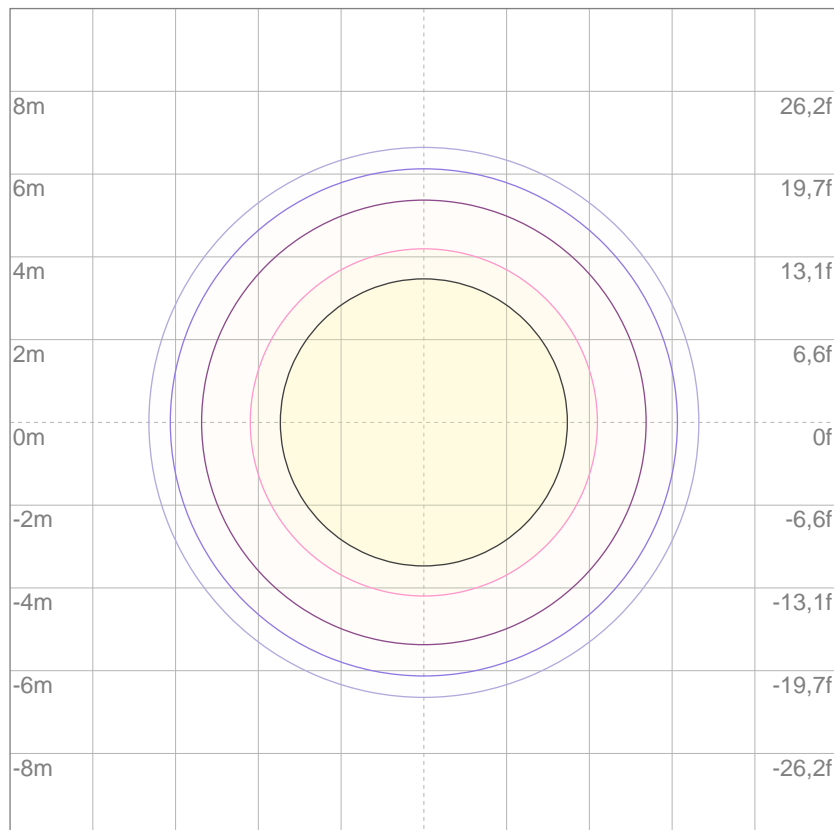

3%	2,29 lx
5%	3,82 lx
10%	7,63 lx
30%	22,9 lx
50%	38,2 lx

Conditions:

Number of c-planes: 2

Lux at center: 76,3 lx

Lux distribution on a surface when lamp is mounted at 10 meters from the surface.

Mounting height: 10 meters (33 feet)



Total lumen output:

2623 lm

Peak candela output:

30357 cd

Light quality:

CRI: 61,8

Color temperature:

4123 K

PRODUCT NAME:

ASTRAWASH7PIXIP

MEASUREMENT CONDITIONS:

Beam angle:

Med Zoom

Target:

4000K

Operator:

Paolo Carvone

Date and time:

16/02/2021 10:16:16

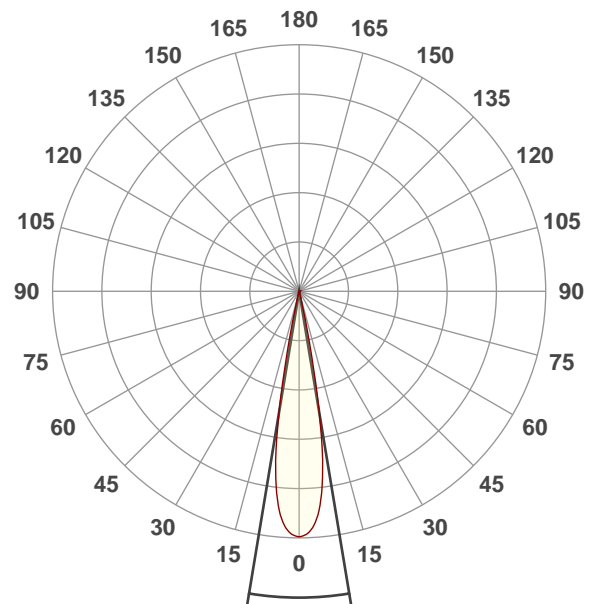

Beam angle 50%: 18,8°

Field angle 10%: 25,1°

Cut off angle 2.5%: 27,8°

Spectra

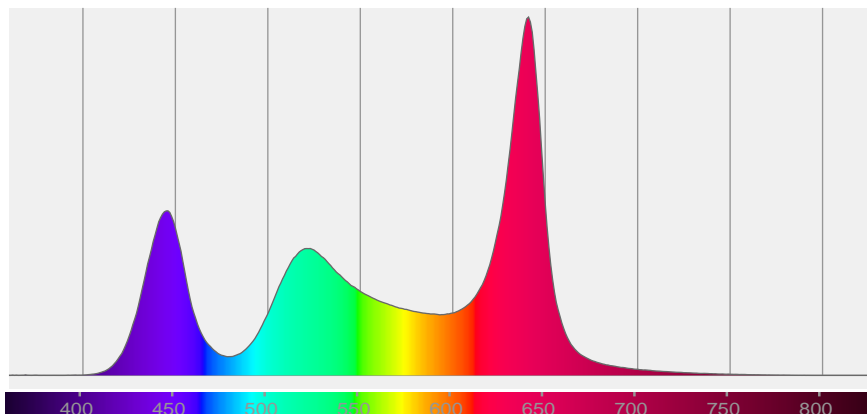

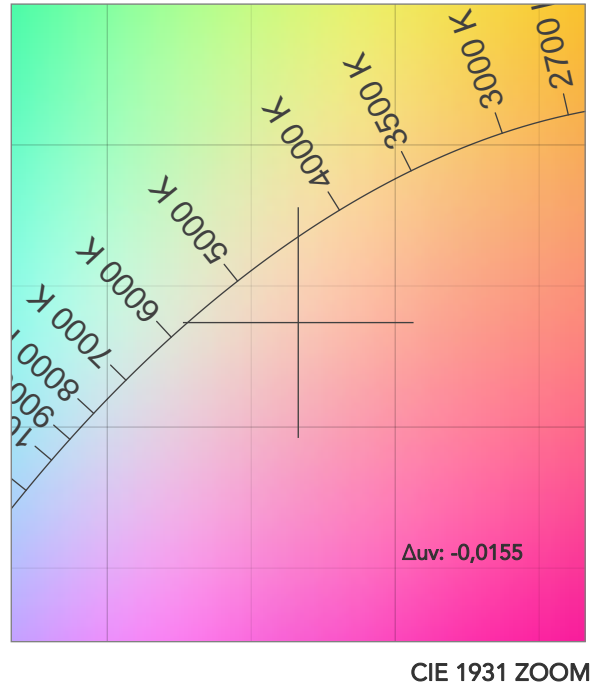
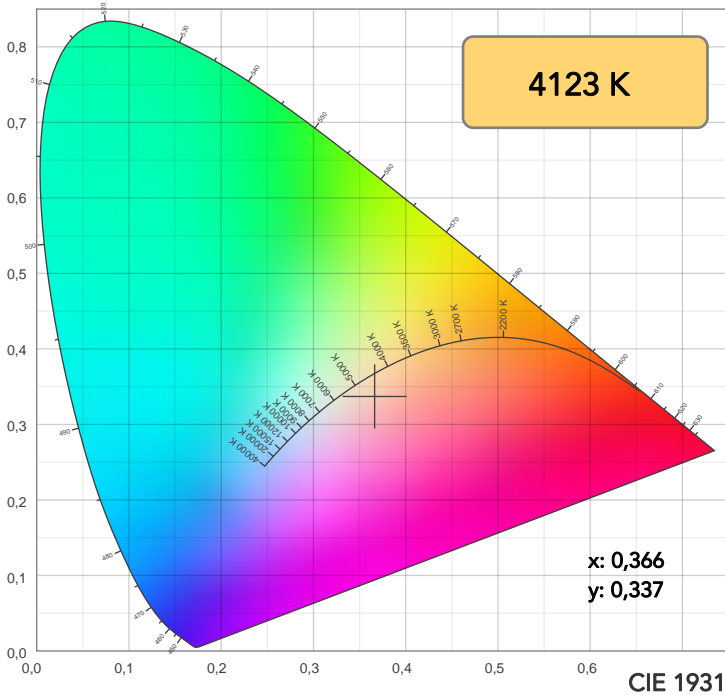

TM30: 75,2

CRI: 61,8 (R1-R8)

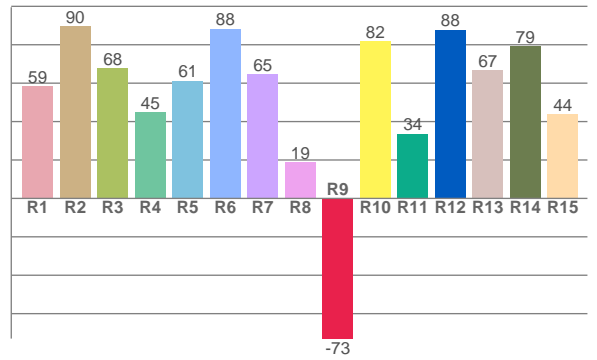
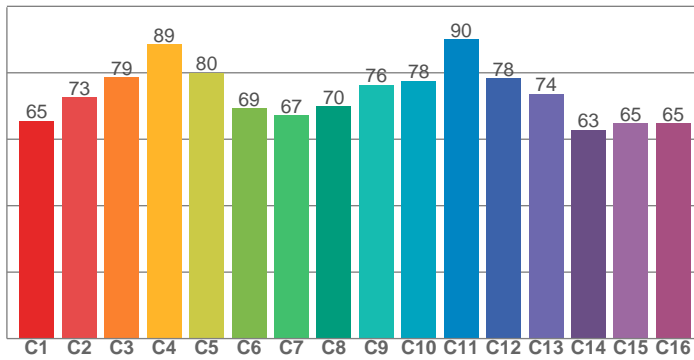

CRI R values, only R1-R8 are used to calculate final CRI value

R1	R2	R3	R4	R5	R6	R7	R8	R9	R10	R11	R12	R13	R14	R15
58,5	89,8	67,7	44,9	61,2	88,3	64,7	18,9	-73,0	81,7	33,6	87,8	66,7	79,2	43,7

TM30 C values, 16 binned values out of total of 99 C values

C1	C2	C3	C4	C5	C6	C7	C8	C9	C10	C11	C12	C13	C14	C15	C16
65,5	72,5	78,6	88,5	80,0	69,3	67,2	69,9	76,4	77,5	90,0	78,3	73,6	62,8	64,8	64,8

CQS Q values

Q1	Q2	Q3	Q4	Q5	Q6	Q7	Q8	Q9	Q10	Q11	Q12	Q13	Q14	Q15
81,5	89,2	89,8	83,9	70,8	71,3	94,2	82,0	79,4	95,2	88,0	78,9	76,8	86,6	87,7

CQS: 82,2

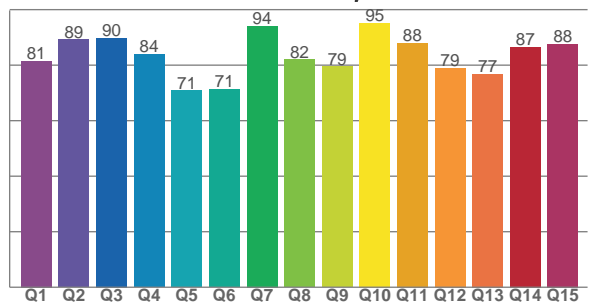

COLOR PARAMETERS

Color temperature	Color rendering index	Red component	Color fidelity	Color gamut	Color quality scale	Television lighting index	Color coordinate cie 1931	Color coordinate cie 1931	Color deviation from black body
CCT	CRI	CRI R9	TM30 Rf	TM30 Rg	CQS	TLCI	x	y	Δuv
4123 K	61,8	-73,0	75,2	123,6	82,2	51	0,366	0,337	-0,0155

TM30 DETAILS

Rf 75,2
Fidelity index Rf

Rg 123,6
Gammut index

Hue Bin	R _f	Graphic shifts (%)	
		Chroma	Hue
1	65	20%	-4%
2	73	12%	-9%
3	79	9%	-6%
4	89	5%	3%
5	80	11%	9%
6	69	19%	10%
7	67	22%	0%
8	70	17%	-6%
9	76	10%	-14%
10	78	2%	-13%
11	90	-2%	2%
12	78	1%	13%
13	74	3%	23%
14	63	10%	21%
15	65	20%	18%
16	65	23%	4%

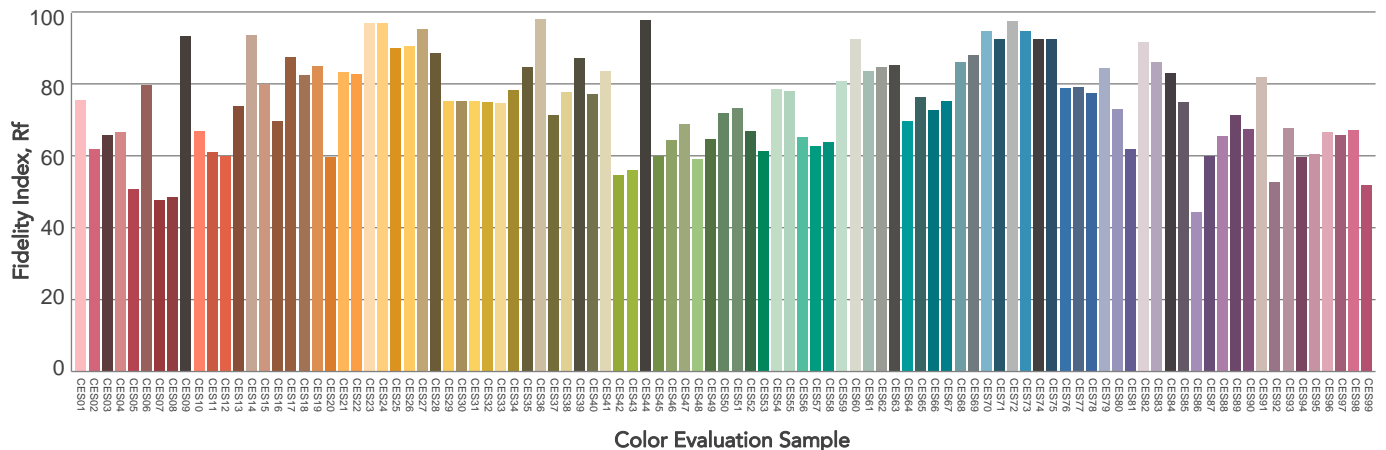
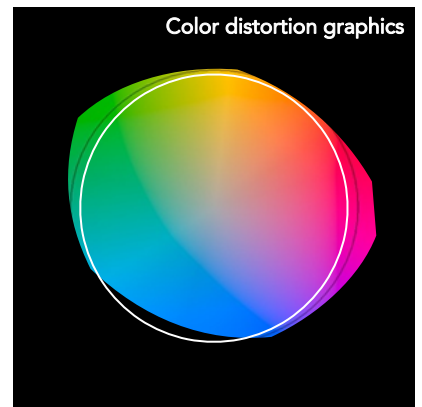
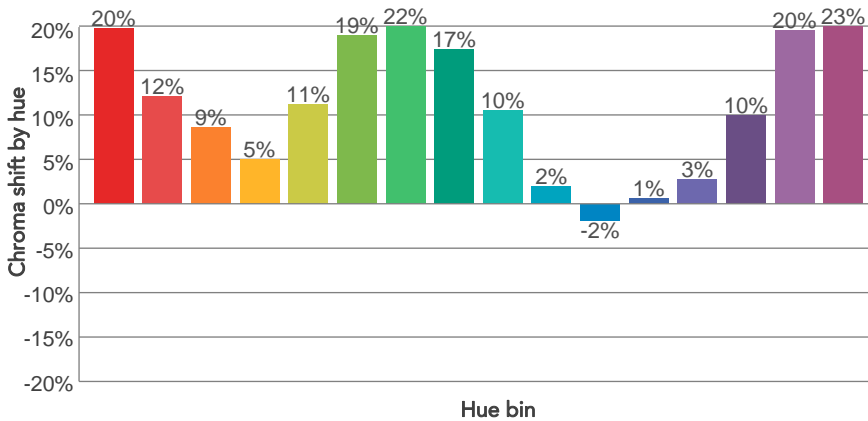
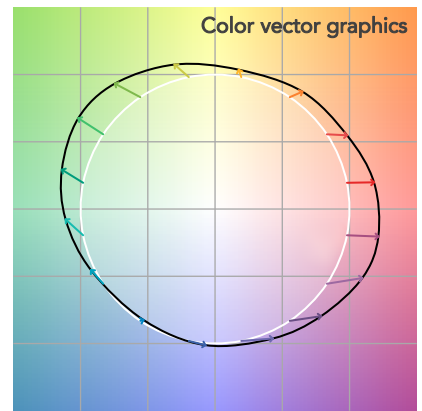
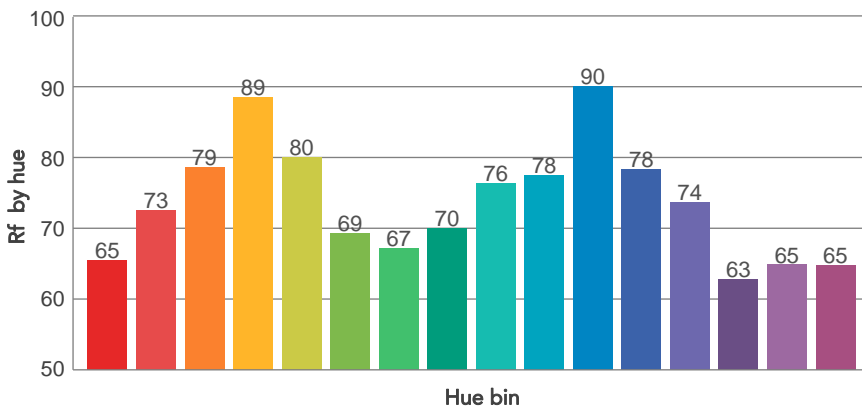
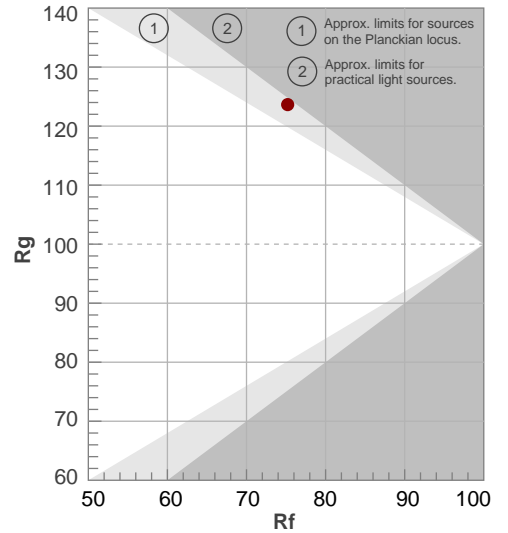

BEAM DETAILS



Beam angle 50%	Field angle 10%	Cut off angle 2,5%	Intensity ratio in 120° cone	Intensity ratio in 90° cone
18,8°	25,1°	27,8°	100,0%	100,0%

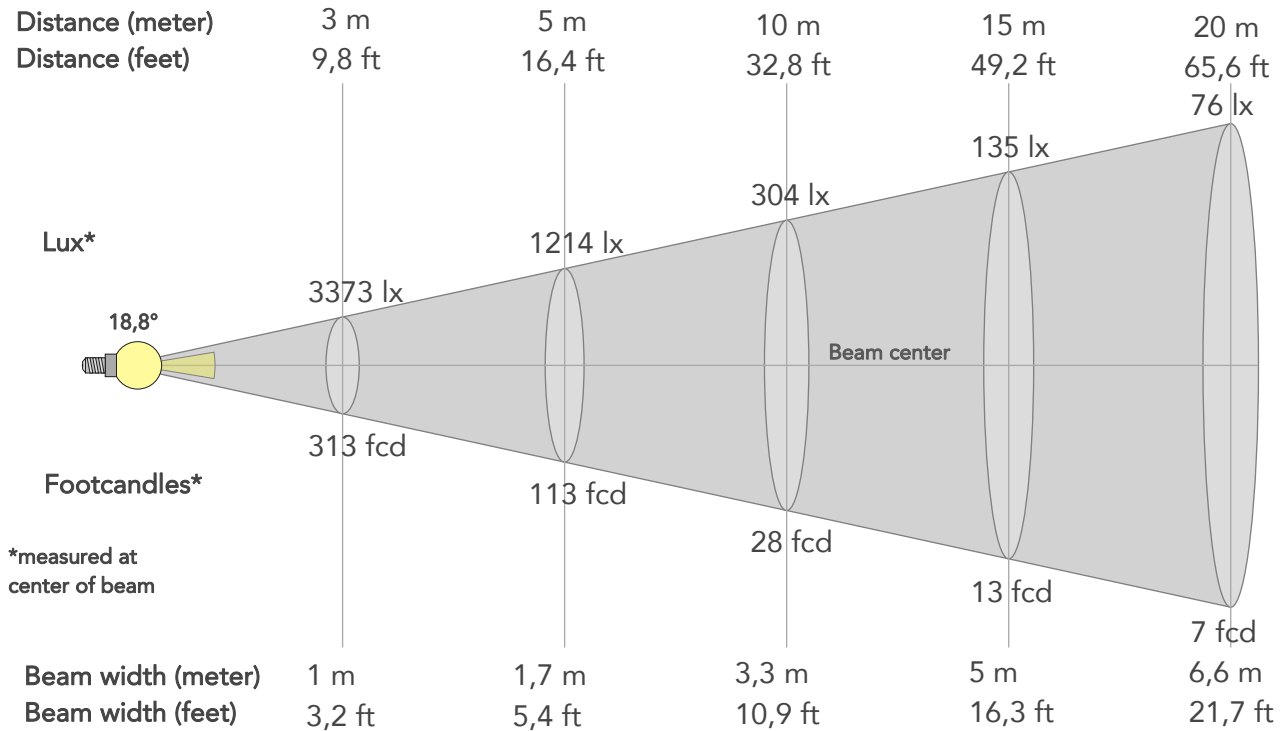

BEAM INTENSITIES AND WIDTHS

Distance	1m	2m	3m	4m	5m	7,5m	10m	15m	20m	25m	30m	40m	50m
Distance	3,3ft	6,6ft	9,8ft	13,1ft	16,4ft	24,6ft	32,8ft	49,2ft	65,6ft	82ft	98,4ft	131,2ft	164ft
Lux	30357lx	7589lx	3373lx	1897lx	1214lx	540lx	304lx	135lx	76lx	49lx	34lx	19lx	12lx
Footcand.	2820fcd	705fcd	313fcd	176fcd	113fcd	50fcd	28fcd	13fcd	7fcd	5fcd	3fcd	2fcd	1fcd
Beam wid.	0,3m	0,7m	1m	1,3m	1,7m	2,5m	3,3m	5m	6,6m	8,3m	9,9m	13,3m	16,6m
Beam wid.	1,1ft	2,2ft	3,2ft	4,3ft	5,4ft	8,2ft	10,9ft	16,3ft	21,7ft	27,2ft	32,6ft	43,5ft	54,4ft

LINEAR DISTRIBUTION DIAGRAM

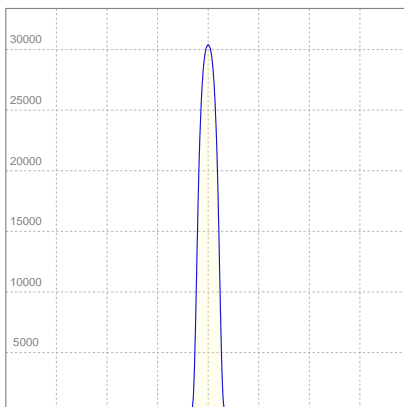

ELECTRICAL SPECIFICATIONS

Input voltage	Input current	Input power	Effeciency
223V	0,825A	165,2W	16lm/W

ISO CANDELA DIAGRAM

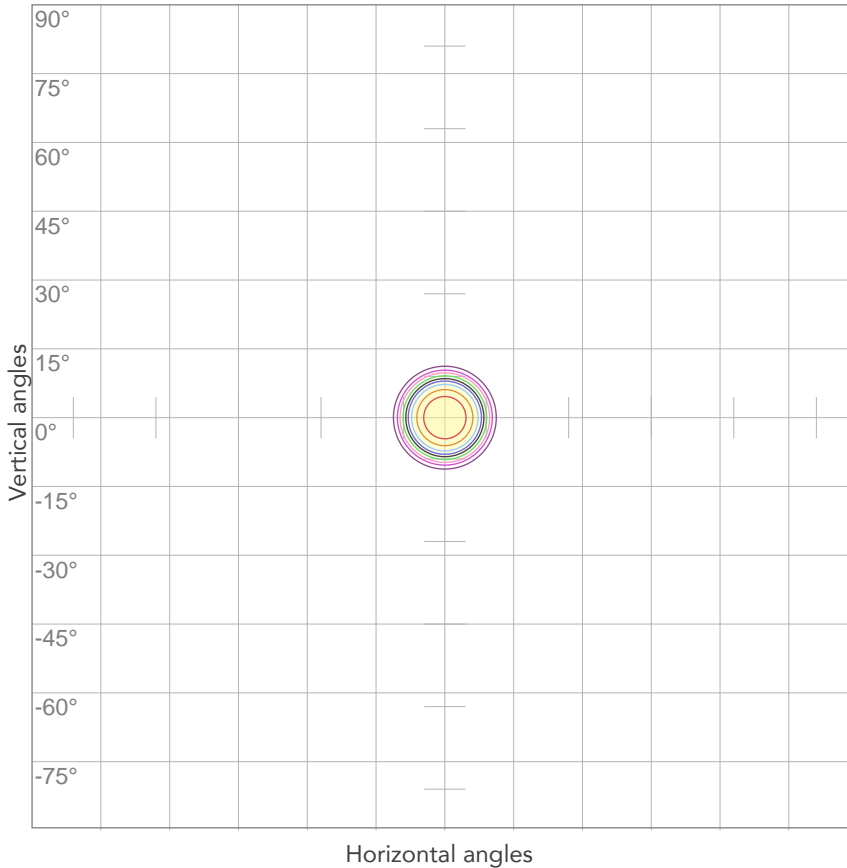

10%	3036 cd
20%	6071 cd
30%	9107 cd
40%	12143 cd
50%	15178 cd
60%	18214 cd
70%	21250 cd
80%	24285 cd

Conditions:

Number of c-planes: 2

Candela at center: 30357 cd

ISO LUX DIAGRAM

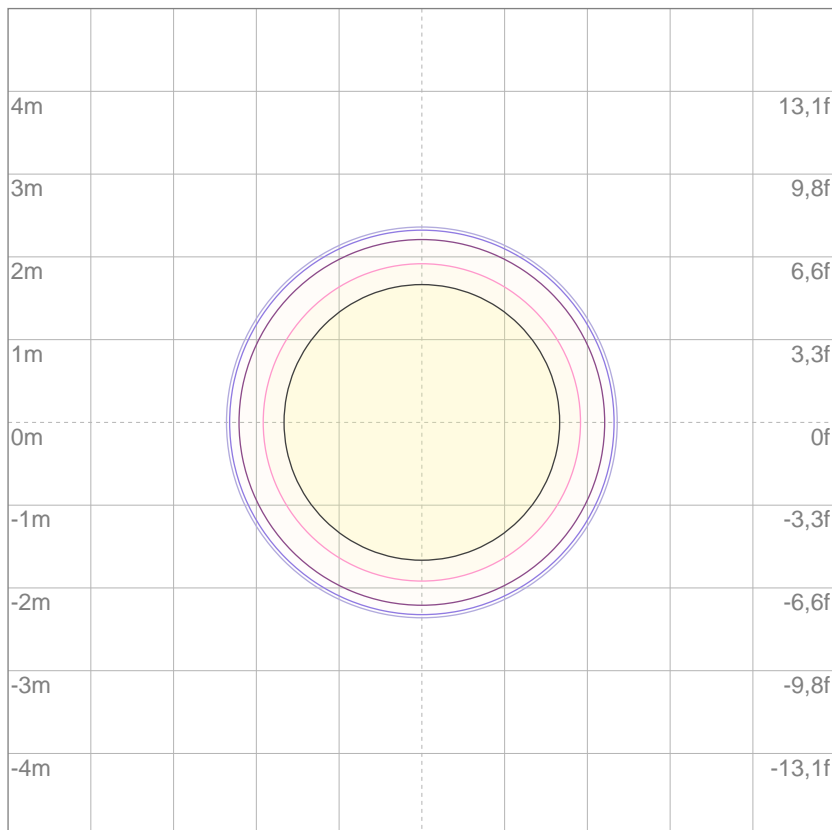

Mounting height: 10 meters (33 feet)

3%	9,11 lx
5%	15,2 lx
10%	30,4 lx
30%	91,1 lx
50%	152 lx

Conditions:

Number of c-planes: 2

Lux at center: 304 lx

Lux distribution on a surface when lamp is mounted at 10 meters from the surface.



Total lumen output:

1721 lm

Peak candela output:

383093 cd

Light quality:

CRI: 60,4

Color temperature:

4050 K

PRODUCT NAME:

ASTRAWASH7PIXIP

MEASUREMENT CONDITIONS:

Beam angle:

Min Zoom

Target:

4000K

Operator:

Paolo Carvone

Date and time:

16/02/2021 10:14:28

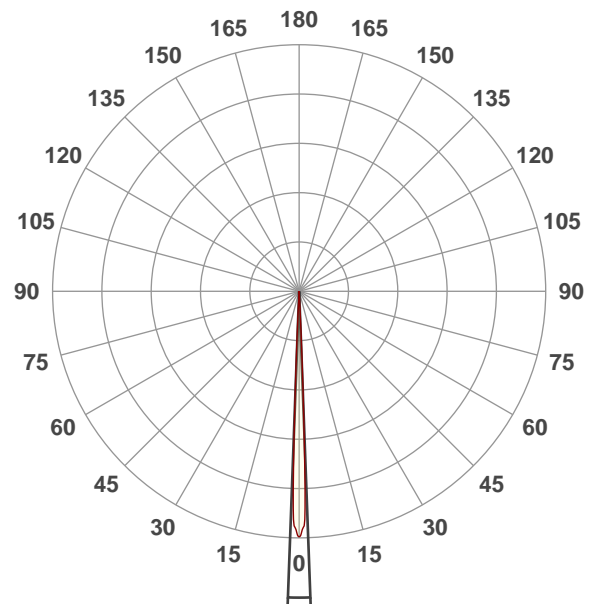

Beam angle 50%: 4,2°

Field angle 10%: 5,6°

Cut off angle 2.5%: 6,1°

Spectra

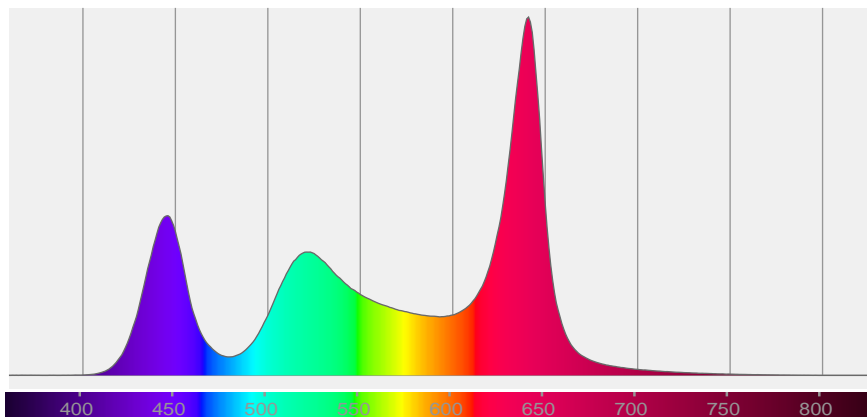

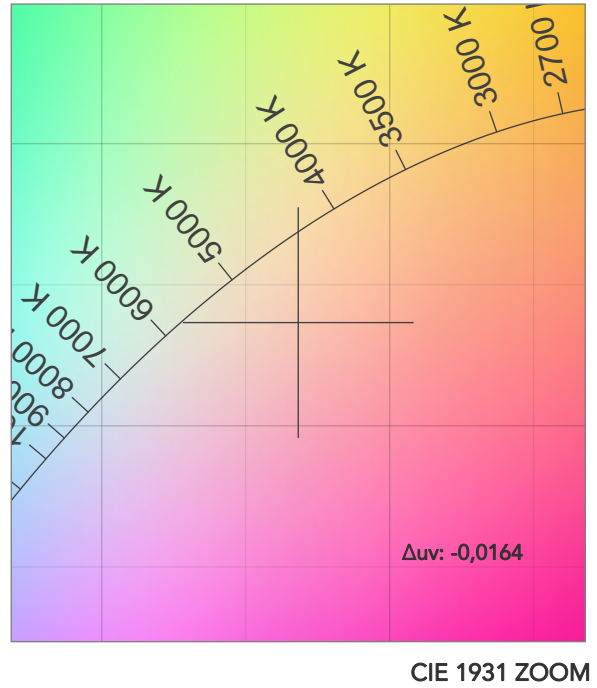
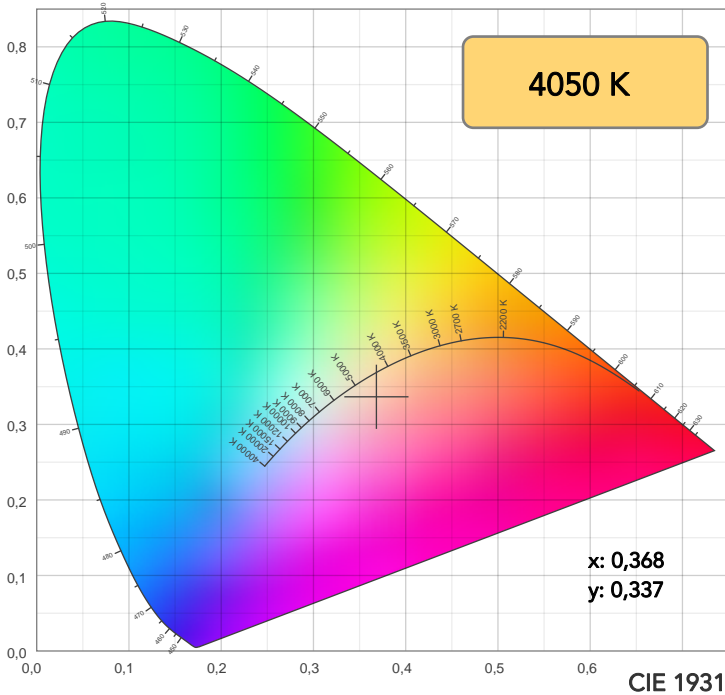

TM30: 74,8

CRI: 60,4 (R1-R8)

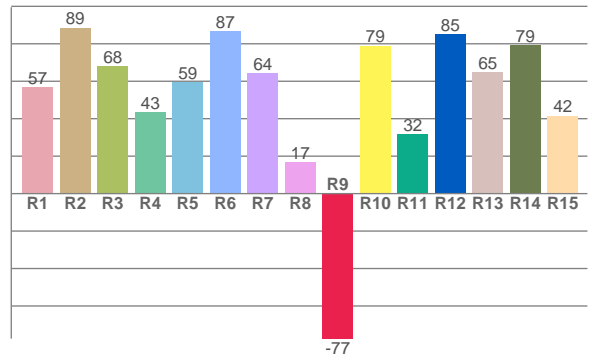
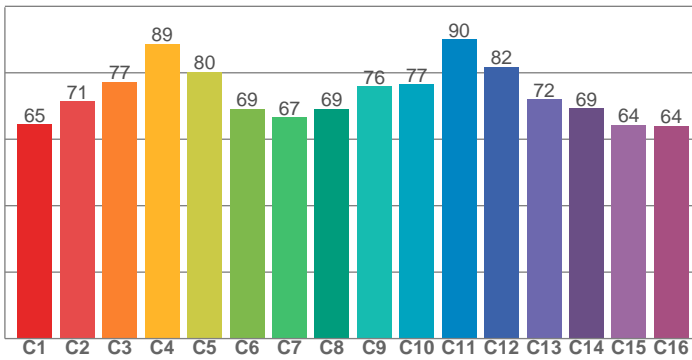

CRI R values, only R1-R8 are used to calculate final CRI value

R1	R2	R3	R4	R5	R6	R7	R8	R9	R10	R11	R12	R13	R14	R15
56,7	88,6	68,0	43,3	59,3	86,5	64,2	16,6	-77,4	78,9	31,5	85,2	64,8	79,3	41,6

TM30 C values, 16 binned values out of total of 99 C values

C1	C2	C3	C4	C5	C6	C7	C8	C9	C10	C11	C12	C13	C14	C15	C16
64,5	71,4	77,3	88,7	80,3	69,1	66,6	69,2	75,8	76,5	90,0	81,7	72,0	69,3	64,3	64,1

CQS Q values

Q1	Q2	Q3	Q4	Q5	Q6	Q7	Q8	Q9	Q10	Q11	Q12	Q13	Q14	Q15
80,9	89,2	90,4	82,9	70,0	70,7	94,1	81,6	79,4	95,7	87,2	78,2	76,2	86,1	87,2

CQS: 81,7

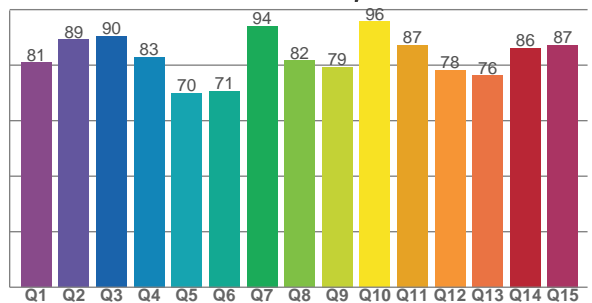

COLOR PARAMETERS

Color temperature	Color rendering index	Red component	Color fidelity	Color gamut	Color quality scale	Television lighting index	Color coordinate cie 1931	Color coordinate cie 1931	Color deviation from black body
CCT	CRI	CRI R9	TM30 Rf	TM30 Rg	CQS	TLCI	x	y	Δuv
4050 K	60,4	-77,4	74,8	124,3	81,7	50	0,368	0,337	-0,0164

TM30 DETAILS

Rf 74,8
Fidelity index Rf

Rg 124,3
Gammut index

Hue Bin	R _f	Graphic shifts (%)	
		Chroma	Hue
1	65	20%	-4%
2	71	13%	-9%
3	77	9%	-6%
4	89	5%	2%
5	80	11%	8%
6	69	19%	10%
7	67	22%	1%
8	69	18%	-6%
9	76	11%	-14%
10	77	2%	-14%
11	90	-2%	1%
12	82	2%	10%
13	72	4%	21%
14	69	9%	23%
15	64	20%	19%
16	64	23%	4%

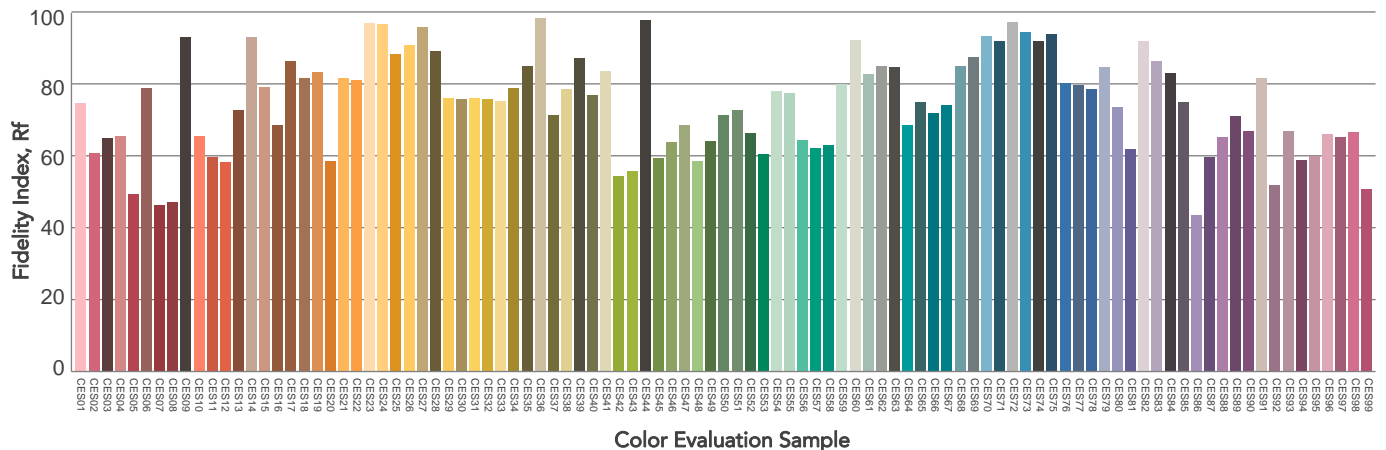
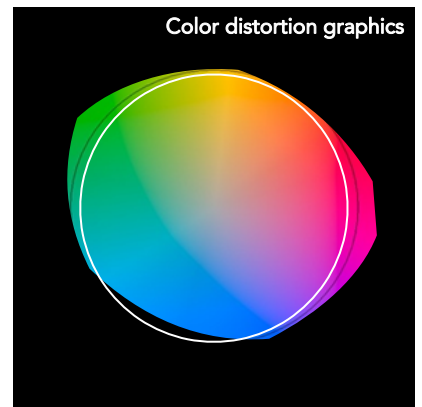
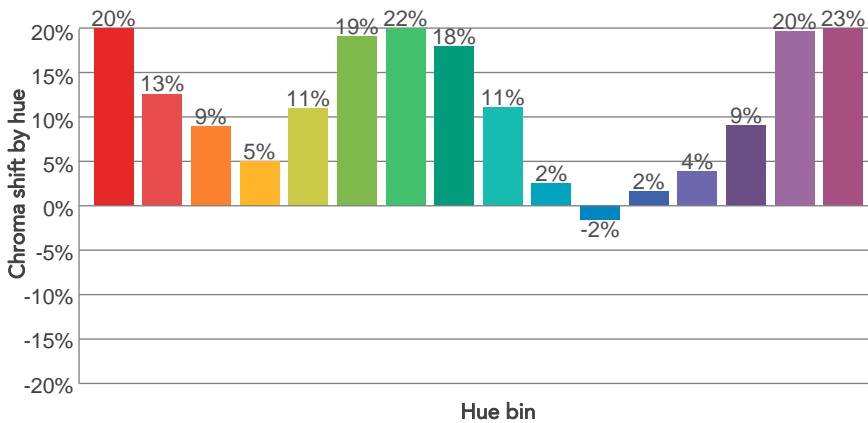
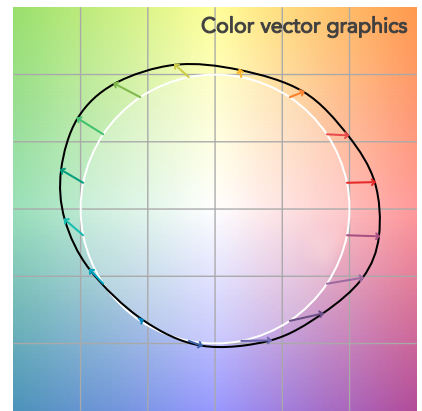
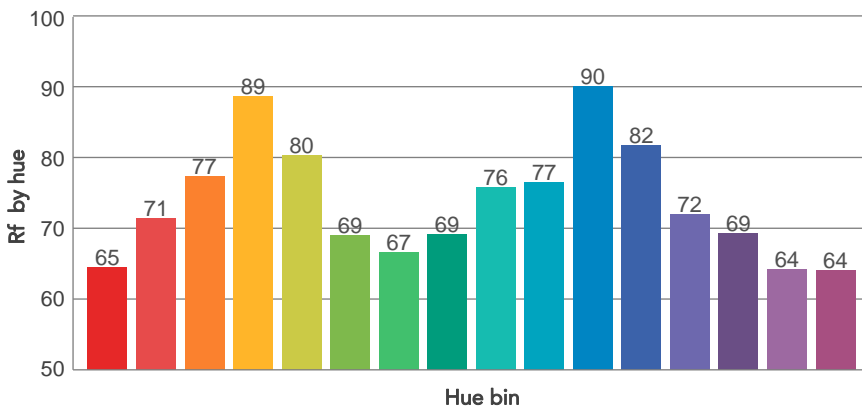
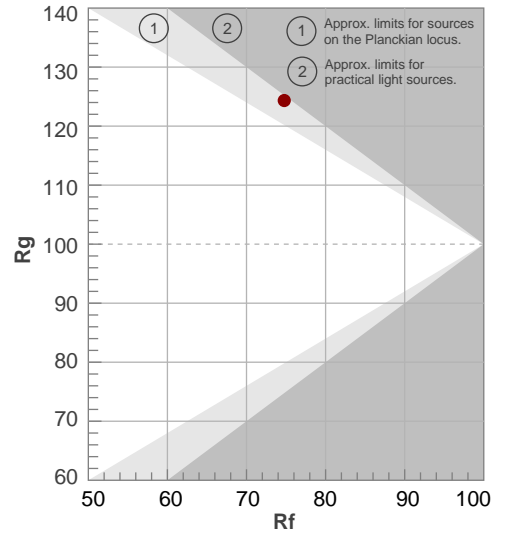

BEAM DETAILS



Beam angle 50%	Field angle 10%	Cut off angle 2,5%	Intensity ratio in 120° cone	Intensity ratio in 90° cone
4,2°	5,6°	6,1°	100,0%	100,0%

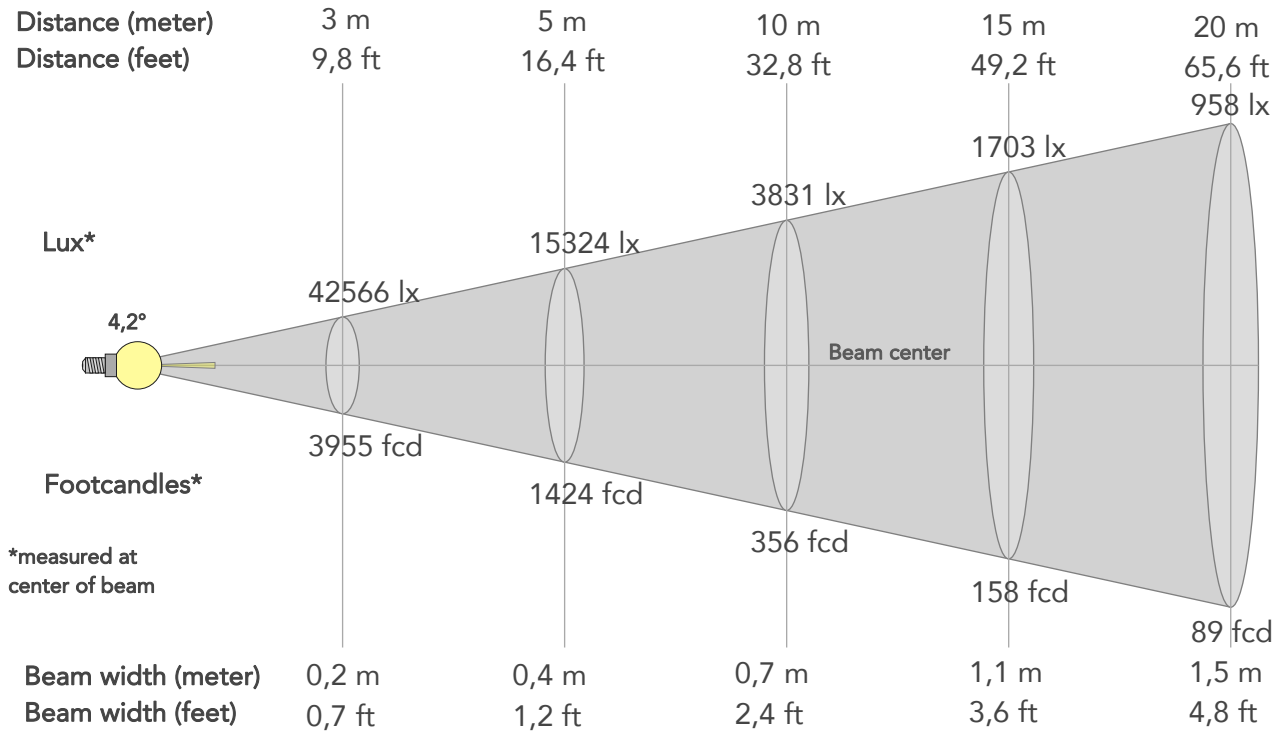

BEAM INTENSITIES AND WIDTHS

Distance	1m	2m	3m	4m	5m	7,5m	10m	15m	20m	25m	30m	40m	50m
Distance	3,3ft	6,6ft	9,8ft	13,1ft	16,4ft	24,6ft	32,8ft	49,2ft	65,6ft	82ft	98,4ft	131,2ft	164ft
Lux	383093lx	95773lx	42566lx	23943lx	15324lx	6811lx	3831lx	1703lx	958lx	613lx	426lx	239lx	153lx
Footcand.	35591fcd	8898fcd	3955fcd	2224fcd	1424fcd	633fcd	356fcd	158fcd	89fcd	57fcd	40fcd	22fcd	14fcd
Beam wid.	0,1m	0,1m	0,2m	0,3m	0,4m	0,6m	0,7m	1,1m	1,5m	1,8m	2,2m	2,9m	3,7m
Beam wid.	0,2ft	0,5ft	0,7ft	1ft	1,2ft	1,8ft	2,4ft	3,6ft	4,8ft	6ft	7,2ft	9,6ft	12ft

LINEAR DISTRIBUTION DIAGRAM

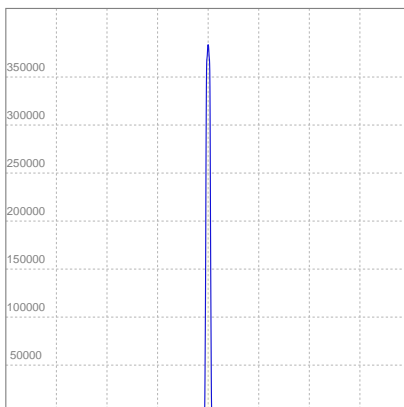

ELECTRICAL SPECIFICATIONS

Input voltage	Input current	Input power	Effeciency
224V	0,818A	164W	10lm/W

ISO CANDELA DIAGRAM

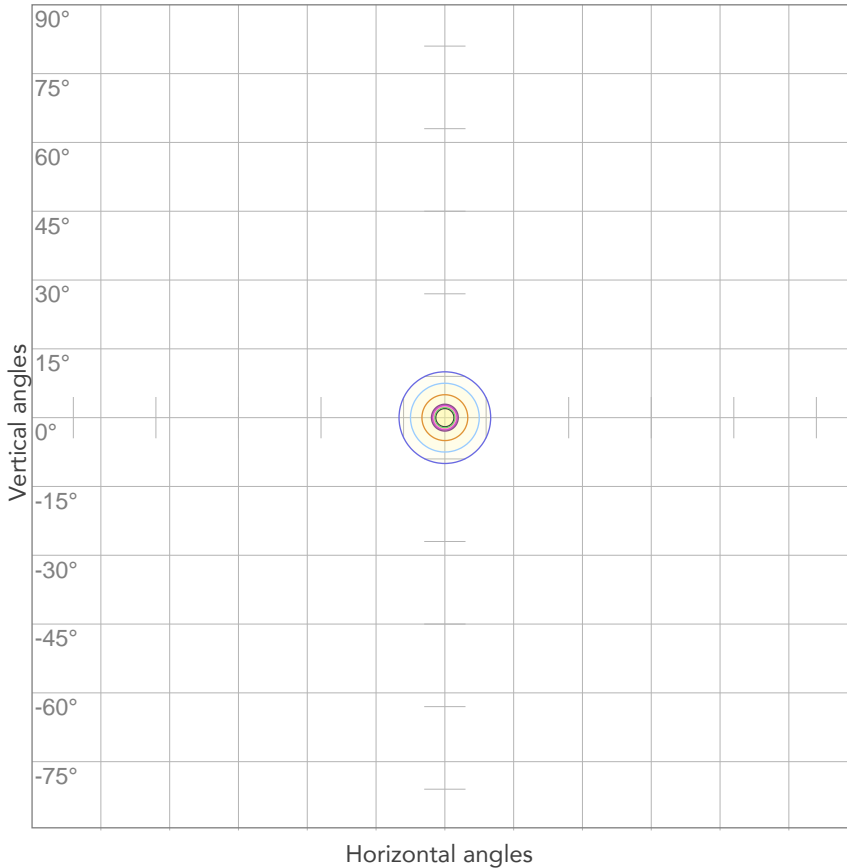

10%	38309 cd
20%	76619 cd
30%	114928 cd
40%	153237 cd
50%	191547 cd
60%	229856 cd
70%	268165 cd
80%	306475 cd

Conditions:

Number of c-planes: 2

Candela at center: 383093 cd

ISO LUX DIAGRAM

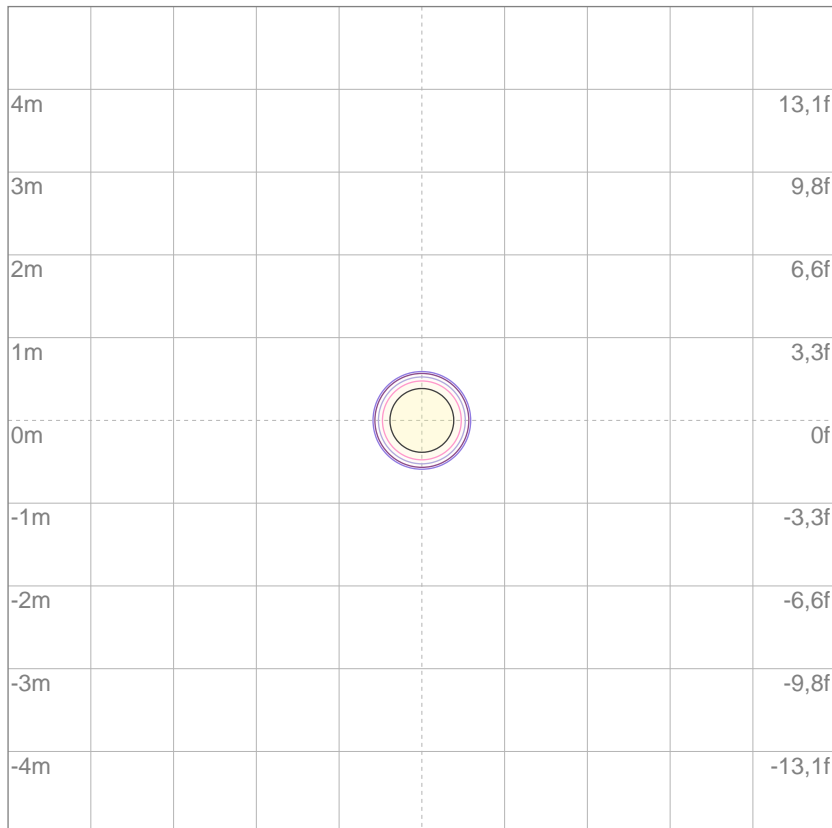

3%	115 lx
5%	192 lx
10%	383 lx
30%	1149 lx
50%	1915 lx

Conditions:

Number of c-planes: 2

Lux at center: 3831 lx

Lux distribution on a surface when lamp is mounted at 10 meters from the surface.

Mounting height: 10 meters (33 feet)



Total lumen output:

3159 lm

Peak candela output:

7976 cd

Light quality:

CRI: 58,3

Color temperature:

5669 K

PRODUCT NAME:

ASTRAWASH7PIXIP

MEASUREMENT CONDITIONS:

Beam angle:

Max Zoom

Target:

5600K

Operator:

Paolo Carvone

Date and time:

16/02/2021 10:34:50

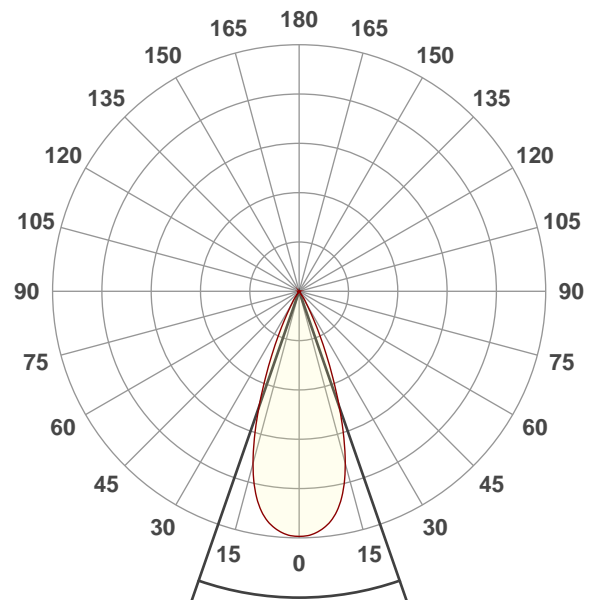

Beam angle 50%: 38,3°

Field angle 10%: 56,7°

Cut off angle 2.5%: 68,3°

Spectra

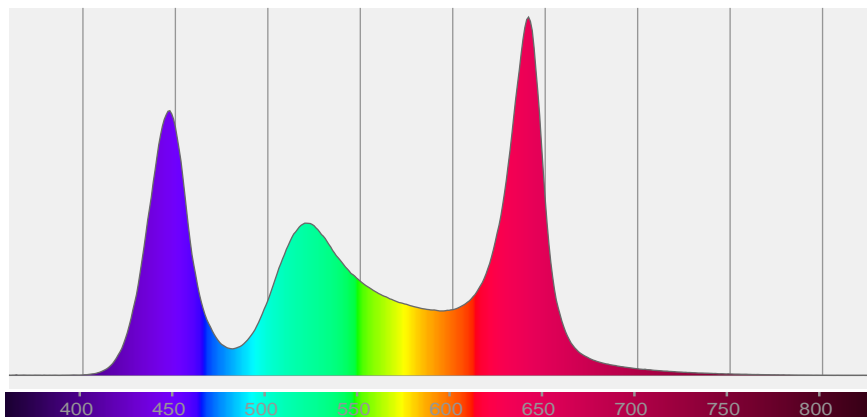

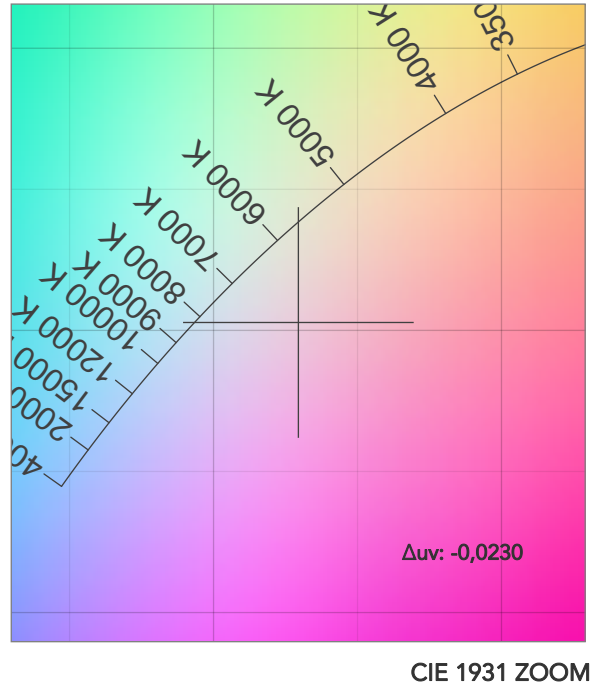
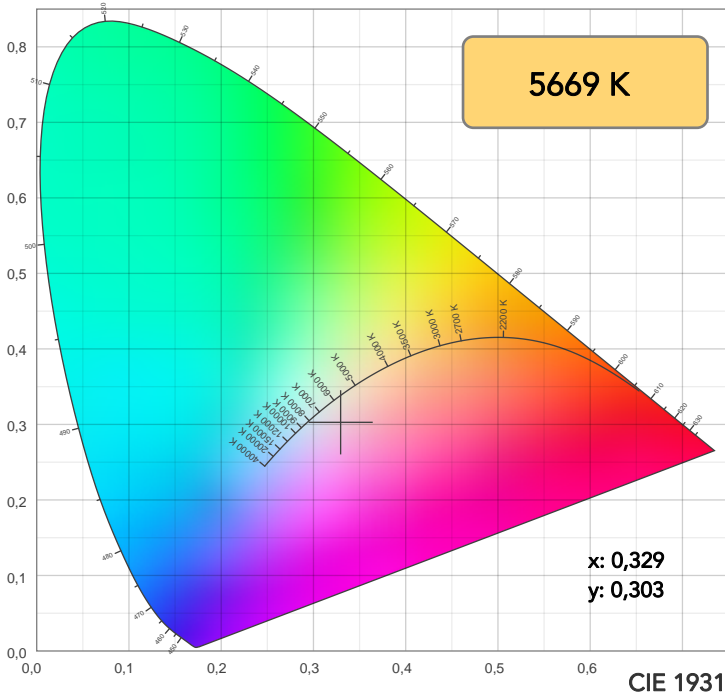

TM30: 73,2

CRI: 58,3 (R1-R8)

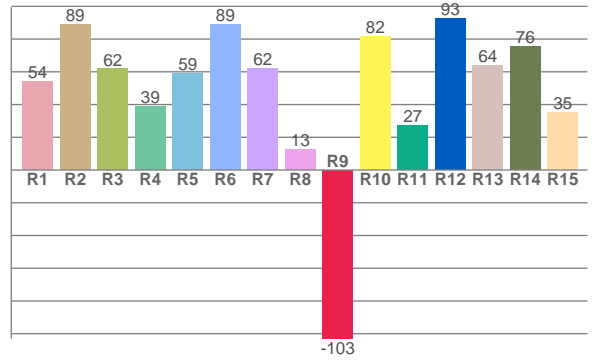
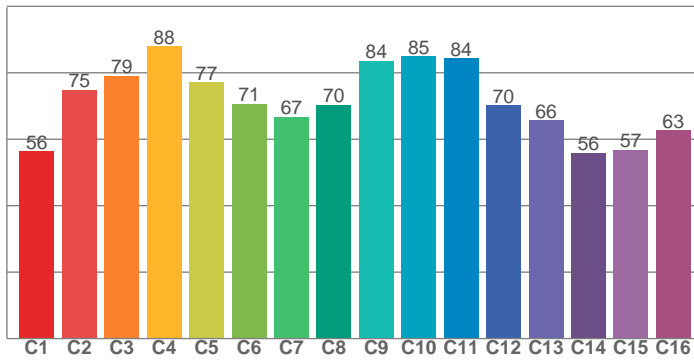

CRI R values, only R1-R8 are used to calculate final CRI value

R1	R2	R3	R4	R5	R6	R7	R8	R9	R10	R11	R12	R13	R14	R15
54,2	88,8	61,8	38,7	59,0	89,1	62,2	12,6	-103,0	81,7	27,5	92,8	63,6	75,7	35,3

TM30 C values, 16 binned values out of total of 99 C values

C1	C2	C3	C4	C5	C6	C7	C8	C9	C10	C11	C12	C13	C14	C15	C16
56,4	74,8	79,1	87,9	77,1	70,6	66,7	70,4	83,5	85,0	84,3	70,2	65,7	55,9	56,8	62,7

CQS Q values

Q1	Q2	Q3	Q4	Q5	Q6	Q7	Q8	Q9	Q10	Q11	Q12	Q13	Q14	Q15
78,2	85,9	81,9	91,4	75,7	77,5	95,8	76,7	72,4	89,9	93,0	83,2	80,3	84,9	84,6

CQS: 82,1

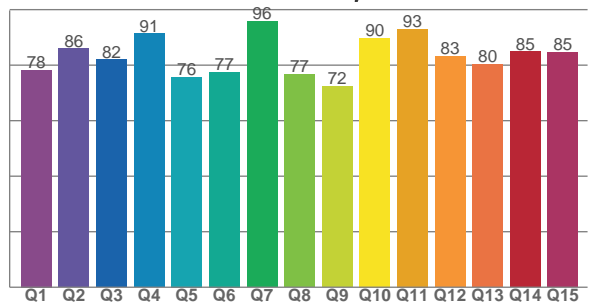

COLOR PARAMETERS

Color temperature	Color rendering index	Red component	Color fidelity	Color gamut	Color quality scale	Television lighting index	Color coordinate cie 1931	Color coordinate cie 1931	Color deviation from black body
CCT	CRI	CRI R9	TM30 Rf	TM30 Rg	CQS	TLCI	x	y	Δuv
5669 K	58,3	-103,0	73,2	126,0	82,1	49	0,329	0,303	-0,0230

TM30 DETAILS

Rf 73,2
Fidelity index Rf

Rg 126,0
Gammut index

Hue Bin	R _f	Graphic shifts (%)	
		Chroma	Hue
1	56	23%	-2%
2	75	13%	-8%
3	79	10%	-5%
4	88	5%	5%
5	77	10%	10%
6	71	19%	11%
7	67	22%	3%
8	70	17%	-5%
9	84	9%	-11%
10	85	1%	-7%
11	84	-1%	9%
12	70	-2%	21%
13	66	4%	31%
14	56	12%	26%
15	57	29%	29%
16	63	22%	4%

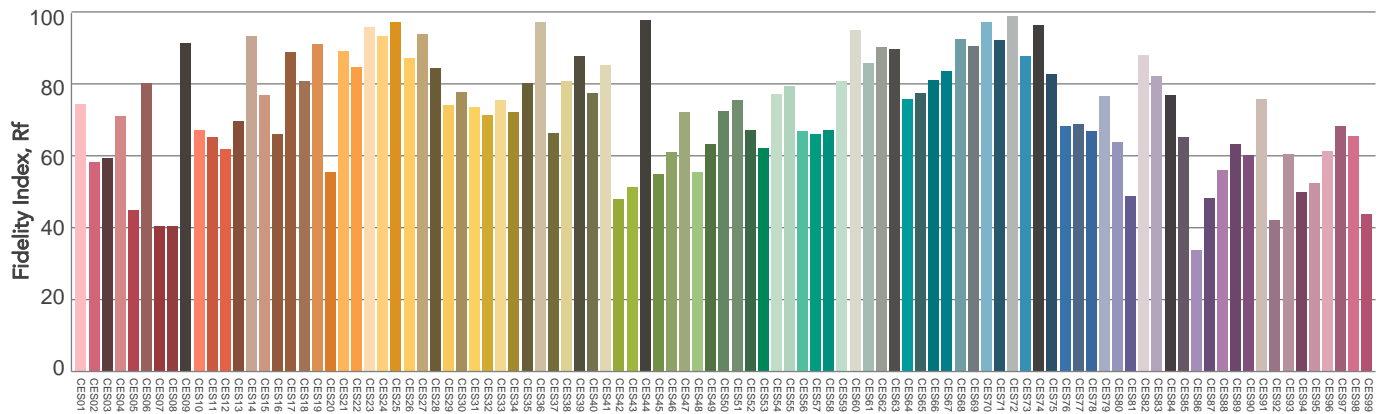
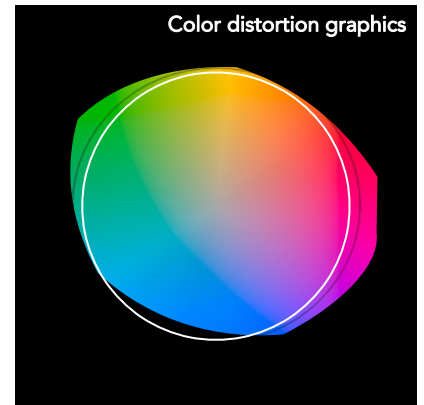
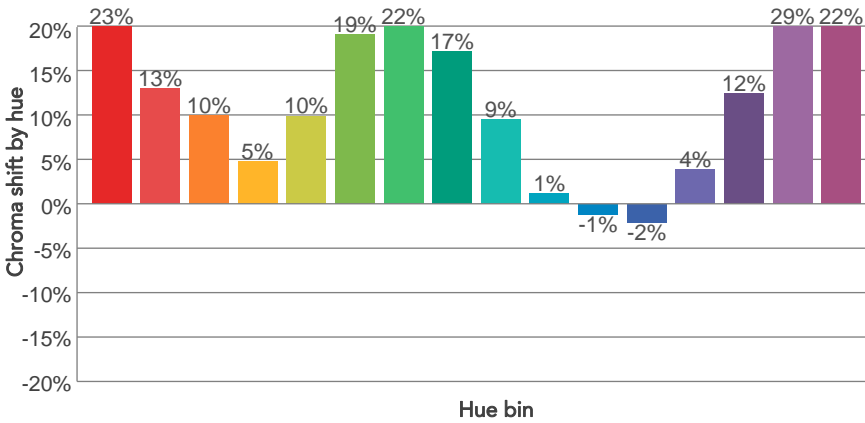
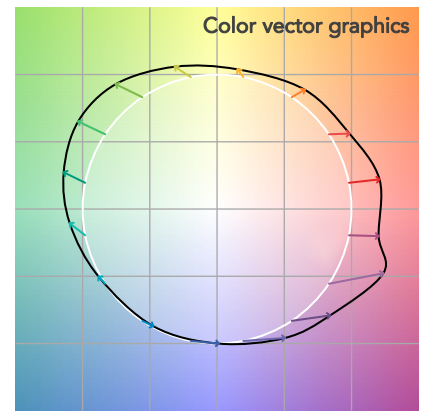
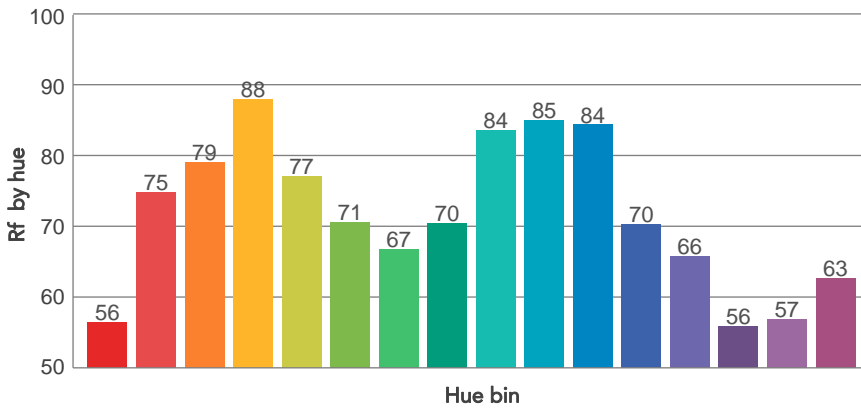
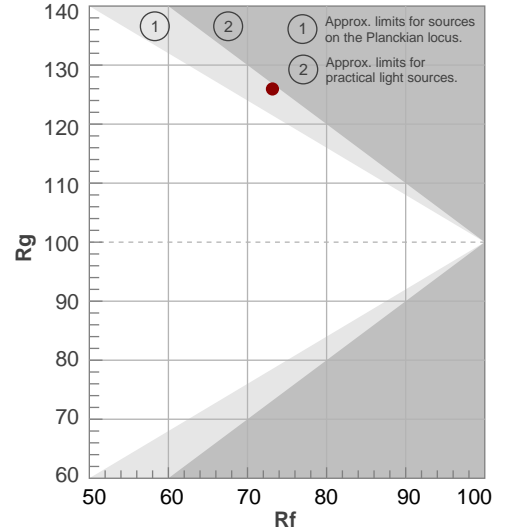

BEAM DETAILS



Beam angle 50%	Field angle 10%	Cut off angle 2,5%	Intensity ratio in 120° cone	Intensity ratio in 90° cone
38,3°	56,7°	68,3°	100,0%	100,0%

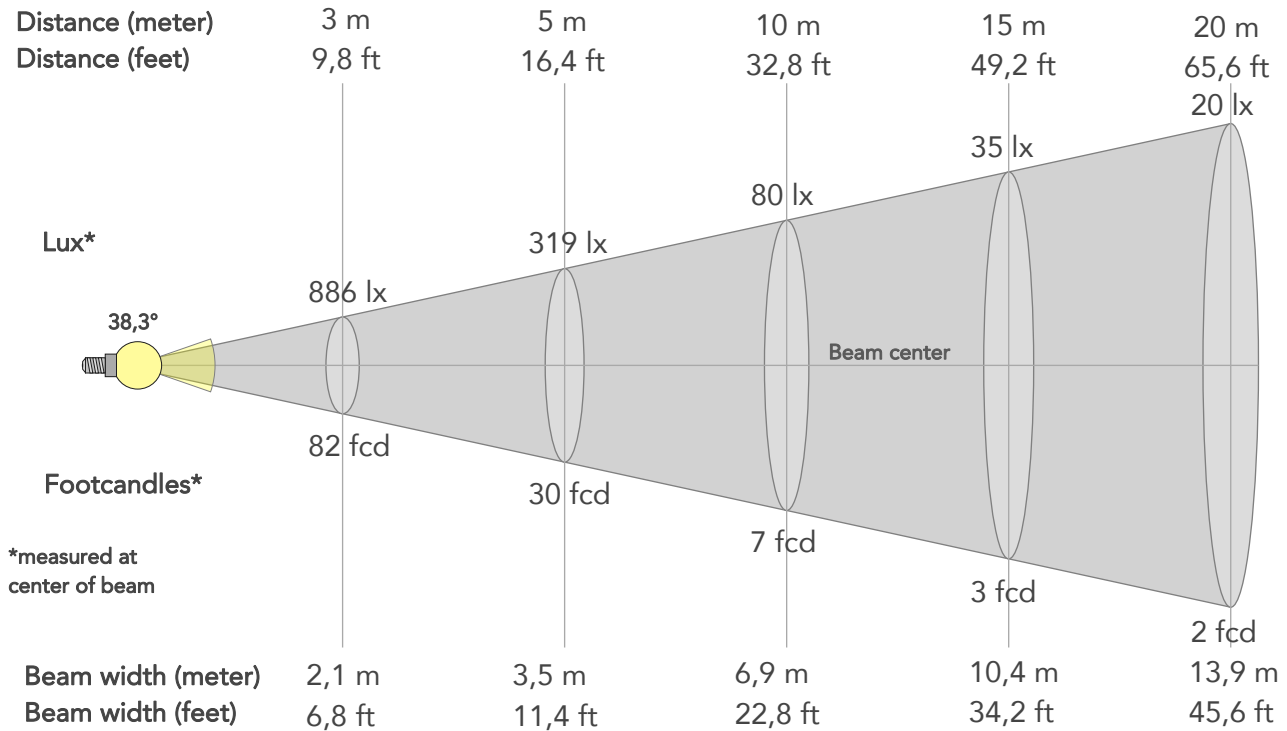

BEAM INTENSITIES AND WIDTHS

Distance	1m	2m	3m	4m	5m	7,5m	10m	15m	20m	25m	30m	40m	50m
Distance	3,3ft	6,6ft	9,8ft	13,1ft	16,4ft	24,6ft	32,8ft	49,2ft	65,6ft	82ft	98,4ft	131,2ft	164ft
Lux	7976lx	1994lx	886lx	498lx	319lx	142lx	80lx	35lx	20lx	13lx	9lx	5lx	3lx
Footcand.	741fcd	185fcd	82fcd	46fcd	30fcd	13fcd	7fcd	3fcd	2fcd	1fcd	1fcd	0fcd	0fcd
Beam wid.	0,7m	1,4m	2,1m	2,8m	3,5m	5,2m	6,9m	10,4m	13,9m	17,4m	20,8m	27,8m	34,7m
Beam wid.	2,3ft	4,6ft	6,8ft	9,1ft	11,4ft	17,1ft	22,8ft	34,2ft	45,6ft	57ft	68,4ft	91,2ft	113,9ft

LINEAR DISTRIBUTION DIAGRAM

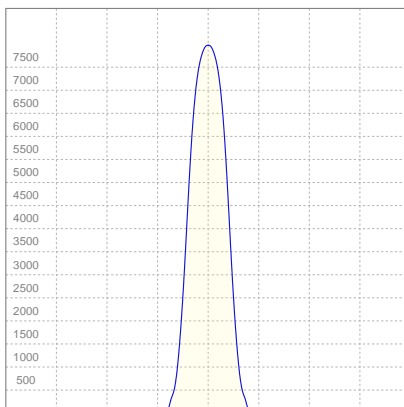

ELECTRICAL SPECIFICATIONS

Input voltage	Input current	Input power	Effeciency
223V	0,871A	176W	18lm/W

ISO CANDELA DIAGRAM

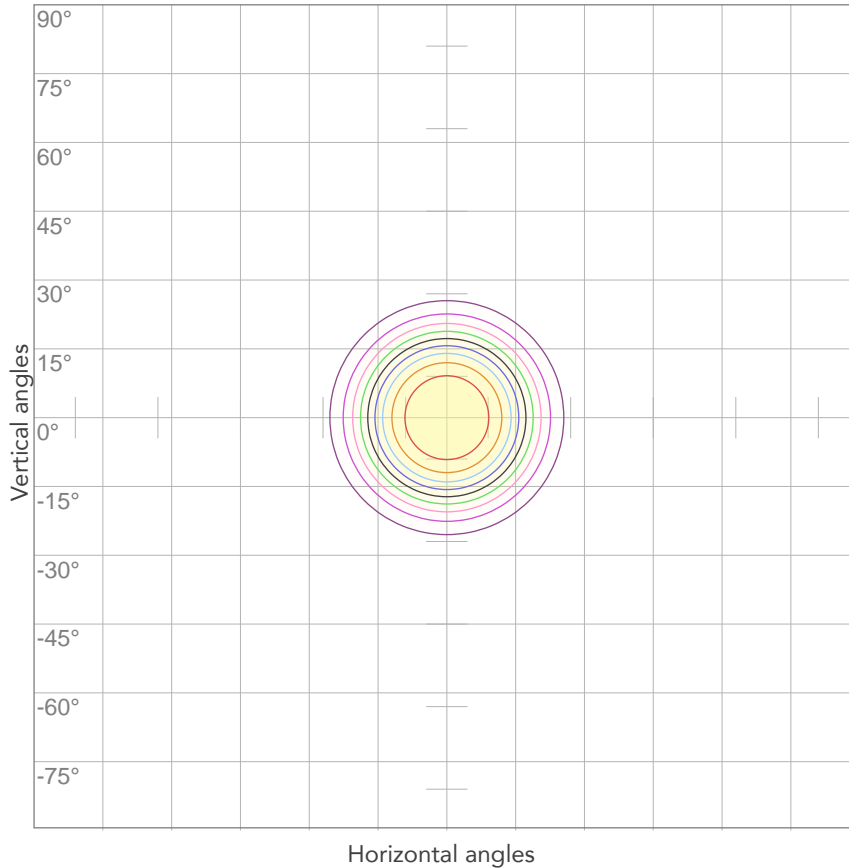

10%	798 cd
20%	1595 cd
30%	2393 cd
40%	3190 cd
50%	3988 cd
60%	4786 cd
70%	5583 cd
80%	6381 cd

Conditions:

Number of c-planes: 2

Candela at center: 7976 cd

ISO LUX DIAGRAM

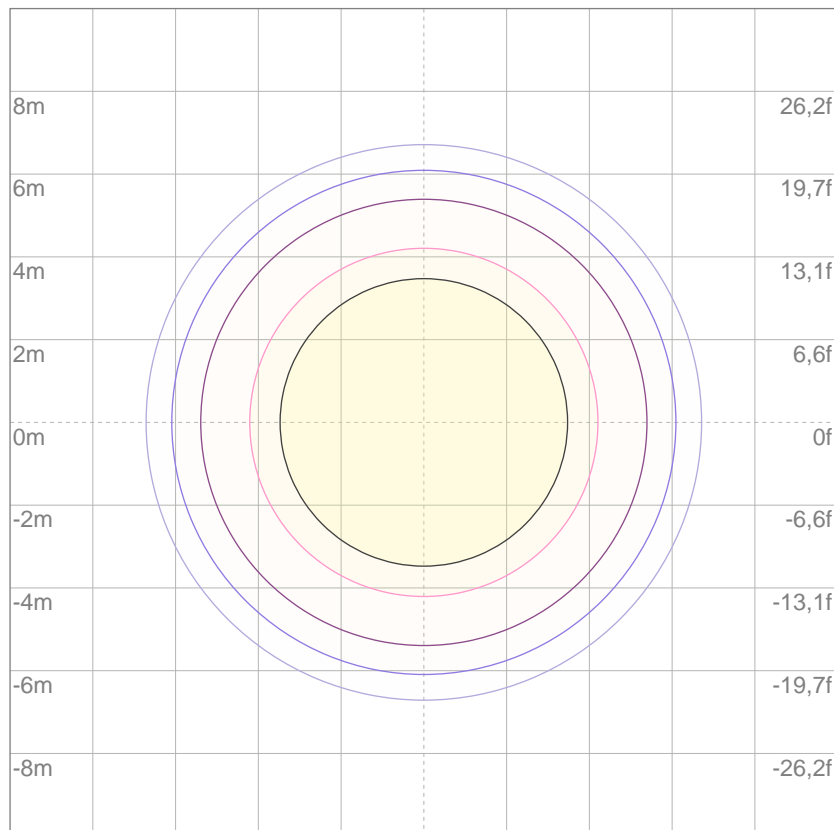

3%	2,39 lx
5%	3,99 lx
10%	7,98 lx
30%	23,9 lx
50%	39,9 lx

Conditions:

Number of c-planes: 2

Lux at center: 79,8 lx

Lux distribution on a surface when lamp is mounted at 10 meters from the surface.

Mounting height: 10 meters (33 feet)



Total lumen output:

2770 lm

Peak candela output:

29642 cd

Light quality:

CRI: 57,7

Color temperature:

5668 K

PRODUCT NAME:

ASTRAWASH7PIXIP

MEASUREMENT CONDITIONS:

Beam angle:

Med Zoom

Target:

5600K

Operator:

Paolo Carvone

Date and time:

16/02/2021 10:32:16

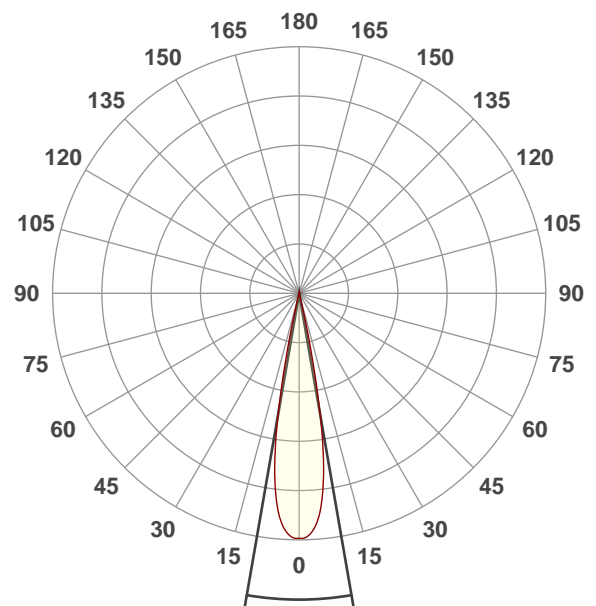

Beam angle 50%: 19,7°

Field angle 10%: 26°

Cut off angle 2.5%: 28,5°

Spectra

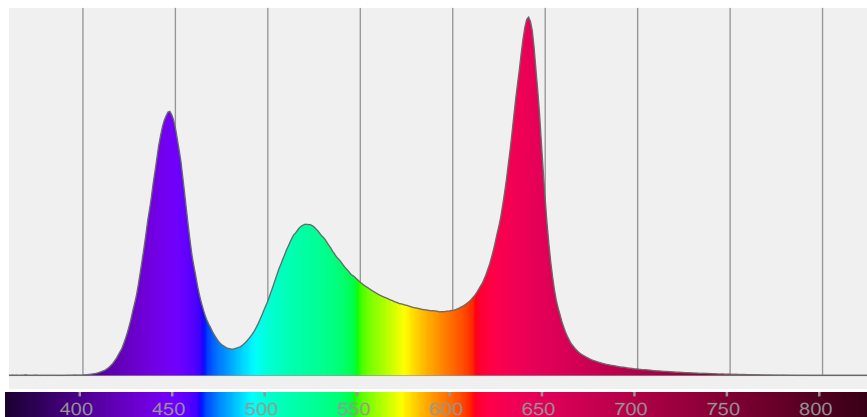

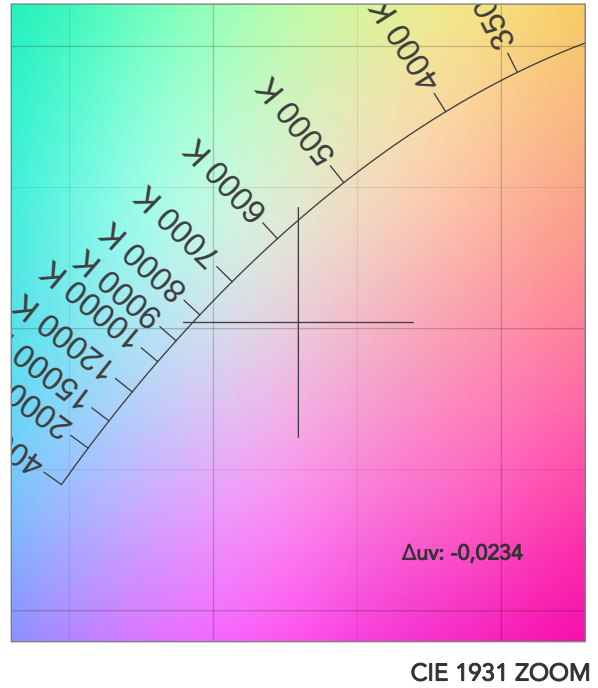
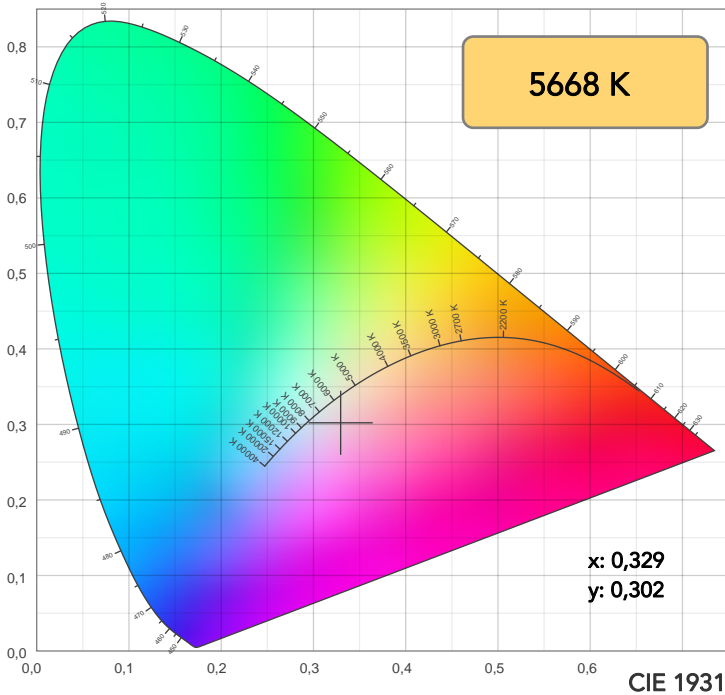

TM30: 72,9

CRI: 57,7 (R1-R8)

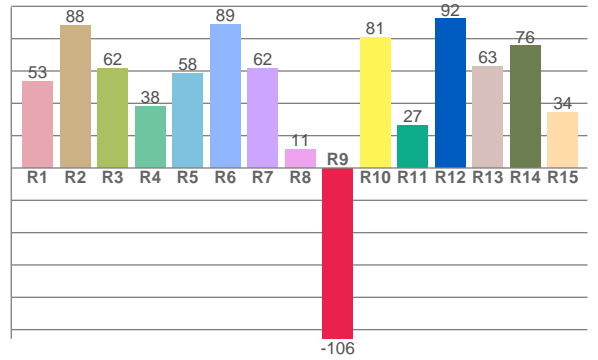
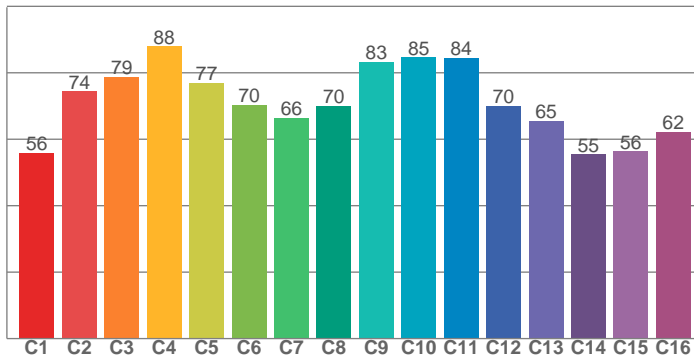

CRI R values, only R1-R8 are used to calculate final CRI value

R1	R2	R3	R4	R5	R6	R7	R8	R9	R10	R11	R12	R13	R14	R15
53,5	88,4	61,6	37,9	58,3	88,7	61,8	11,5	-105,5	80,9	26,5	92,2	62,9	75,5	34,3

TM30 C values, 16 binned values out of total of 99 C values

C1	C2	C3	C4	C5	C6	C7	C8	C9	C10	C11	C12	C13	C14	C15	C16
55,9	74,4	78,7	87,9	77,0	70,4	66,4	70,0	83,3	84,7	84,4	70,1	65,5	55,4	56,4	62,3

CQS Q values

Q1	Q2	Q3	Q4	Q5	Q6	Q7	Q8	Q9	Q10	Q11	Q12	Q13	Q14	Q15
77,9	85,8	82,0	91,1	75,5	77,4	95,7	76,4	72,2	89,9	92,8	82,9	80,1	84,7	84,4

CQS: 82,0

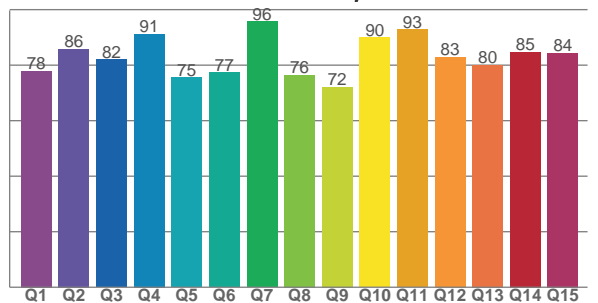

COLOR PARAMETERS

Color temperature	Color rendering index	Red component	Color fidelity	Color gamut	Color quality scale	Television lighting index	Color coordinate cie 1931	Color coordinate cie 1931	Color deviation from black body
CCT	CRI	CRI R9	TM30 Rf	TM30 Rg	CQS	TLCI	x	y	Δuv
5668 K	57,7	-105,5	72,9	126,2	82,0	49	0,329	0,302	-0,0234

TM30 DETAILS

Rf 72,9
Fidelity index Rf

Rg 126,2
Gammut index

Hue Bin	R _f	Graphic shifts (%)	
		Chroma	Hue
1	56	23%	-2%
2	74	13%	-8%
3	79	10%	-5%
4	88	5%	5%
5	77	10%	10%
6	70	19%	11%
7	66	22%	3%
8	70	17%	-5%
9	83	10%	-11%
10	85	1%	-7%
11	84	-1%	9%
12	70	-2%	21%
13	65	4%	31%
14	55	13%	26%
15	56	30%	29%
16	62	22%	4%

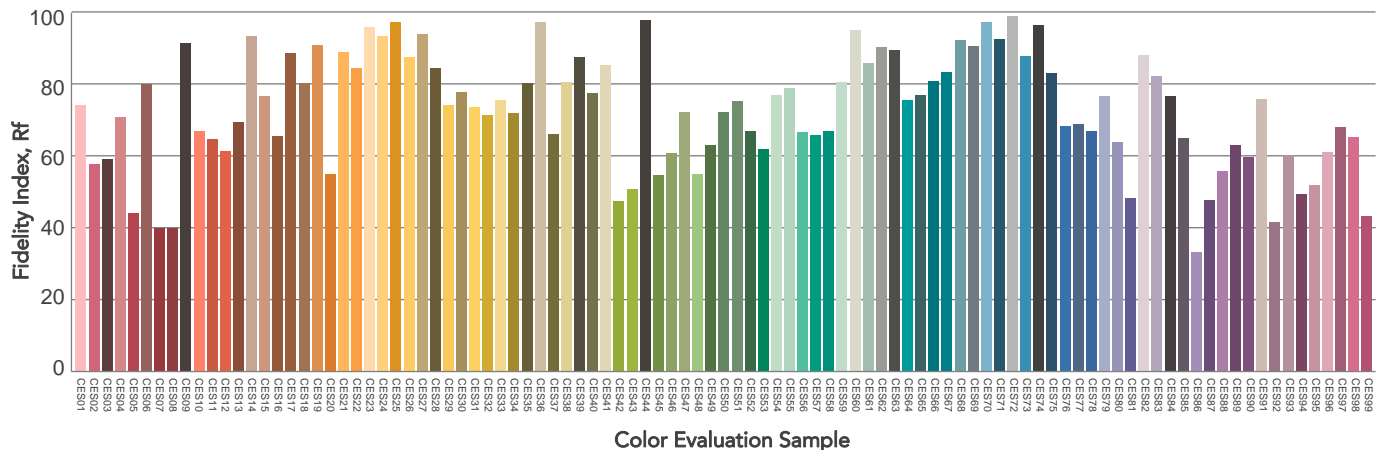
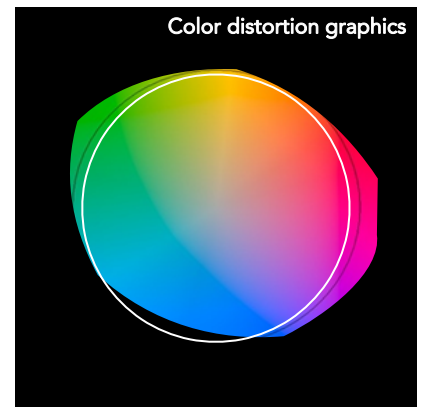
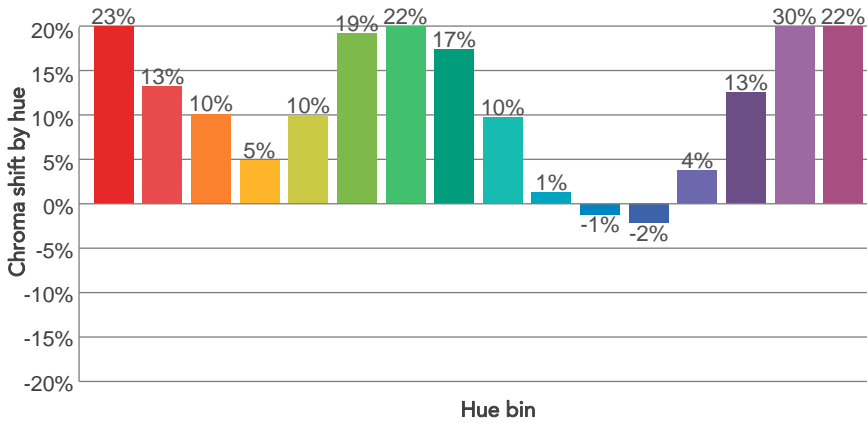
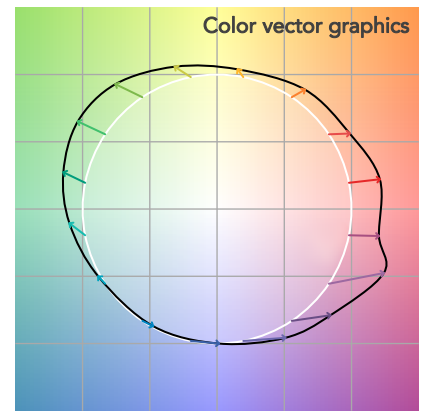
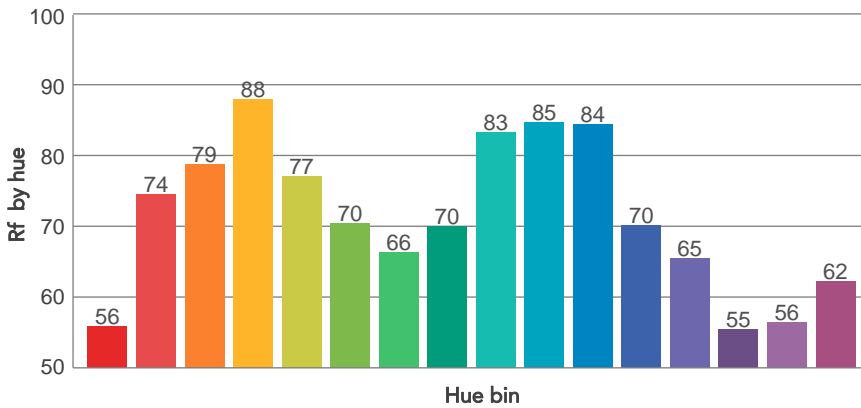
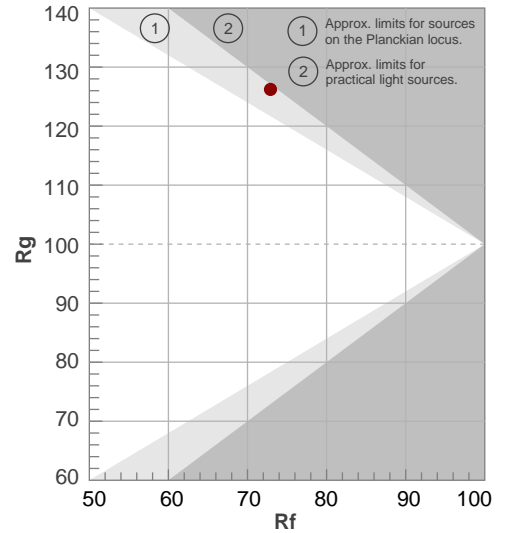

BEAM DETAILS



Beam angle 50%	Field angle 10%	Cut off angle 2,5%	Intensity ratio in 120° cone	Intensity ratio in 90° cone
19,7°	26°	28,5°	100,0%	100,0%

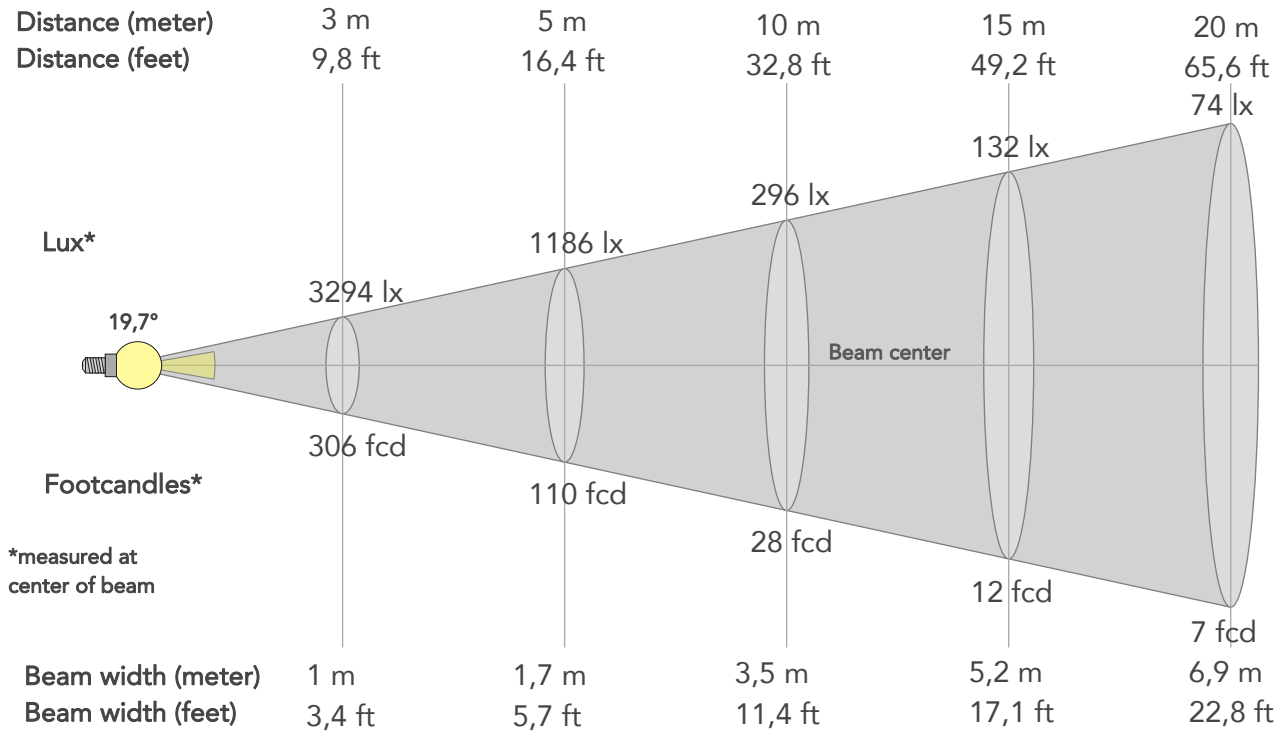

BEAM INTENSITIES AND WIDTHS

Distance	1m	2m	3m	4m	5m	7,5m	10m	15m	20m	25m	30m	40m	50m
Distance	3,3ft	6,6ft	9,8ft	13,1ft	16,4ft	24,6ft	32,8ft	49,2ft	65,6ft	82ft	98,4ft	131,2ft	164ft
Lux	29642lx	7411lx	3294lx	1853lx	1186lx	527lx	296lx	132lx	74lx	47lx	33lx	19lx	12lx
Footcand.	2754fcd	688fcd	306fcd	172fcd	110fcd	49fcd	28fcd	12fcd	7fcd	4fcd	3fcd	2fcd	1fcd
Beam wid.	0,3m	0,7m	1m	1,4m	1,7m	2,6m	3,5m	5,2m	6,9m	8,7m	10,4m	13,9m	17,3m
Beam wid.	1,1ft	2,3ft	3,4ft	4,5ft	5,7ft	8,5ft	11,4ft	17,1ft	22,8ft	28,4ft	34,1ft	45,5ft	56,9ft

LINEAR DISTRIBUTION DIAGRAM

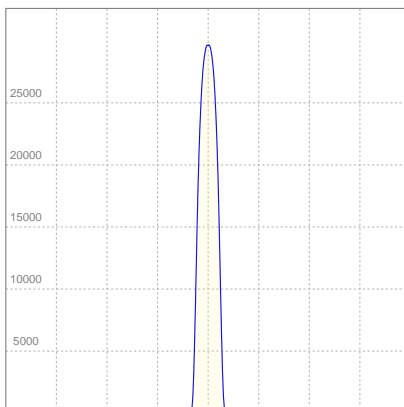

ELECTRICAL SPECIFICATIONS

Input voltage	Input current	Input power	Effeciency
222V	0,873A	176,1W	16lm/W

ISO CANDELA DIAGRAM

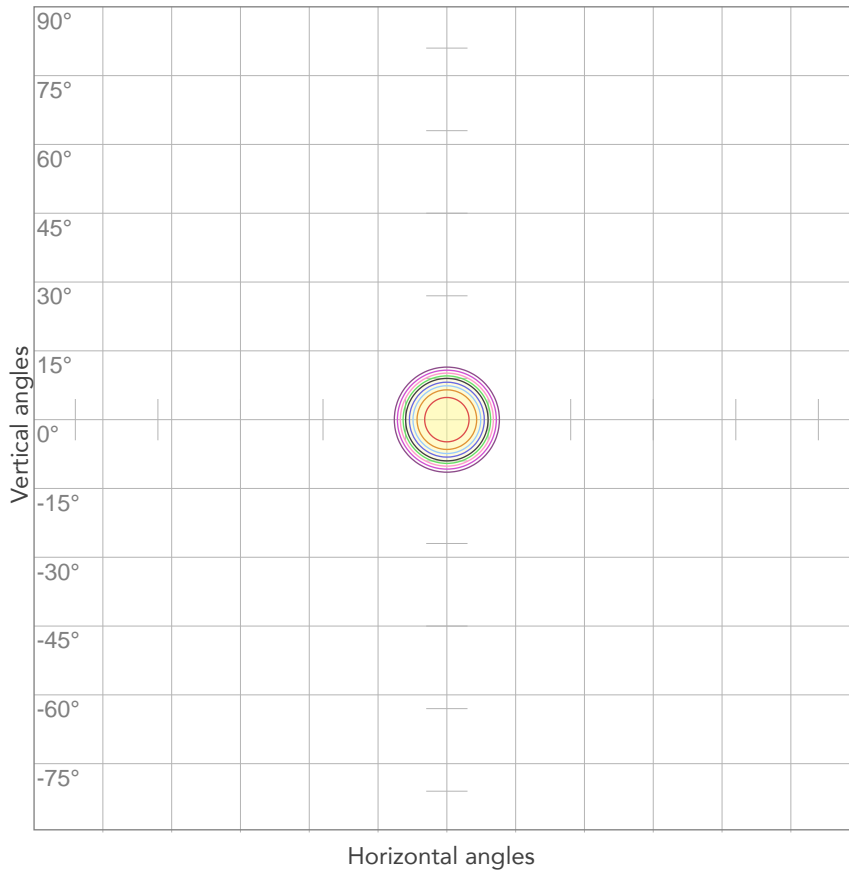

10%	2964 cd
20%	5928 cd
30%	8893 cd
40%	11857 cd
50%	14821 cd
60%	17785 cd
70%	20750 cd
80%	23714 cd

Conditions:

Number of c-planes: 2

Candela at center: 29642 cd

ISO LUX DIAGRAM

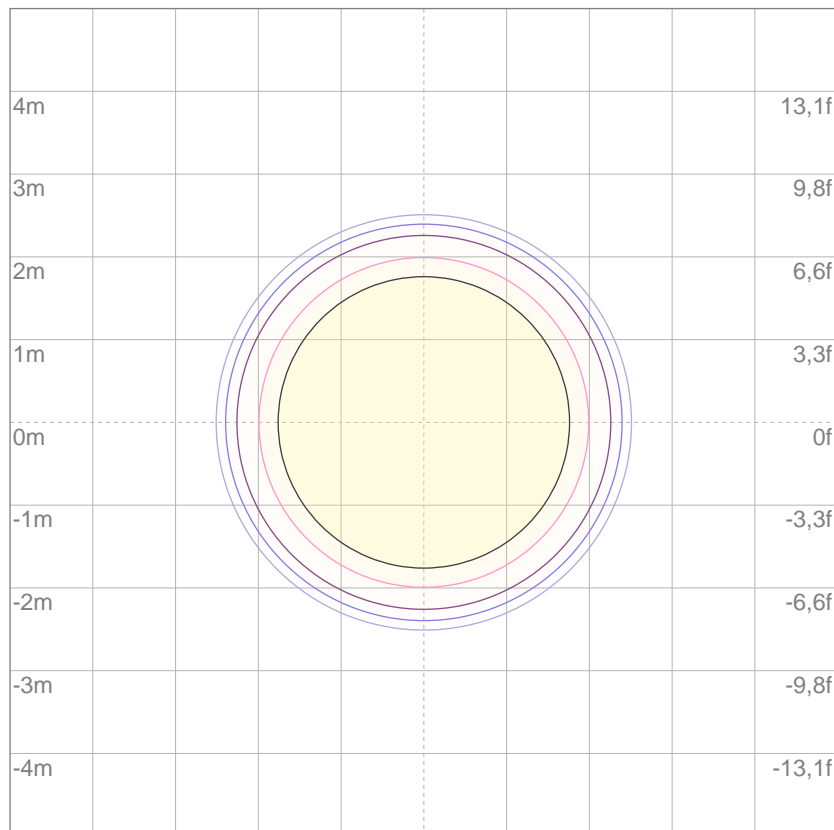

Mounting height: 10 meters (33 feet)

3%	8,89 lx
5%	14,8 lx
10%	29,6 lx
30%	88,9 lx
50%	148 lx

Conditions:

Number of c-planes: 2

Lux at center: 296 lx

Lux distribution on a surface when lamp is mounted at 10 meters from the surface.



Total lumen output:

1858 lm

Peak candela output:

396093 cd

Light quality:

CRI: 56,5

Color temperature:

5613 K

PRODUCT NAME:

ASTRAWASH7PIXIP

MEASUREMENT CONDITIONS:

Beam angle:

Min Zoom

Target:

5600K

Operator:

Paolo Carvone

Date and time:

16/02/2021 10:27:37

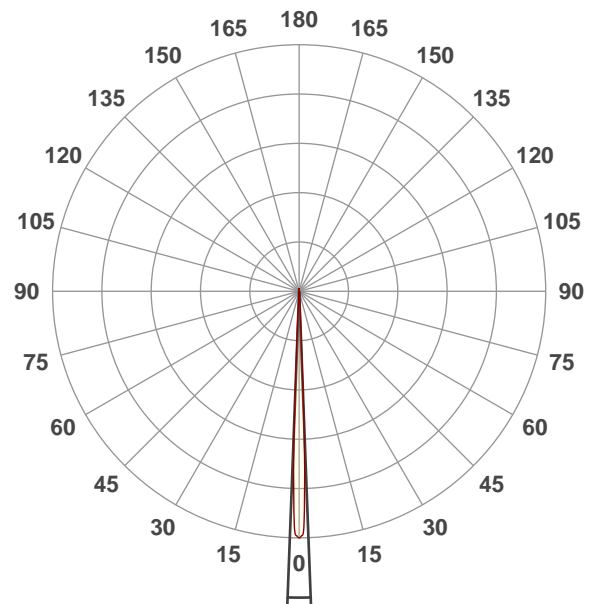

Beam angle 50%: 4,3°

Field angle 10%: 6°

Cut off angle 2.5%: 6,7°

Spectra

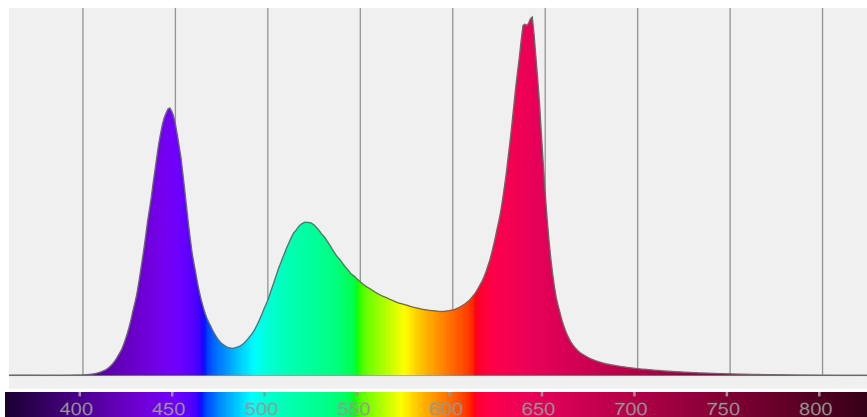

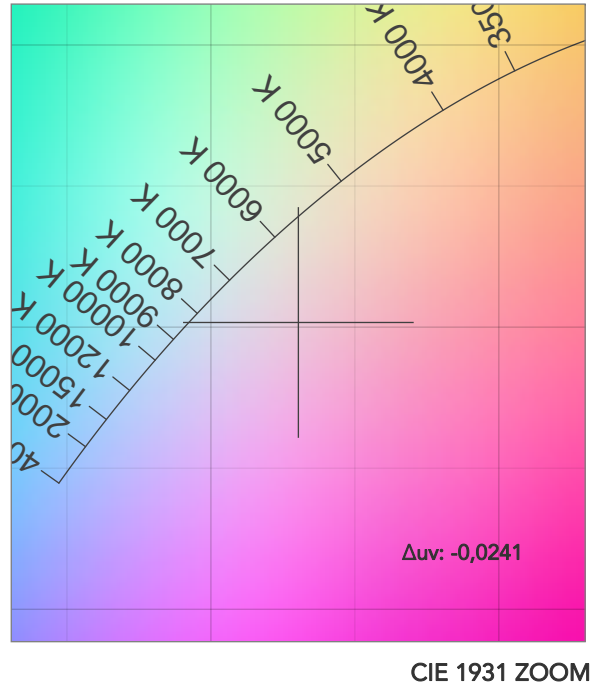
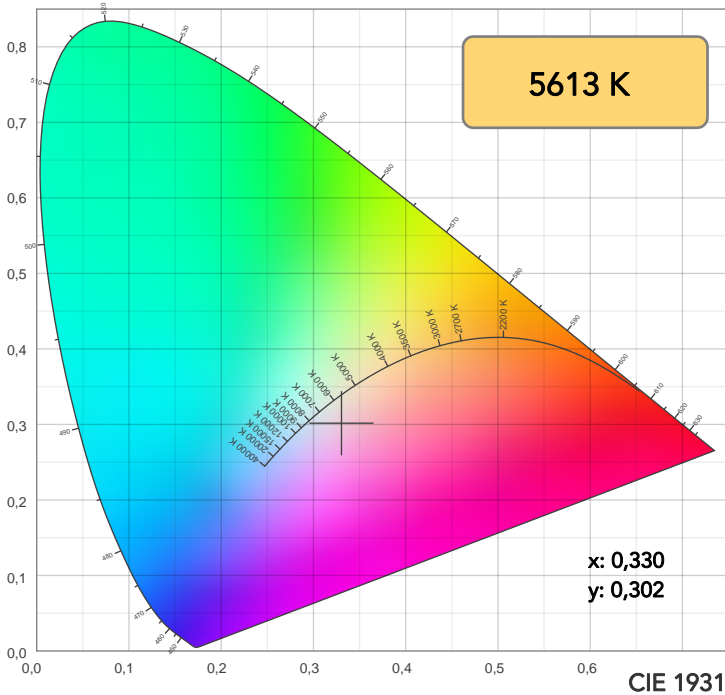

TM30: 72,6

CRI: 56,5 (R1-R8)

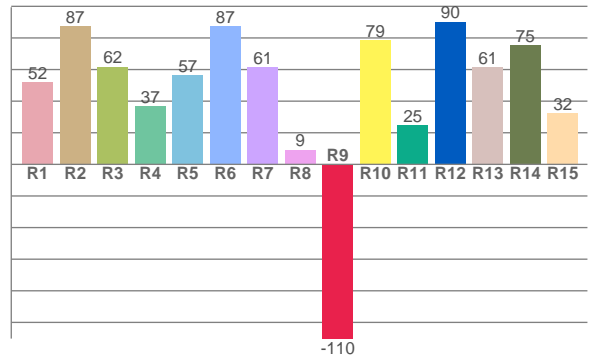
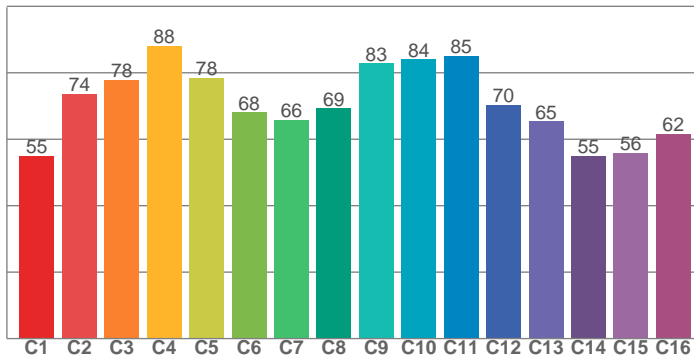

CRI R values, only R1-R8 are used to calculate final CRI value

R1	R2	R3	R4	R5	R6	R7	R8	R9	R10	R11	R12	R13	R14	R15
51,7	87,4	61,7	36,6	56,6	87,3	61,4	9,3	-110,2	78,7	24,7	90,3	61,3	75,5	32,2

TM30 C values, 16 binned values out of total of 99 C values

C1	C2	C3	C4	C5	C6	C7	C8	C9	C10	C11	C12	C13	C14	C15	C16
54,9	73,7	77,8	88,2	78,4	68,0	65,9	69,3	82,9	84,0	85,0	70,4	65,3	55,0	55,8	61,6

CQS Q values

Q1	Q2	Q3	Q4	Q5	Q6	Q7	Q8	Q9	Q10	Q11	Q12	Q13	Q14	Q15
77,3	85,8	82,4	90,4	75,0	77,3	95,4	75,8	72,0	90,4	92,0	82,1	79,6	84,3	83,9

CQS: 81,6

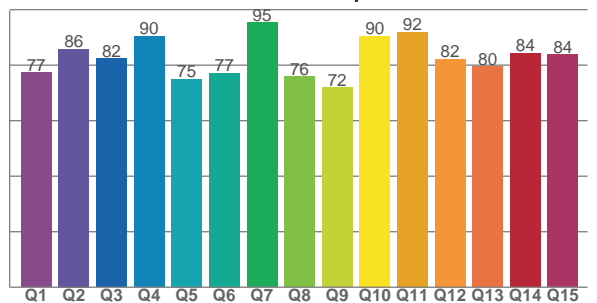

COLOR PARAMETERS

Color temperature	Color rendering index	Red component	Color fidelity	Color gamut	Color quality scale	Television lighting index	Color coordinate cie 1931	Color coordinate cie 1931	Color deviation from black body
CCT	CRI	CRI R9	TM30 Rf	TM30 Rg	CQS	TLCI	x	y	Δuv
5613 K	56,5	-110,2	72,6	126,6	81,6	48	0,330	0,302	-0,0241

TM30 DETAILS

Rf 72,6
Fidelity index Rf

Rg 126,6
Gammut index

Hue Bin	R _f	Graphic shifts (%)	
		Chroma	Hue
1	55	24%	-2%
2	74	14%	-8%
3	78	10%	-6%
4	88	5%	5%
5	78	10%	10%
6	68	19%	12%
7	66	23%	4%
8	69	18%	-4%
9	83	10%	-11%
10	84	2%	-8%
11	85	-1%	8%
12	70	-2%	21%
13	65	4%	31%
14	55	12%	27%
15	56	30%	30%
16	62	22%	4%

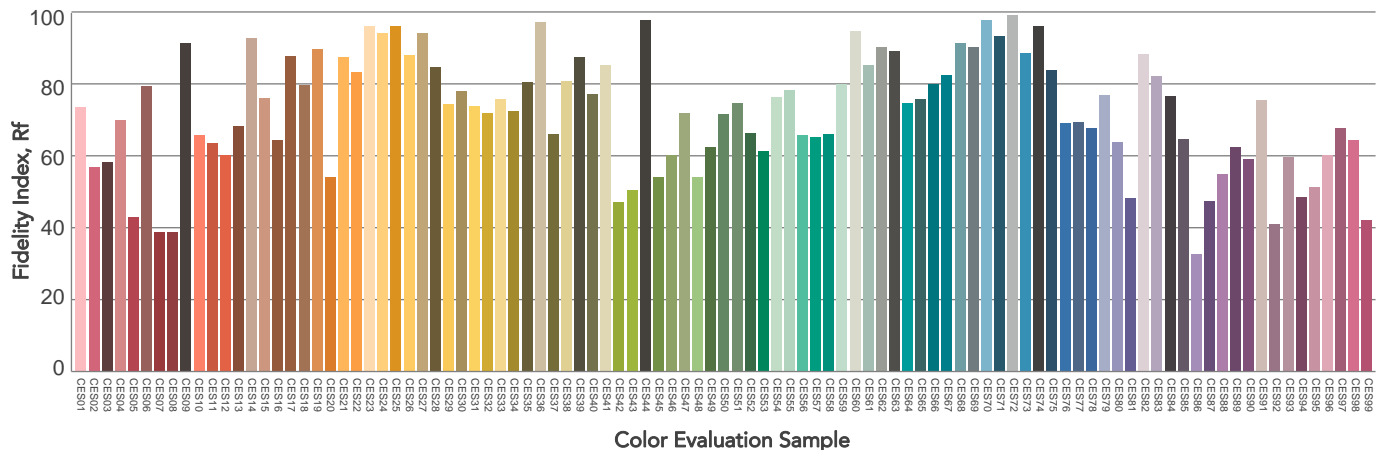
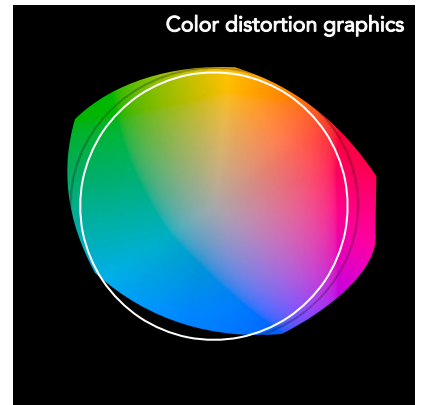
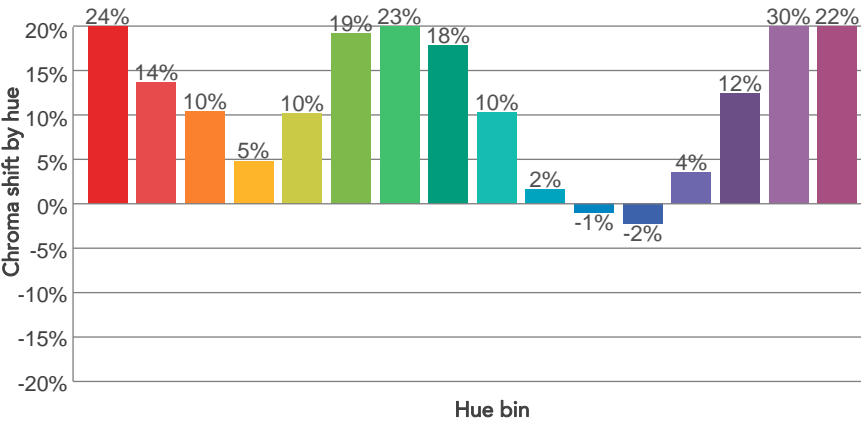
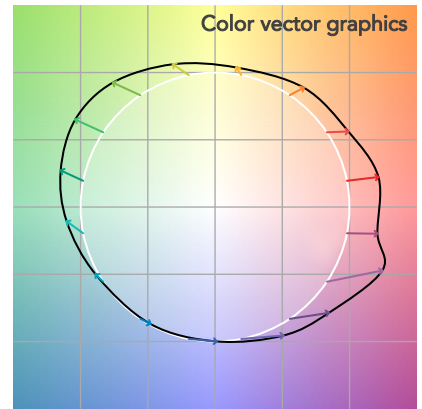
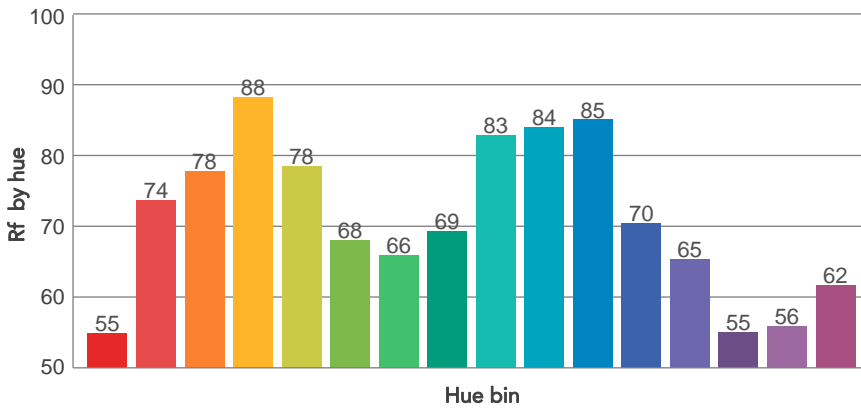
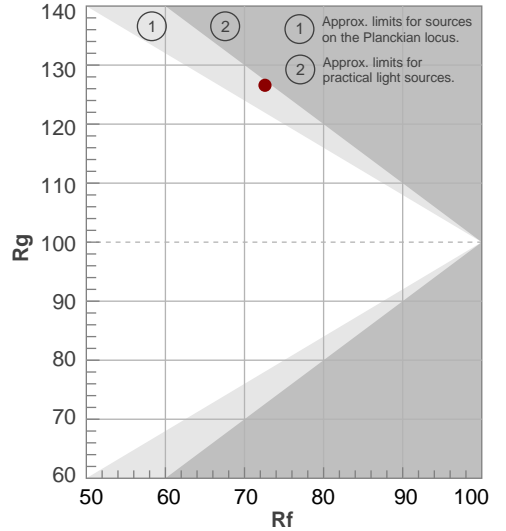

BEAM DETAILS



Beam angle 50%	Field angle 10%	Cut off angle 2,5%	Intensity ratio in 120° cone	Intensity ratio in 90° cone
4,3°	6°	6,7°	100,0%	100,0%

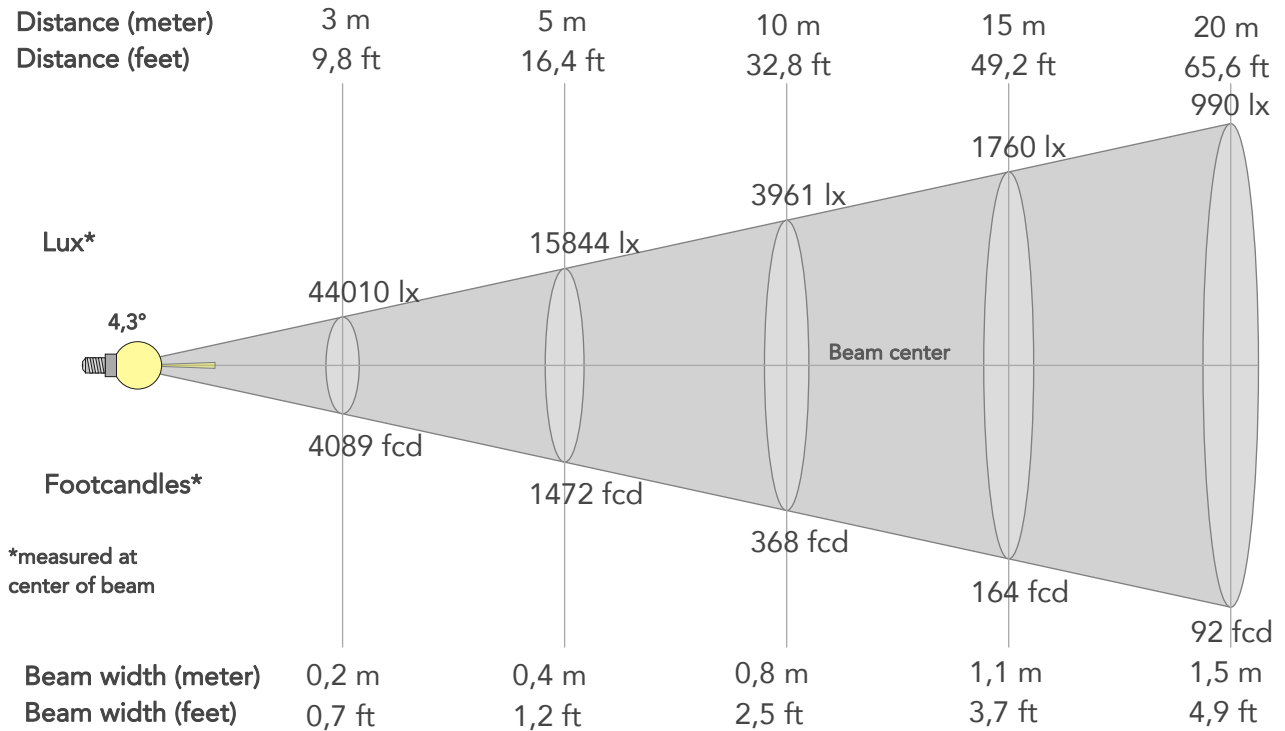

BEAM INTENSITIES AND WIDTHS

Distance	1m	2m	3m	4m	5m	7,5m	10m	15m	20m	25m	30m	40m	50m
Distance	3,3ft	6,6ft	9,8ft	13,1ft	16,4ft	24,6ft	32,8ft	49,2ft	65,6ft	82ft	98,4ft	131,2ft	164ft
Lux	396093lx	99023lx	44010lx	24756lx	15844lx	7042lx	3961lx	1760lx	990lx	634lx	440lx	248lx	158lx
Footcand.	36798fcd	9200fcd	4089fcd	2300fcd	1472fcd	654fcd	368fcd	164fcd	92fcd	59fcd	41fcd	23fcd	15fcd
Beam wid.	0,1m	0,2m	0,2m	0,3m	0,4m	0,6m	0,8m	1,1m	1,5m	1,9m	2,3m	3m	3,8m
Beam wid.	0,2ft	0,5ft	0,7ft	1ft	1,2ft	1,9ft	2,5ft	3,7ft	4,9ft	6,2ft	7,4ft	9,9ft	12,4ft

LINEAR DISTRIBUTION DIAGRAM

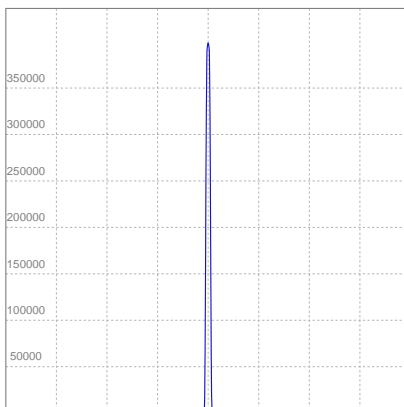

ELECTRICAL SPECIFICATIONS

Input voltage	Input current	Input power	Effeciency
222V	0,877A	175,9W	11lm/W

ISO CANDELA DIAGRAM

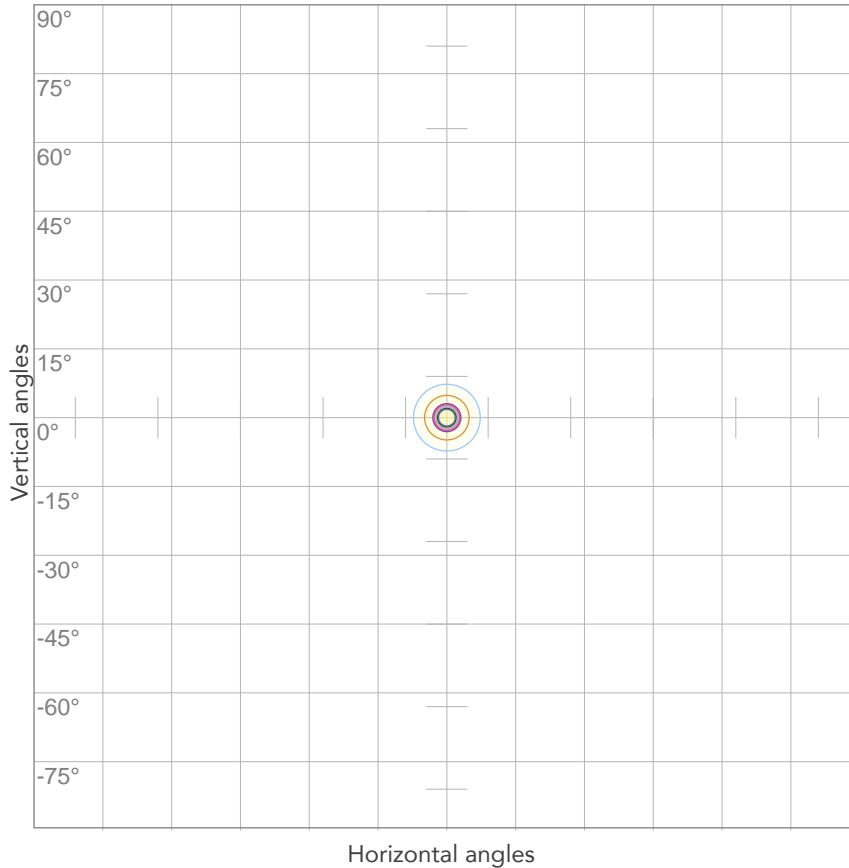

10%	39609 cd
20%	79219 cd
30%	118828 cd
40%	158437 cd
50%	198046 cd
60%	237656 cd
70%	277265 cd
80%	316874 cd

Conditions:

Number of c-planes: 2

Candela at center: 396093 cd

ISO LUX DIAGRAM

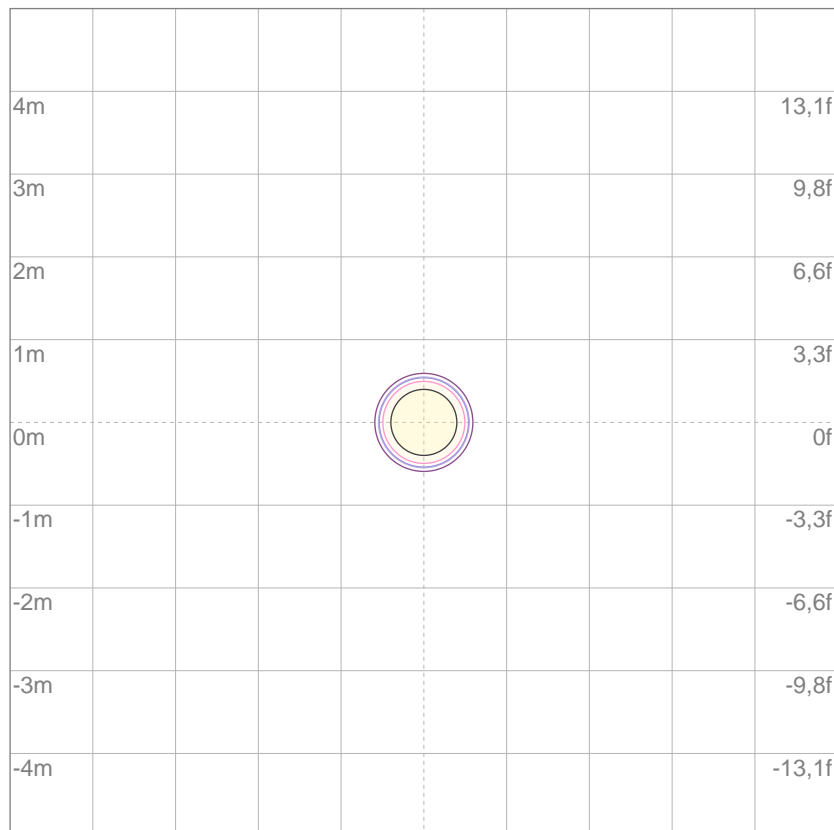

3%	119 lx
5%	198 lx
10%	396 lx
30%	1188 lx
50%	1980 lx

Conditions:

Number of c-planes: 2

Lux at center: 3961 lx

Lux distribution on a surface when lamp is mounted at 10 meters from the surface.

Mounting height: 10 meters (33 feet)



Total lumen output:

3137 lm

Peak candela output:

7904 cd

Light quality:

CRI: 59,6

Color temperature:

6176 K

PRODUCT NAME:

ASTRAWASH7PIXIP

MEASUREMENT CONDITIONS:

Beam angle:

Max Zoom

Target:

6000K

Operator:

Paolo Carvone

Date and time:

16/02/2021 12:20:34

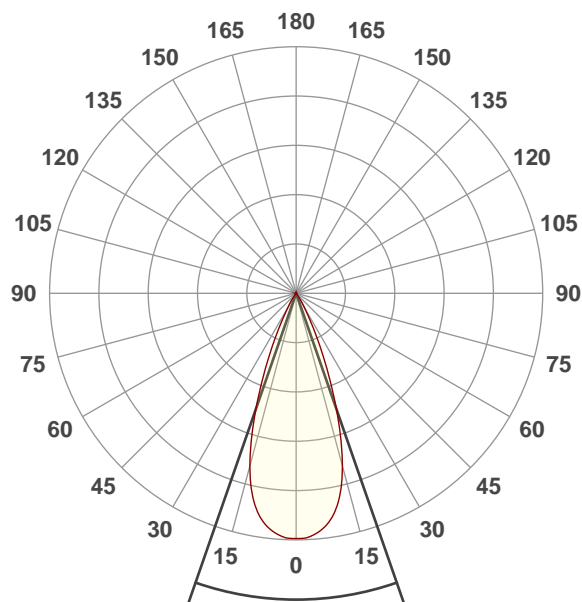

Beam angle 50%: 38,4°

Field angle 10%: 56,7°

Cut off angle 2.5%: 68,2°

Spectra

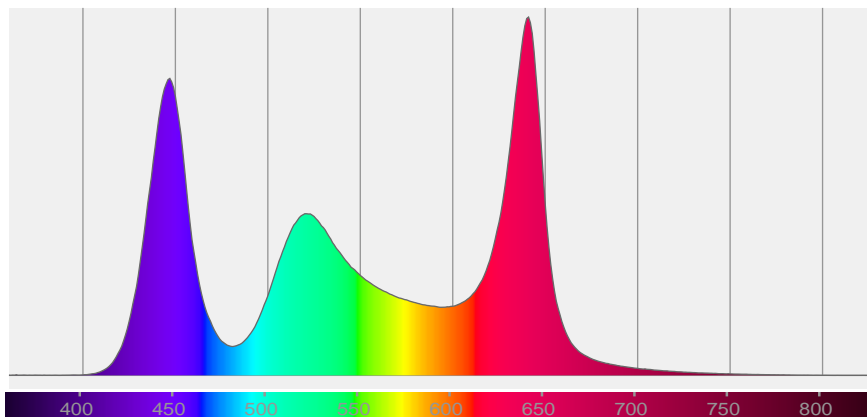

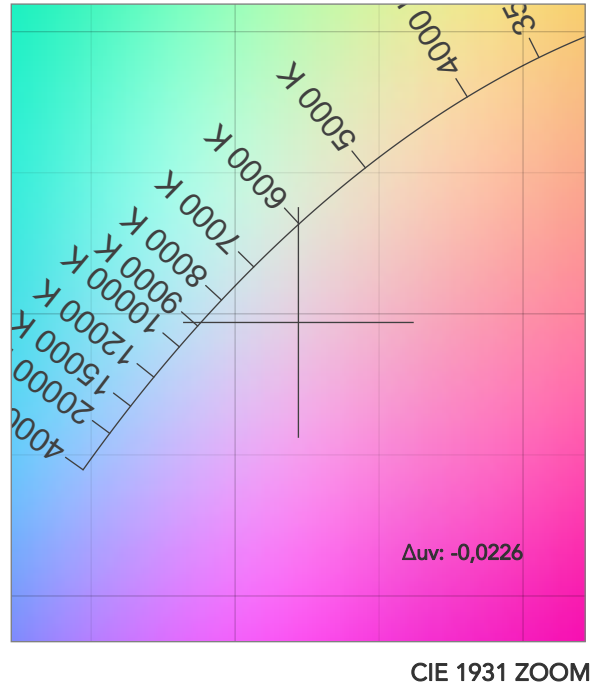
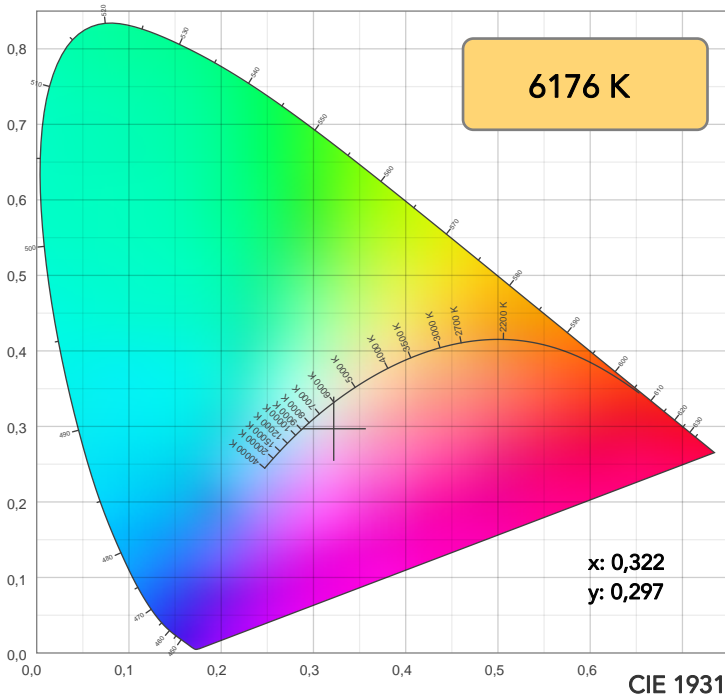

TM30: 73,5

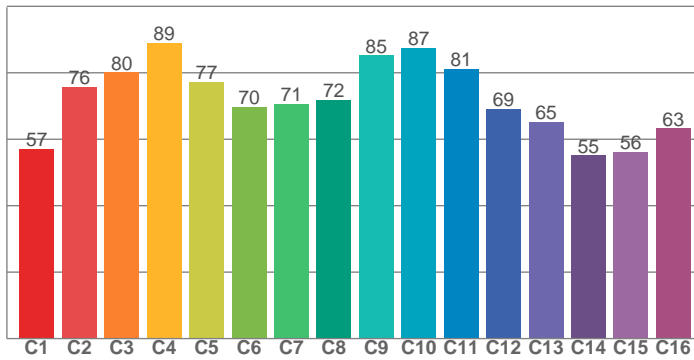

CRI: 59,6 (R1-R8)

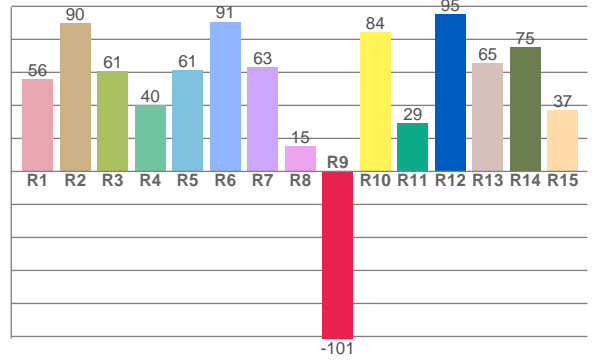

CQS: 82,6

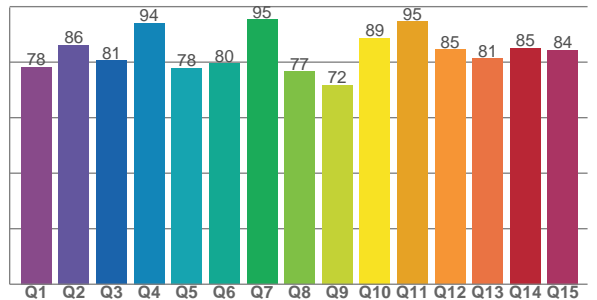

CRI R values, only R1-R8 are used to calculate final CRI value

R1	R2	R3	R4	R5	R6	R7	R8	R9	R10	R11	R12	R13	R14	R15
55,9	89,9	60,7	40,0	61,2	90,7	62,9	15,3	-101,3	84,4	29,2	95,1	65,3	75,2	37,0

TM30 C values, 16 binned values out of total of 99 C values

C1	C2	C3	C4	C5	C6	C7	C8	C9	C10	C11	C12	C13	C14	C15	C16
57,1	75,7	80,1	89,0	77,3	69,8	70,7	71,9	85,3	87,4	81,2	69,1	65,1	55,1	56,2	63,2

CQS Q values

Q1	Q2	Q3	Q4	Q5	Q6	Q7	Q8	Q9	Q10	Q11	Q12	Q13	Q14	Q15
78,3	86,2	80,5	94,2	78,0	79,5	95,3	76,7	71,8	88,8	94,6	84,6	81,3	85,1	84,4

COLOR PARAMETERS

Color temperature	Color rendering index	Red component	Color fidelity	Color gamut	Color quality scale	Television lighting index	Color coordinate cie 1931	Color coordinate cie 1931	Color deviation from black body
CCT	CRI	CRI R9	TM30 Rf	TM30 Rg	CQS	TLCI	x	y	Δuv
6176 K	59,6	-101,3	73,5	125,3	82,6	51	0,322	0,297	-0,0226

TM30 DETAILS



Rf 73,5
Fidelity index Rf

Rg 125,3
Gammut index

Hue Bin	R _f	Graphic shifts (%)	
		Chroma	Hue
1	57	23%	-2%
2	76	13%	-8%
3	80	10%	-4%
4	89	3%	6%
5	77	10%	9%
6	70	18%	12%
7	71	20%	2%
8	72	16%	-4%
9	85	9%	-9%
10	87	0%	-4%
11	81	-1%	11%
12	69	-2%	22%
13	65	4%	31%
14	55	13%	26%
15	56	31%	29%
16	63	21%	4%

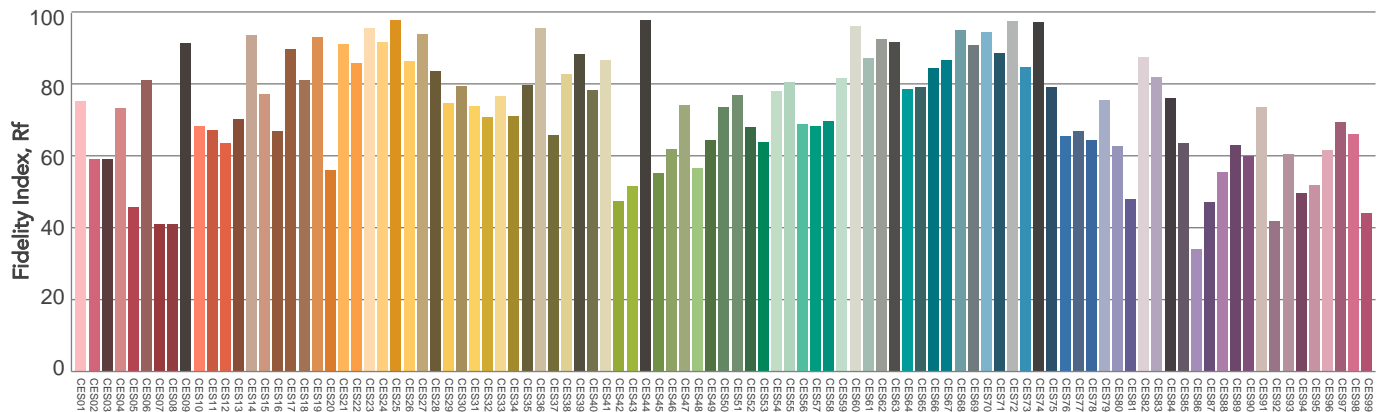
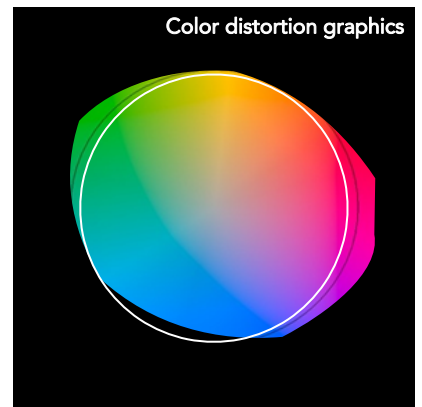
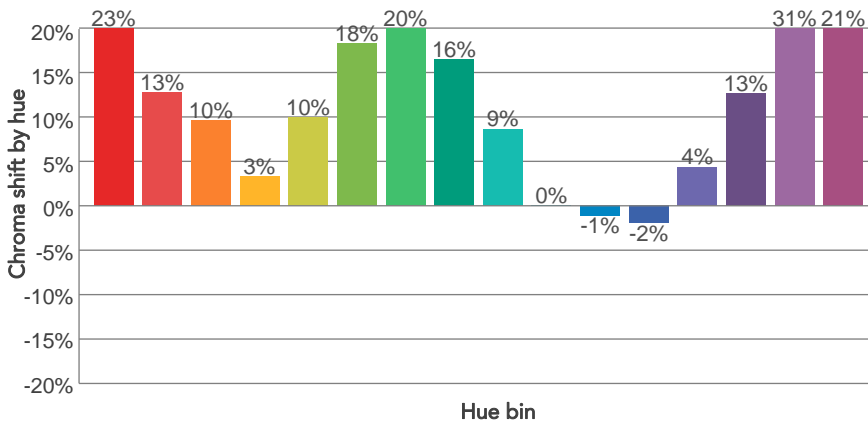
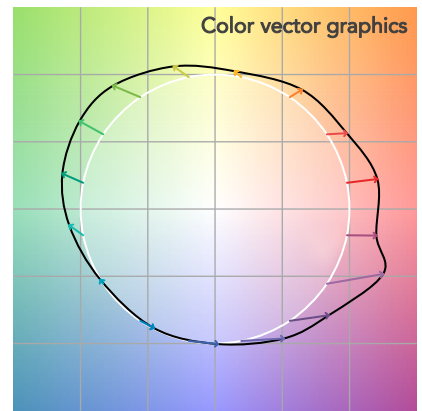
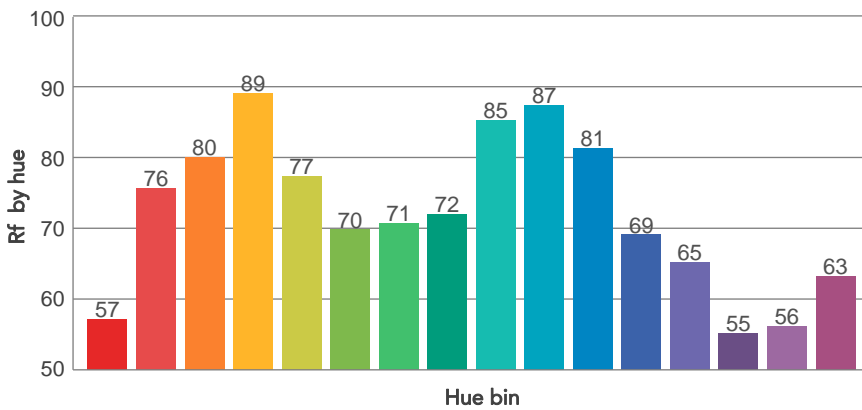
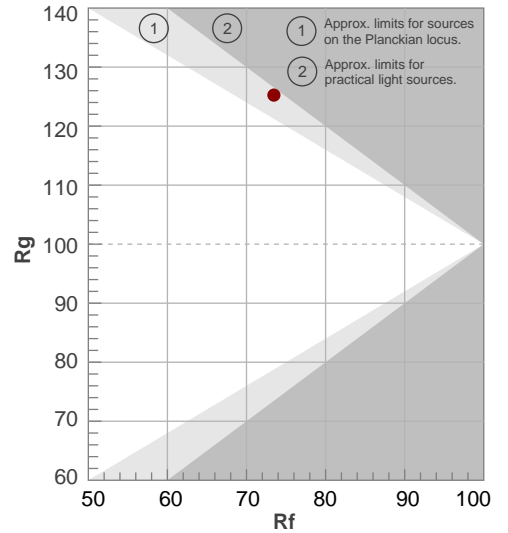

BEAM DETAILS



Beam angle 50%	Field angle 10%	Cut off angle 2,5%	Intensity ratio in 120° cone	Intensity ratio in 90° cone
38,4°	56,7°	68,2°	100,0%	100,0%

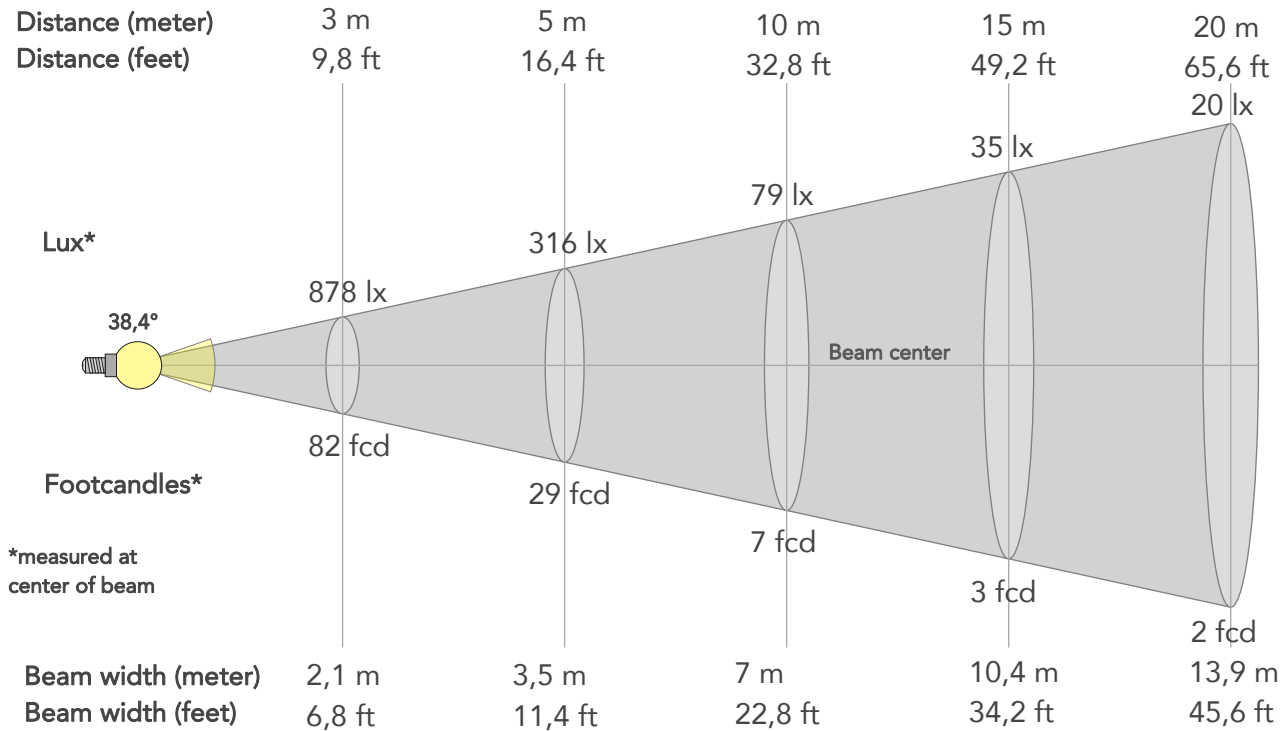

BEAM INTENSITIES AND WIDTHS

Distance	1m	2m	3m	4m	5m	7,5m	10m	15m	20m	25m	30m	40m	50m
Distance	3,3ft	6,6ft	9,8ft	13,1ft	16,4ft	24,6ft	32,8ft	49,2ft	65,6ft	82ft	98,4ft	131,2ft	164ft
Lux	7904lx	1976lx	878lx	494lx	316lx	141lx	79lx	35lx	20lx	13lx	9lx	5lx	3lx
Footcand.	734fcd	184fcd	82fcd	46fcd	29fcd	13fcd	7fcd	3fcd	2fcd	1fcd	1fcd	0fcd	0fcd
Beam wid.	0,7m	1,4m	2,1m	2,8m	3,5m	5,2m	7m	10,4m	13,9m	17,4m	20,9m	27,8m	34,8m
Beam wid.	2,3ft	4,6ft	6,8ft	9,1ft	11,4ft	17,1ft	22,8ft	34,2ft	45,6ft	57ft	68,4ft	91,3ft	114,1ft

LINEAR DISTRIBUTION DIAGRAM

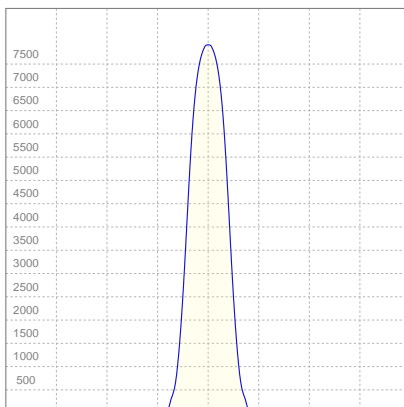

ELECTRICAL SPECIFICATIONS

Input voltage	Input current	Input power	Effeciency
222V	0,865A	174,3W	18lm/W

ISO CANDELA DIAGRAM

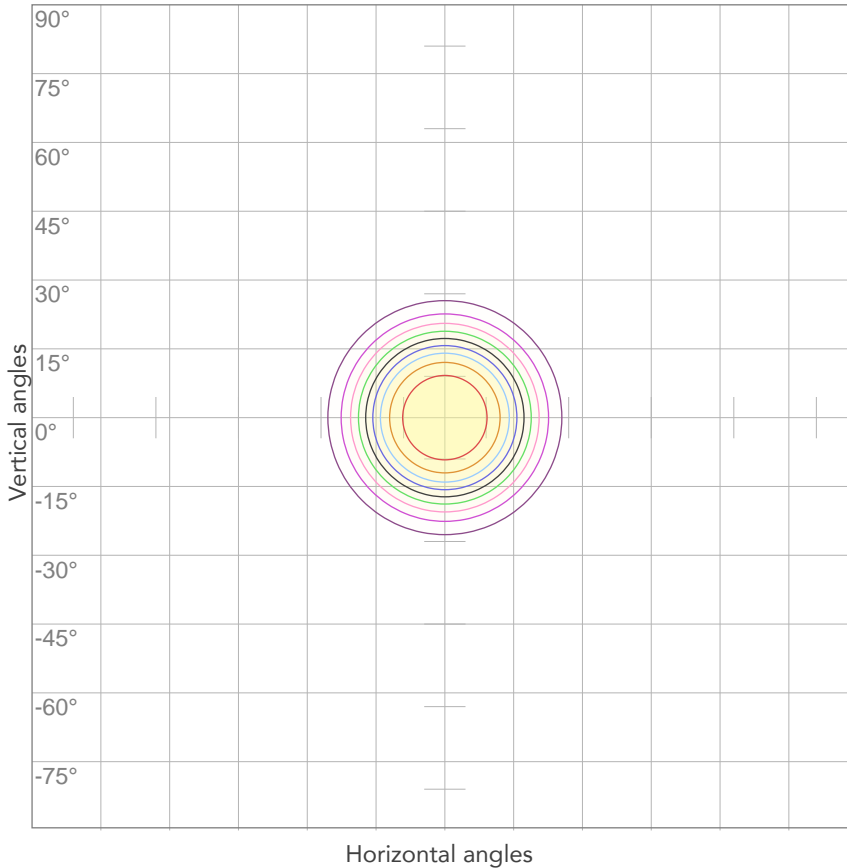

10%	790 cd
20%	1581 cd
30%	2371 cd
40%	3162 cd
50%	3952 cd
60%	4743 cd
70%	5533 cd
80%	6323 cd

Conditions:

Number of c-planes: 2

Candela at center: 7904 cd

ISO LUX DIAGRAM

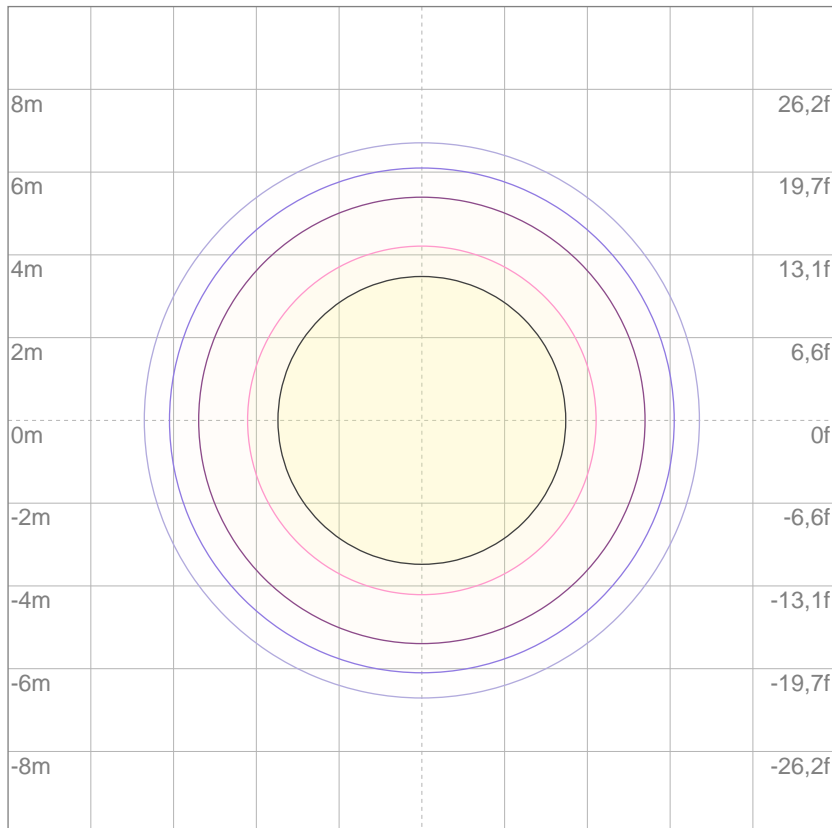

3%	2,37 lx
5%	3,95 lx
10%	7,90 lx
30%	23,7 lx
50%	39,5 lx

Conditions:

Number of c-planes: 2

Lux at center: 79,0 lx

Lux distribution on a surface when lamp is mounted at 10 meters from the surface.

Mounting height: 10 meters (33 feet)



Total lumen output:

2732 lm

Peak candela output:

31331 cd

Light quality:

CRI: 59,0

Color temperature:

6186 K

PRODUCT NAME:

ASTRAWASH7PIXIP

MEASUREMENT CONDITIONS:

Beam angle:

Med Zoom

Target:

6000K

Operator:

Paolo Carvone

Date and time:

16/02/2021 12:17:59

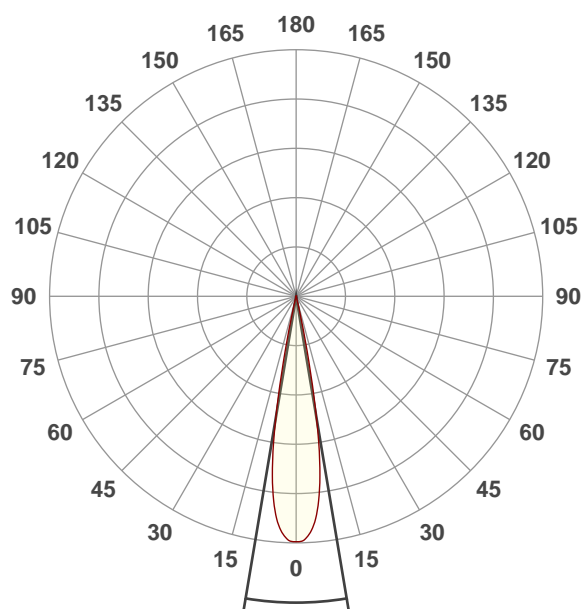

Beam angle 50%: 19°

Field angle 10%: 24,9°

Cut off angle 2.5%: 27,3°

Spectra

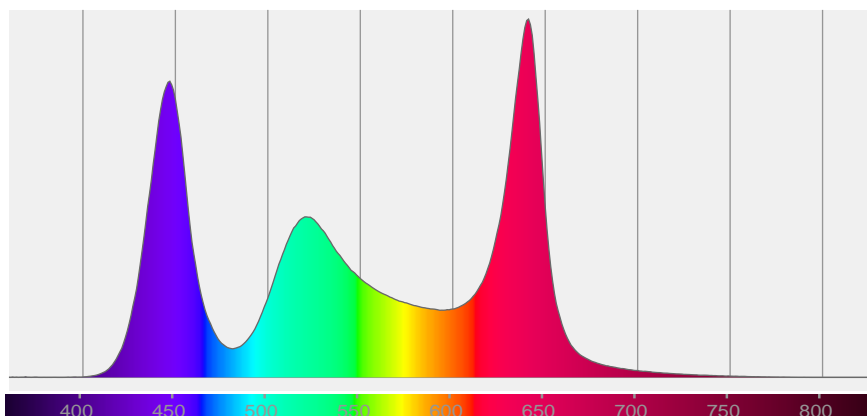

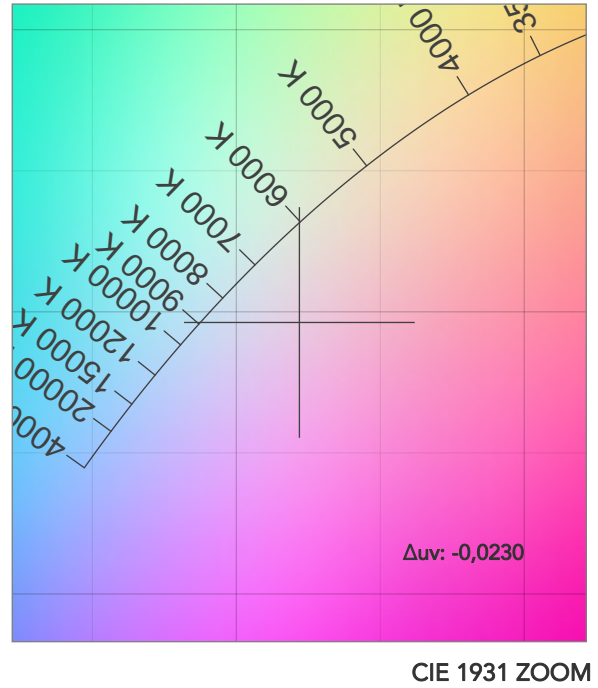
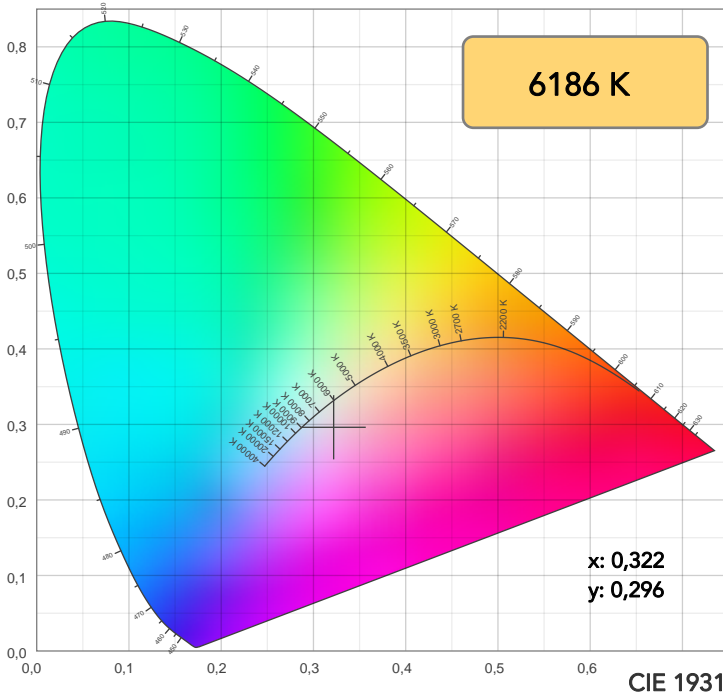

TM30: 73,2

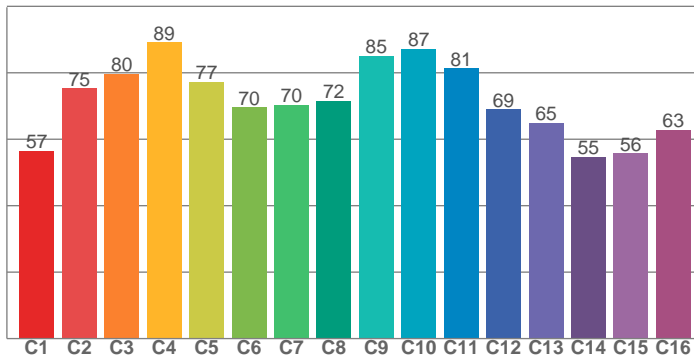

CRI: 59,0 (R1-R8)

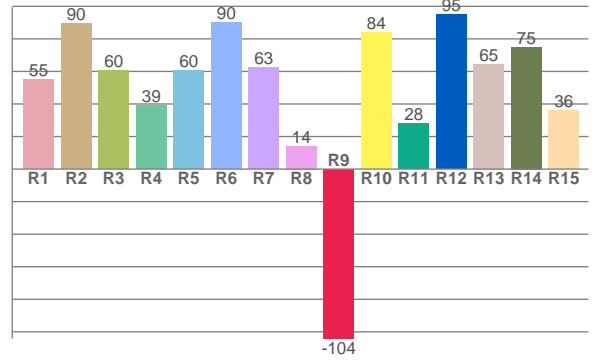

CQS: 82,4

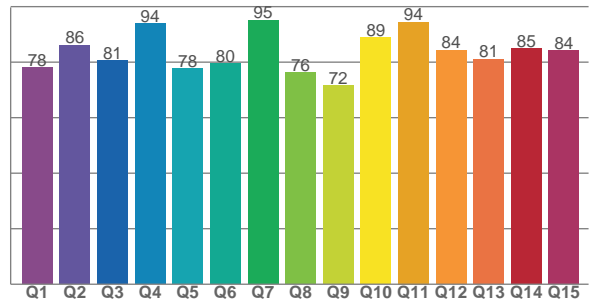

CRI R values, only R1-R8 are used to calculate final CRI value

R1	R2	R3	R4	R5	R6	R7	R8	R9	R10	R11	R12	R13	R14	R15
55,1	89,5	60,4	39,2	60,5	90,3	62,5	14,2	-104,1	83,7	28,2	94,8	64,6	75,0	35,9

TM30 C values, 16 binned values out of total of 99 C values

C1	C2	C3	C4	C5	C6	C7	C8	C9	C10	C11	C12	C13	C14	C15	C16
56,6	75,3	79,7	89,1	77,3	69,5	70,4	71,6	85,1	87,3	81,3	68,9	64,9	54,7	55,7	62,8

CQS Q values

Q1	Q2	Q3	Q4	Q5	Q6	Q7	Q8	Q9	Q10	Q11	Q12	Q13	Q14	Q15
78,0	86,1	80,6	93,9	77,8	79,5	95,1	76,3	71,6	88,8	94,4	84,3	81,0	84,9	84,1

COLOR PARAMETERS

Color temperature	Color rendering index	Red component	Color fidelity	Color gamut	Color quality scale	Television lighting index	Color coordinate cie 1931	Color coordinate cie 1931	Color deviation from black body
CCT	CRI	CRI R9	TM30 Rf	TM30 Rg	CQS	TLCI	x	y	Δuv
6186 K	59,0	-104,1	73,2	125,5	82,4	51	0,322	0,296	-0,0230

TM30 DETAILS

Rf 73,2
Fidelity index Rf

Rg 125,5
Gammut index

Hue Bin	R _f	Graphic shifts (%)	
		Chroma	Hue
1	57	23%	-2%
2	75	13%	-8%
3	80	10%	-5%
4	89	3%	6%
5	77	10%	9%
6	70	18%	12%
7	70	20%	2%
8	72	17%	-4%
9	85	9%	-9%
10	87	0%	-4%
11	81	-1%	11%
12	69	-2%	22%
13	65	4%	32%
14	55	13%	27%
15	56	31%	30%
16	63	22%	4%

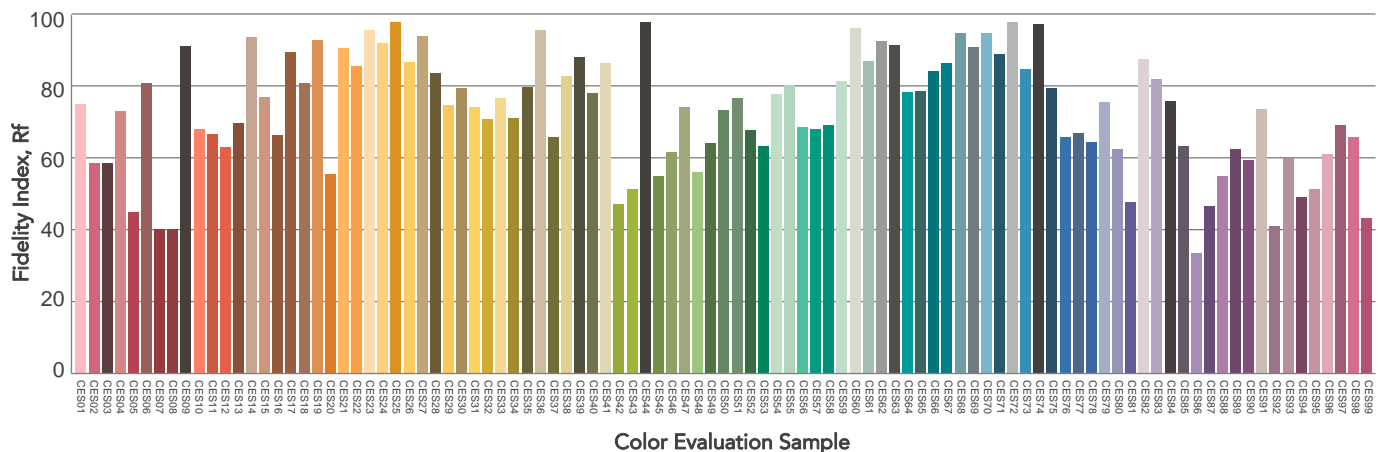
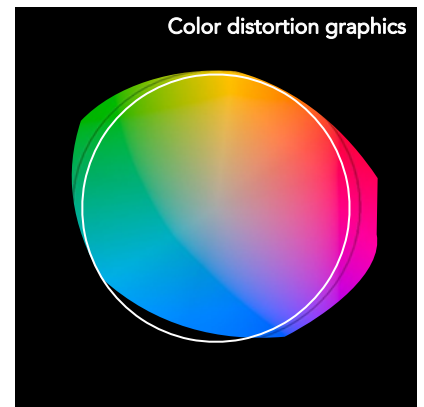
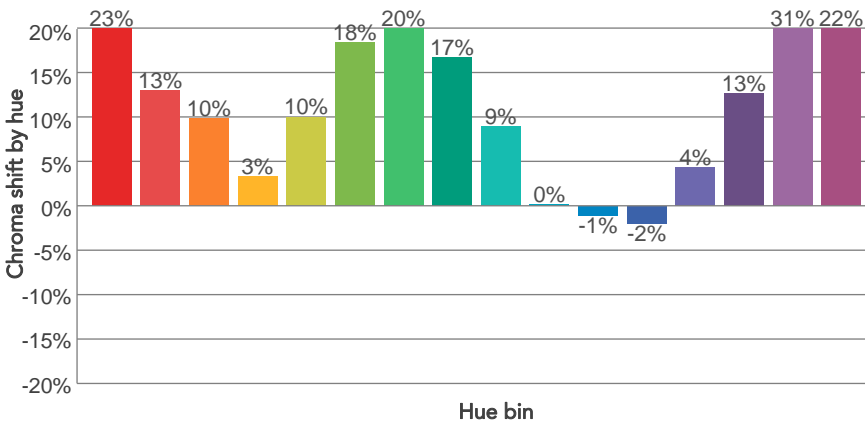
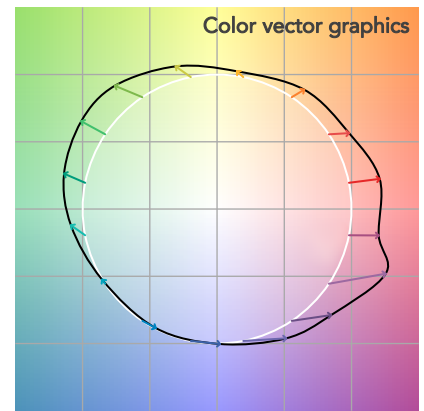
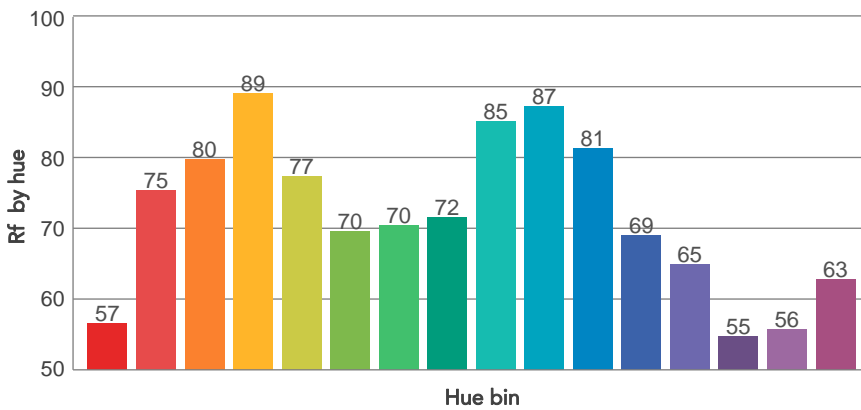
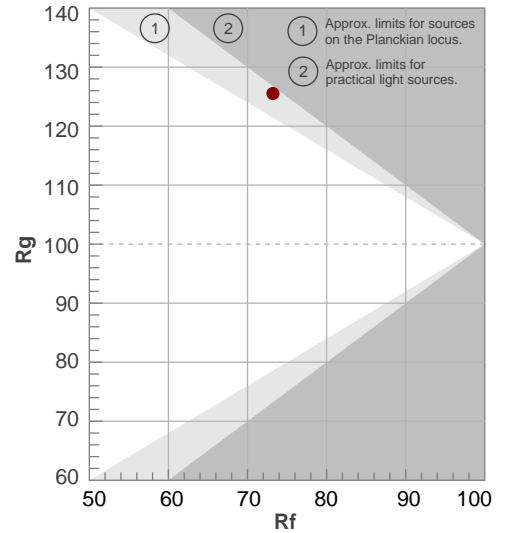

BEAM DETAILS



Beam angle 50%	Field angle 10%	Cut off angle 2,5%	Intensity ratio in 120° cone	Intensity ratio in 90° cone
19°	24,9°	27,3°	100,0%	100,0%

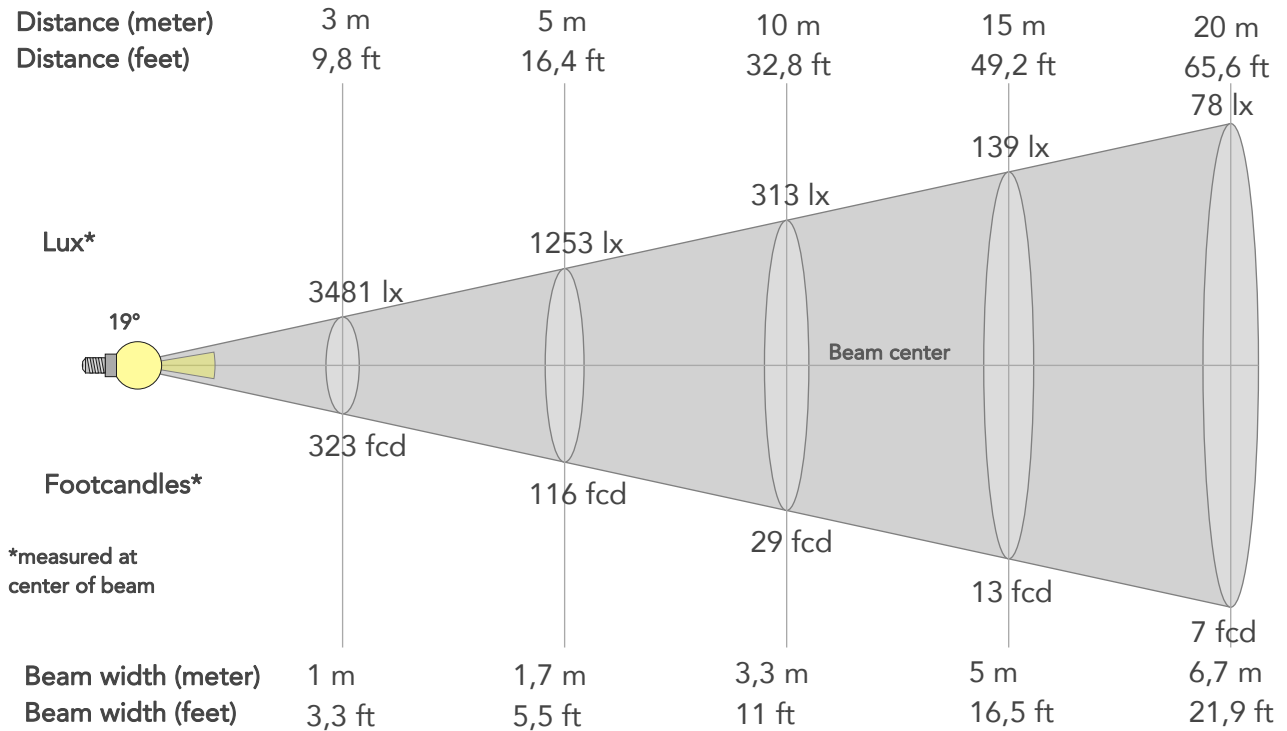

BEAM INTENSITIES AND WIDTHS

Distance	1m	2m	3m	4m	5m	7,5m	10m	15m	20m	25m	30m	40m	50m
Distance	3,3ft	6,6ft	9,8ft	13,1ft	16,4ft	24,6ft	32,8ft	49,2ft	65,6ft	82ft	98,4ft	131,2ft	164ft
Lux	31331lx	7833lx	3481lx	1958lx	1253lx	557lx	313lx	139lx	78lx	50lx	35lx	20lx	13lx
Footcand.	2911fcd	728fcd	323fcd	182fcd	116fcd	52fcd	29fcd	13fcd	7fcd	5fcd	3fcd	2fcd	1fcd
Beam wid.	0,3m	0,7m	1m	1,3m	1,7m	2,5m	3,3m	5m	6,7m	8,4m	10m	13,4m	16,7m
Beam wid.	1,1ft	2,2ft	3,3ft	4,4ft	5,5ft	8,2ft	11ft	16,5ft	21,9ft	27,4ft	32,9ft	43,9ft	54,9ft

LINEAR DISTRIBUTION DIAGRAM

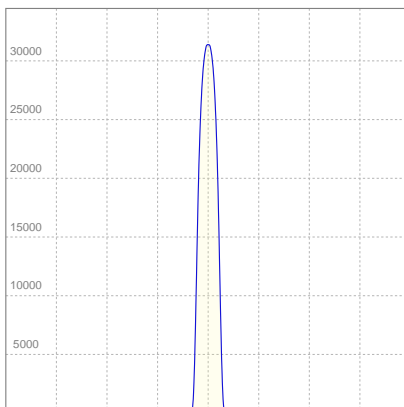

ELECTRICAL SPECIFICATIONS

Input voltage	Input current	Input power	Effeciency
223V	0,865A	174,3W	16lm/W

ISO CANDELA DIAGRAM

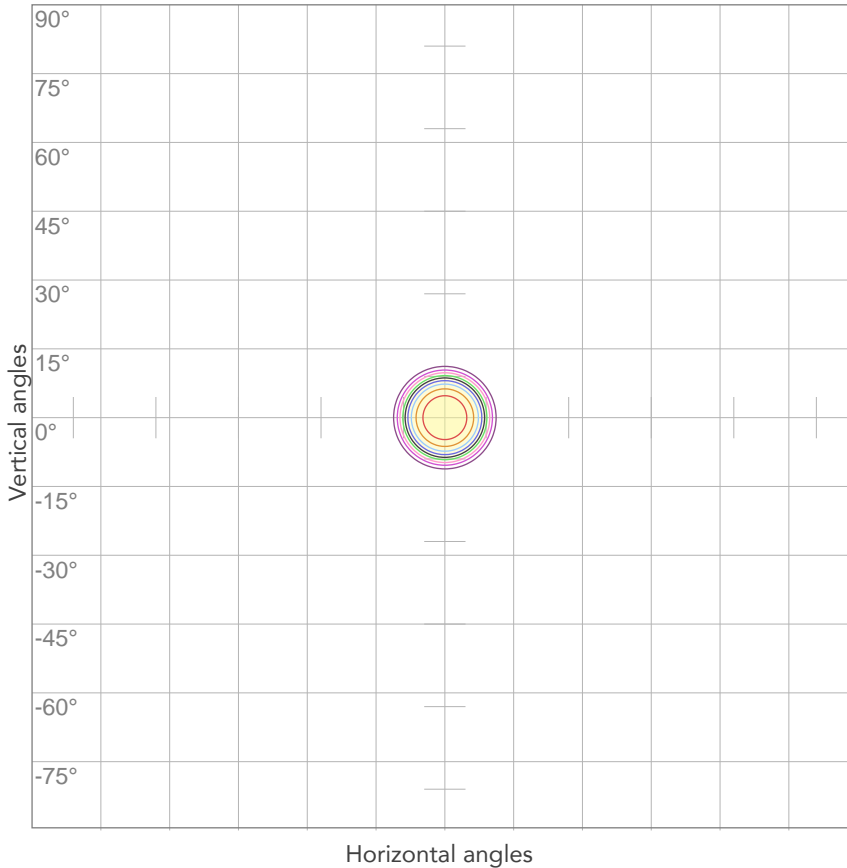

10%	3133 cd
20%	6266 cd
30%	9399 cd
40%	12532 cd
50%	15665 cd
60%	18798 cd
70%	21932 cd
80%	25065 cd

Conditions:

Number of c-planes: 2

Candela at center: 31331 cd

ISO LUX DIAGRAM

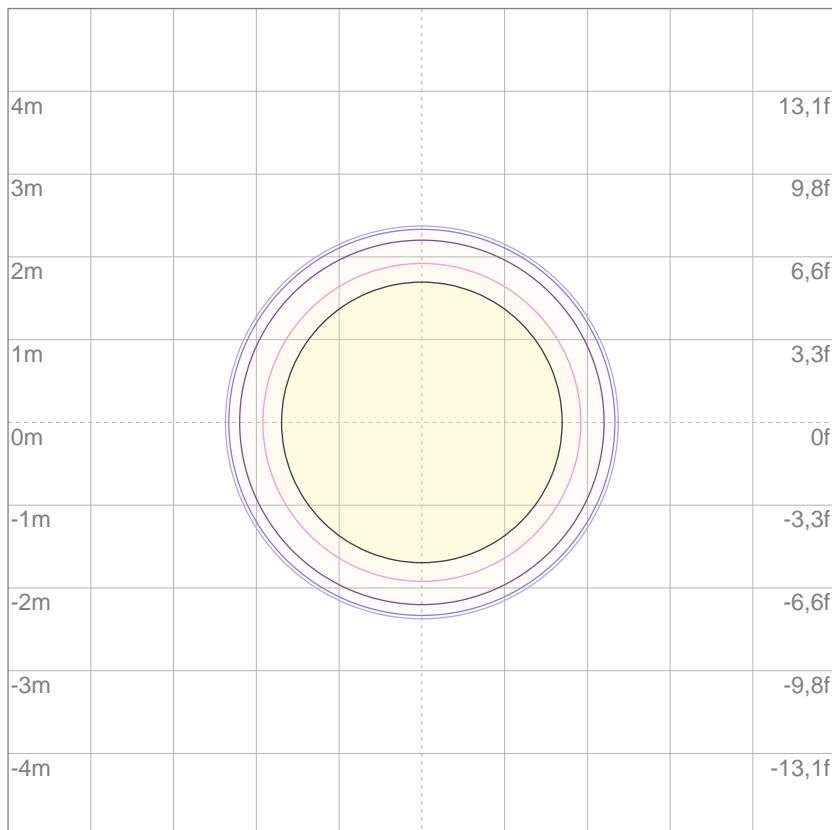

3%	9,40 lx
5%	15,7 lx
10%	31,3 lx
30%	94,0 lx
50%	157 lx

Conditions:

Number of c-planes: 2

Lux at center: 313 lx

Lux distribution on a surface when lamp is mounted at 10 meters from the surface.

Mounting height: 10 meters (33 feet)



Total lumen output:

1813 lm

Peak candela output:

396360 cd

Light quality:

CRI: 57,5

Color temperature:

6097 K

PRODUCT NAME:

ASTRAWASH7PIXIP

MEASUREMENT CONDITIONS:

Beam angle:

Min Zoom

Target:

6000K

Operator:

Paolo Carvone

Date and time:

16/02/2021 12:15:43

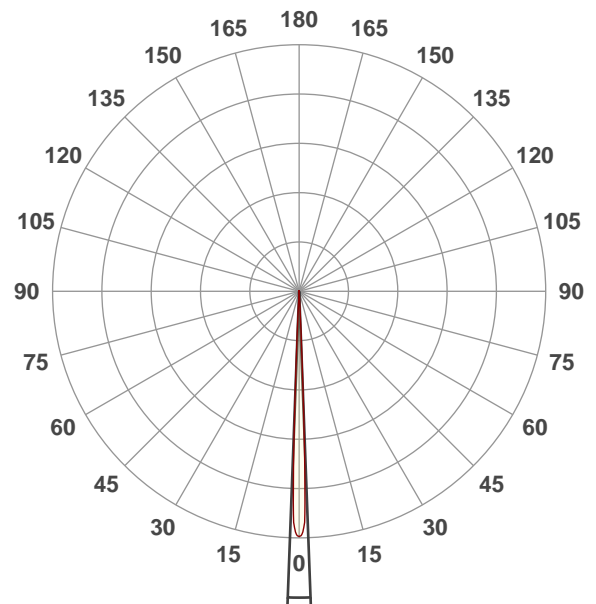

Beam angle 50%: 4,3°

Field angle 10%: 5,6°

Cut off angle 2.5%: 6,4°

Spectra

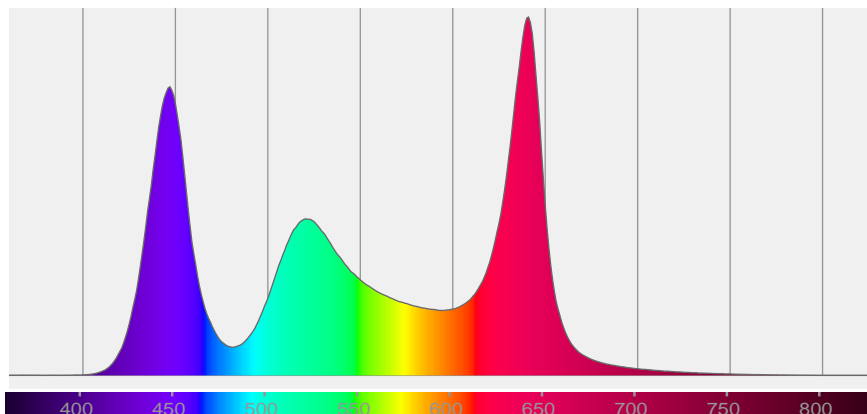

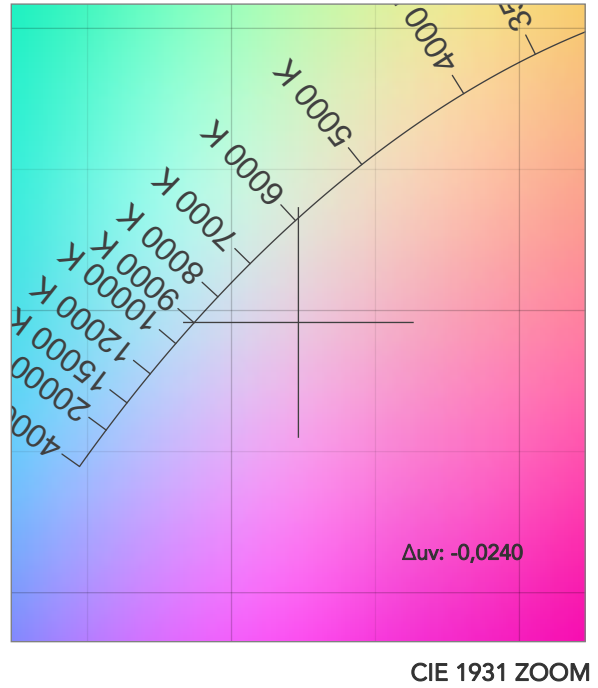
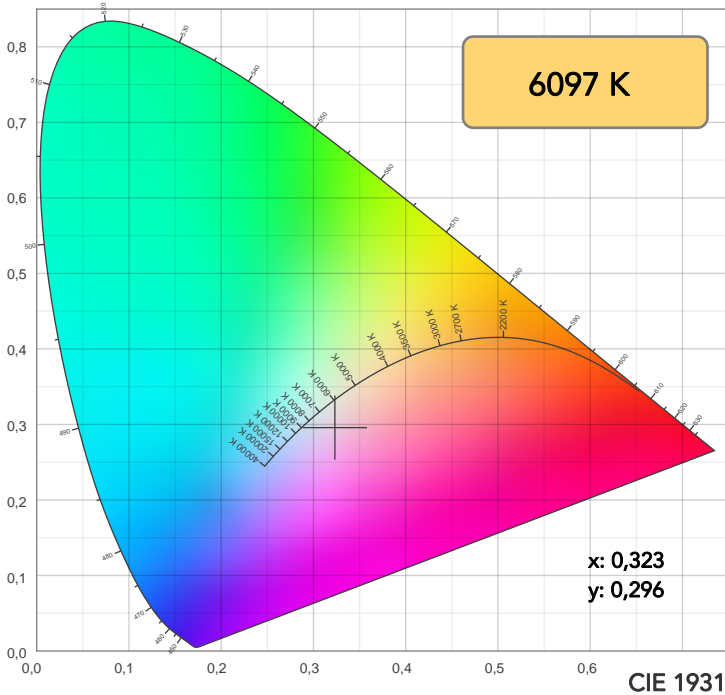

TM30: 72,8

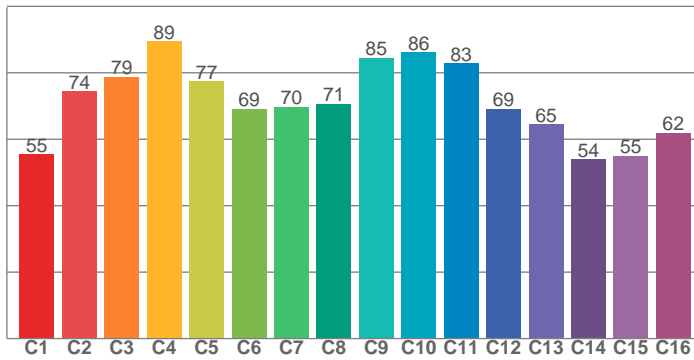

CRI: 57,5 (R1-R8)

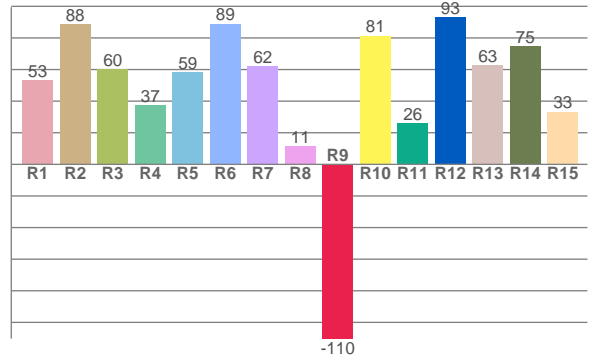

CQS: 82,0

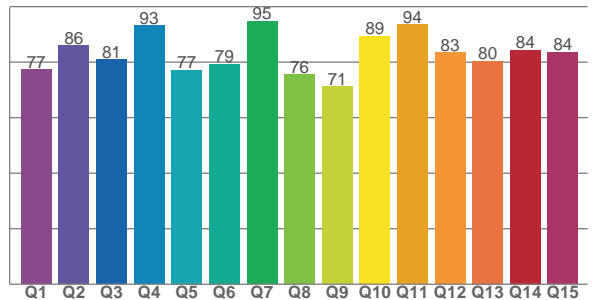

CRI R values, only R1-R8 are used to calculate final CRI value

R1	R2	R3	R4	R5	R6	R7	R8	R9	R10	R11	R12	R13	R14	R15
53,0	88,4	60,4	37,5	58,5	88,9	61,9	11,3	-110,3	81,4	26,0	93,3	62,6	74,8	33,3

TM30 C values, 16 binned values out of total of 99 C values

C1	C2	C3	C4	C5	C6	C7	C8	C9	C10	C11	C12	C13	C14	C15	C16
55,4	74,4	78,7	89,4	77,4	69,1	69,8	70,7	84,5	86,2	82,8	69,1	64,5	54,0	54,9	61,9

CQS Q values

Q1	Q2	Q3	Q4	Q5	Q6	Q7	Q8	Q9	Q10	Q11	Q12	Q13	Q14	Q15
77,3	85,9	80,9	93,1	77,1	79,3	94,7	75,6	71,2	89,3	93,6	83,5	80,5	84,4	83,5

COLOR PARAMETERS

Color temperature	Color rendering index	Red component	Color fidelity	Color gamut	Color quality scale	Television lighting index	Color coordinate cie 1931	Color coordinate cie 1931	Color deviation from black body
CCT	CRI	CRI R9	TM30 Rf	TM30 Rg	CQS	TLCI	x	y	Δuv
6097 K	57,5	-110,3	72,8	126,1	82,0	49	0,323	0,296	-0,0240

TM30 DETAILS

Rf 72,8
Fidelity index Rf

Rg 126,1
Gammut index

Hue Bin	R _f	Graphic shifts (%)	
		Chroma	Hue
1	55	24%	-2%
2	74	13%	-8%
3	79	10%	-5%
4	89	3%	5%
5	77	10%	9%
6	69	19%	13%
7	70	21%	2%
8	71	17%	-3%
9	85	10%	-10%
10	86	1%	-6%
11	83	-1%	10%
12	69	-2%	22%
13	65	4%	32%
14	54	13%	27%
15	55	31%	30%
16	62	22%	5%

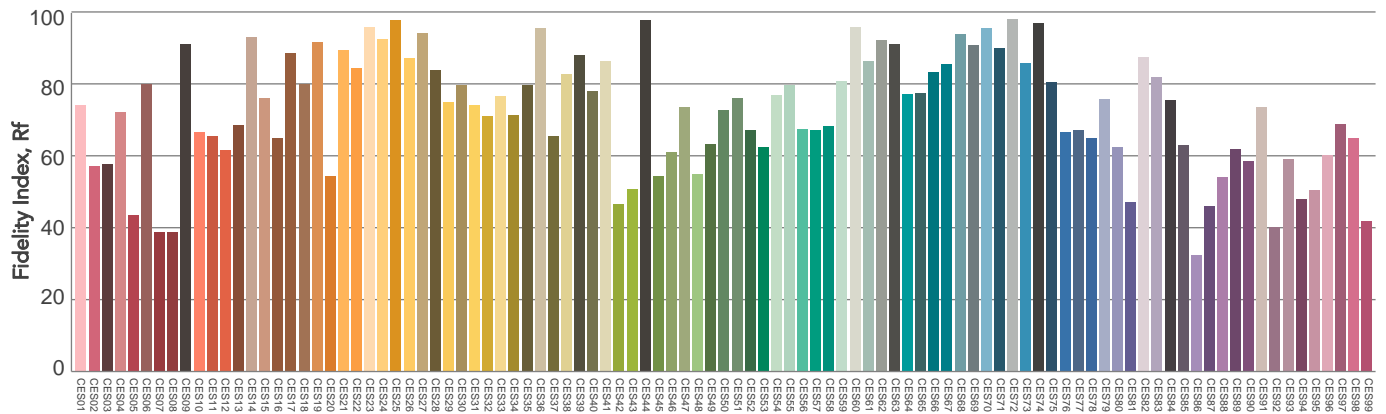
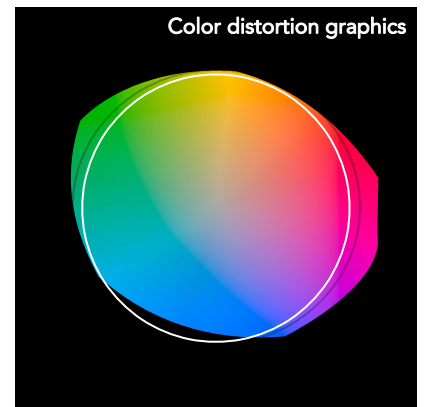
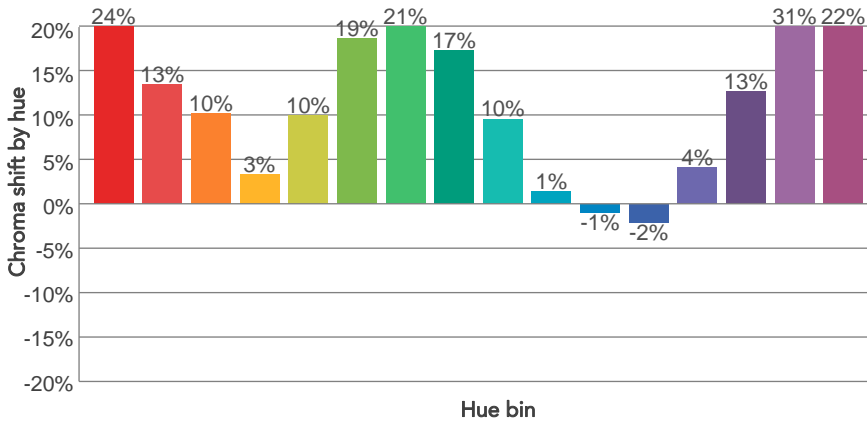
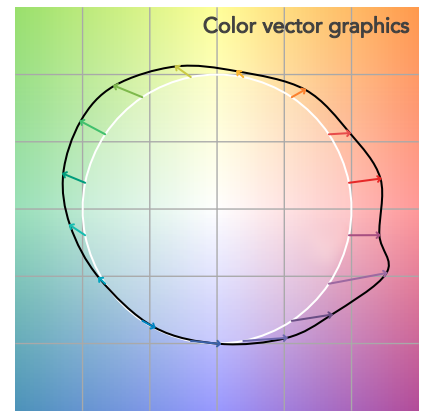
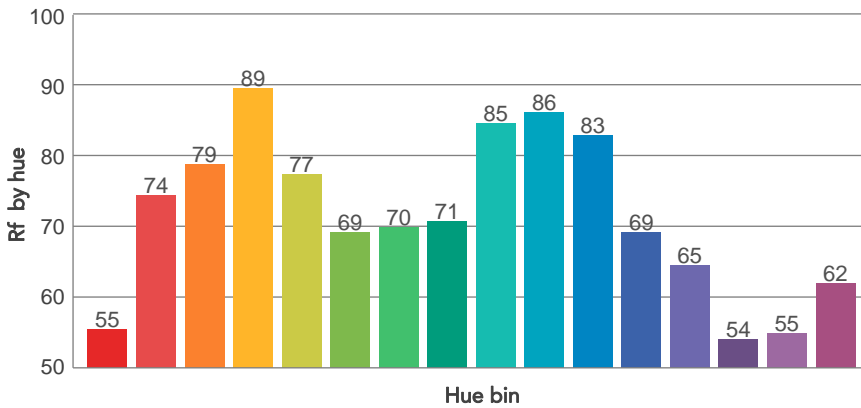
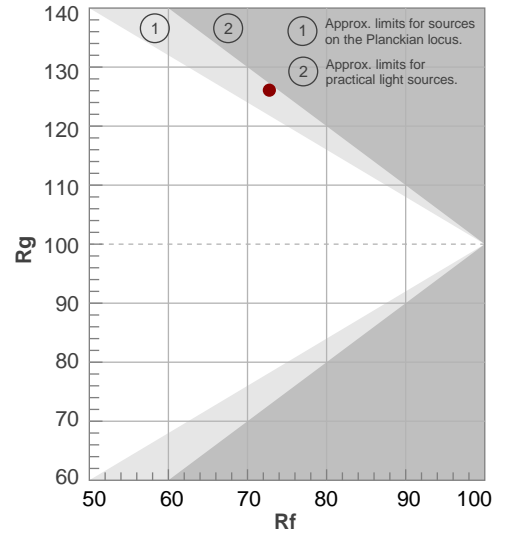

Color Evaluation Sample

BEAM DETAILS



Beam angle 50%	Field angle 10%	Cut off angle 2,5%	Intensity ratio in 120° cone	Intensity ratio in 90° cone
4,3°	5,6°	6,4°	100,0%	100,0%

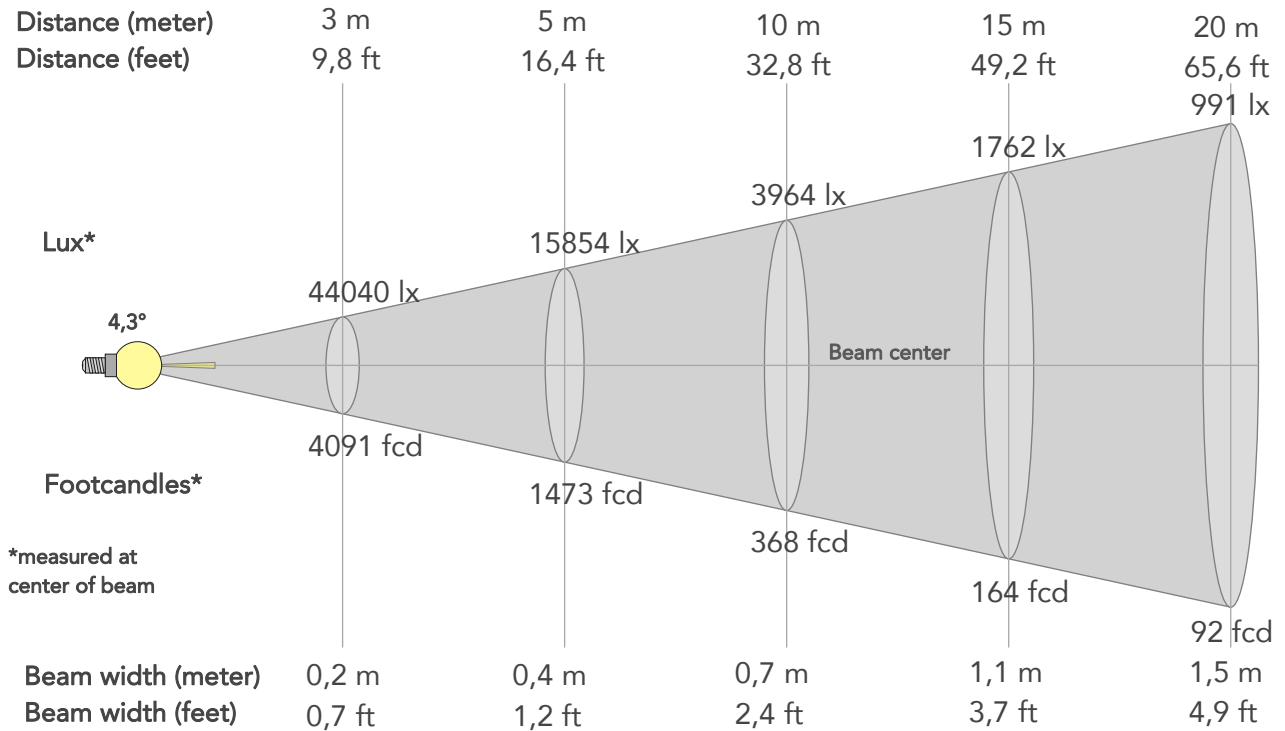

BEAM INTENSITIES AND WIDTHS

Distance	1m	2m	3m	4m	5m	7,5m	10m	15m	20m	25m	30m	40m	50m
Distance	3,3ft	6,6ft	9,8ft	13,1ft	16,4ft	24,6ft	32,8ft	49,2ft	65,6ft	82ft	98,4ft	131,2ft	164ft
Lux	396360lx	99090lx	44040lx	24773lx	15854lx	7046lx	3964lx	1762lx	991lx	634lx	440lx	248lx	159lx
Footcand.	36823fcd	9206fcd	4091fcd	2301fcd	1473fcd	655fcd	368fcd	164fcd	92fcd	59fcd	41fcd	23fcd	15fcd
Beam wid.	0,1m	0,1m	0,2m	0,3m	0,4m	0,6m	0,7m	1,1m	1,5m	1,9m	2,2m	3m	3,7m
Beam wid.	0,2ft	0,5ft	0,7ft	1ft	1,2ft	1,8ft	2,4ft	3,7ft	4,9ft	6,1ft	7,3ft	9,8ft	12,2ft

LINEAR DISTRIBUTION DIAGRAM

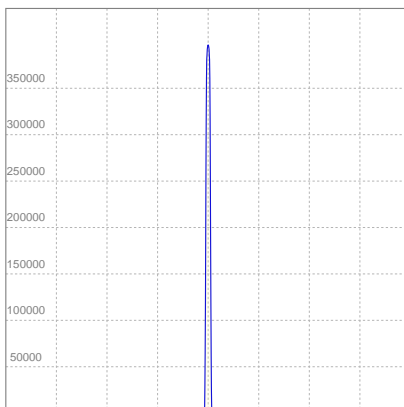

ELECTRICAL SPECIFICATIONS

Input voltage	Input current	Input power	Effeciency
222V	0,864A	174W	10lm/W

ISO CANDELA DIAGRAM

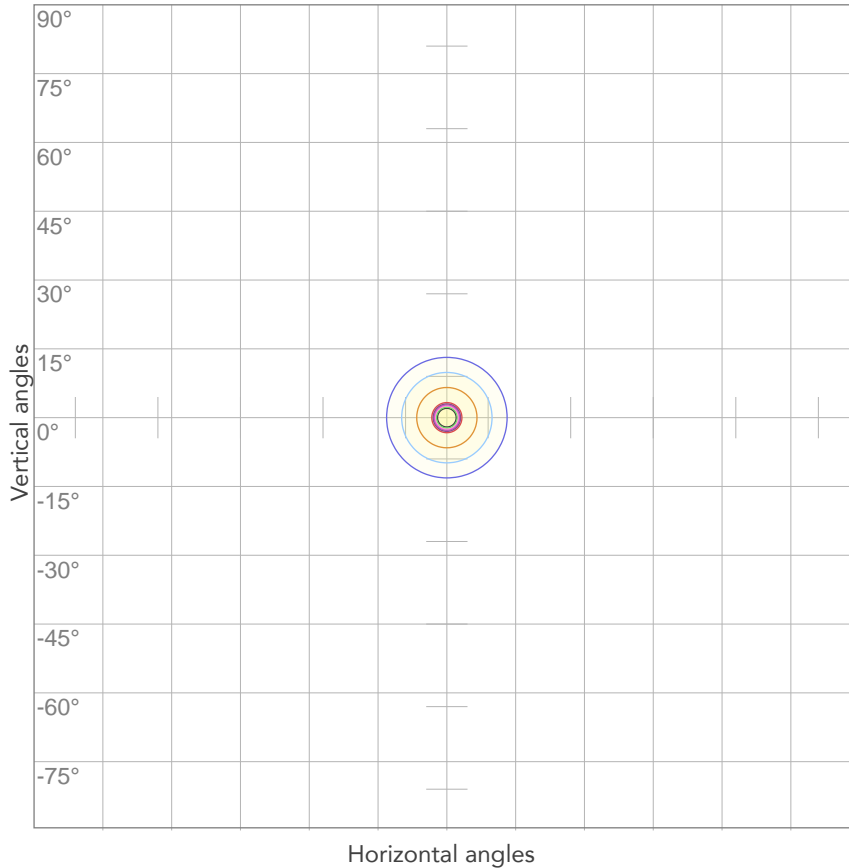

10%	39636 cd
20%	79272 cd
30%	118908 cd
40%	158544 cd
50%	198180 cd
60%	237816 cd
70%	277452 cd
80%	317088 cd

Conditions:

Number of c-planes: 2

Candela at center: 396360 cd

ISO LUX DIAGRAM

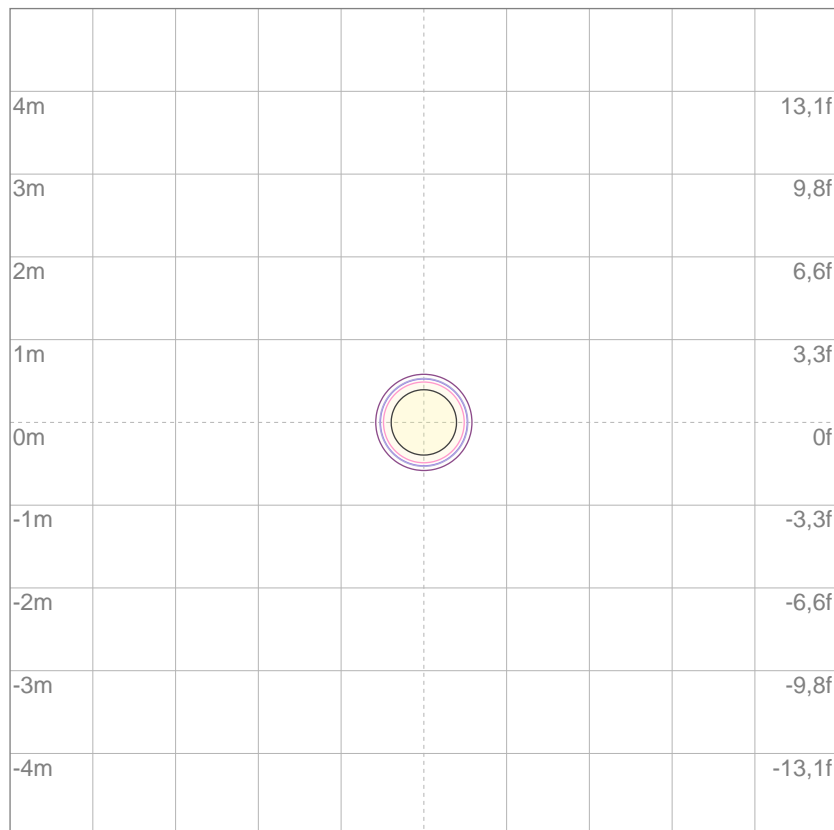

3%	119 lx
5%	198 lx
10%	396 lx
30%	1189 lx
50%	1982 lx

Conditions:

Number of c-planes: 2

Lux at center: 3964 lx

Lux distribution on a surface when lamp is mounted at 10 meters from the surface.

Mounting height: 10 meters (33 feet)