

Photometric Test Report



EclipseFresnel DY

Cold White LED Fresnel Luminaire

CONTENTS

Table of contents	2
Testing process	2
Color preset Full on	
Beam angle 45°	3
Beam angle 30°	8
Beam angle 15°	13

TESTING PROCESS

Prolights has its own optical testing laboratory in order to provide accurate photometric reports for its lighting products. The testing laboratory contains certain variety of precise lighting measurement systems that ensure an optimal reading of all the characteristic parameters of the lighting devices. All measurements are made at a controlled room temperature of 20°C without any external light sources. This photometric report is obtained through the data measured by a high precision measurement system and analyzed by a dedicate software.

Prolights measurement instrument

Prolights measurement instrument is a complete measurement system for any light source. It's equipped with two-axis goniometer, that enables to measure the full 3D distribution field of the light source. This instrument measures the light intensity, the beam angle and the most significative colors parameters, like color temperature, spectral distribution, CRI, CQS, TM-30 with a very high accuracy rate.

Please Note: All measurements are made with light source at operating temperature. Before starting the measurement, the instrument analyzes the process of the light source during the heating phase. The measuring process of all the parameters begins only when the light emission is stable, that is with a variation of less than 0.5% in a 15 minutes time frame.

Prolights measurement software

The software provides user friendly interface for the operator who does the measurements, and it also analyzes and processes all the collected data by the instrument. With this software it is possible to see the measured data in real-time and it is possible to examine all the measured data and graphics afterwards as well. All information is collected in a specific Prolights template, and the software creates also IES and LDT files, which are widely used to transfer the photometric data, and to develop lighting system.

Additionally, the fixtures are rechecked using various hand-held instruments like Sekonic C-700 and Gossen Mavospec Base, this is done to ensure, that the data in the photometric report are as accurate as possible.



Total lumen output:

15623 lm

Total candela output:

29558 cd

Light quality:

CRI: 95,1

Color temperature:

5515 K

PRODUCT NAME:

EclipseFresnel DY

MEASUREMENT CONDITIONS:

Beam angle:

45°

Target:

5600K

Operator:

Paolo Carvone

Date and time:

22/01/2020 15:32:31

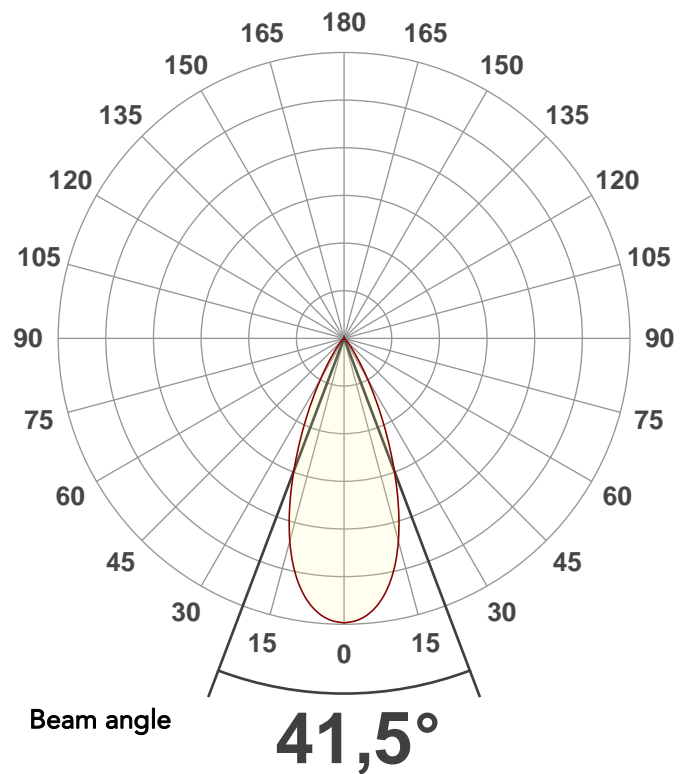

Spectra



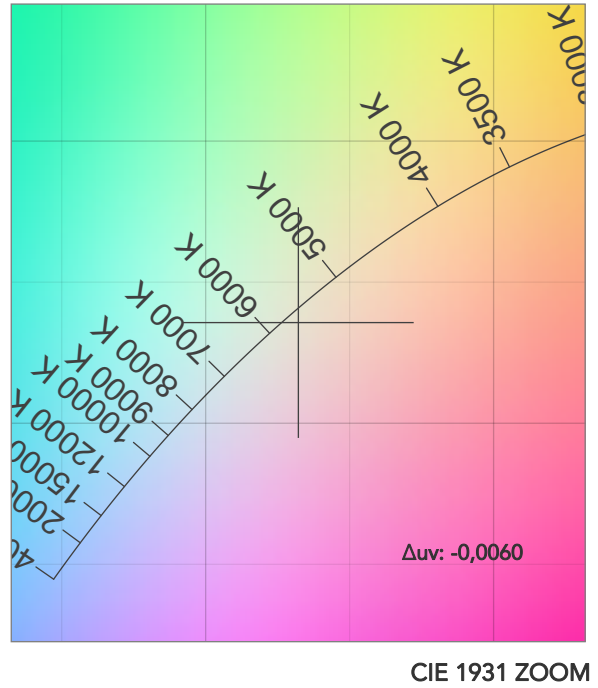
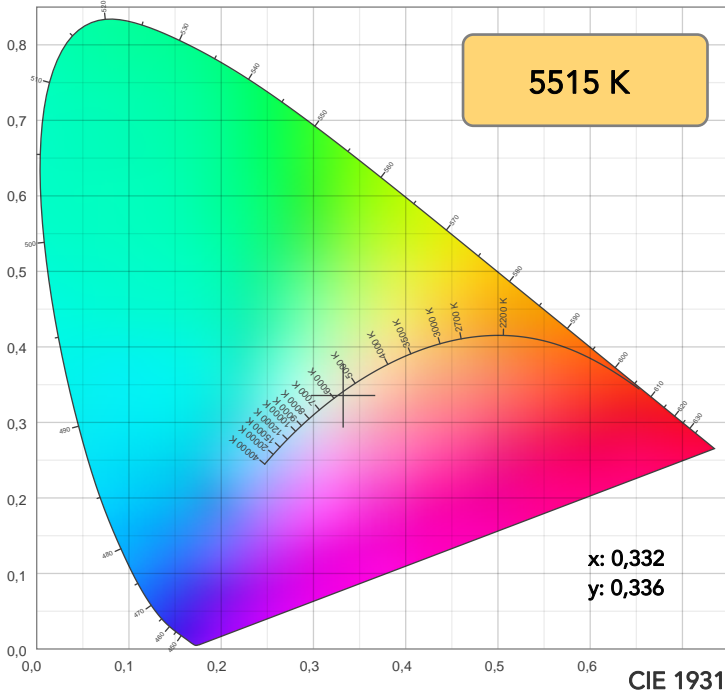

TM30: 89,2

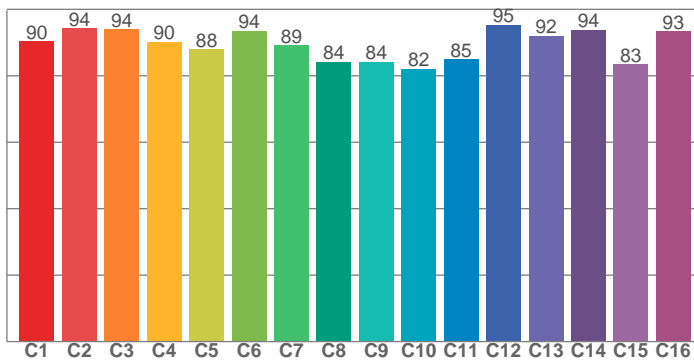

CRI: 95,1 (R1-R8)

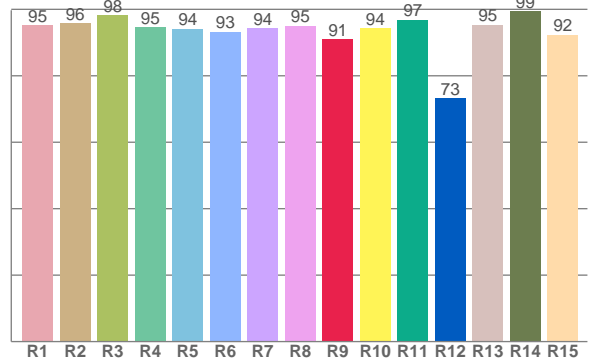

CQS: 93,1

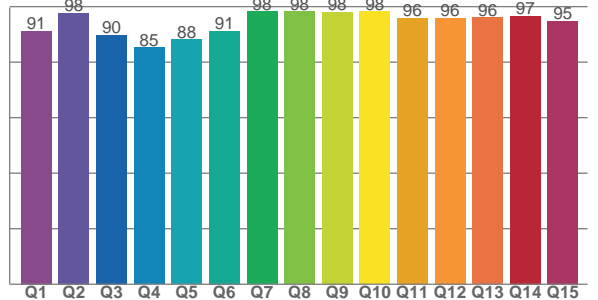

CRI R values, only R1-R8 are used to calculate final CRI value

R1	R2	R3	R4	R5	R6	R7	R8	R9	R10	R11	R12	R13	R14	R15
95,2	95,8	98,3	94,5	94,1	93,3	94,3	95,1	90,9	94,4	96,9	73,3	95,4	99,3	92,4

TM30 C values, 16 binned values out of total of 99 C values

C1	C2	C3	C4	C5	C6	C7	C8	C9	C10	C11	C12	C13	C14	C15	C16
90,4	94,2	94,0	90,3	88,0	93,6	89,2	84,3	84,2	82,0	84,9	95,3	91,9	93,9	83,4	93,4

CQS Q values

Q1	Q2	Q3	Q4	Q5	Q6	Q7	Q8	Q9	Q10	Q11	Q12	Q13	Q14	Q15
91,2	97,7	89,7	85,3	88,1	91,2	98,2	98,2	98,1	98,2	96,0	95,9	96,1	96,6	94,9

COLOR PARAMETERS

Color temperature	Color rendering index	Red component	Color fidelity	Color gamut	Color quality scale	Television lighting index	Color coordinate cie 1931	Color coordinate cie 1931	Color deviation from black body
CCT	CRI	CRI R9	TM30 Rf	TM30 Rg	CQS	TLCI	x	y	Δuv
5515 K	95,1	90,9	89,2	98,6	93,1	96	0,332	0,336	-0,0060

TM30 DETAILS

Rf 89,2
Fidelity index Rf

Rg 98,6
Gammut index

Hue Bin	R _f	Graphic shifts (%)	
		Chroma	Hue
1	90	-1%	2%
2	94	1%	1%
3	94	0%	-1%
4	90	-3%	-3%
5	88	-7%	-2%
6	94	-4%	0%
7	89	-5%	4%
8	84	-3%	8%
9	84	-1%	13%
10	82	2%	10%
11	85	5%	7%
12	95	3%	-1%
13	92	3%	-3%
14	94	-1%	-2%
15	83	7%	-8%
16	93	-2%	2%

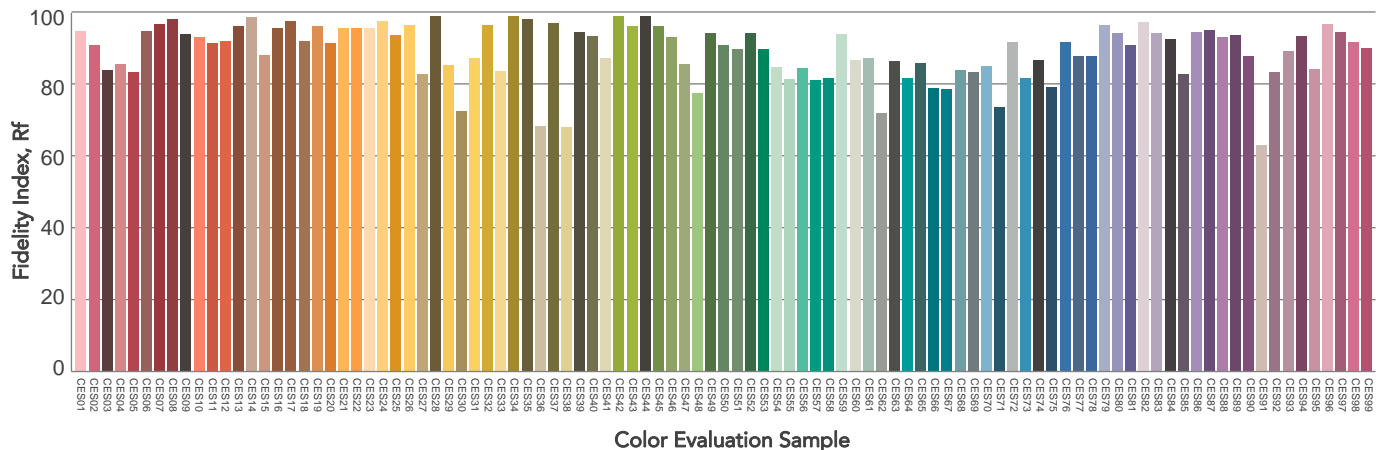
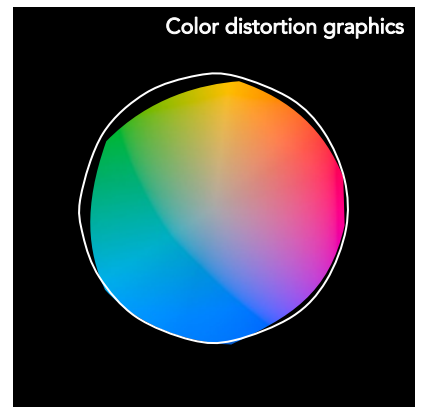
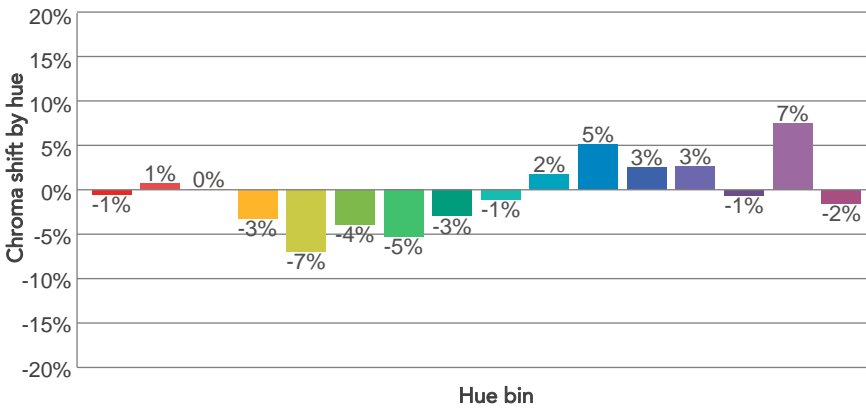
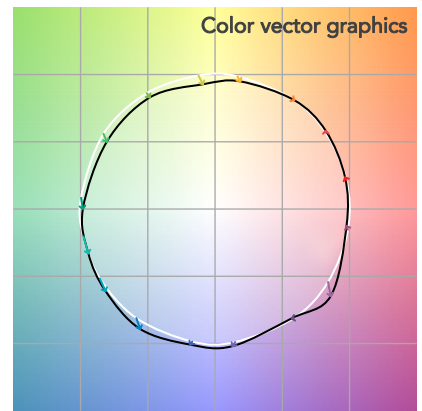
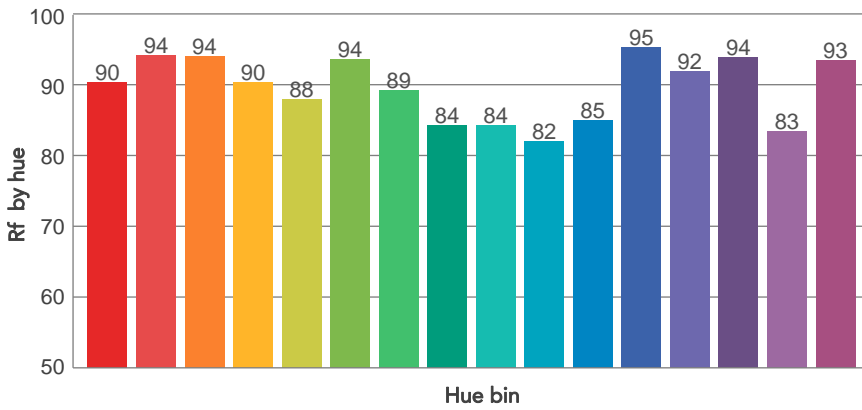
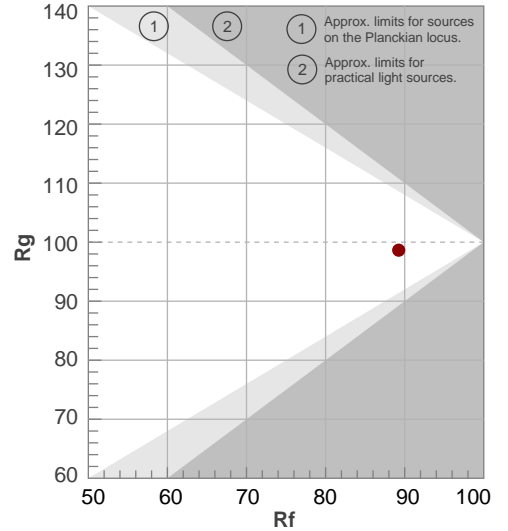

BEAM DETAILS



Beam angle 50%	Field angle 10%	Cutoff angle 2,5%	Intensity ratio in 120° cone	Intensity ratio in 90° cone
41,5°	66,2°	81,8°	95,5%	93,8%

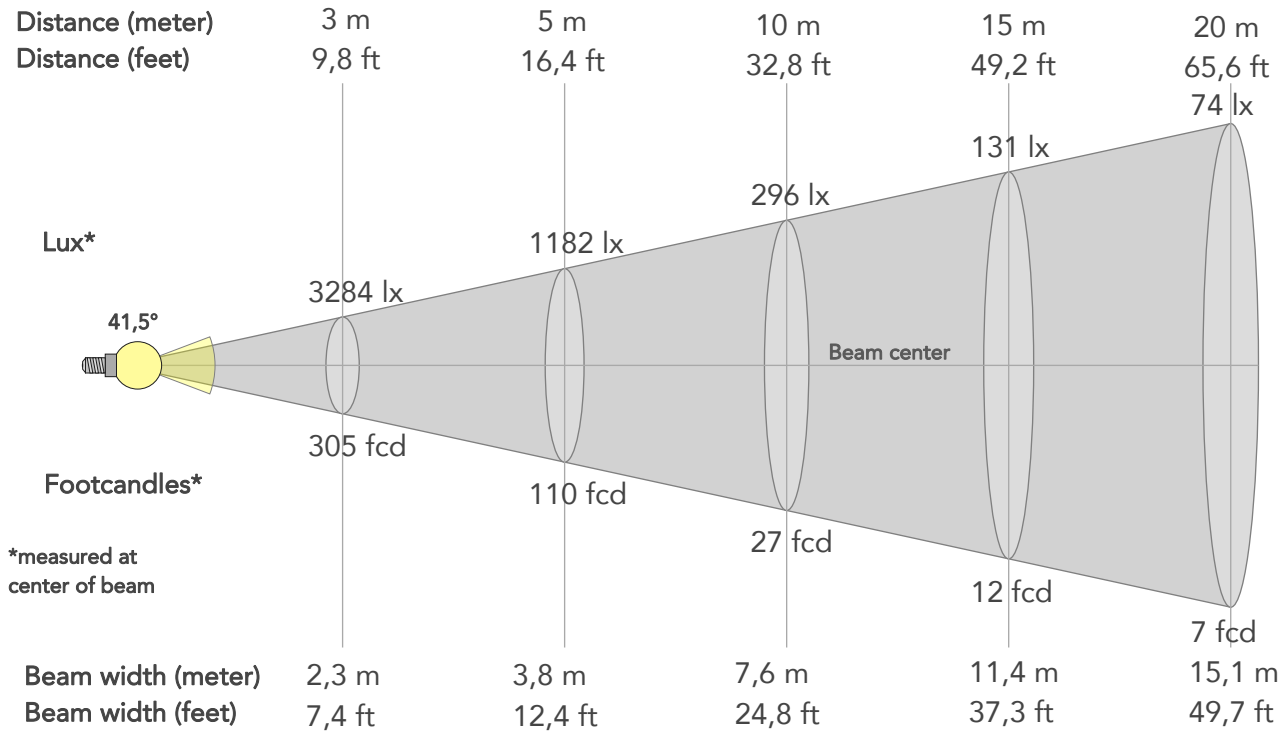

BEAM INTENSITIES AND WIDTHS

Distance	1m	2m	3m	4m	5m	7,5m	10m	15m	20m	25m	30m	40m	50m
Distance	3,3ft	6,6ft	9,8ft	13,1ft	16,4ft	24,6ft	32,8ft	49,2ft	65,6ft	82ft	98,4ft	131,2ft	164ft
Lux	29558lx	7390lx	3284lx	1847lx	1182lx	525lx	296lx	131lx	74lx	47lx	33lx	18lx	12lx
Footcand.	2746fcd	687fcd	305fcd	172fcd	110fcd	49fcd	27fcd	12fcd	7fcd	4fcd	3fcd	2fcd	1fcd
Beam wid.	0,8m	1,5m	2,3m	3m	3,8m	5,7m	7,6m	11,4m	15,1m	18,9m	22,7m	30,3m	37,9m
Beam wid.	2,5ft	5ft	7,4ft	9,9ft	12,4ft	18,6ft	24,8ft	37,3ft	49,7ft	62,1ft	74,5ft	99,4ft	124,2ft

LINEAR DISTRIBUTION DIAGRAM

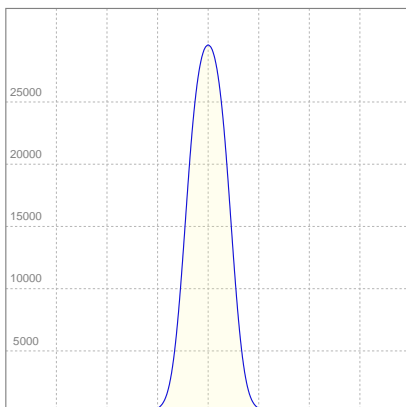

ELECTRICAL SPECIFICATIONS

Input voltage	Input current	Input power	Effeciency
223V	1,04A	217,9W	72lm/W

ISO CANDELA DIAGRAM

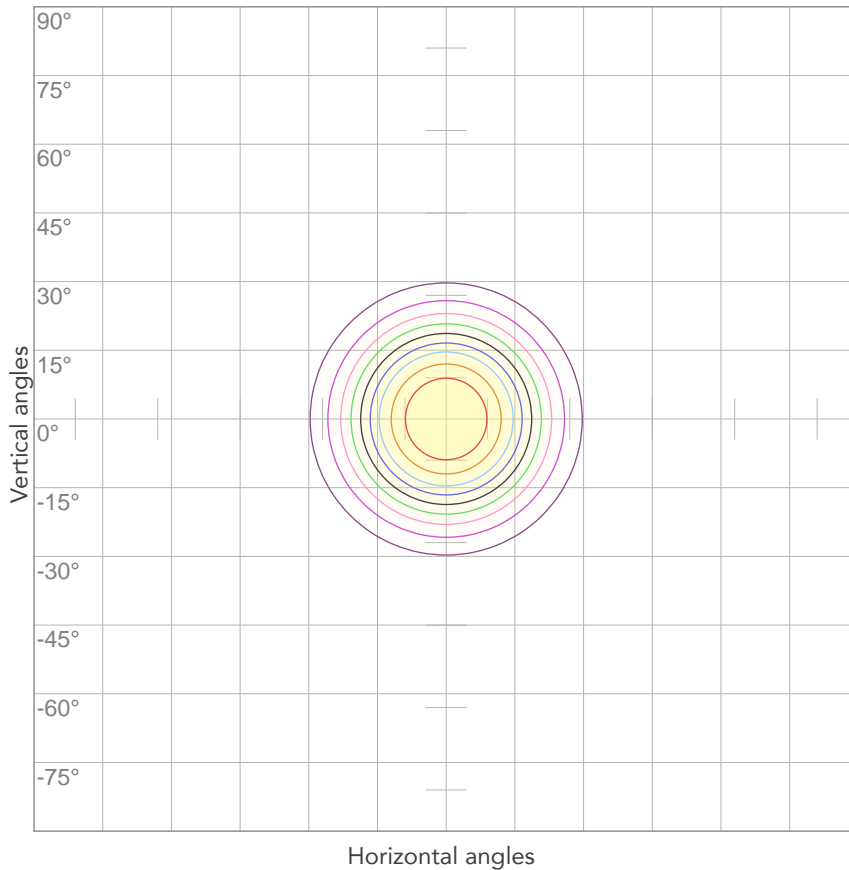

10%	2956 cd
20%	5912 cd
30%	8868 cd
40%	11823 cd
50%	14779 cd
60%	17735 cd
70%	20691 cd
80%	23647 cd

Conditions:

Number of c-planes: 2

Candela at center: 29558 cd

ISO LUX DIAGRAM

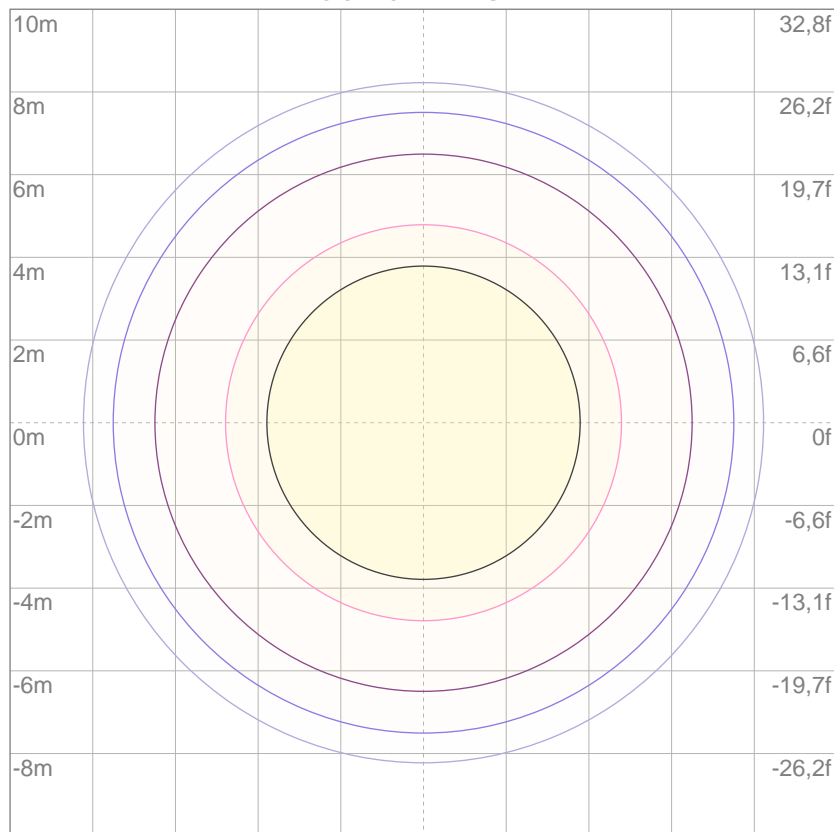

Mounting height: 10 meters (33 feet)

3%	8,87 lx
5%	14,8 lx
10%	29,6 lx
30%	88,7 lx
50%	148 lx

Conditions:

Number of c-planes: 2

Lux at center: 296 lx

Lux distribution on a surface when lamp is mounted at 10 meters from the surface.



Total lumen output:

14424 lm

Total candela output:

79683 cd

Light quality:

CRI: 95,1

Color temperature:

5567 K

PRODUCT NAME:

EclipseFresnel DY

MEASUREMENT CONDITIONS:

Beam angle:

30°

Target:

5600K

Operator:

Paolo Carvone

Date and time:

22/01/2020 15:30:26

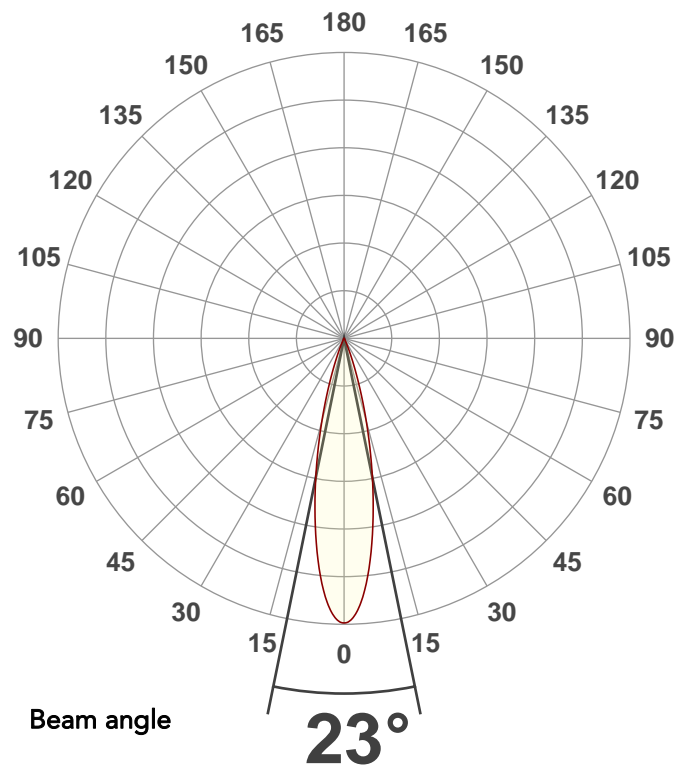

Spectra

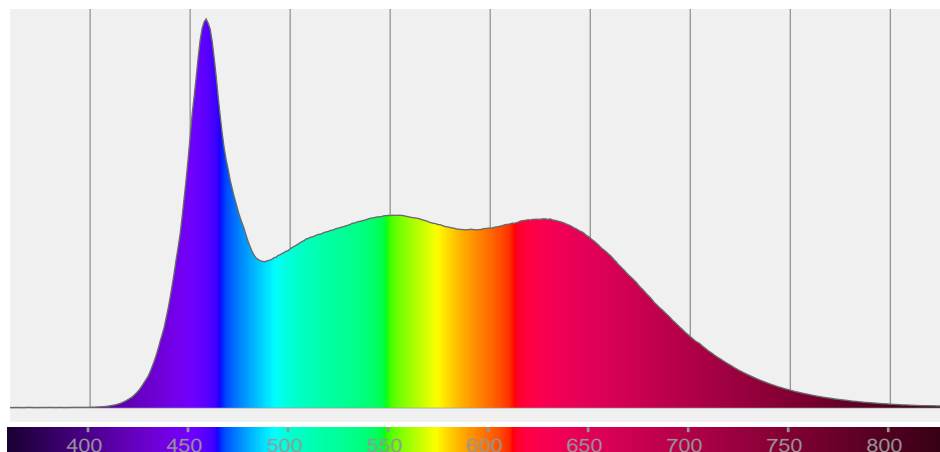

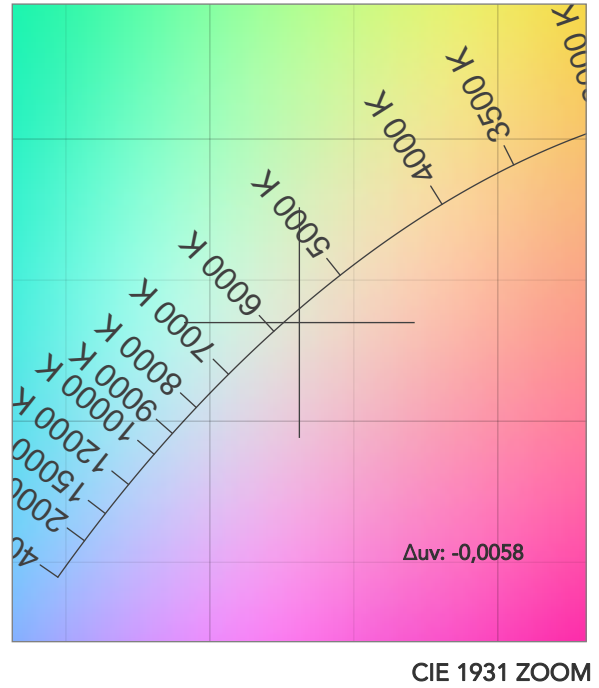
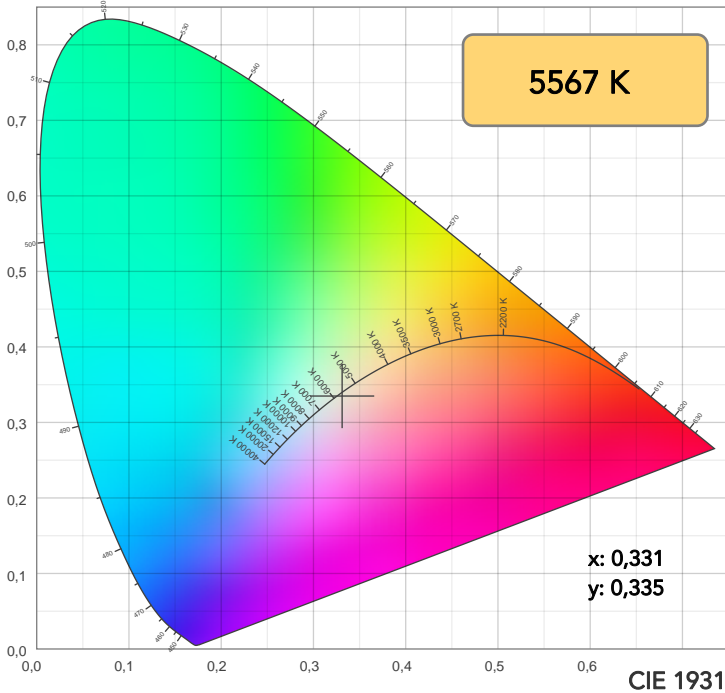

TM30: 89,2

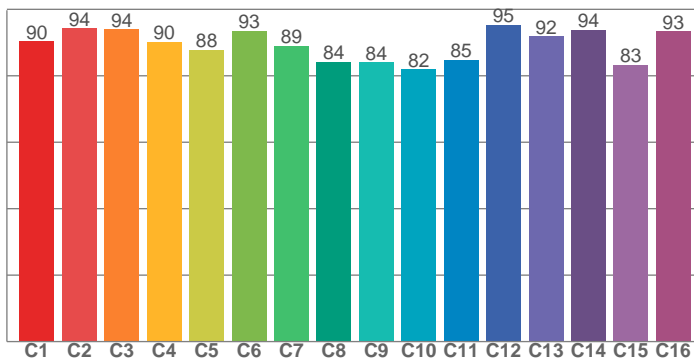

CRI: 95,1 (R1-R8)

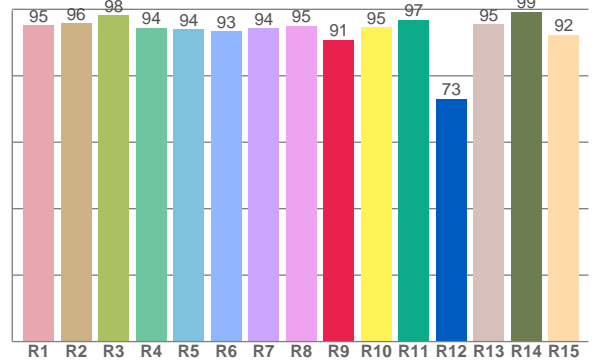

CRI R values, only R1-R8 are used to calculate final CRI value

R1	R2	R3	R4	R5	R6	R7	R8	R9	R10	R11	R12	R13	R14	R15
95,2	95,9	98,3	94,4	94,1	93,3	94,3	95,0	90,8	94,5	96,8	73,1	95,5	99,3	92,3

TM30 C values, 16 binned values out of total of 99 C values

C1	C2	C3	C4	C5	C6	C7	C8	C9	C10	C11	C12	C13	C14	C15	C16
90,3	94,2	93,9	90,2	87,8	93,5	89,1	84,2	84,1	81,9	84,8	95,3	91,9	93,9	83,3	93,4

CQS Q values

Q1	Q2	Q3	Q4	Q5	Q6	Q7	Q8	Q9	Q10	Q11	Q12	Q13	Q14	Q15
91,1	97,7	89,7	85,2	88,0	91,0	98,2	98,2	98,1	98,2	96,0	95,9	96,2	96,6	94,8

CQS: 93,0

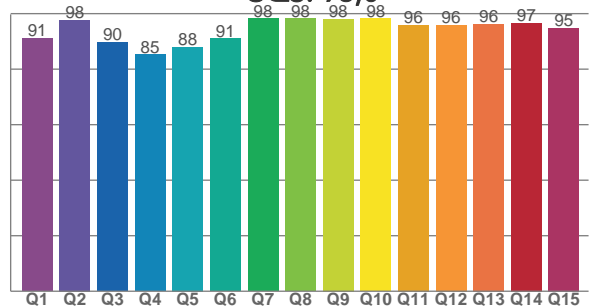

COLOR PARAMETERS

Color temperature	Color rendering index	Red component	Color fidelity	Color gamut	Color quality scale	Television lighting index	Color coordinate cie 1931	Color coordinate cie 1931	Color deviation from black body
CCT	CRI	CRI R9	TM30 Rf	TM30 Rg	CQS	TLCI	x	y	Δuv
5567 K	95,1	90,8	89,2	98,6	93,0	96	0,331	0,335	-0,0058

TM30 DETAILS

Rf 89,2
Fidelity index Rf

Rg 98,6
Gammut index

Hue Bin	R _f	Graphic shifts (%)	
		Chroma	Hue
1	90	-1%	2%
2	94	1%	1%
3	94	0%	-1%
4	90	-3%	-3%
5	88	-7%	-2%
6	93	-4%	0%
7	89	-5%	4%
8	84	-3%	8%
9	84	-1%	13%
10	82	2%	10%
11	85	5%	7%
12	95	3%	-1%
13	92	3%	-2%
14	94	-1%	-2%
15	83	8%	-8%
16	93	-2%	2%

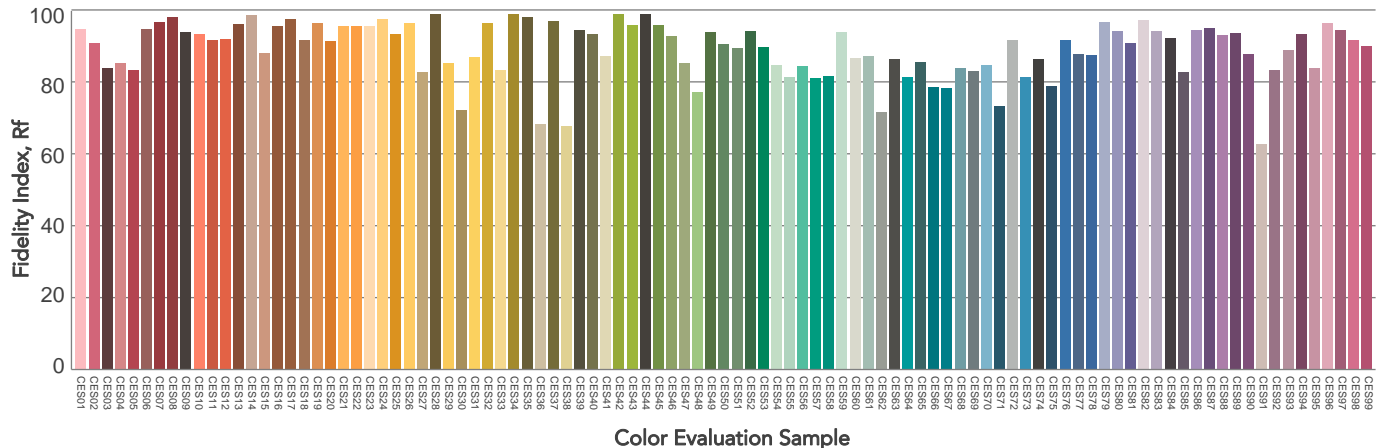
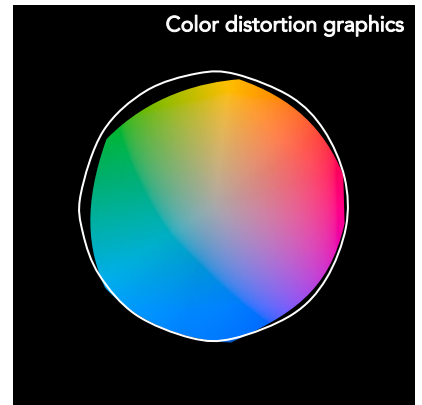
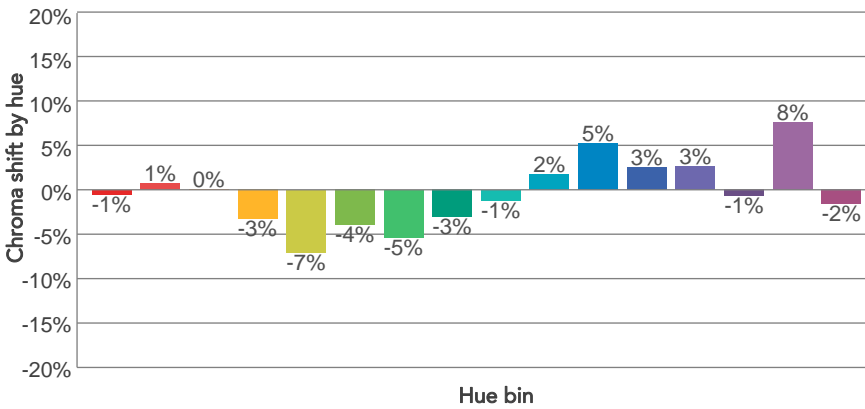
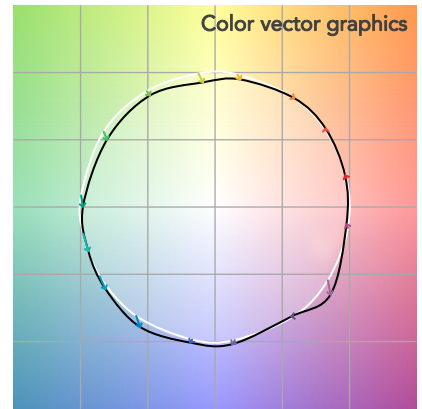
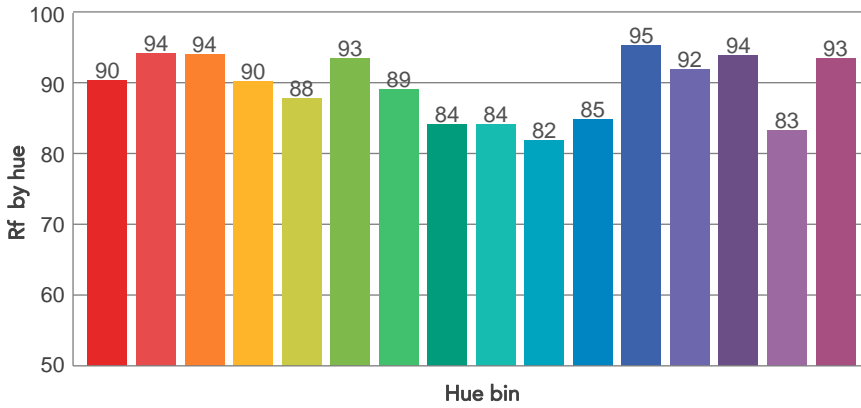
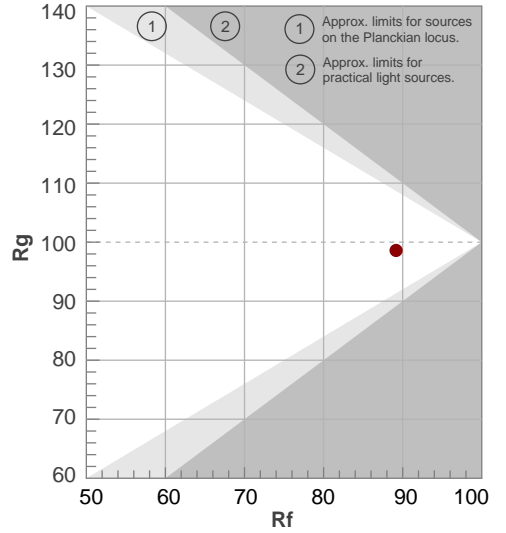

BEAM DETAILS



Beam angle 50%	Field angle 10%	Cutoff angle 2,5%	Intensity ratio in 120° cone	Intensity ratio in 90° cone
23°	39,9°	48,8°	97,1%	95,6%

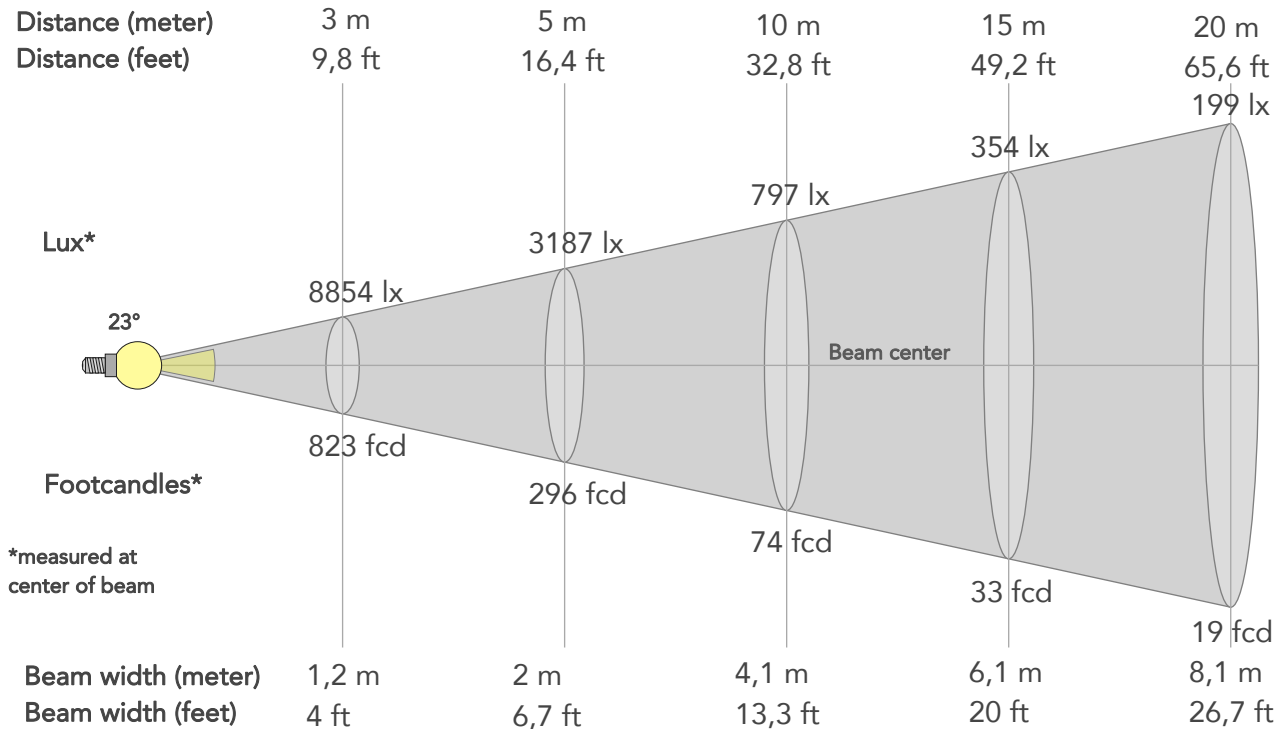

BEAM INTENSITIES AND WIDTHS

Distance	1m	2m	3m	4m	5m	7,5m	10m	15m	20m	25m	30m	40m	50m
Distance	3,3ft	6,6ft	9,8ft	13,1ft	16,4ft	24,6ft	32,8ft	49,2ft	65,6ft	82ft	98,4ft	131,2ft	164ft
Lux	79682lx	19921lx	8854lx	4980lx	3187lx	1417lx	797lx	354lx	199lx	127lx	89lx	50lx	32lx
Footcand.	7403fcd	1851fcd	823fcd	463fcd	296fcd	132fcd	74fcd	33fcd	19fcd	12fcd	8fcd	5fcd	3fcd
Beam wid.	0,4m	0,8m	1,2m	1,6m	2m	3,1m	4,1m	6,1m	8,1m	10,2m	12,2m	16,3m	20,3m
Beam wid.	1,3ft	2,7ft	4ft	5,3ft	6,7ft	10ft	13,3ft	20ft	26,7ft	33,4ft	40ft	53,4ft	66,7ft

LINEAR DISTRIBUTION DIAGRAM

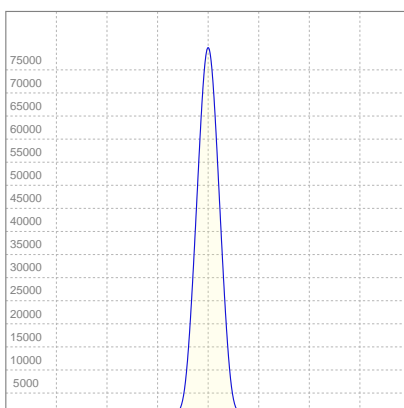

ELECTRICAL SPECIFICATIONS

Input voltage	Input current	Input power	Effeciency
223V	1,04A	218,1W	66lm/W

ISO CANDELA DIAGRAM

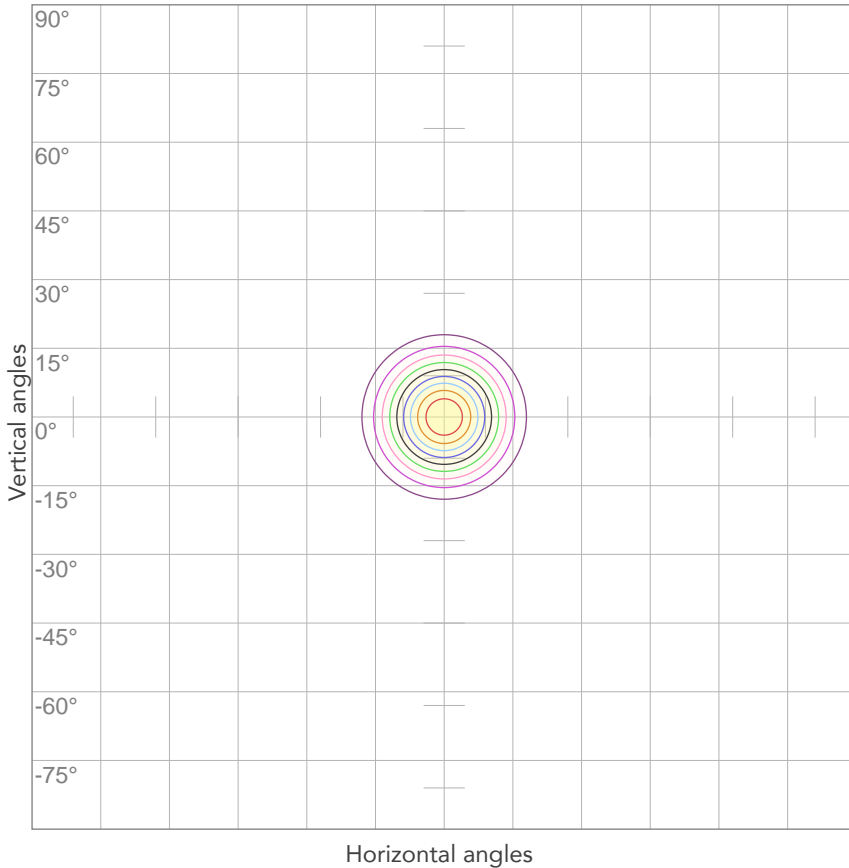

10%	7968 cd
20%	15936 cd
30%	23905 cd
40%	31873 cd
50%	39841 cd
60%	47809 cd
70%	55778 cd
80%	63746 cd

Conditions:

Number of c-planes: 2

Candela at center: 79682 cd

ISO LUX DIAGRAM

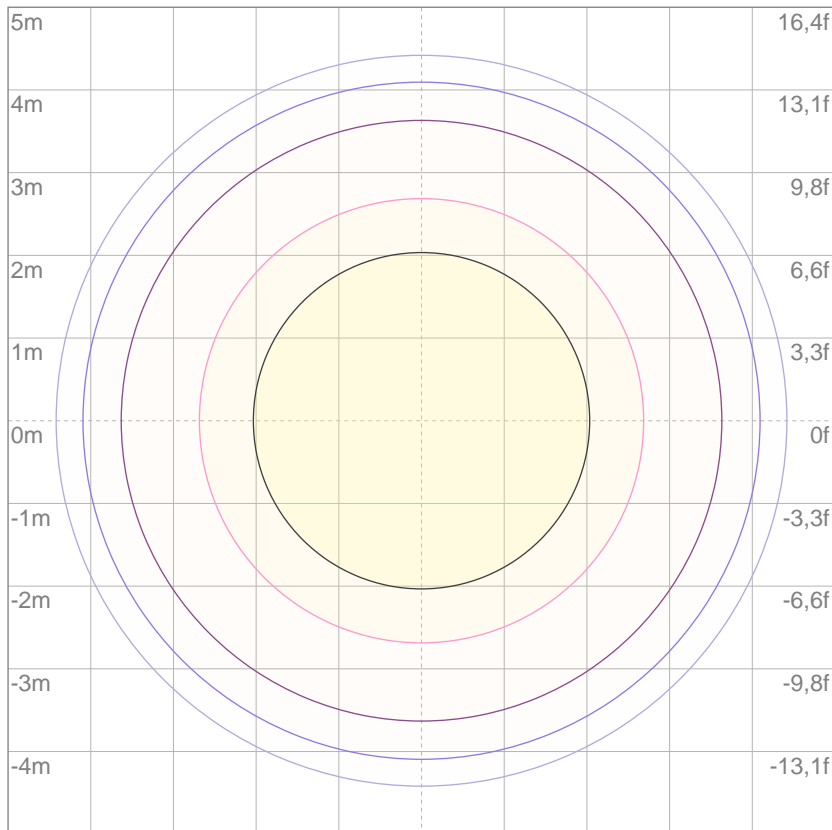

3%	23,9 lx
5%	39,8 lx
10%	79,7 lx
30%	239 lx
50%	398 lx

Conditions:

Number of c-planes: 2

Lux at center: 797 lx

Lux distribution on a surface when lamp is mounted at 10 meters from the surface.

Mounting height: 10 meters (33 feet)



Total lumen output:

12546 lm

Total candela output:

106512 cd

Light quality:

CRI: 95,2

Color temperature:

5544 K

PRODUCT NAME:

EclipseFresnel DY

MEASUREMENT CONDITIONS:

Beam angle:

15°

Target:

5600K

Operator:

Paolo Carvone

Date and time:

22/01/2020 15:27:25

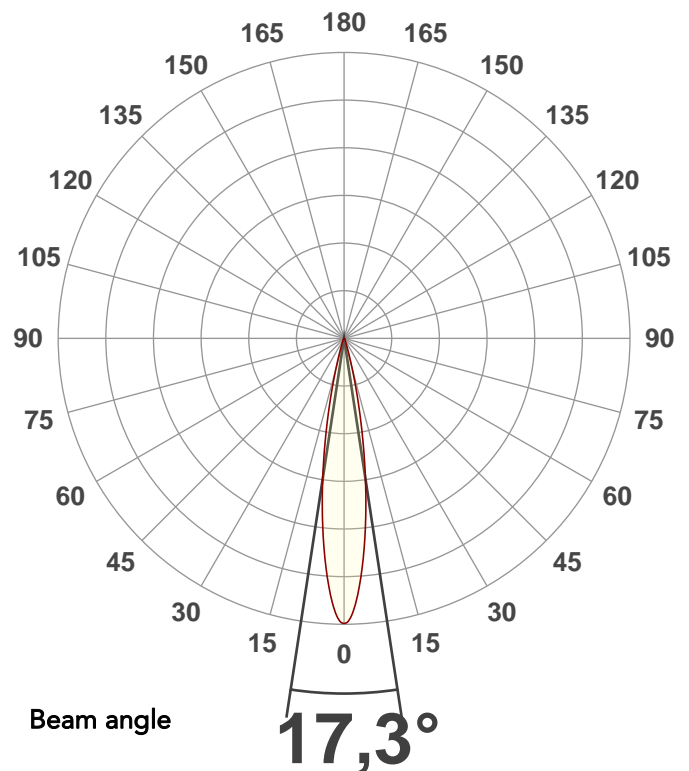

Spectra

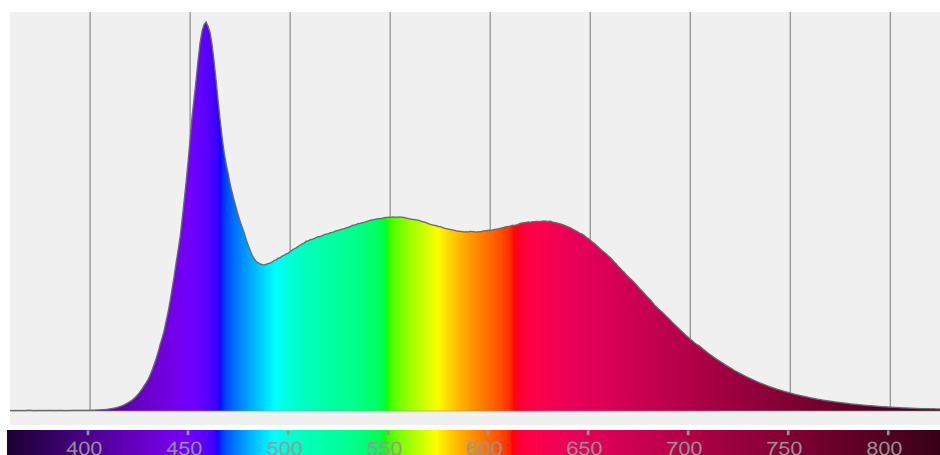

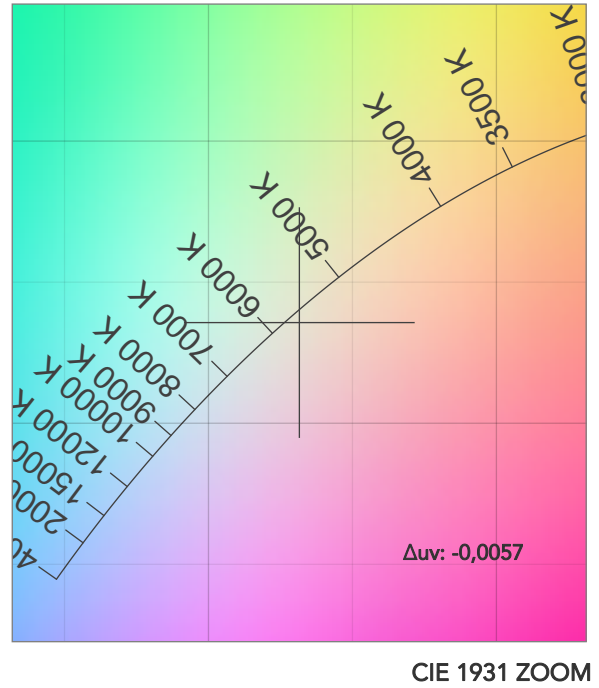
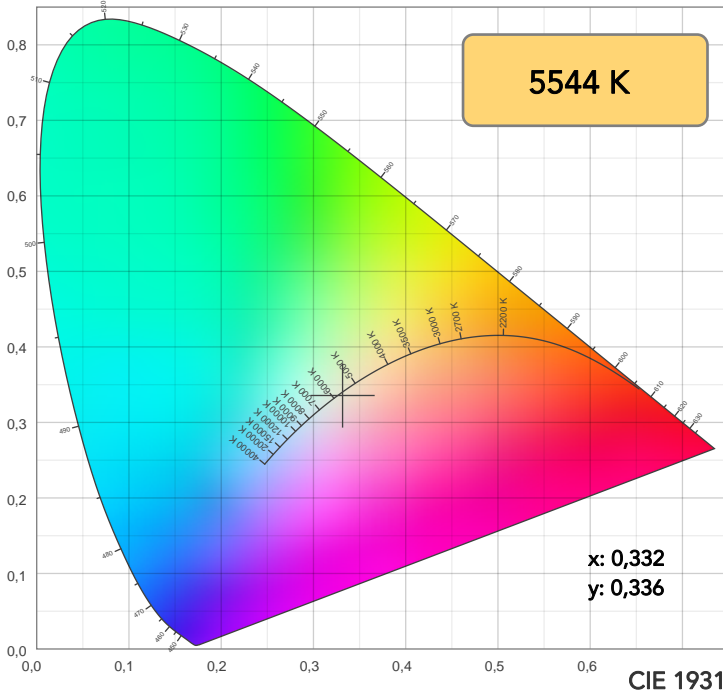

TM30: 89,2

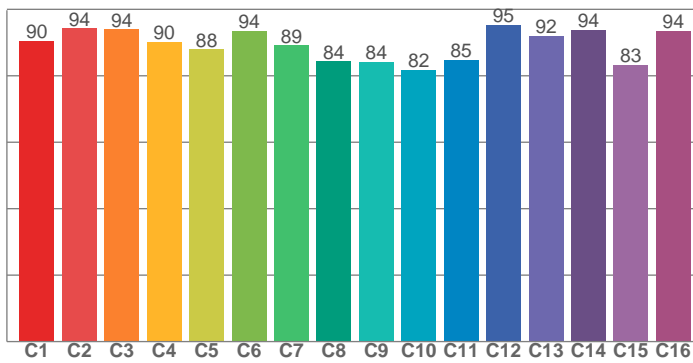

CRI: 95,2 (R1-R8)

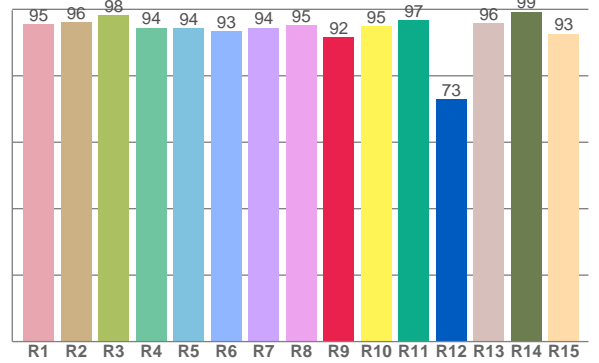

CRI R values, only R1-R8 are used to calculate final CRI value

R1	R2	R3	R4	R5	R6	R7	R8	R9	R10	R11	R12	R13	R14	R15
95,4	96,1	98,3	94,5	94,2	93,5	94,4	95,2	91,6	94,9	96,8	73,0	95,7	99,3	92,6

TM30 C values, 16 binned values out of total of 99 C values

C1	C2	C3	C4	C5	C6	C7	C8	C9	C10	C11	C12	C13	C14	C15	C16
90,4	94,3	94,0	90,3	87,9	93,6	89,2	84,3	84,1	81,9	84,7	95,4	92,0	93,8	83,3	93,5

CQS Q values

Q1	Q2	Q3	Q4	Q5	Q6	Q7	Q8	Q9	Q10	Q11	Q12	Q13	Q14	Q15
91,2	97,7	89,5	85,1	88,0	91,0	98,1	98,1	98,1	98,1	95,9	95,9	96,2	96,7	94,9

CQS: 93,0

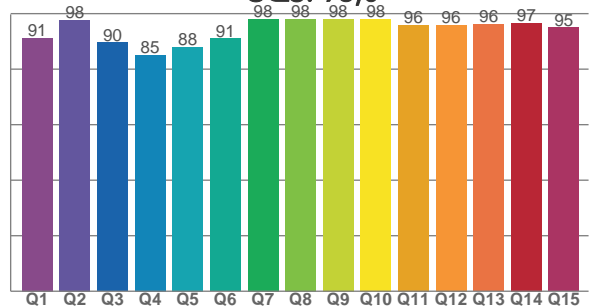

COLOR PARAMETERS

Color temperature	Color rendering index	Red component	Color fidelity	Color gamut	Color quality scale	Television lighting index	Color coordinate cie 1931	Color coordinate cie 1931	Color deviation from black body
CCT	CRI	CRI R9	TM30 Rf	TM30 Rg	CQS	TLCI	x	y	Δuv
5544 K	95,2	91,6	89,2	98,6	93,0	96	0,332	0,336	-0,0057

TM30 DETAILS

Rf 89,2
Fidelity index Rf

Rg 98,6
Gammut index

Hue Bin	R _f	Graphic shifts (%)	
		Chroma	Hue
1	90	-1%	2%
2	94	1%	1%
3	94	0%	-1%
4	90	-3%	-3%
5	88	-7%	-2%
6	94	-4%	0%
7	89	-5%	3%
8	84	-3%	8%
9	84	-1%	13%
10	82	2%	10%
11	85	5%	7%
12	95	3%	-1%
13	92	3%	-2%
14	94	-1%	-2%
15	83	8%	-8%
16	94	-2%	2%

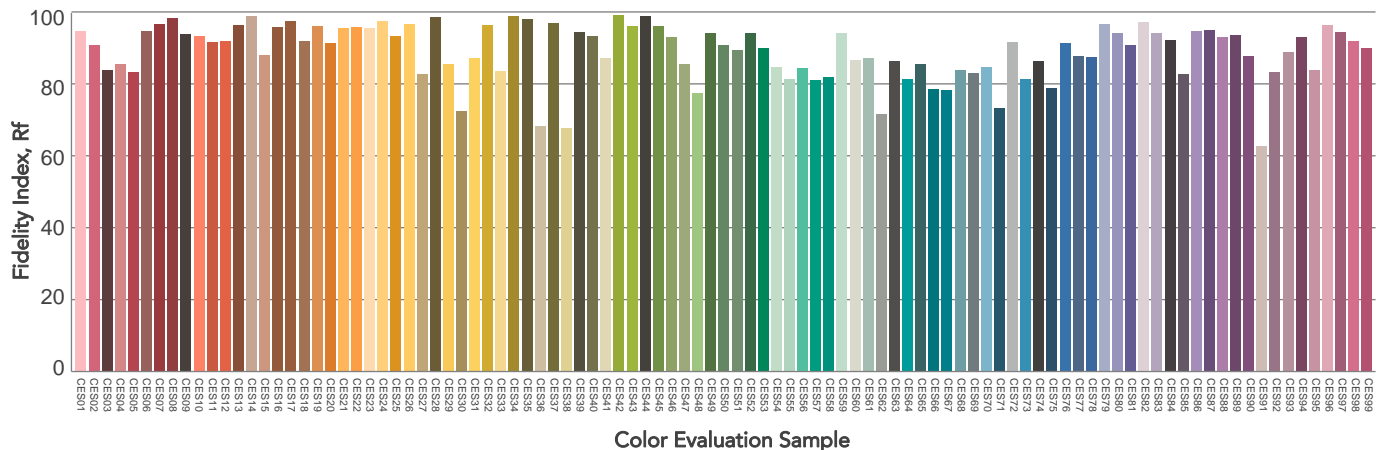
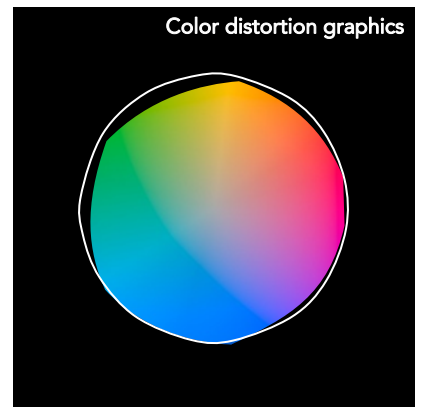
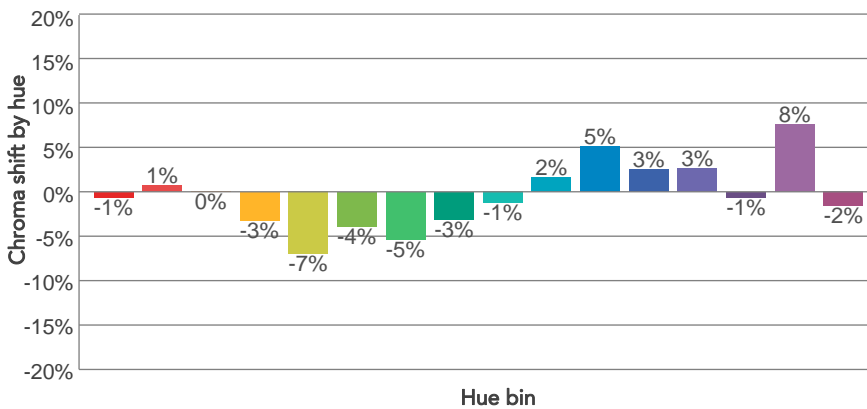
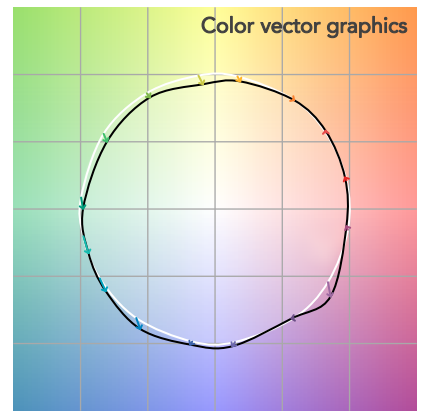
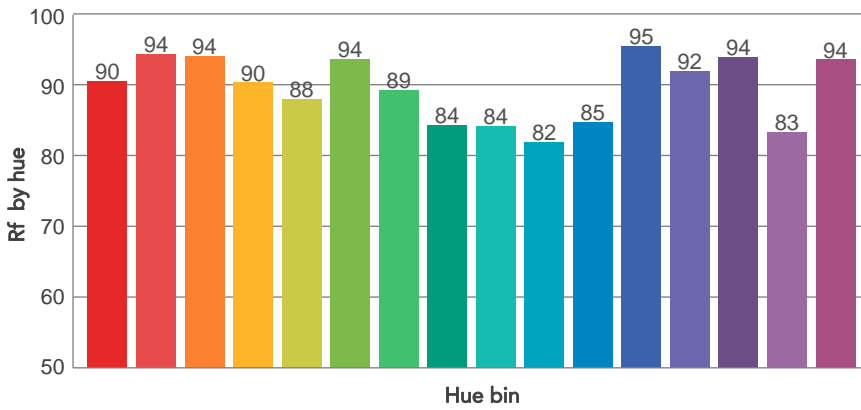
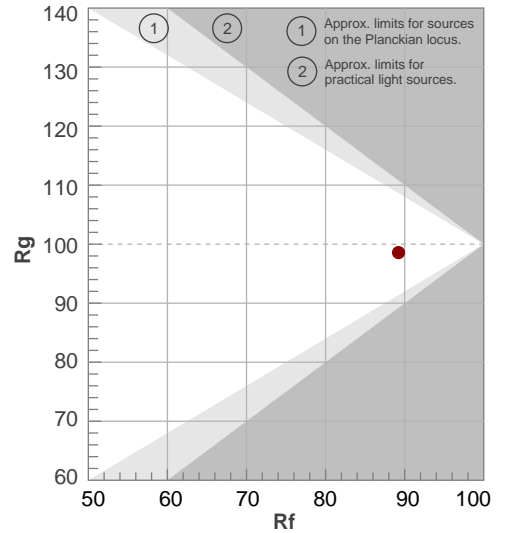

BEAM DETAILS



Beam angle 50%	Field angle 10%	Cutoff angle 2,5%	Intensity ratio in 120° cone	Intensity ratio in 90° cone
17,3°	30,7°	40,6°	94,1%	92,0%

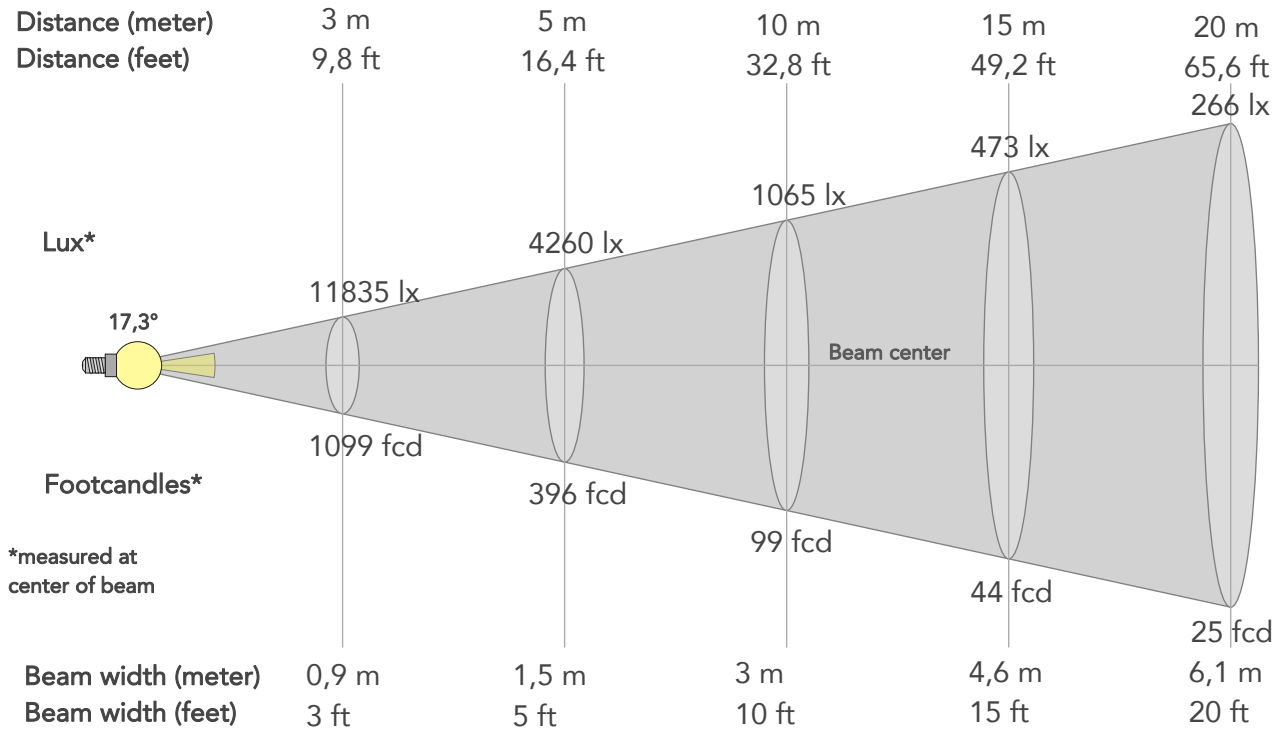

BEAM INTENSITIES AND WIDTHS

Distance	1m	2m	3m	4m	5m	7,5m	10m	15m	20m	25m	30m	40m	50m
Distance	3,3ft	6,6ft	9,8ft	13,1ft	16,4ft	24,6ft	32,8ft	49,2ft	65,6ft	82ft	98,4ft	131,2ft	164ft
Lux	106512lx	26628lx	11835lx	6657lx	4260lx	1894lx	1065lx	473lx	266lx	170lx	118lx	67lx	43lx
Footcand.	9895fcd	2474fcd	1099fcd	618fcd	396fcd	176fcd	99fcd	44fcd	25fcd	16fcd	11fcd	6fcd	4fcd
Beam wid.	0,3m	0,6m	0,9m	1,2m	1,5m	2,3m	3m	4,6m	6,1m	7,6m	9,1m	12,2m	15,2m
Beam wid.	1ft	2ft	3ft	4ft	5ft	7,5ft	10ft	15ft	20ft	24,9ft	29,9ft	39,9ft	49,9ft

LINEAR DISTRIBUTION DIAGRAM

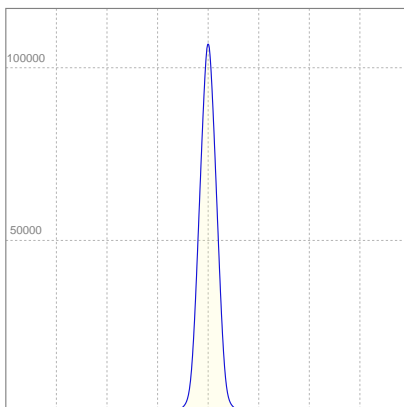

ELECTRICAL SPECIFICATIONS

Input voltage	Input current	Input power	Effeciency
222V	1,05A	219,7W	57lm/W

ISO CANDELA DIAGRAM

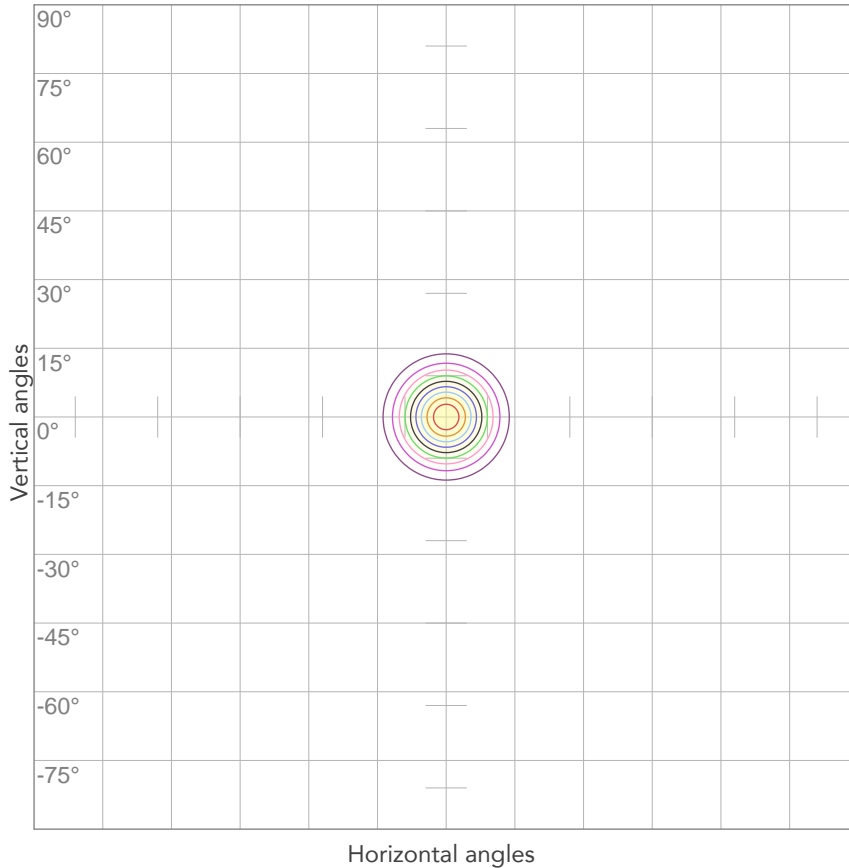

10%	10651 cd
20%	21302 cd
30%	31954 cd
40%	42605 cd
50%	53256 cd
60%	63907 cd
70%	74558 cd
80%	85210 cd

Conditions:

Number of c-planes: 2

Candela at center: 106512 cd

ISO LUX DIAGRAM

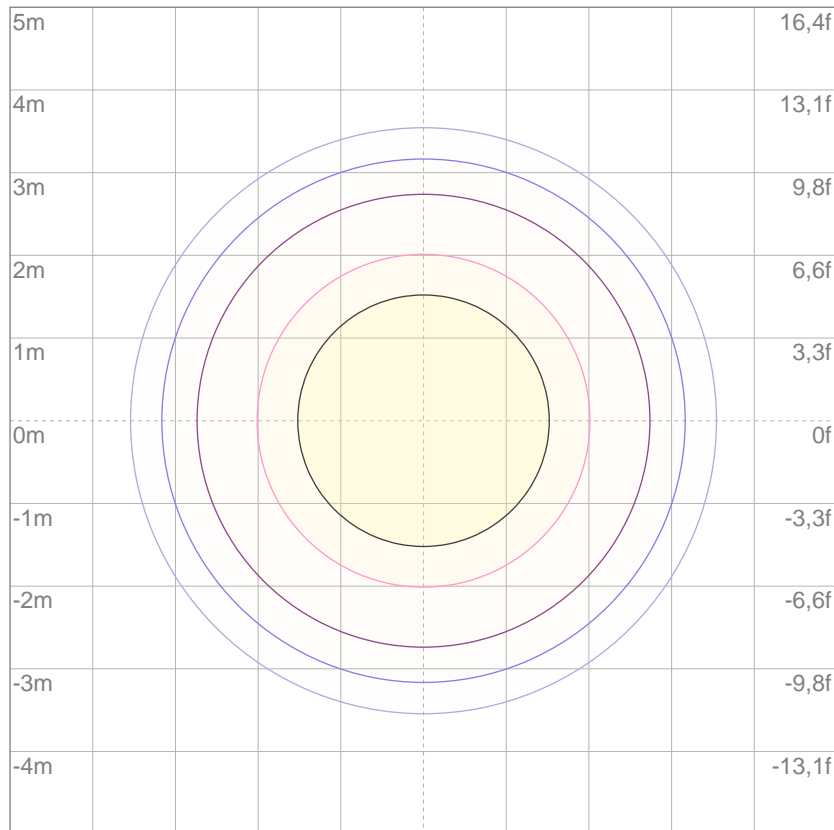

3%	32,0 lx
5%	53,3 lx
10%	107 lx
30%	320 lx
50%	533 lx

Conditions:

Number of c-planes: 2

Lux at center: 1065 lx

Lux distribution on a surface when lamp is mounted at 10 meters from the surface.

Mounting height: 10 meters (33 feet)