

# Photometric Test Report



## EclipseFresnel TW

Full colour and Tunable White with colour correction LED Fresnel to replace 1000 W

## CONTENTS

<b>Table of contents</b> .....	2
<b>Testing process</b> .....	4
<b>Color preset Full on</b>	
Beam angle 45° .....	5
Beam angle 30° .....	8
Beam angle 15° .....	11
<b>Color preset Red</b>	
Beam angle 45° .....	14
Beam angle 30° .....	17
Beam angle 15° .....	20
<b>Color preset Orange</b>	
Beam angle 45° .....	23
Beam angle 30° .....	26
Beam angle 15° .....	29
<b>Color preset Green</b>	
Beam angle 45° .....	32
Beam angle 30° .....	35
Beam angle 15° .....	38
<b>Color preset Royal Blue</b>	
Beam angle 45° .....	41
Beam angle 30° .....	44
Beam angle 15° .....	47
<b>Color preset Blue</b>	
Beam angle 45° .....	50
Beam angle 30° .....	53
Beam angle 15° .....	56
<b>Color preset Lime</b>	
Beam angle 45° .....	59
Beam angle 30° .....	62
Beam angle 15° .....	65

**Color temperature 2800K**

Beam angle 45° .....	68
Beam angle 30° .....	73
Beam angle 15° .....	78

**Color temperature 3200K**

Beam angle 45° .....	83
Beam angle 30° .....	88
Beam angle 15° .....	93

**Color temperature 4000K**

Beam angle 45° .....	98
Beam angle 30° .....	103
Beam angle 15° .....	108

**Color temperature 5600K**

Beam angle 45° .....	113
Beam angle 30° .....	118
Beam angle 15° .....	123

**Color temperature 6000K**

Beam angle 45° .....	128
Beam angle 30° .....	133
Beam angle 15° .....	138

## TESTING PROCESS

Prolights has its own optical testing laboratory in order to provide accurate photometric reports for its lighting products. The testing laboratory contains certain variety of precise lighting measurement systems that ensure an optimal reading of all the characteristic parameters of the lighting devices. All measurements are made at a controlled room temperature of 20°C without any external light sources. This photometric report is obtained through the data measured by a high precision measurement system and analyzed by a dedicate software.

### Prolights measurement instrument

Prolights measurement instrument is a complete measurement system for any light source. It's equipped with two-axis goniometer, that enables to measure the full 3D distribution field of the light source. This instrument measures the light intensity, the beam angle and the most significative colors parameters, like color temperature, spectral distribution, CRI, CQS, TM-30 with a very high accuracy rate.

**Please Note:** All measurements are made with light source at operating temperature. Before starting the measurement, the instrument analyzes the process of the light source during the heating phase. The measuring process of all the parameters begins only when the light emission is stable, that is with a variation of less than 0.5% in a 15 minutes time frame.

### Prolights measurement software

The software provides user friendly interface for the operator who does the measurements, and it also analyzes and processes all the collected data by the instrument. With this software it is possible to see the measured data in real-time and it is possible to examine all the measured data and graphics afterwards as well. All information is collected in a specific Prolights template, and the software creates also IES and LDT files, which are widely used to transfer the photometric data, and to develop lighting system.

Additionally, the fixtures are rechecked using various hand-held instruments like Sekonic C-700 and Gossen Mavospec Base, this is done to ensure, that the data in the photometric report are as accurate as possible.



Total lumen output:

7896 lm

Total candela output:

8595 cd

**PRODUCT NAME:**

EclipseFresnel TW

**MEASUREMENT CONDITIONS:**

Beam angle:

45°

Target:

Full on

Operator:

Marco Marrocco

Date and time:

14/12/2019 12:25:49

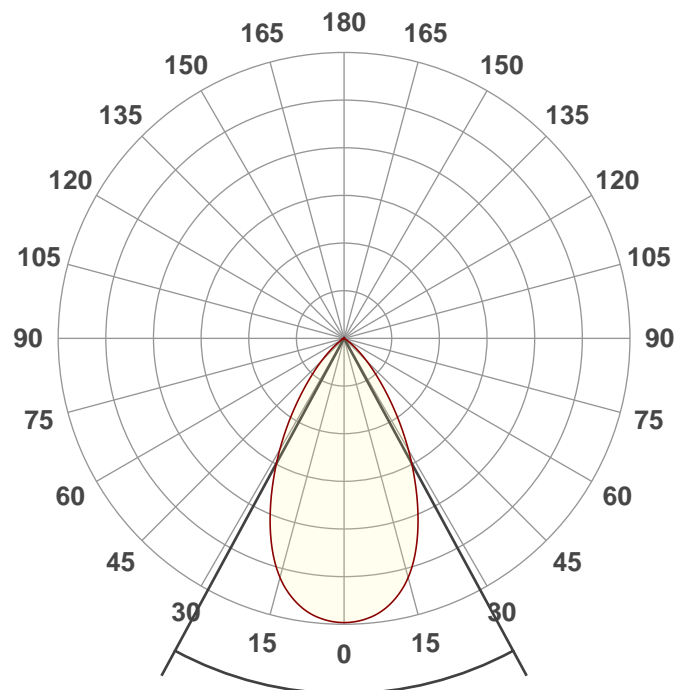

Beam angle

**56,8°**

Spectra

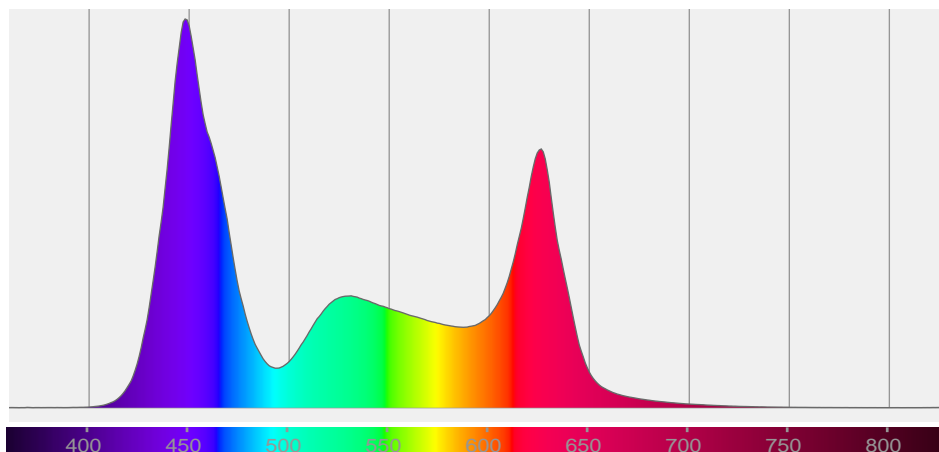

# BEAM DETAILS



Beam angle 50%	Field angle 10%	Cutoff angle 2,5%	Intensity ratio in 120° cone	Intensity ratio in 90° cone
56,8°	91,7°	108°	99,5%	93,7%

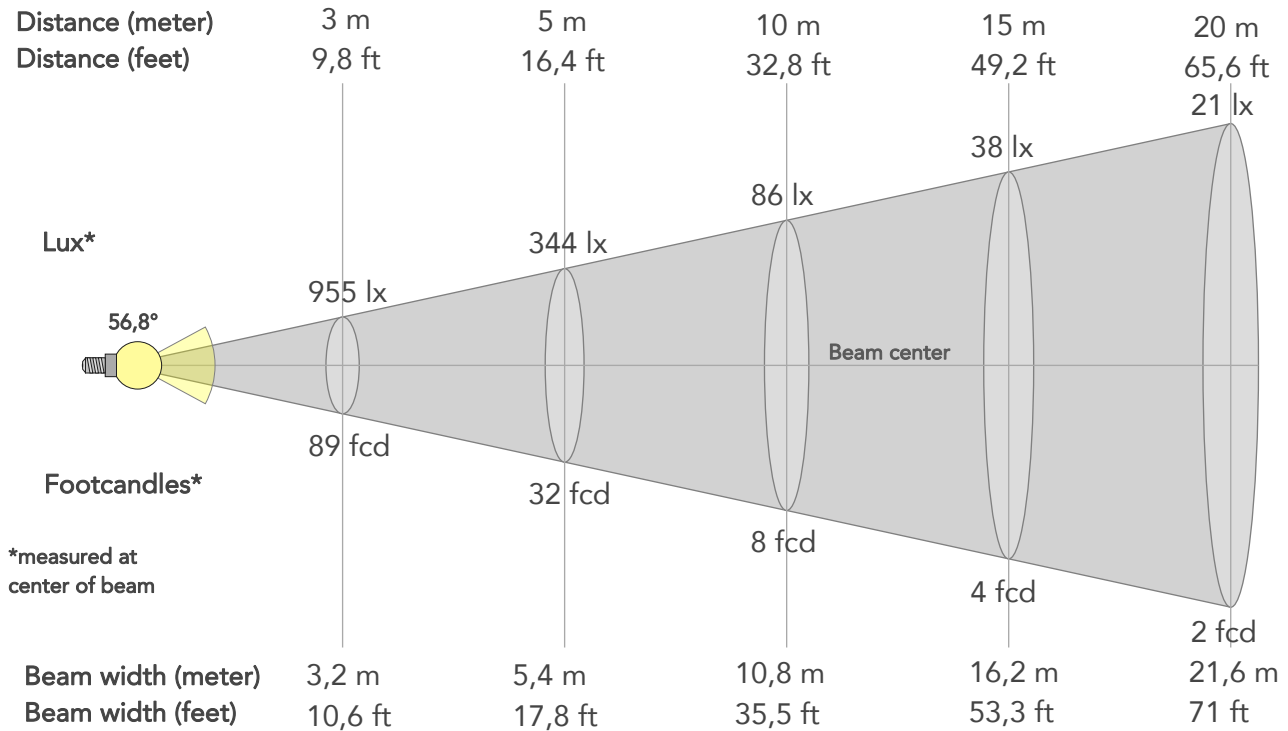

## BEAM INTENSITIES AND WIDTHS

Distance	1m	2m	3m	4m	5m	7,5m	10m	15m	20m	25m	30m	40m	50m
Distance	3,3ft	6,6ft	9,8ft	13,1ft	16,4ft	24,6ft	32,8ft	49,2ft	65,6ft	82ft	98,4ft	131,2ft	164ft
Lux	8595lx	2149lx	955lx	537lx	344lx	153lx	86lx	38lx	21lx	14lx	10lx	5lx	3lx
Footcand.	798fcd	200fcd	89fcd	50fcd	32fcd	14fcd	8fcd	4fcd	2fcd	1fcd	1fcd	0fcd	0fcd
Beam wid.	1,1m	2,2m	3,2m	4,3m	5,4m	8,1m	10,8m	16,2m	21,6m	27,1m	32,5m	43,3m	54,1m
Beam wid.	3,6ft	7,1ft	10,6ft	14,2ft	17,8ft	26,6ft	35,5ft	53,3ft	71ft	88,8ft	106,5ft	142ft	177,5ft

## LINEAR DISTRIBUTION DIAGRAM

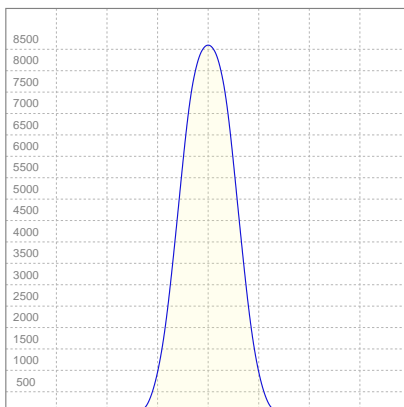

## ELECTRICAL SPECIFICATIONS

Input voltage	Input current	Input power	Effeciency
226V	1,15A	242,4W	33lm/W

## ISO CANDELA DIAGRAM

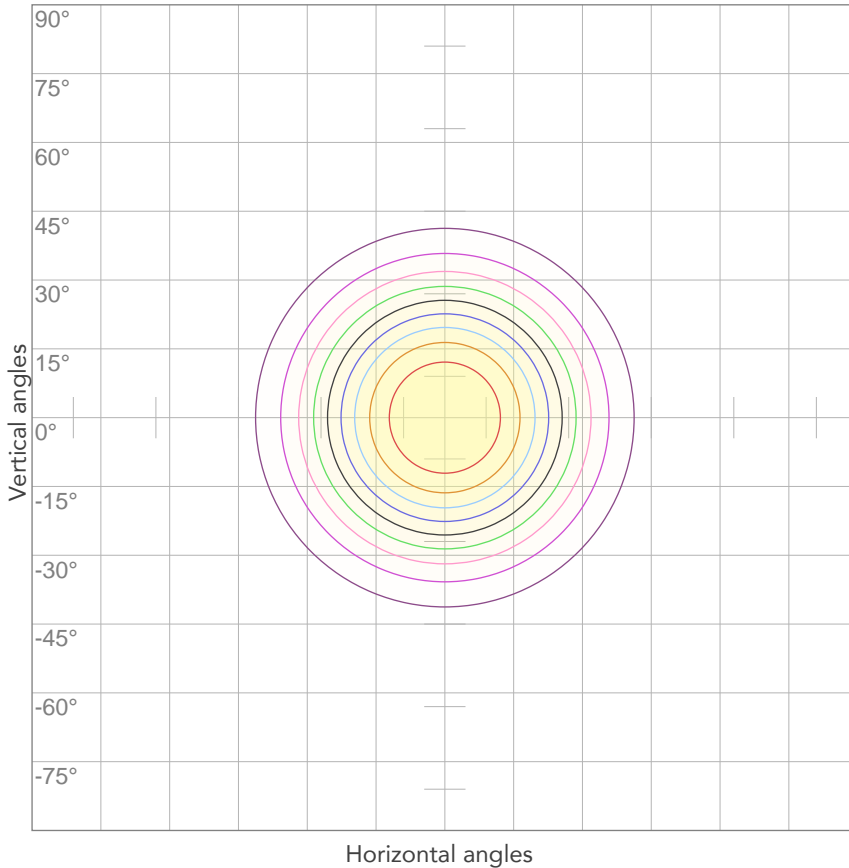

10%	859 cd
20%	1719 cd
30%	2578 cd
40%	3438 cd
50%	4297 cd
60%	5157 cd
70%	{LUX_1M70} cd
80%	6876 cd

**Conditions:**  
 Number of c-planes: 2  
 Candela at center: 8595 cd

## ISO LUX DIAGRAM

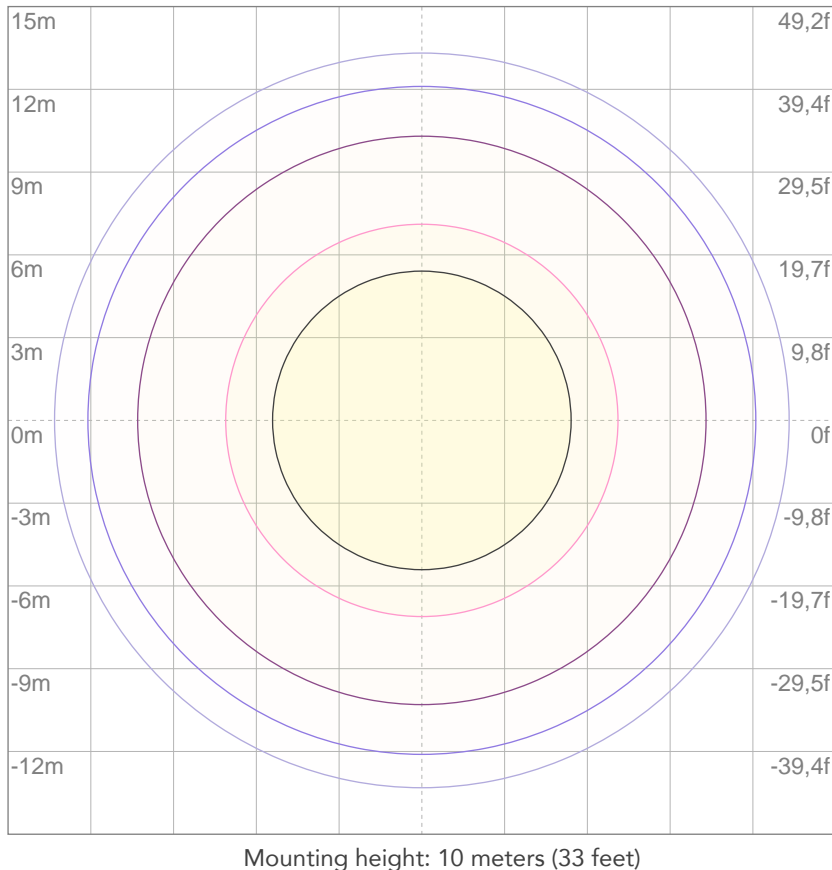

3%	2,58 lx
5%	4,30 lx
10%	8,59 lx
30%	25,8 lx
50%	43,0 lx

**Conditions:**  
 Number of c-planes: 2  
 Lux at center: 85,9 lx

*Lux distribution on a surface when lamp is mounted at 10 meters from the surface.*



Total lumen output:

7426 lm

Total candela output:

23642 cd

**PRODUCT NAME:**

EclipseFresnel TW

**MEASUREMENT CONDITIONS:**

Beam angle:

30°

Target:

Full on

Operator:

Marco Marrocco

Date and time:

14/12/2019 12:17:55

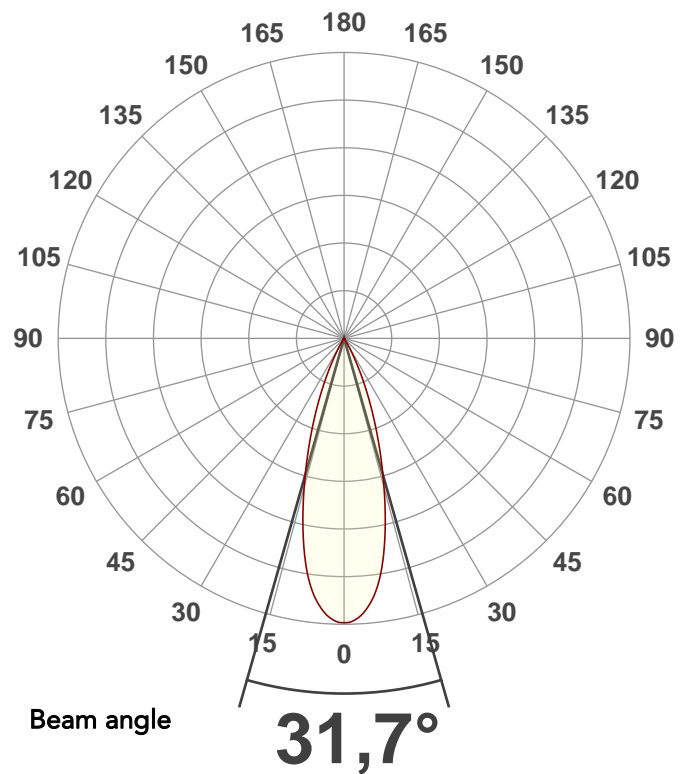

Spectra

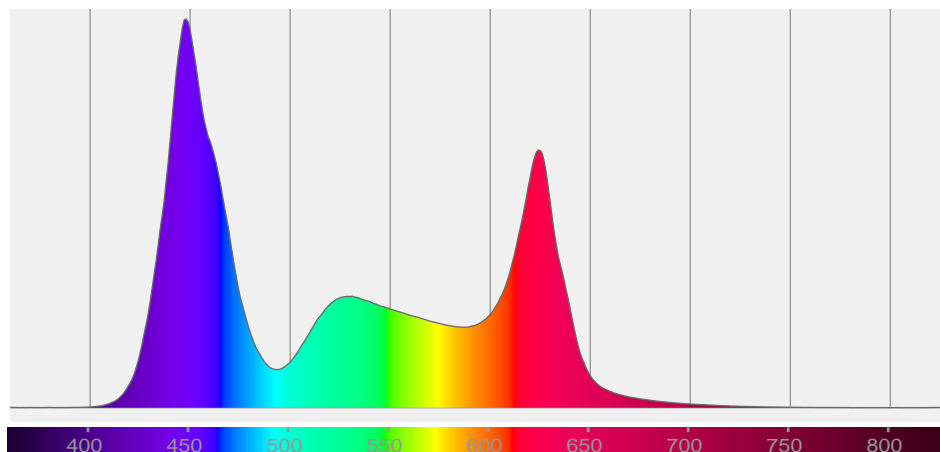



# BEAM DETAILS



Beam angle 50%	Field angle 10%	Cutoff angle 2,5%	Intensity ratio in 120° cone	Intensity ratio in 90° cone
31,7°	53,1°	62°	99,4%	98,3%

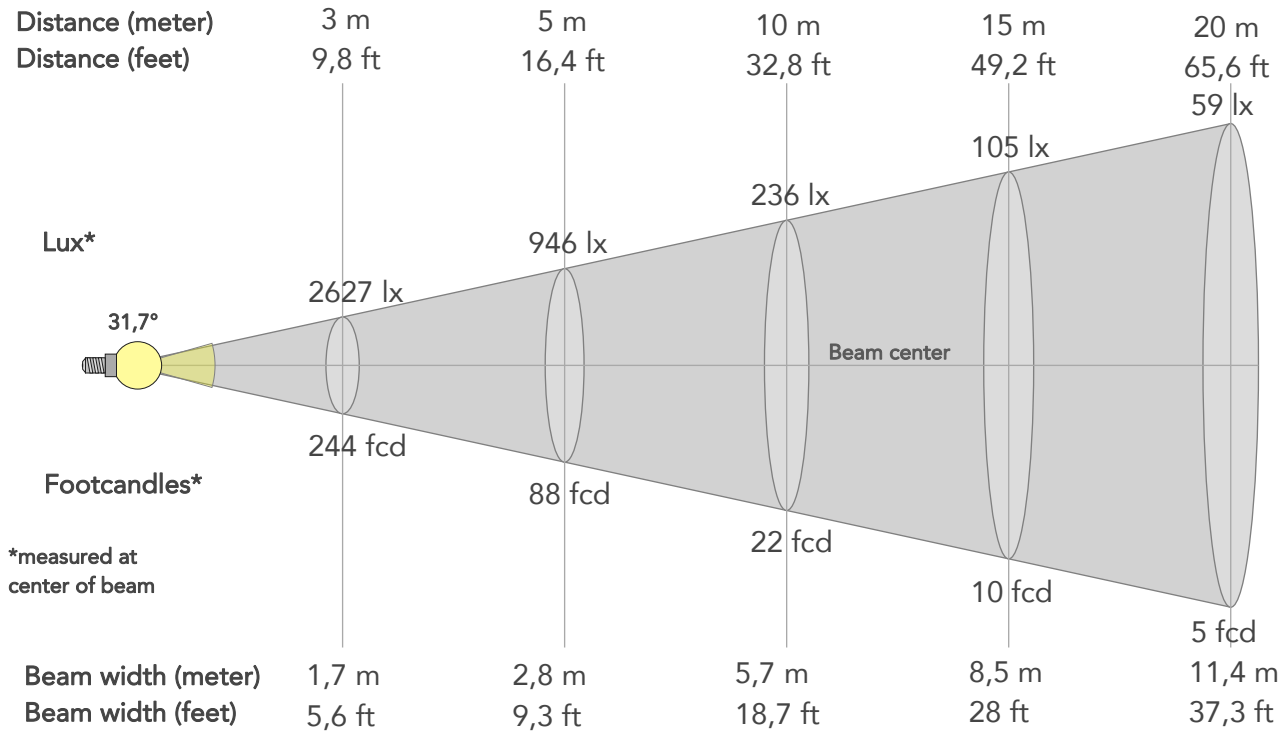

## BEAM INTENSITIES AND WIDTHS

Distance	1m	2m	3m	4m	5m	7,5m	10m	15m	20m	25m	30m	40m	50m
Distance	3,3ft	6,6ft	9,8ft	13,1ft	16,4ft	24,6ft	32,8ft	49,2ft	65,6ft	82ft	98,4ft	131,2ft	164ft
Lux	23642lx	5911lx	2627lx	1478lx	946lx	420lx	236lx	105lx	59lx	38lx	26lx	15lx	9lx
Footcand.	2196fcd	549fcd	244fcd	137fcd	88fcd	39fcd	22fcd	10fcd	5fcd	4fcd	2fcd	1fcd	1fcd
Beam wid.	0,6m	1,1m	1,7m	2,3m	2,8m	4,3m	5,7m	8,5m	11,4m	14,2m	17,1m	22,7m	28,4m
Beam wid.	1,9ft	3,8ft	5,6ft	7,5ft	9,3ft	14ft	18,7ft	28ft	37,3ft	46,6ft	56ft	74,6ft	93,3ft

## LINEAR DISTRIBUTION DIAGRAM

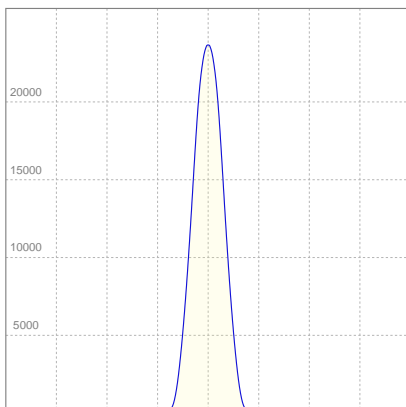

## ELECTRICAL SPECIFICATIONS

Input voltage	Input current	Input power	Effeciency
226V	1,18A	247,9W	30lm/W

## ISO CANDELA DIAGRAM

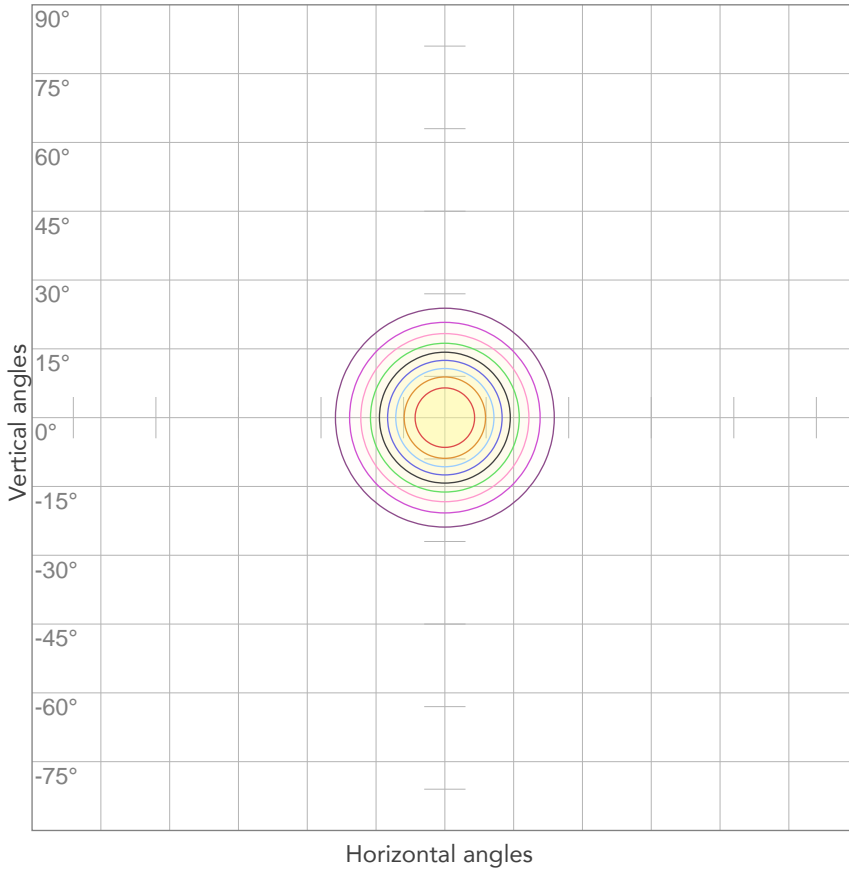

10%	2364 cd
20%	4728 cd
30%	7093 cd
40%	9457 cd
50%	11821 cd
60%	14185 cd
70%	{LUX_1M70} cd
80%	18914 cd

**Conditions:**  
 Number of c-planes: 2  
 Candela at center: 23642 cd

## ISO LUX DIAGRAM

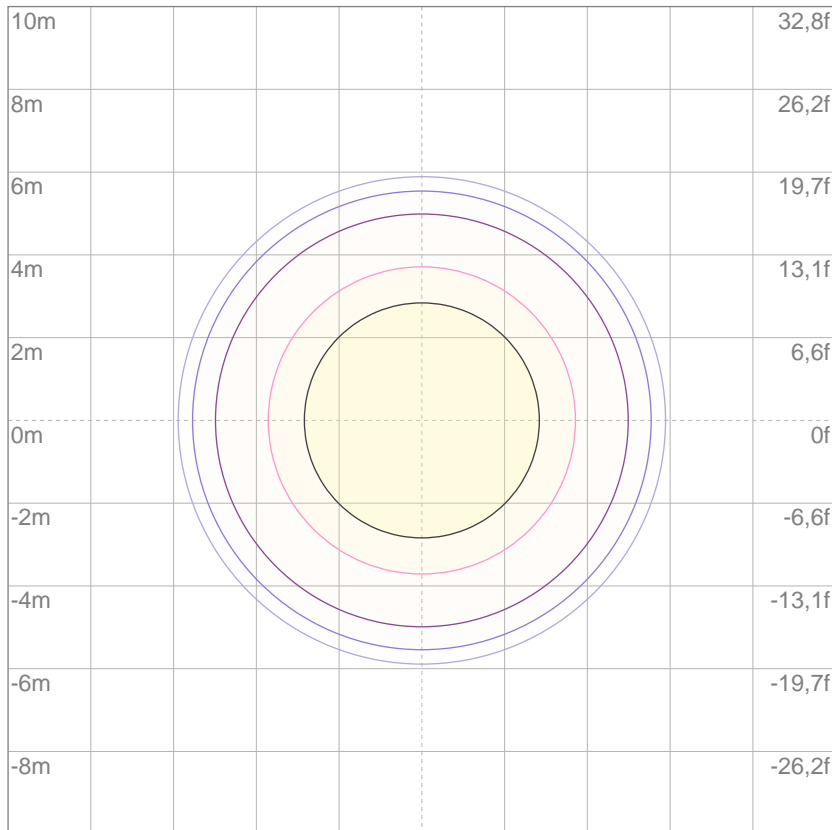

3%	7,09 lx
5%	11,8 lx
10%	23,6 lx
30%	70,9 lx
50%	118 lx

**Conditions:**  
 Number of c-planes: 2  
 Lux at center: 236 lx

*Lux distribution on a surface when lamp is mounted at 10 meters from the surface.*

Mounting height: 10 meters (33 feet)



Total lumen output:

4653 lm

Total candela output:

41959 cd

**PRODUCT NAME:**

EclipseFresnel TW

**MEASUREMENT CONDITIONS:**

Beam angle:

15°

Target:

Full on

Operator:

Marco Marrocco

Date and time:

14/12/2019 12:22:35

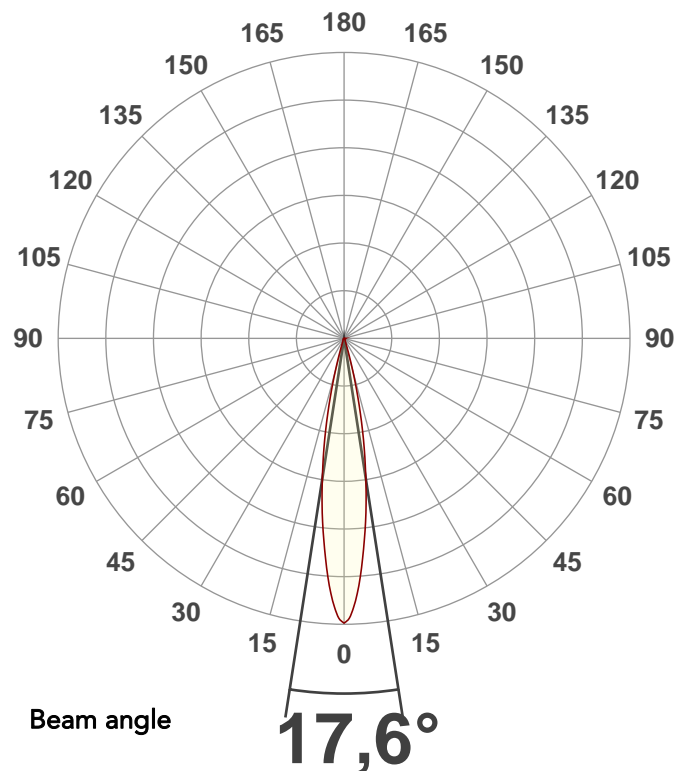

Spectra

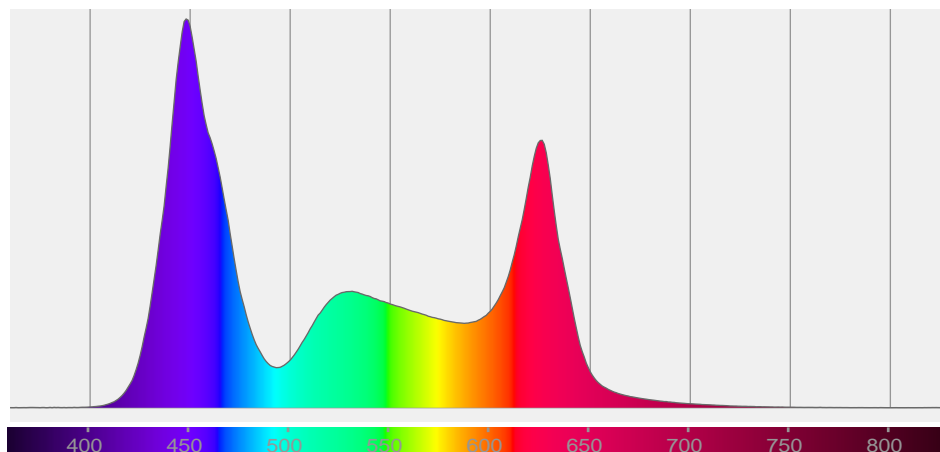

# BEAM DETAILS



Beam angle 50%	Field angle 10%	Cutoff angle 2,5%	Intensity ratio in 120° cone	Intensity ratio in 90° cone
17,6°	31°	38,1°	99,4%	98,0%

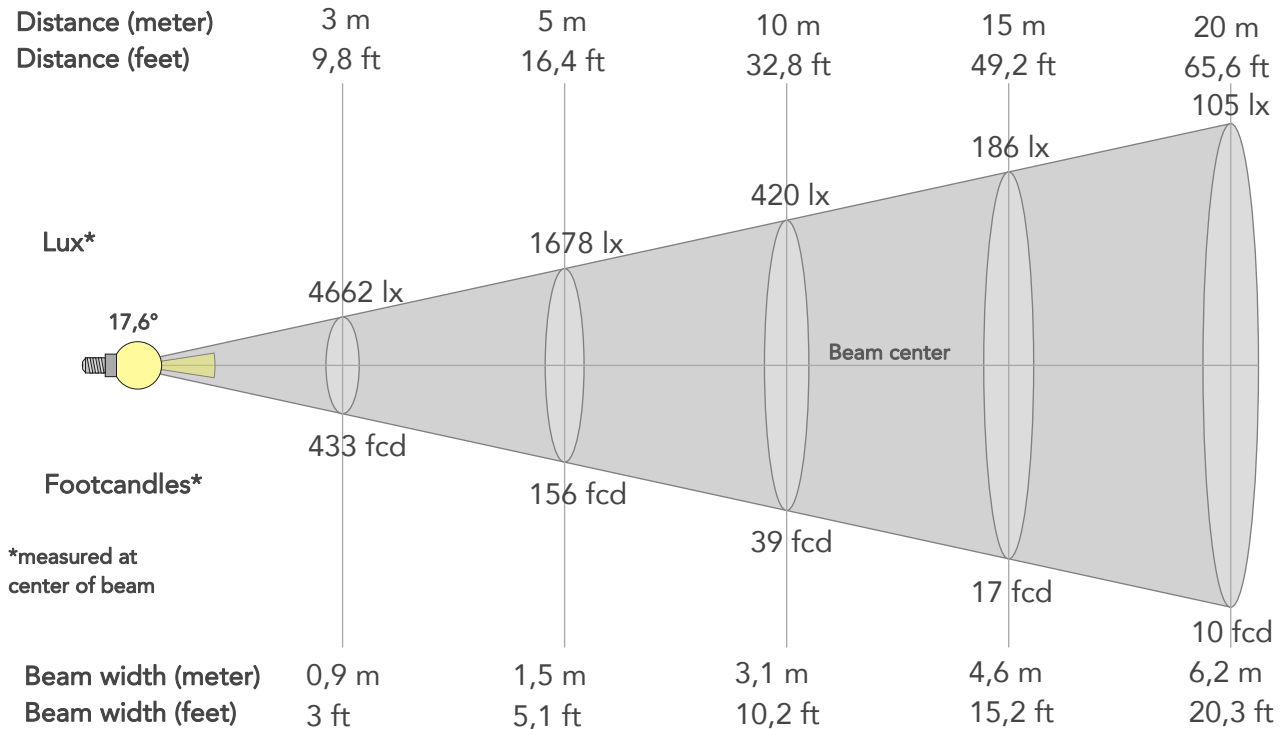

## BEAM INTENSITIES AND WIDTHS

Distance	1m	2m	3m	4m	5m	7,5m	10m	15m	20m	25m	30m	40m	50m
Distance	3,3ft	6,6ft	9,8ft	13,1ft	16,4ft	24,6ft	32,8ft	49,2ft	65,6ft	82ft	98,4ft	131,2ft	164ft
Lux	41959lx	10490lx	4662lx	2622lx	1678lx	746lx	420lx	186lx	105lx	67lx	47lx	26lx	17lx
Footcand.	3898fcd	975fcd	433fcd	244fcd	156fcd	69fcd	39fcd	17fcd	10fcd	6fcd	4fcd	2fcd	2fcd
Beam wid.	0,3m	0,6m	0,9m	1,2m	1,5m	2,3m	3,1m	4,6m	6,2m	7,7m	9,3m	12,4m	15,5m
Beam wid.	1ft	2ft	3ft	4,1ft	5,1ft	7,6ft	10,2ft	15,2ft	20,3ft	25,4ft	30,5ft	40,6ft	50,8ft

## LINEAR DISTRIBUTION DIAGRAM

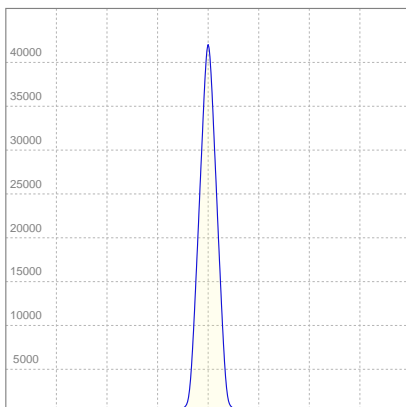

## ELECTRICAL SPECIFICATIONS

Input voltage	Input current	Input power	Efficiency
226V	1,16A	244,2W	19lm/W

## ISO CANDELA DIAGRAM

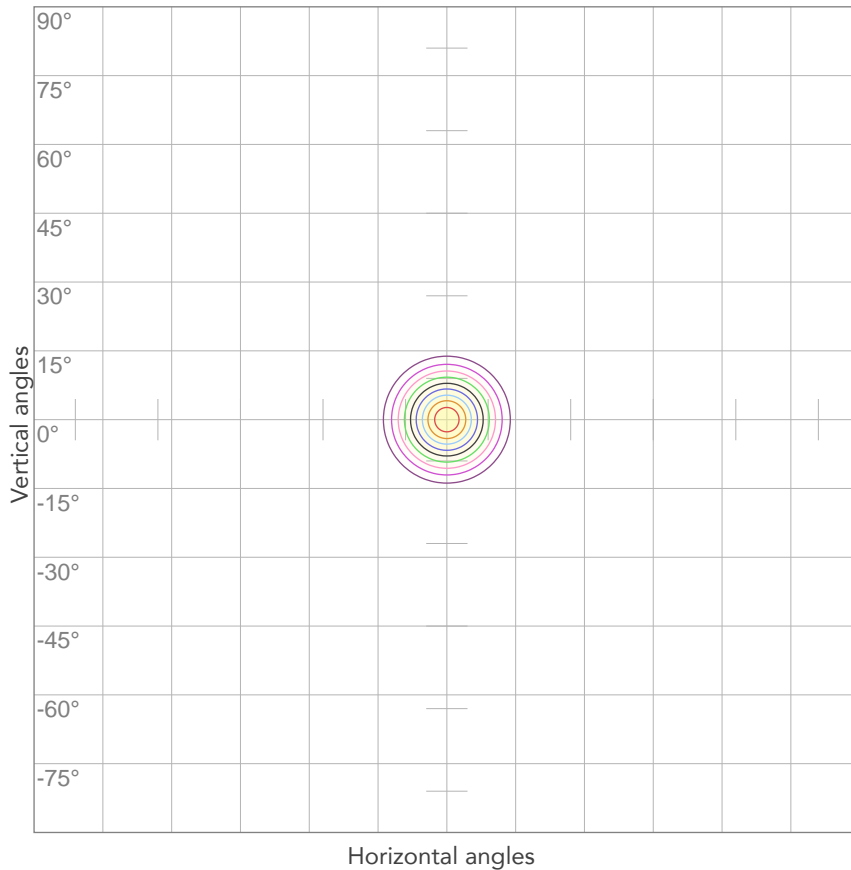

10%	4196 cd
20%	8392 cd
30%	12588 cd
40%	16783 cd
50%	20979 cd
60%	25175 cd
70%	{LUX_1M70} cd
80%	33567 cd

Conditions:  
 Number of c-planes: 2  
 Candela at center: 41959 cd

## ISO LUX DIAGRAM

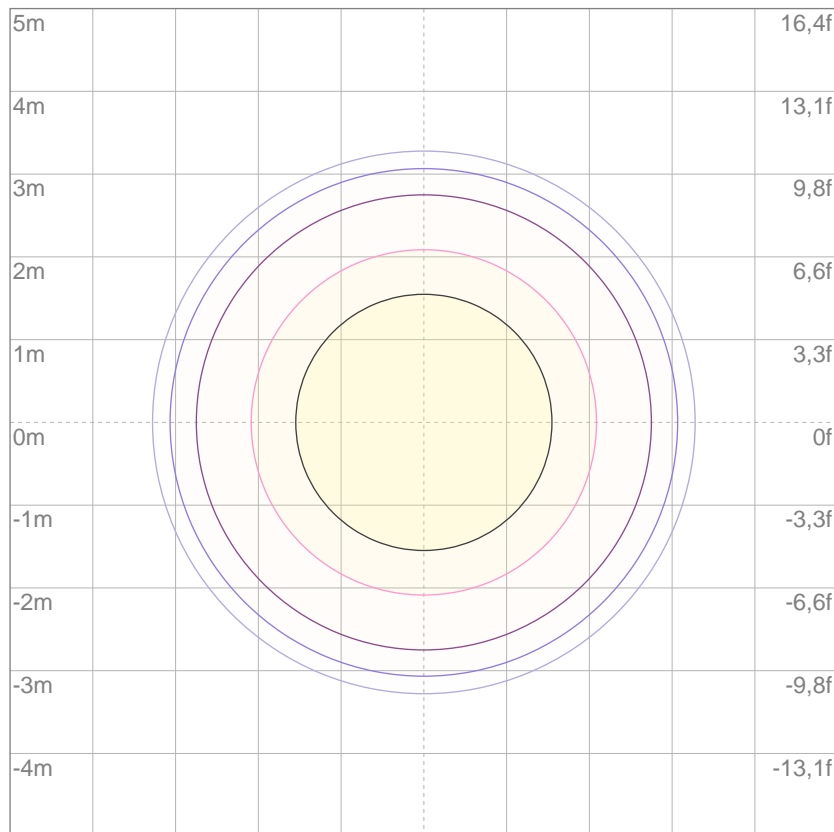

3%	12,6 lx
5%	21,0 lx
10%	42,0 lx
30%	126 lx
50%	210 lx

Conditions:  
 Number of c-planes: 2  
 Lux at center: 420 lx

*Lux distribution on a surface when lamp is mounted at 10 meters from the surface.*

Mounting height: 10 meters (33 feet)



Total lumen output:

422 lm

Total candela output:

418 cd

**PRODUCT NAME:**

EclipseFresnel TW

**MEASUREMENT CONDITIONS:**

Beam angle:

45°

Target:

Red

Operator:

Marco Marrocco

Date and time:

14/12/2019 10:24:56

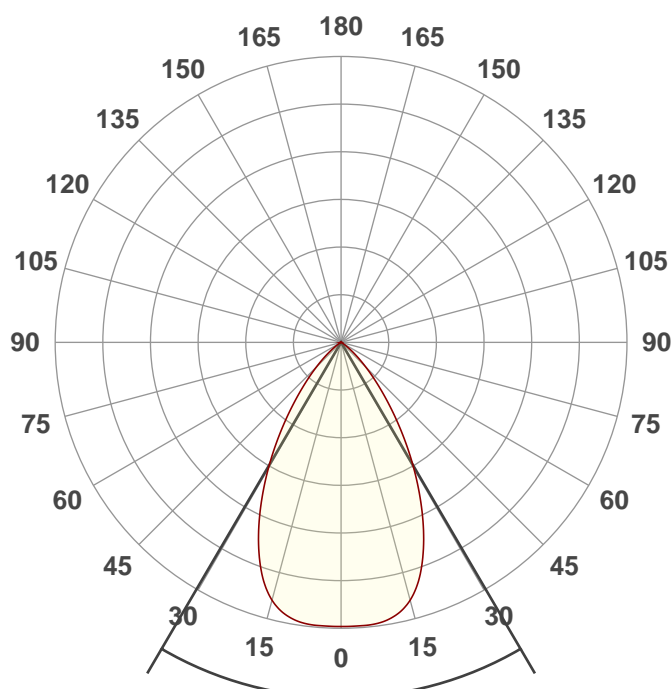

Beam angle

**60,7°**

Spectra

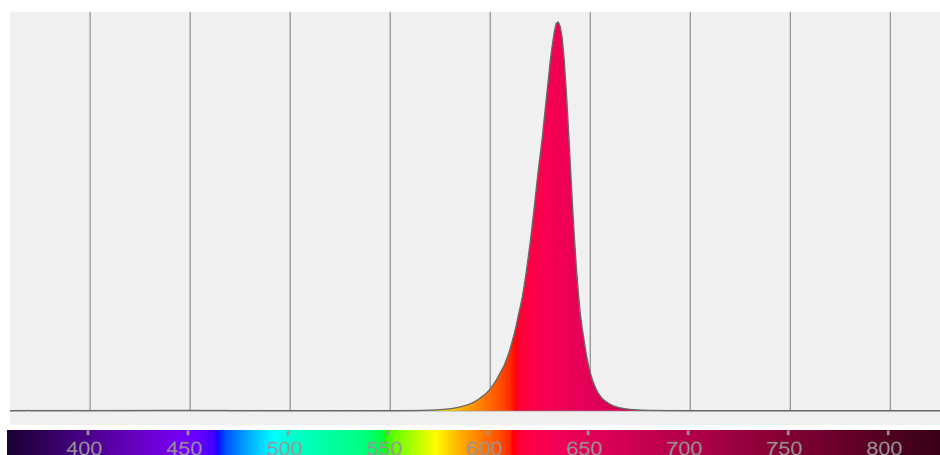

# BEAM DETAILS



Beam angle 50%	Field angle 10%	Cutoff angle 2,5%	Intensity ratio in 120° cone	Intensity ratio in 90° cone
60,7°	93,2°	108,6°	99,5%	93,7%

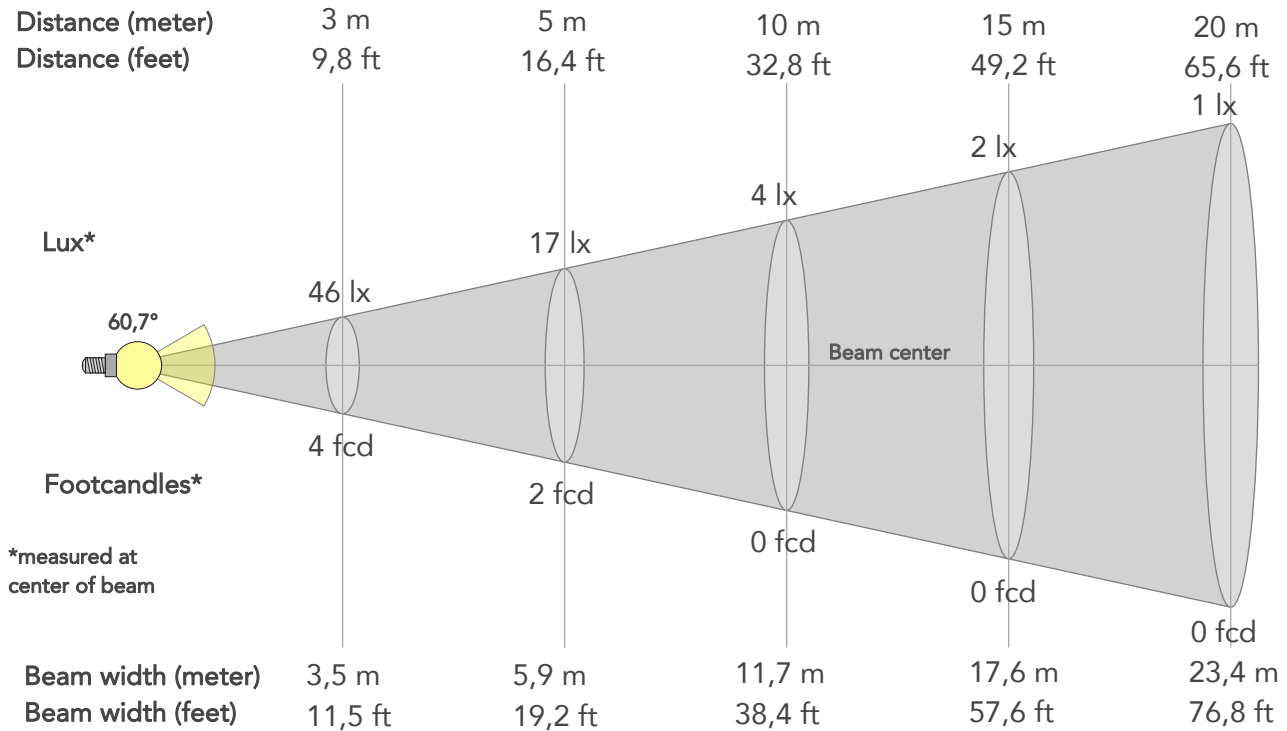

## BEAM INTENSITIES AND WIDTHS

Distance	1m	2m	3m	4m	5m	7,5m	10m	15m	20m	25m	30m	40m	50m
Distance	3,3ft	6,6ft	9,8ft	13,1ft	16,4ft	24,6ft	32,8ft	49,2ft	65,6ft	82ft	98,4ft	131,2ft	164ft
Lux	418lx	104lx	46lx	26lx	17lx	7lx	4lx	2lx	1lx	1lx	0lx	0lx	0lx
Footcand.	39fcd	10fcd	4fcd	2fcd	2fcd	1fcd	0fcd	0fcd	0fcd	0fcd	0fcd	0fcd	0fcd
Beam wid.	1,2m	2,3m	3,5m	4,7m	5,9m	8,8m	11,7m	17,6m	23,4m	29,3m	35,1m	46,8m	58,6m
Beam wid.	3,9ft	7,7ft	11,5ft	15,3ft	19,2ft	28,8ft	38,4ft	57,6ft	76,8ft	96ft	115,2ft	153,7ft	192,1ft

## LINEAR DISTRIBUTION DIAGRAM

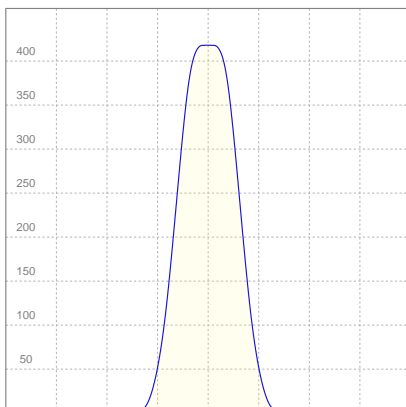

## ELECTRICAL SPECIFICATIONS

Input voltage	Input current	Input power	Effeciency
228V	0,220A	24,6W	17lm/W

## ISO CANDELA DIAGRAM

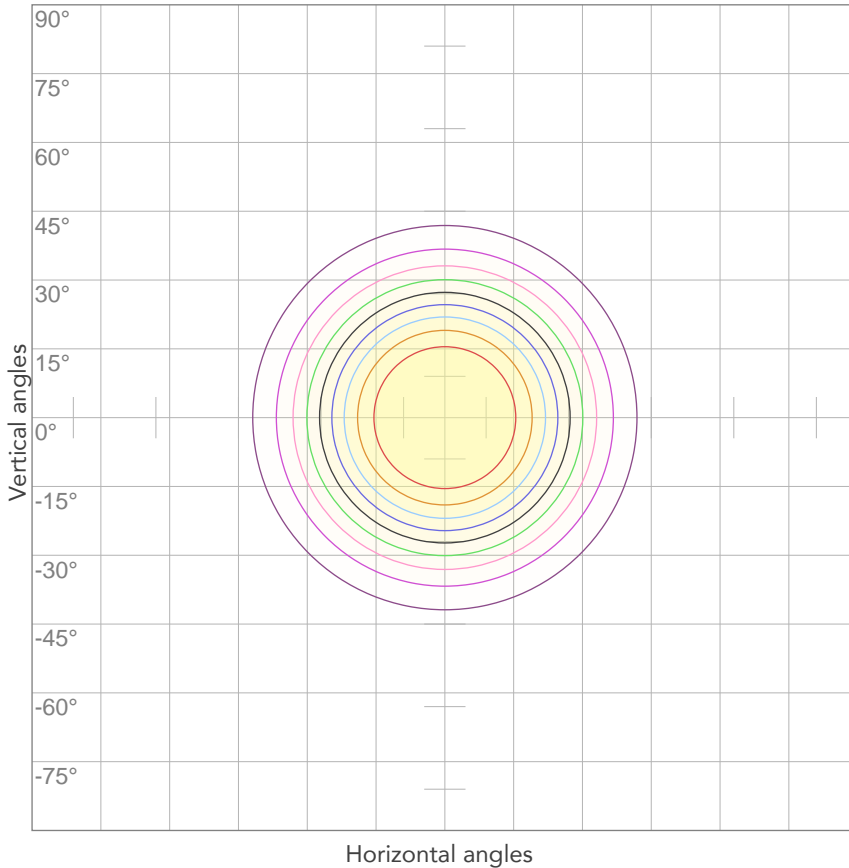

10%	42 cd
20%	84 cd
30%	125 cd
40%	167 cd
50%	209 cd
60%	251 cd
70%	{LUX_1M70} cd
80%	334 cd

Conditions:

Number of c-planes: 2

Candela at center: 418 cd

## ISO LUX DIAGRAM

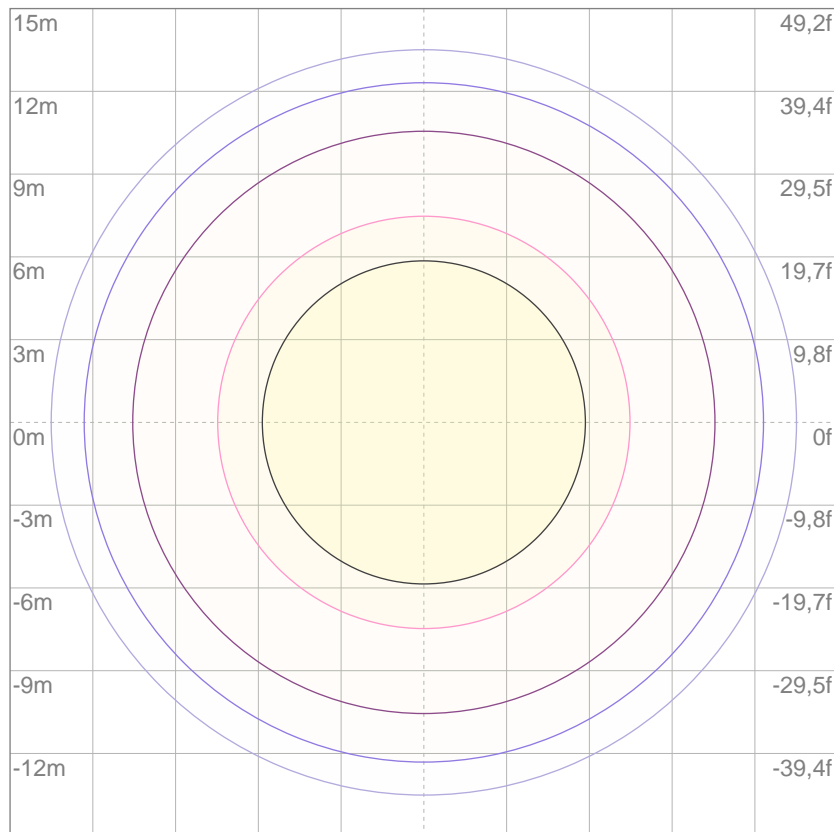

3%	0,125 lx
5%	0,209 lx
10%	0,418 lx
30%	1,25 lx
50%	2,09 lx

Conditions:

Number of c-planes: 2

Lux at center: 4,18 lx

*Lux distribution on a surface when lamp is mounted at 10 meters from the surface.*

Mounting height: 10 meters (33 feet)





Total lumen output:

383 lm

Total candela output:

1158 cd

**PRODUCT NAME:**

EclipseFresnel TW

**MEASUREMENT CONDITIONS:**

Beam angle:

30°

Target:

Red

Operator:

Marco Marrocco

Date and time:

14/12/2019 12:03:48

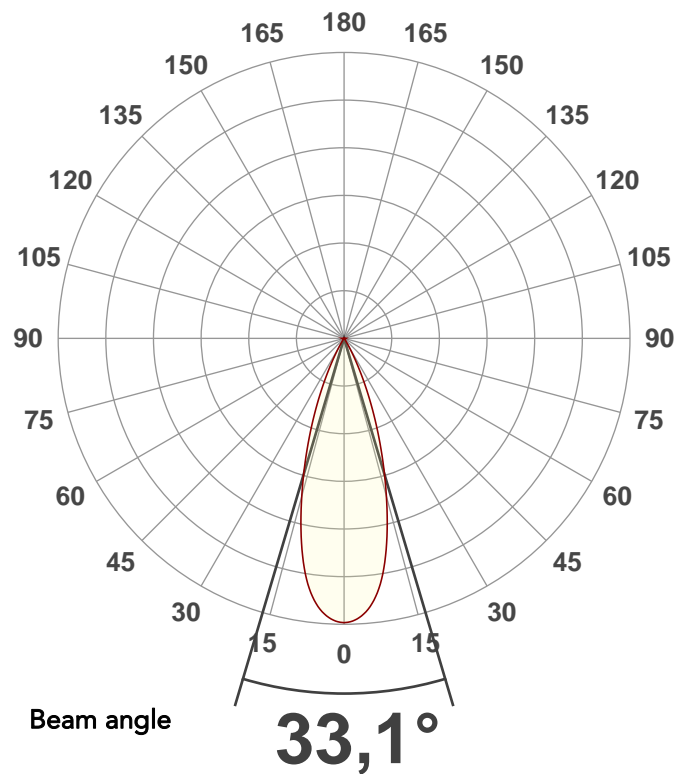

Spectra

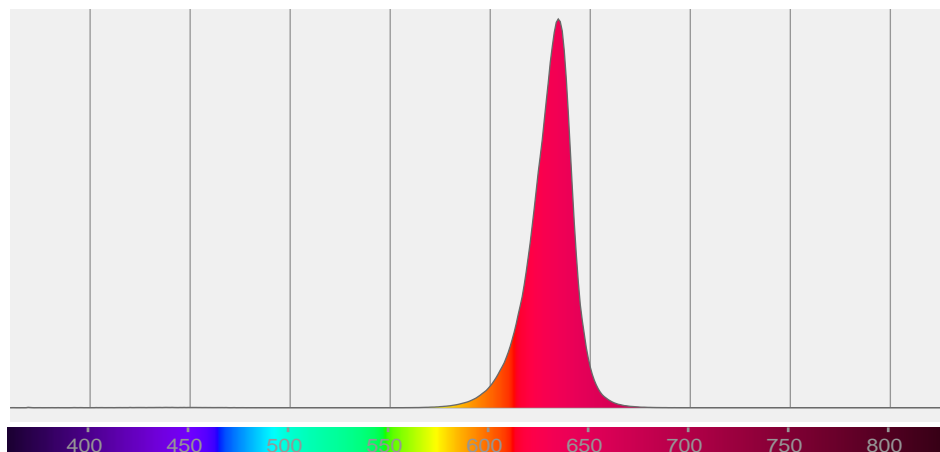

# BEAM DETAILS



Beam angle 50%	Field angle 10%	Cutoff angle 2,5%	Intensity ratio in 120° cone	Intensity ratio in 90° cone
33,1°	53,8°	62,6°	99,4%	98,3%

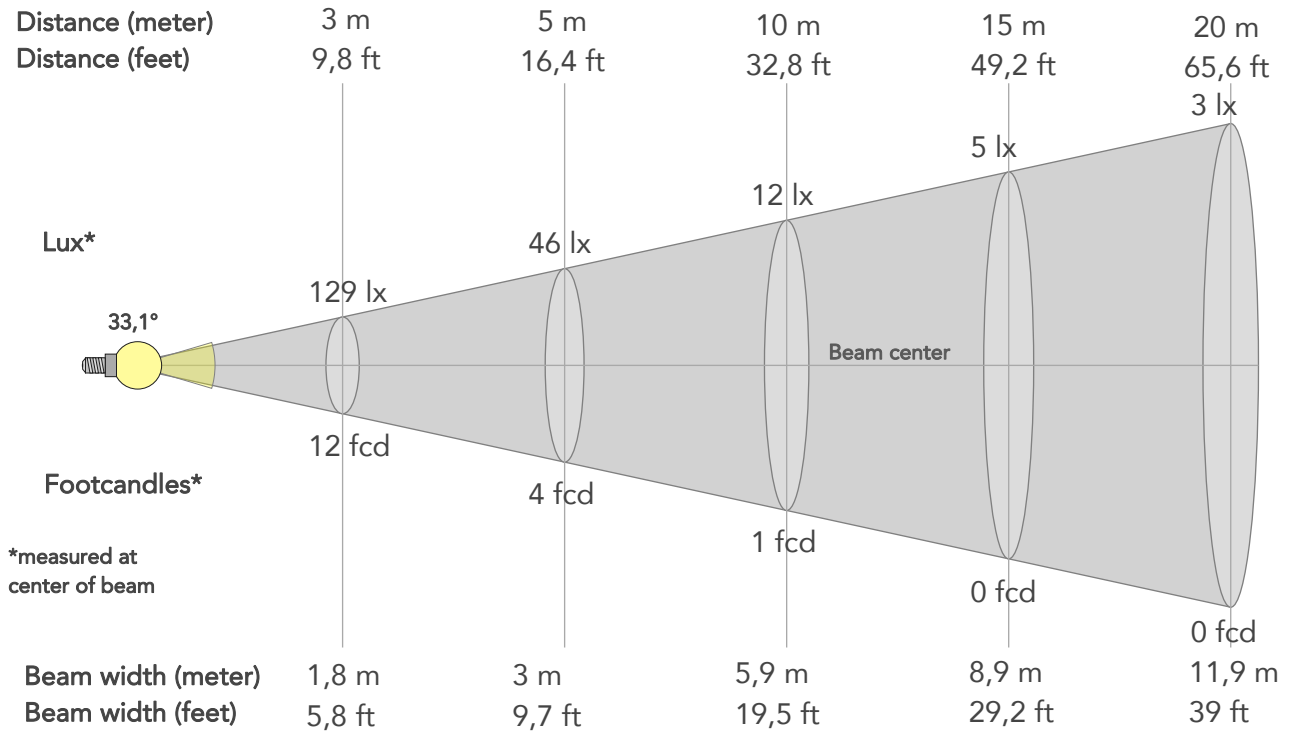

## BEAM INTENSITIES AND WIDTHS

Distance	1m	2m	3m	4m	5m	7,5m	10m	15m	20m	25m	30m	40m	50m
Distance	3,3ft	6,6ft	9,8ft	13,1ft	16,4ft	24,6ft	32,8ft	49,2ft	65,6ft	82ft	98,4ft	131,2ft	164ft
Lux	1158lx	290lx	129lx	72lx	46lx	21lx	12lx	5lx	3lx	2lx	1lx	1lx	0lx
Footcand.	108fcd	27fcd	12fcd	7fcd	4fcd	2fcd	1fcd	0fcd	0fcd	0fcd	0fcd	0fcd	0fcd
Beam wid.	0,6m	1,2m	1,8m	2,4m	3m	4,5m	5,9m	8,9m	11,9m	14,9m	17,8m	23,8m	29,7m
Beam wid.	2ft	3,9ft	5,8ft	7,8ft	9,7ft	14,6ft	19,5ft	29,2ft	39ft	48,7ft	58,5ft	77,9ft	97,4ft

## LINEAR DISTRIBUTION DIAGRAM

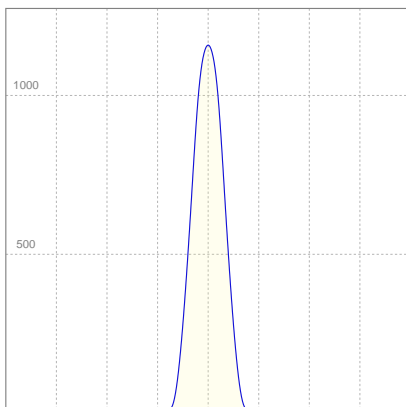

## ELECTRICAL SPECIFICATIONS

Input voltage	Input current	Input power	Effeciency
227V	0,222A	24,5W	16lm/W

## ISO CANDELA DIAGRAM

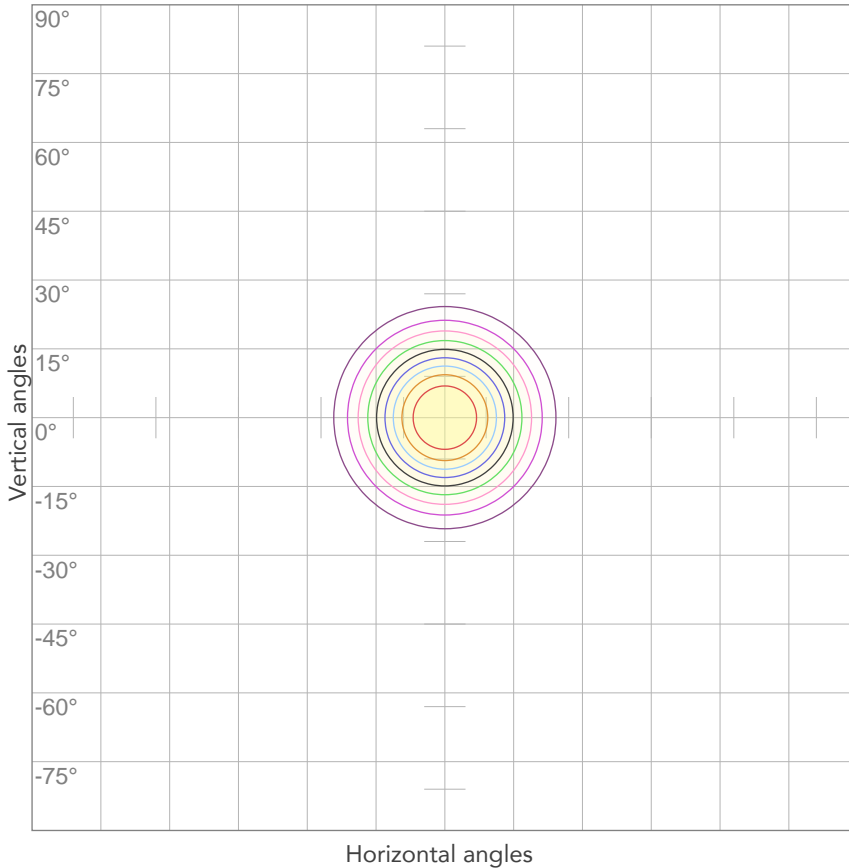

10%	116 cd
20%	232 cd
30%	347 cd
40%	463 cd
50%	579 cd
60%	695 cd
70%	{LUX_1M70} cd
80%	926 cd

**Conditions:**  
 Number of c-planes: 2  
 Candela at center: 1158 cd

## ISO LUX DIAGRAM

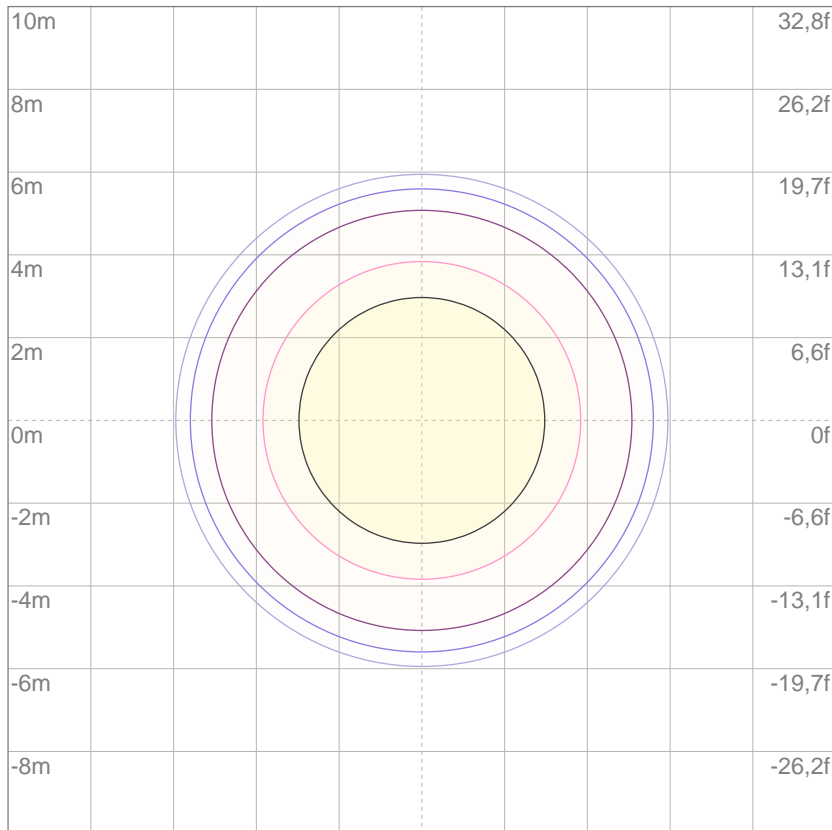

3%	0,347 lx
5%	0,579 lx
10%	1,16 lx
30%	3,47 lx
50%	5,79 lx

**Conditions:**  
 Number of c-planes: 2  
 Lux at center: 11,6 lx

*Lux distribution on a surface when lamp is mounted at 10 meters from the surface.*

Mounting height: 10 meters (33 feet)



Total lumen output:

238 lm

Total candela output:

2120 cd

**PRODUCT NAME:**

EclipseFresnel TW

**MEASUREMENT CONDITIONS:**

Beam angle:

15°

Target:

Red

Operator:

Marco Marrocco

Date and time:

14/12/2019 11:27:04

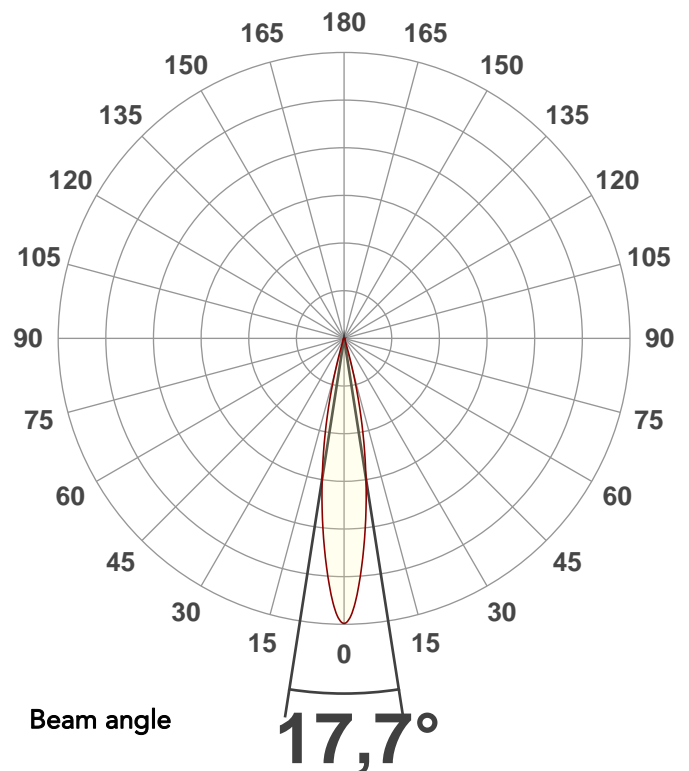

Spectra

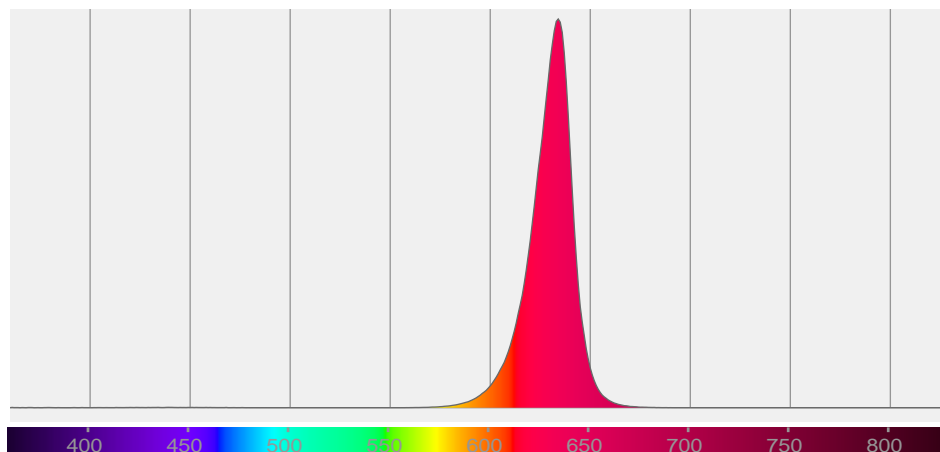

# BEAM DETAILS



Beam angle 50%	Field angle 10%	Cutoff angle 2,5%	Intensity ratio in 120° cone	Intensity ratio in 90° cone
17,7°	31,1°	38,1°	99,2%	97,7%

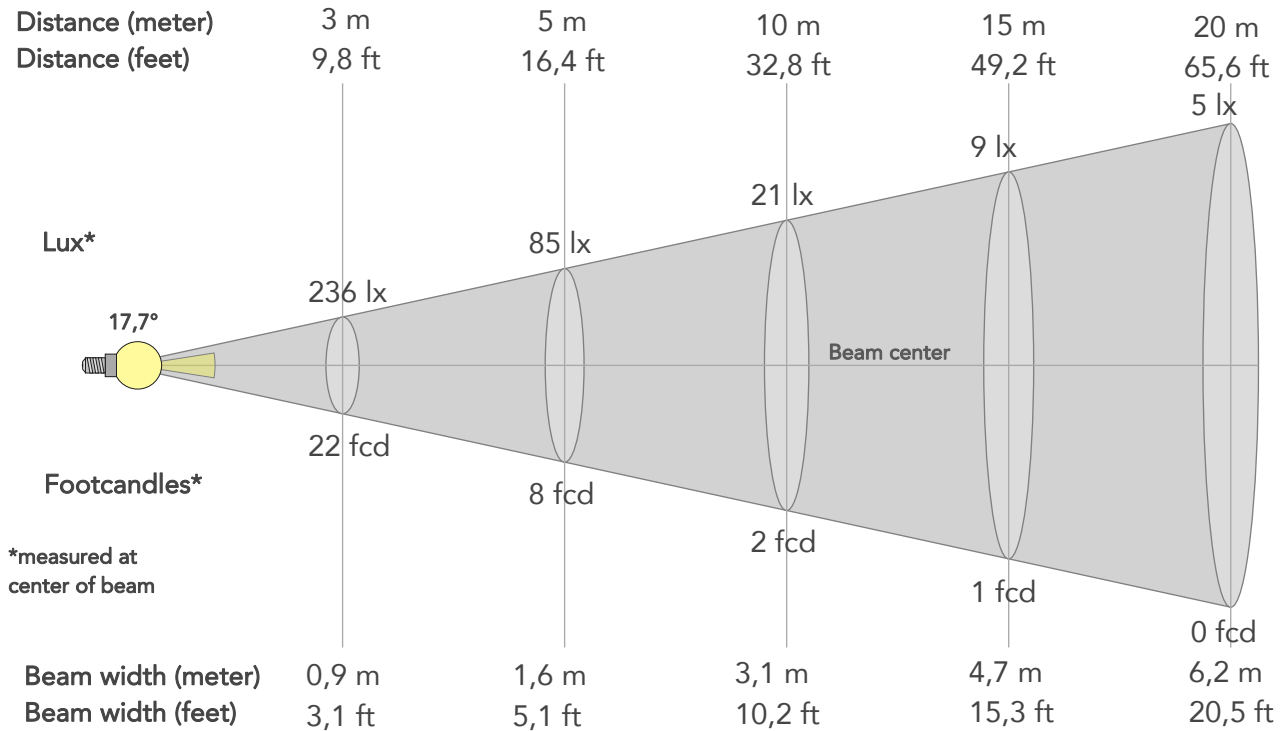

## BEAM INTENSITIES AND WIDTHS

Distance	1m	2m	3m	4m	5m	7,5m	10m	15m	20m	25m	30m	40m	50m
Distance	3,3ft	6,6ft	9,8ft	13,1ft	16,4ft	24,6ft	32,8ft	49,2ft	65,6ft	82ft	98,4ft	131,2ft	164ft
Lux	2120lx	530lx	236lx	132lx	85lx	38lx	21lx	9lx	5lx	3lx	2lx	1lx	1lx
Footcand.	197fcd	49fcd	22fcd	12fcd	8fcd	4fcd	2fcd	1fcd	0fcd	0fcd	0fcd	0fcd	0fcd
Beam wid.	0,3m	0,6m	0,9m	1,2m	1,6m	2,3m	3,1m	4,7m	6,2m	7,8m	9,4m	12,5m	15,6m
Beam wid.	1ft	2,1ft	3,1ft	4,1ft	5,1ft	7,7ft	10,2ft	15,3ft	20,5ft	25,6ft	30,7ft	40,9ft	51,2ft

## LINEAR DISTRIBUTION DIAGRAM

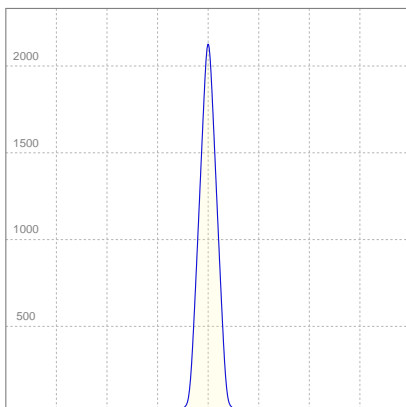

## ELECTRICAL SPECIFICATIONS

Input voltage	Input current	Input power	Efficiency
228V	0,221A	24,4W	10lm/W

## ISO CANDELA DIAGRAM

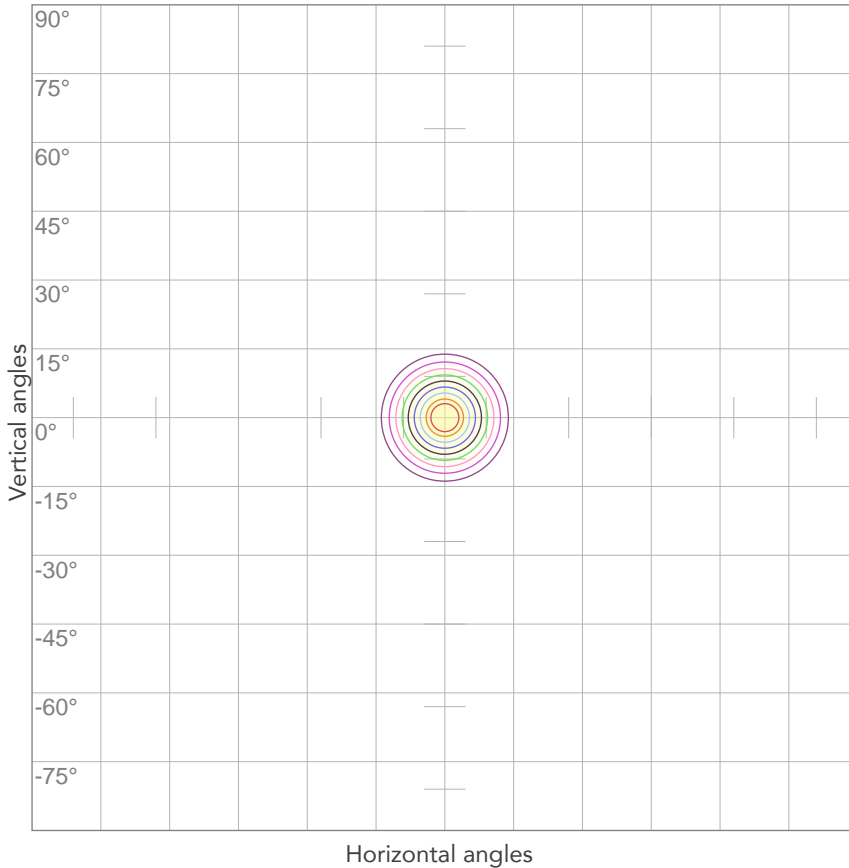

10%	212 cd
20%	424 cd
30%	636 cd
40%	848 cd
50%	1060 cd
60%	1272 cd
70%	{LUX_1M70} cd
80%	1696 cd

Conditions:  
 Number of c-planes: 2  
 Candela at center: 2120 cd

## ISO LUX DIAGRAM

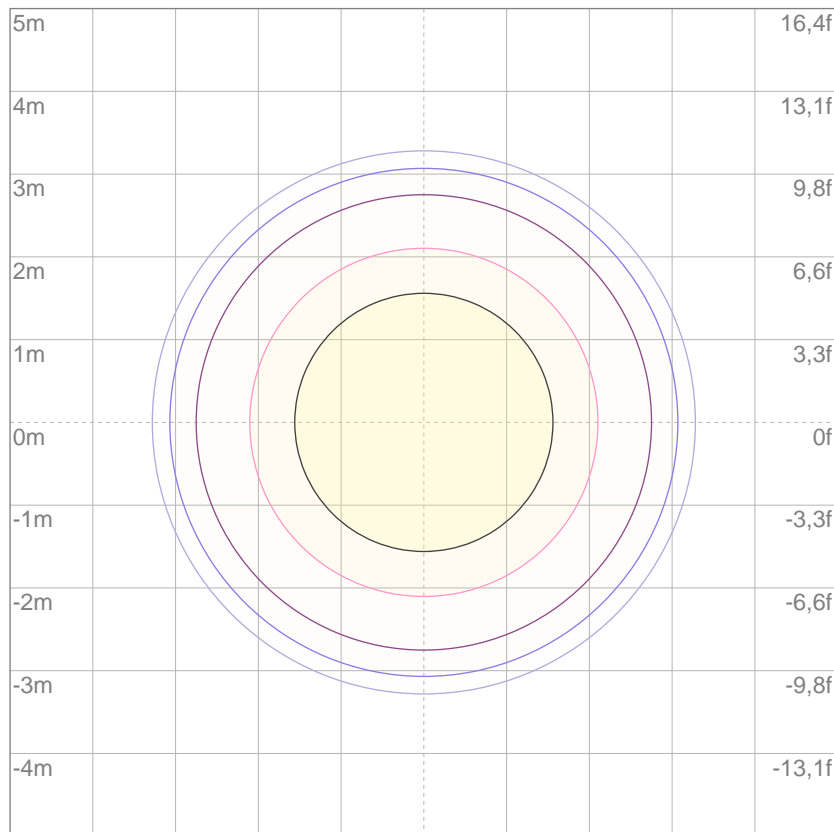

3%	0,636 lx
5%	1,06 lx
10%	2,12 lx
30%	6,36 lx
50%	10,6 lx

Conditions:  
 Number of c-planes: 2  
 Lux at center: 21,2 lx

*Lux distribution on a surface when lamp is mounted at 10 meters from the surface.*

Mounting height: 10 meters (33 feet)



Total lumen output:

1727 lm

Total candela output:

1848 cd

**PRODUCT NAME:**

EclipseFresnel TW

**MEASUREMENT CONDITIONS:**

Beam angle:

45°

Target:

Orange

Operator:

Marco Marrocco

Date and time:

14/12/2019 10:28:36

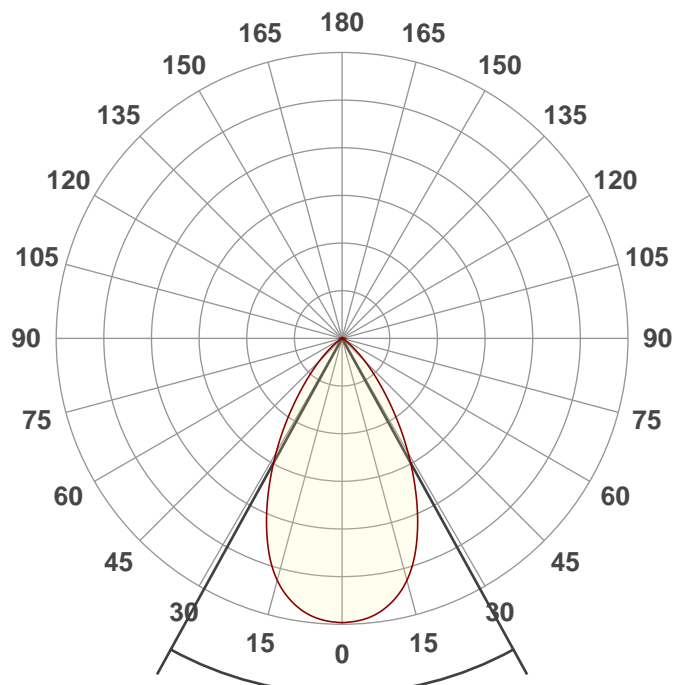

Beam angle

**57,7°**

Spectra

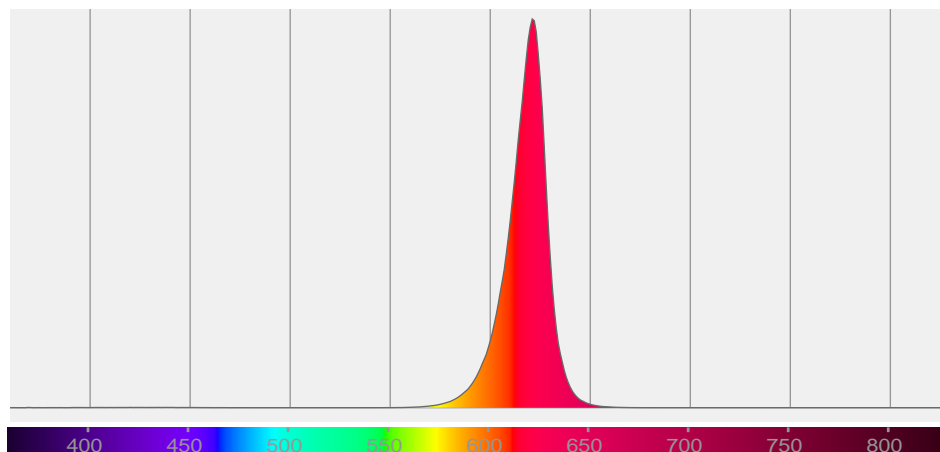

# BEAM DETAILS



Beam angle 50%	Field angle 10%	Cutoff angle 2,5%	Intensity ratio in 120° cone	Intensity ratio in 90° cone
57,7°	92°	107,9°	99,5%	93,8%

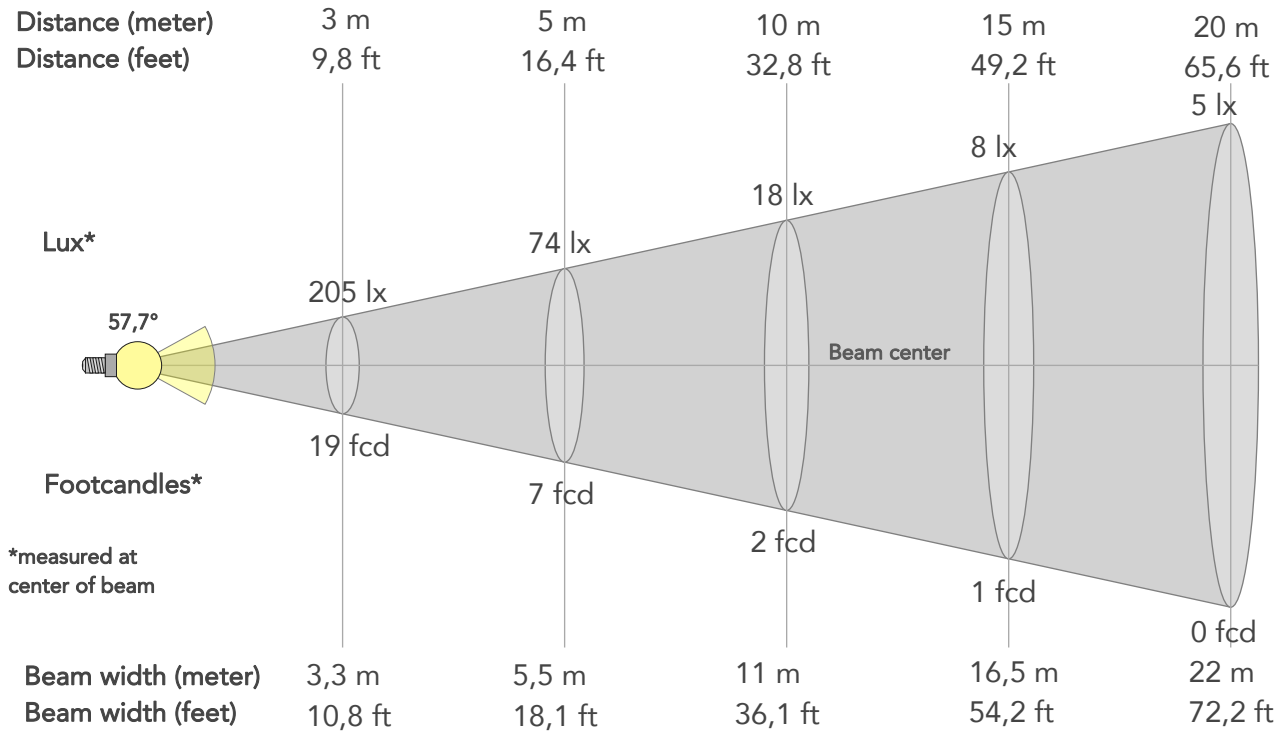

## BEAM INTENSITIES AND WIDTHS

Distance	1m	2m	3m	4m	5m	7,5m	10m	15m	20m	25m	30m	40m	50m
Distance	3,3ft	6,6ft	9,8ft	13,1ft	16,4ft	24,6ft	32,8ft	49,2ft	65,6ft	82ft	98,4ft	131,2ft	164ft
Lux	1848lx	462lx	205lx	116lx	74lx	33lx	18lx	8lx	5lx	3lx	2lx	1lx	1lx
Footcand.	172fcd	43fcd	19fcd	11fcd	7fcd	3fcd	2fcd	1fcd	0fcd	0fcd	0fcd	0fcd	0fcd
Beam wid.	1,1m	2,2m	3,3m	4,4m	5,5m	8,3m	11m	16,5m	22m	27,5m	33m	44m	55,1m
Beam wid.	3,6ft	7,3ft	10,8ft	14,4ft	18,1ft	27,1ft	36,1ft	54,2ft	72,2ft	90,3ft	108,4ft	144,5ft	180,6ft

## LINEAR DISTRIBUTION DIAGRAM

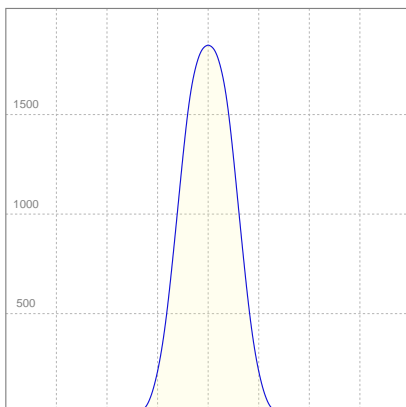

## ELECTRICAL SPECIFICATIONS

Input voltage	Input current	Input power	Effeciency
229V	0,318A	51,8W	33lm/W



## ISO CANDELA DIAGRAM

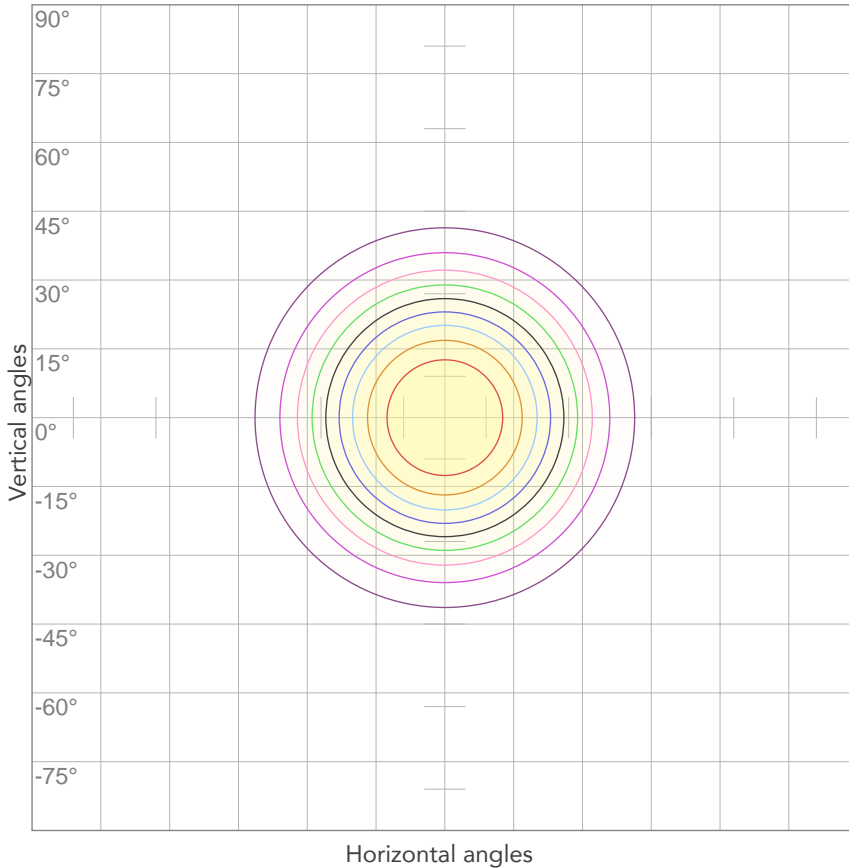

10%	185 cd
20%	370 cd
30%	554 cd
40%	739 cd
50%	924 cd
60%	1109 cd
70%	{LUX_1M70} cd
80%	1479 cd

Conditions:

Number of c-planes: 2

Candela at center: 1848 cd

## ISO LUX DIAGRAM

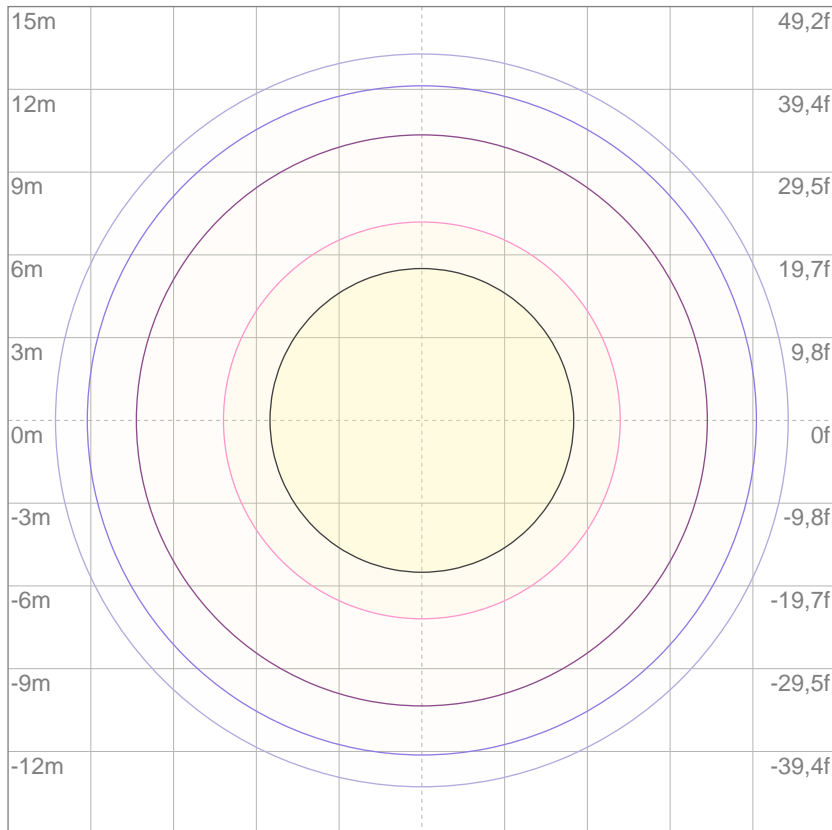

Mounting height: 10 meters (33 feet)

3%	0,554 lx
5%	0,924 lx
10%	1,85 lx
30%	5,54 lx
50%	9,24 lx

Conditions:

Number of c-planes: 2

Lux at center: 18,5 lx

*Lux distribution on a surface when lamp is mounted at 10 meters from the surface.*



Total lumen output:

1567 lm

Total candela output:

4971 cd

**PRODUCT NAME:**

EclipseFresnel TW

**MEASUREMENT CONDITIONS:**

Beam angle:

30°

Target:

Orange

Operator:

Marco Marrocco

Date and time:

14/12/2019 12:06:18

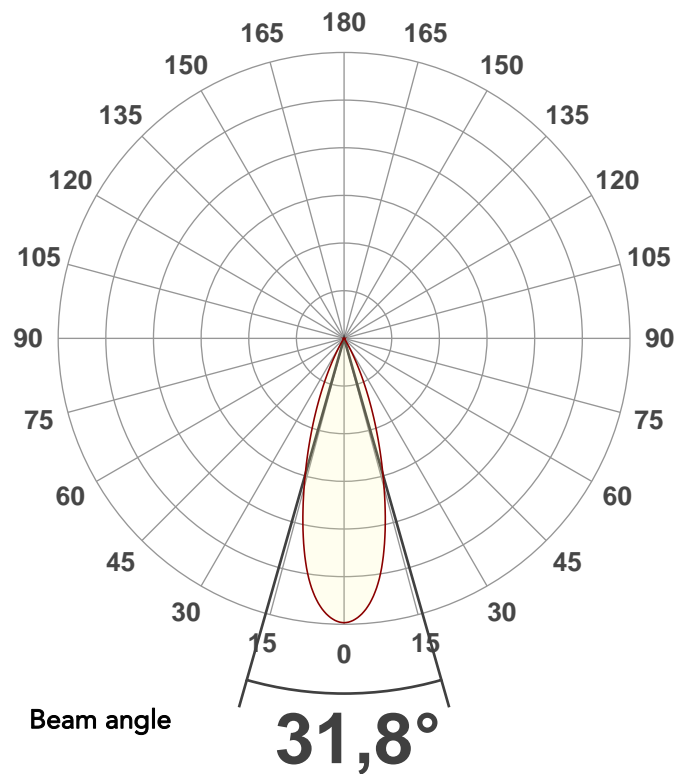

Spectra

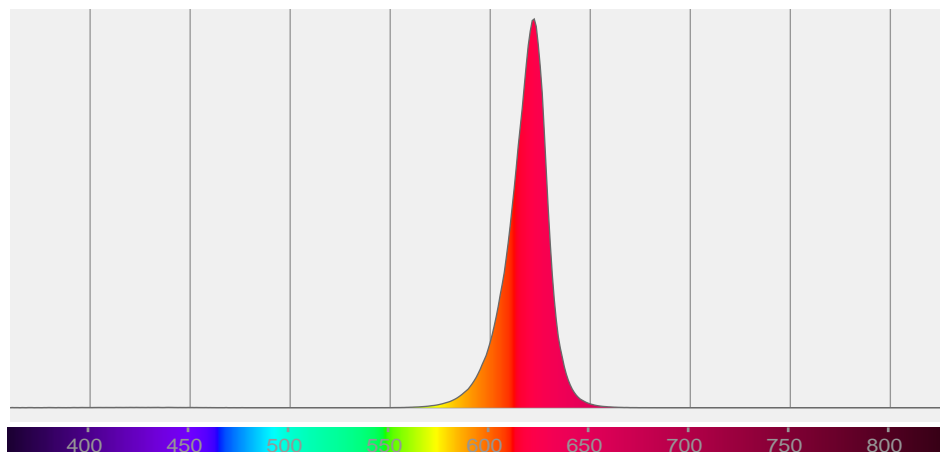

# BEAM DETAILS



Beam angle 50%	Field angle 10%	Cutoff angle 2,5%	Intensity ratio in 120° cone	Intensity ratio in 90° cone
31,8°	53,2°	62,2°	99,4%	98,2%

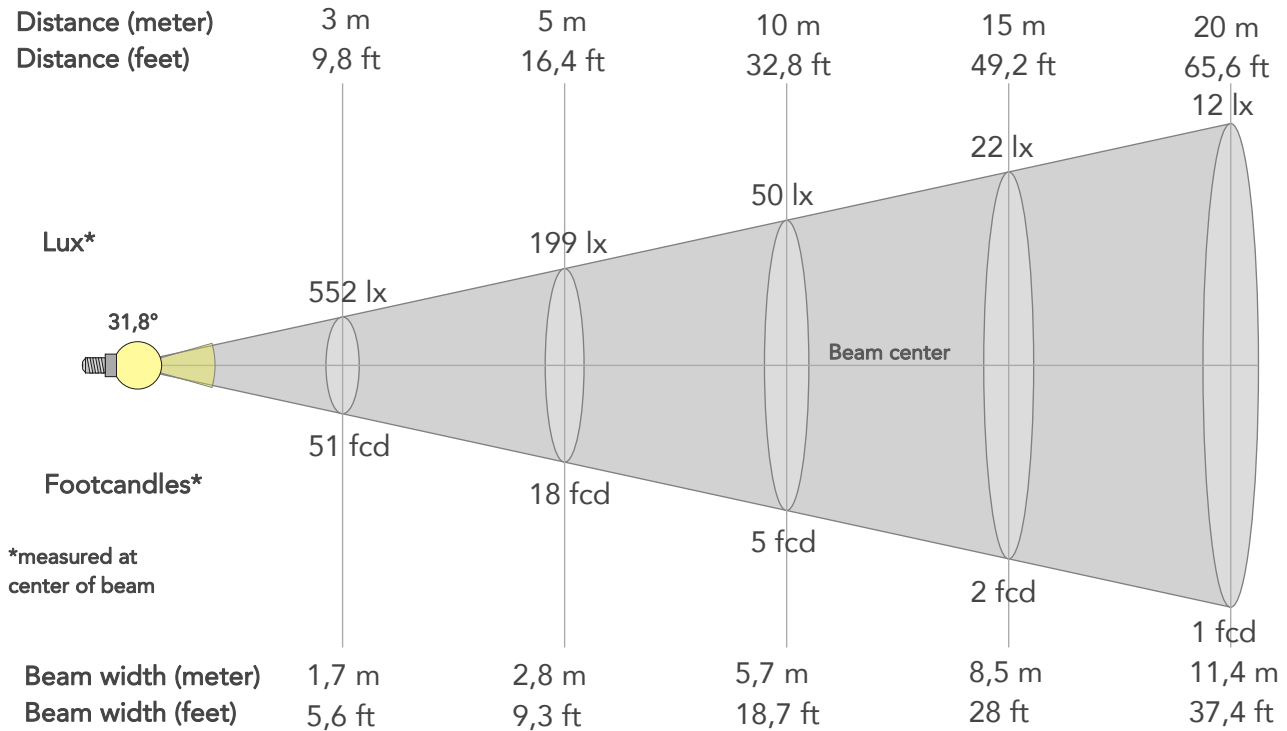

## BEAM INTENSITIES AND WIDTHS

Distance	1m	2m	3m	4m	5m	7,5m	10m	15m	20m	25m	30m	40m	50m
Distance	3,3ft	6,6ft	9,8ft	13,1ft	16,4ft	24,6ft	32,8ft	49,2ft	65,6ft	82ft	98,4ft	131,2ft	164ft
Lux	4971lx	1243lx	552lx	311lx	199lx	88lx	50lx	22lx	12lx	8lx	6lx	3lx	2lx
Footcand.	462fcd	115fcd	51fcd	29fcd	18fcd	8fcd	5fcd	2fcd	1fcd	1fcd	1fcd	0fcd	0fcd
Beam wid.	0,6m	1,1m	1,7m	2,3m	2,8m	4,3m	5,7m	8,5m	11,4m	14,2m	17,1m	22,8m	28,5m
Beam wid.	1,9ft	3,8ft	5,6ft	7,5ft	9,3ft	14ft	18,7ft	28ft	37,4ft	46,7ft	56,1ft	74,8ft	93,4ft

## LINEAR DISTRIBUTION DIAGRAM

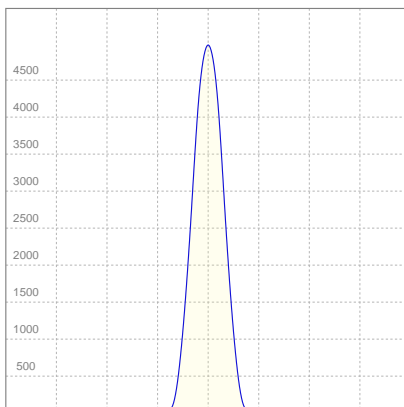

## ELECTRICAL SPECIFICATIONS

Input voltage	Input current	Input power	Effeciency
227V	0,320A	52,0W	30lm/W

## ISO CANDELA DIAGRAM

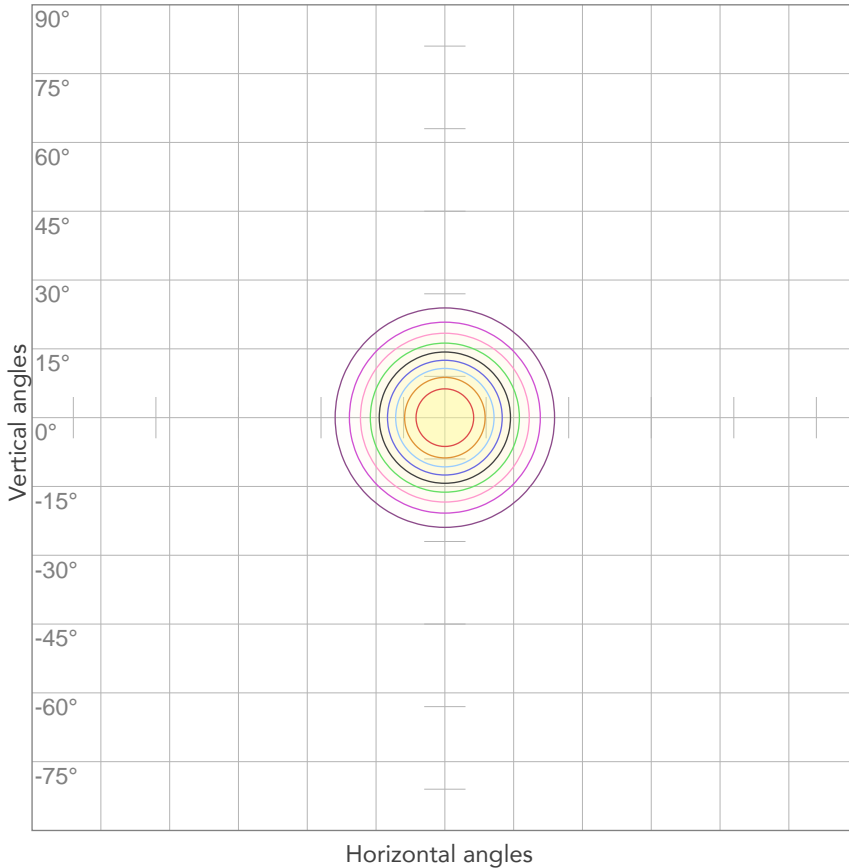

10%	497 cd
20%	994 cd
30%	1491 cd
40%	1988 cd
50%	2486 cd
60%	2983 cd
70%	{LUX_1M70} cd
80%	3977 cd

Conditions:

Number of c-planes: 2

Candela at center: 4971 cd

## ISO LUX DIAGRAM

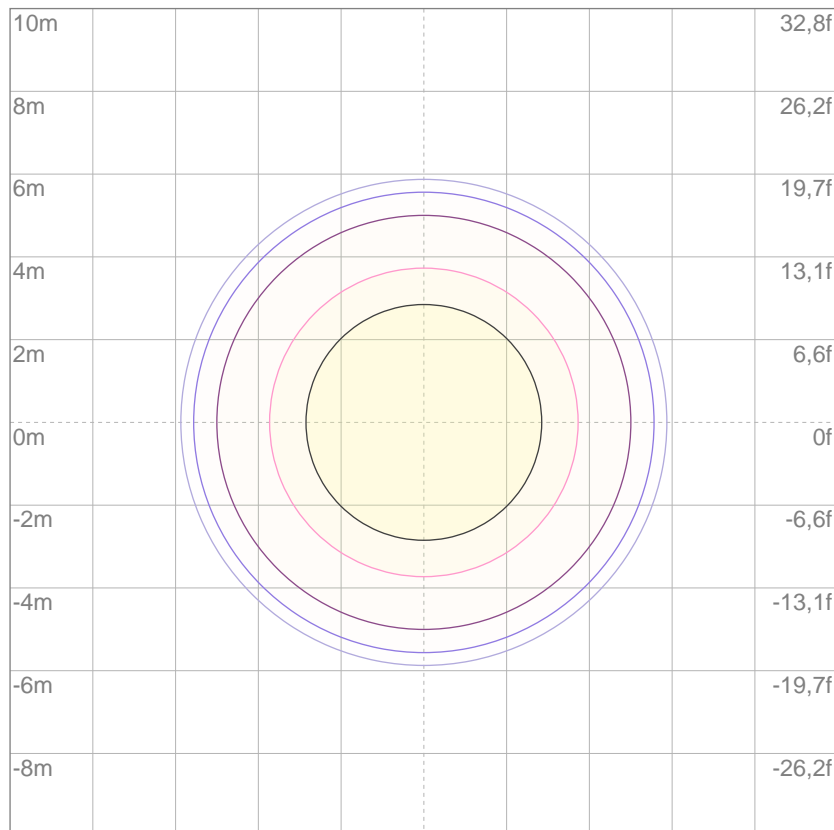

Mounting height: 10 meters (33 feet)

3%	1,49 lx
5%	2,49 lx
10%	4,97 lx
30%	14,9 lx
50%	24,9 lx

Conditions:

Number of c-planes: 2

Lux at center: 49,7 lx

*Lux distribution on a surface when lamp is mounted at 10 meters from the surface.*



Total lumen output:

997 lm

Total candela output:

9030 cd

**PRODUCT NAME:**

EclipseFresnel TW

**MEASUREMENT CONDITIONS:**

Beam angle:

15°

Target:

Orange

Operator:

Marco Marrocco

Date and time:

14/12/2019 11:29:50

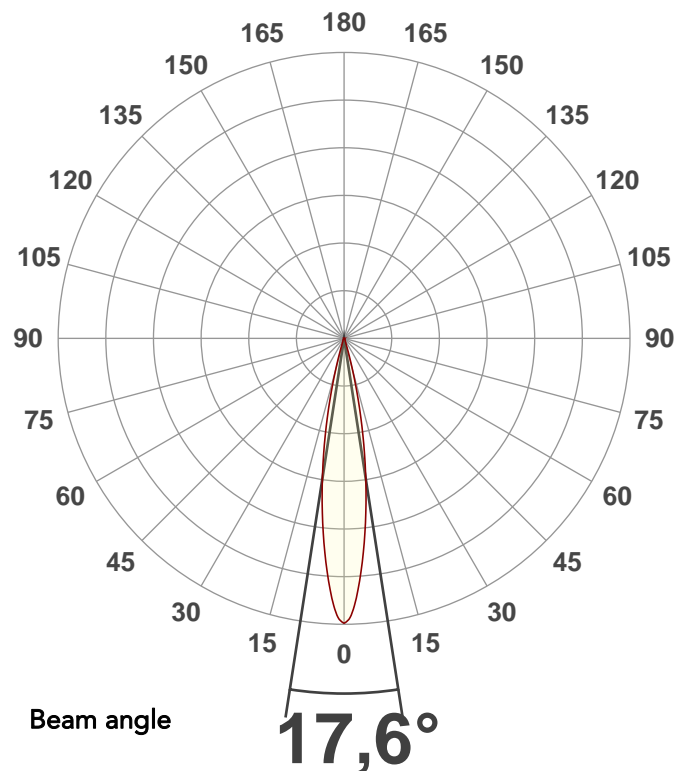

Spectra

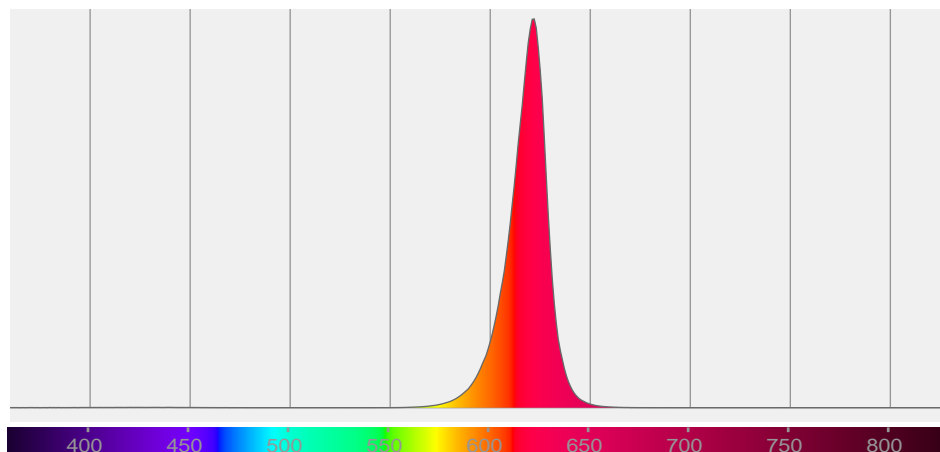

# BEAM DETAILS



Beam angle 50%	Field angle 10%	Cutoff angle 2,5%	Intensity ratio in 120° cone	Intensity ratio in 90° cone
17,6°	30,8°	37,8°	99,1%	97,6%

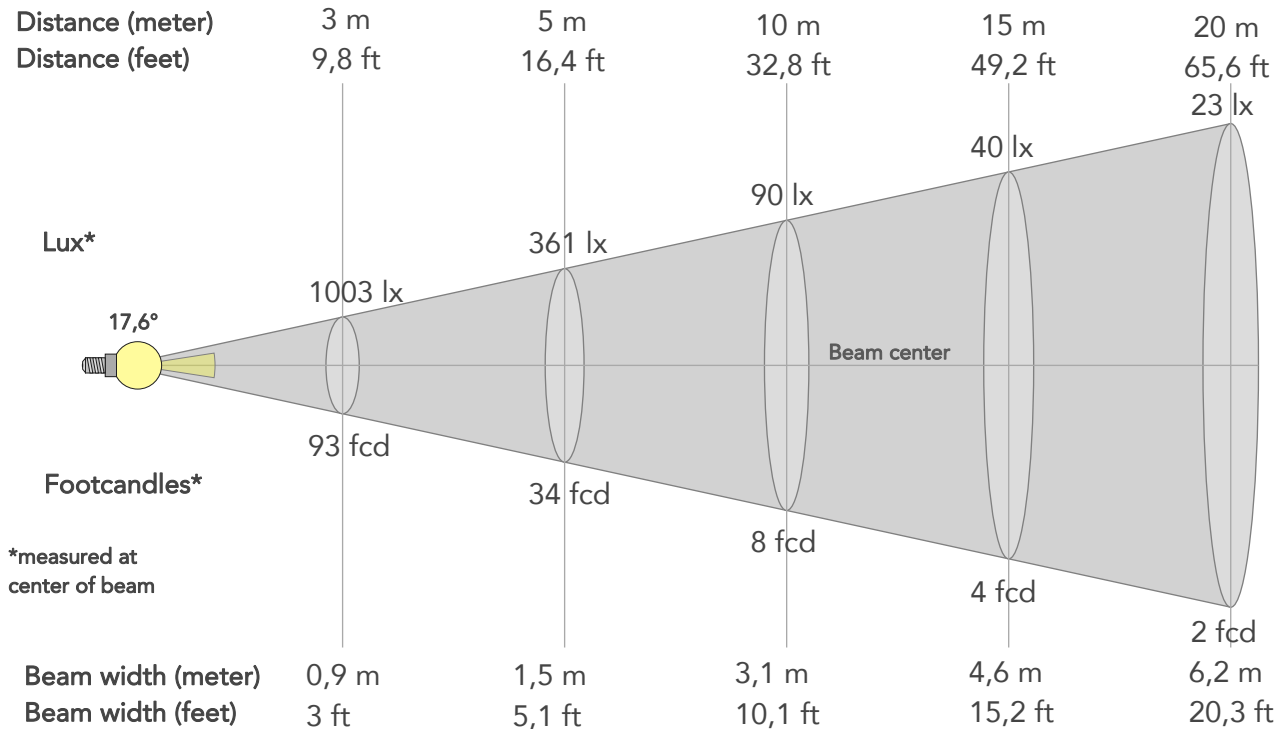

## BEAM INTENSITIES AND WIDTHS

Distance	1m	2m	3m	4m	5m	7,5m	10m	15m	20m	25m	30m	40m	50m
Distance	3,3ft	6,6ft	9,8ft	13,1ft	16,4ft	24,6ft	32,8ft	49,2ft	65,6ft	82ft	98,4ft	131,2ft	164ft
Lux	9030lx	2257lx	1003lx	564lx	361lx	161lx	90lx	40lx	23lx	14lx	10lx	6lx	4lx
Footcand.	839fcd	210fcd	93fcd	52fcd	34fcd	15fcd	8fcd	4fcd	2fcd	1fcd	1fcd	1fcd	0fcd
Beam wid.	0,3m	0,6m	0,9m	1,2m	1,5m	2,3m	3,1m	4,6m	6,2m	7,7m	9,3m	12,4m	15,4m
Beam wid.	1ft	2ft	3ft	4ft	5,1ft	7,6ft	10,1ft	15,2ft	20,3ft	25,3ft	30,4ft	40,5ft	50,7ft

## LINEAR DISTRIBUTION DIAGRAM

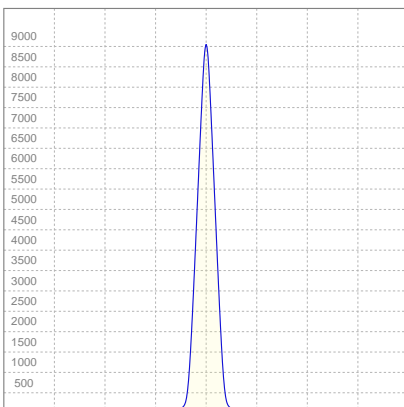

## ELECTRICAL SPECIFICATIONS

Input voltage	Input current	Input power	Efficiency
229V	0,319A	51,9W	19lm/W

## ISO CANDELA DIAGRAM

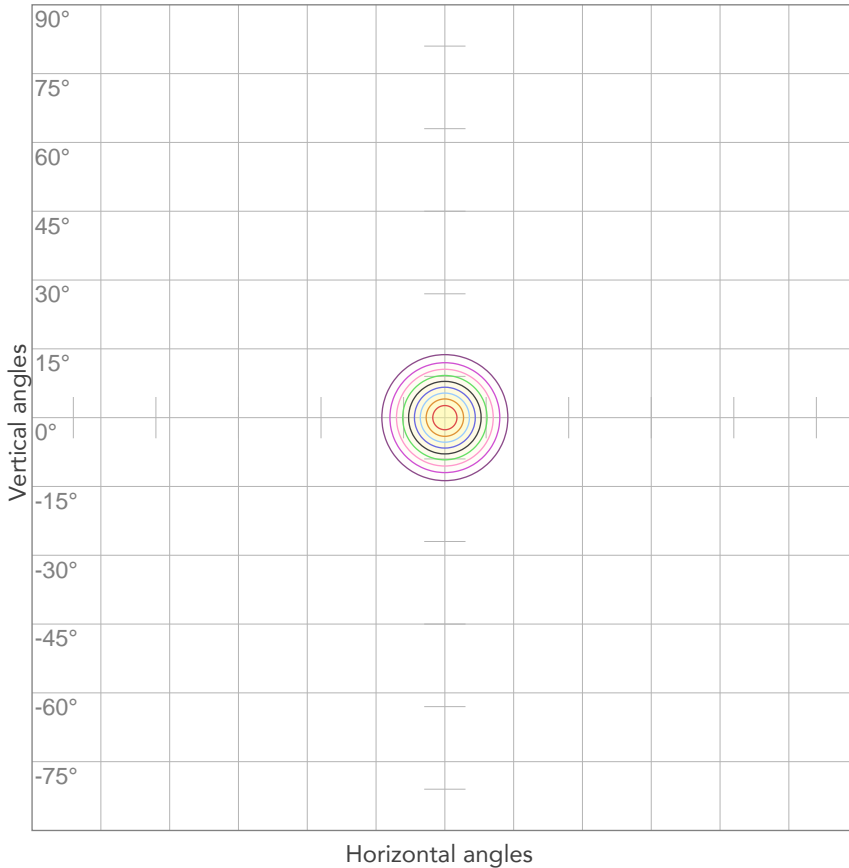

10%	903 cd
20%	1806 cd
30%	2709 cd
40%	3612 cd
50%	4515 cd
60%	5418 cd
70%	{LUX_1M70} cd
80%	7224 cd

Conditions:

Number of c-planes: 2

Candela at center: 9030 cd

## ISO LUX DIAGRAM

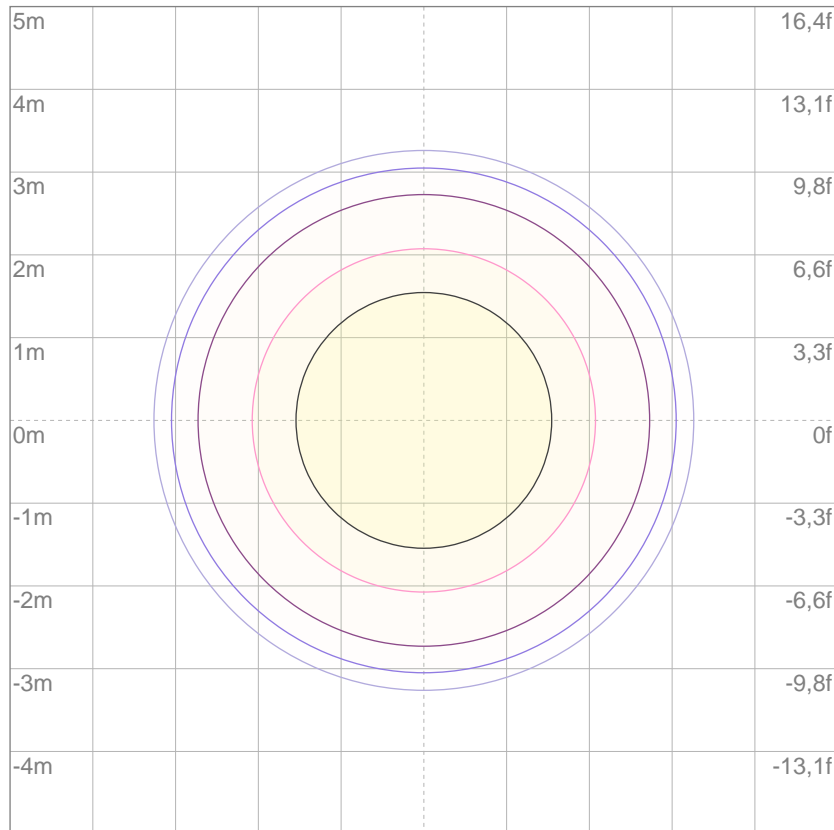

3%	2,71 lx
5%	4,51 lx
10%	9,03 lx
30%	27,1 lx
50%	45,1 lx

Conditions:

Number of c-planes: 2

Lux at center: 90,3 lx

*Lux distribution on a surface when lamp is mounted at 10 meters from the surface.*



Total lumen output:

390 lm

Total candela output:

374 cd

**PRODUCT NAME:**

EclipseFresnel TW

**MEASUREMENT CONDITIONS:**

Beam angle:

45°

Target:

Green

Operator:

Marco Marrocco

Date and time:

14/12/2019 10:31:35

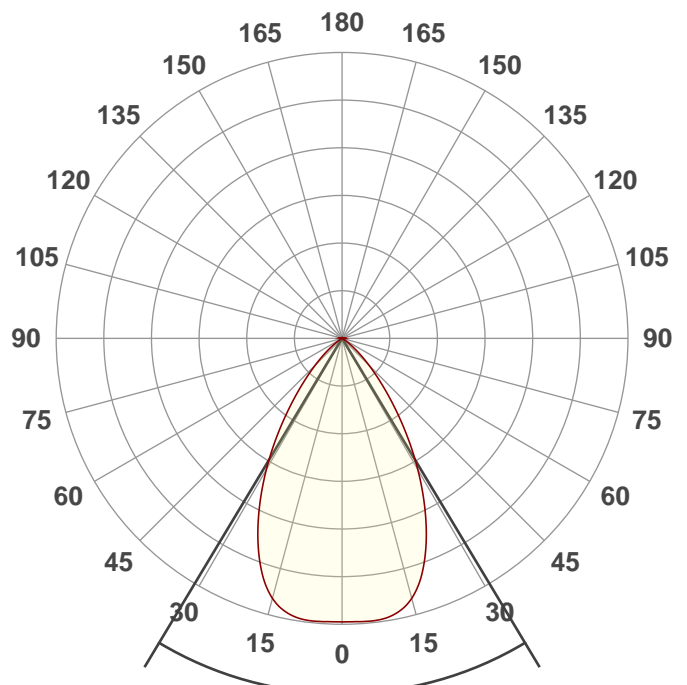

Beam angle

**62°**

Spectra

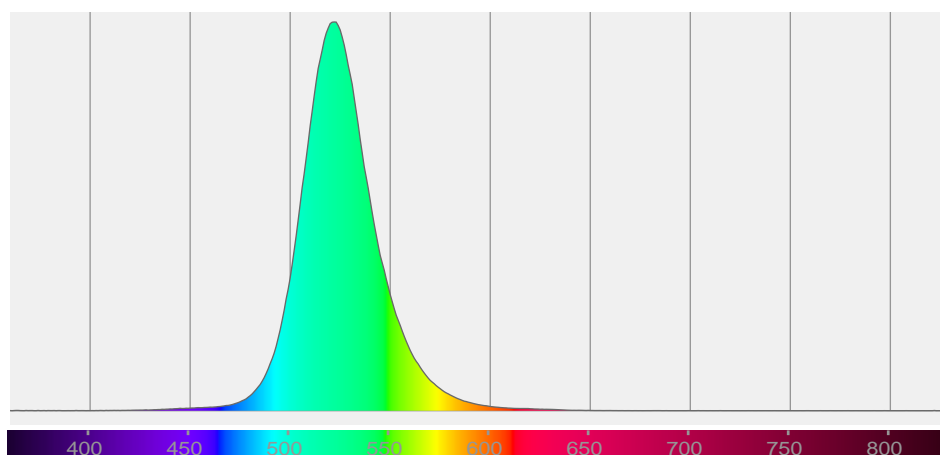



# BEAM DETAILS



Beam angle 50%	Field angle 10%	Cutoff angle 2,5%	Intensity ratio in 120° cone	Intensity ratio in 90° cone
62°	94,5°	109,7°	99,5%	93,3%

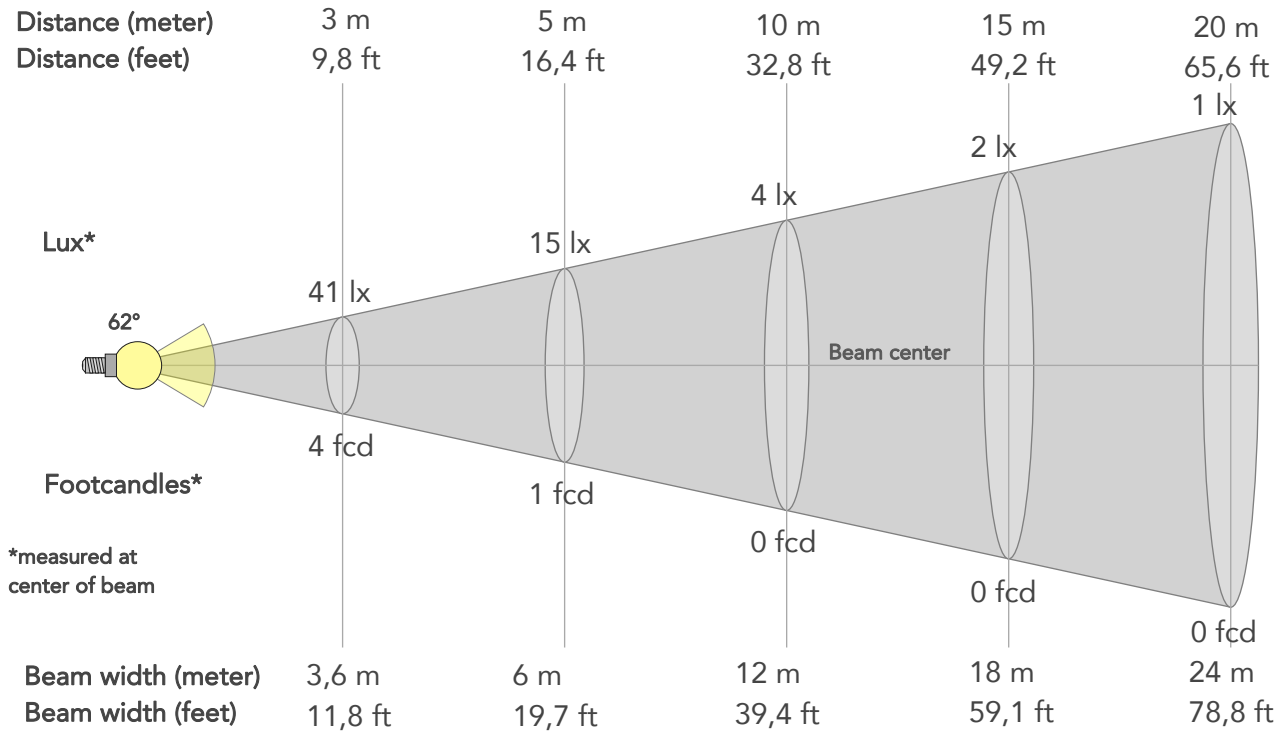

## BEAM INTENSITIES AND WIDTHS

Distance	1m	2m	3m	4m	5m	7,5m	10m	15m	20m	25m	30m	40m	50m
Distance	3,3ft	6,6ft	9,8ft	13,1ft	16,4ft	24,6ft	32,8ft	49,2ft	65,6ft	82ft	98,4ft	131,2ft	164ft
Lux	373lx	93lx	41lx	23lx	15lx	7lx	4lx	2lx	1lx	1lx	0lx	0lx	0lx
Footcand.	35fcd	9fcd	4fcd	2fcd	1fcd	1fcd	0fcd	0fcd	0fcd	0fcd	0fcd	0fcd	0fcd
Beam wid.	1,2m	2,4m	3,6m	4,8m	6m	9m	12m	18m	24m	30m	36,1m	48,1m	60,1m
Beam wid.	4ft	7,9ft	11,8ft	15,7ft	19,7ft	29,6ft	39,4ft	59,1ft	78,8ft	98,5ft	118,3ft	157,7ft	197,1ft

## LINEAR DISTRIBUTION DIAGRAM

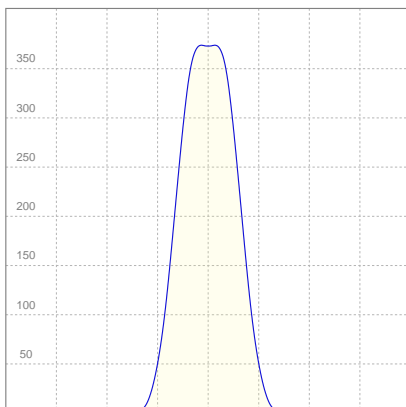

## ELECTRICAL SPECIFICATIONS

Input voltage	Input current	Input power	Effeciency
228V	0,216A	23,4W	17lm/W

## ISO CANDELA DIAGRAM

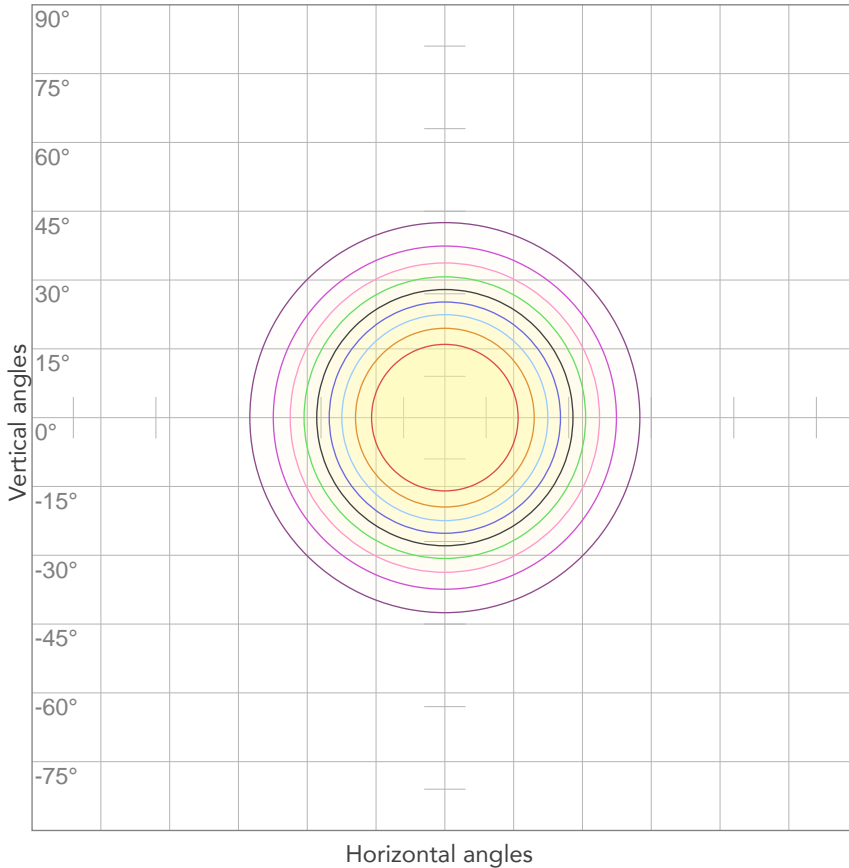

10%	37 cd
20%	75 cd
30%	112 cd
40%	149 cd
50%	187 cd
60%	224 cd
70%	{LUX_1M70} cd
80%	298 cd

**Conditions:**  
 Number of c-planes: 2  
 Candela at center: 373 cd

## ISO LUX DIAGRAM

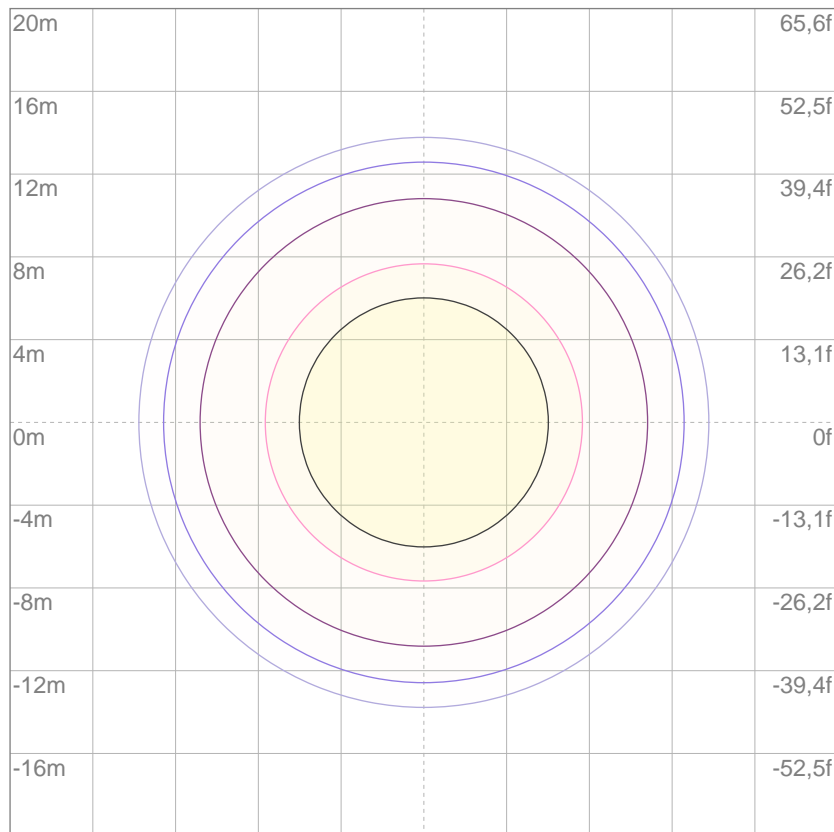

3%	0,112 lx
5%	0,187 lx
10%	0,373 lx
30%	1,12 lx
50%	1,87 lx

**Conditions:**  
 Number of c-planes: 2  
 Lux at center: 3,73 lx

*Lux distribution on a surface when lamp is mounted at 10 meters from the surface.*

Mounting height: 10 meters (33 feet)



Total lumen output:

359 lm

Total candela output:

1083 cd

**PRODUCT NAME:**

EclipseFresnel TW

**MEASUREMENT CONDITIONS:**

Beam angle:

30°

Target:

Green

Operator:

Marco Marrocco

Date and time:

14/12/2019 12:08:30

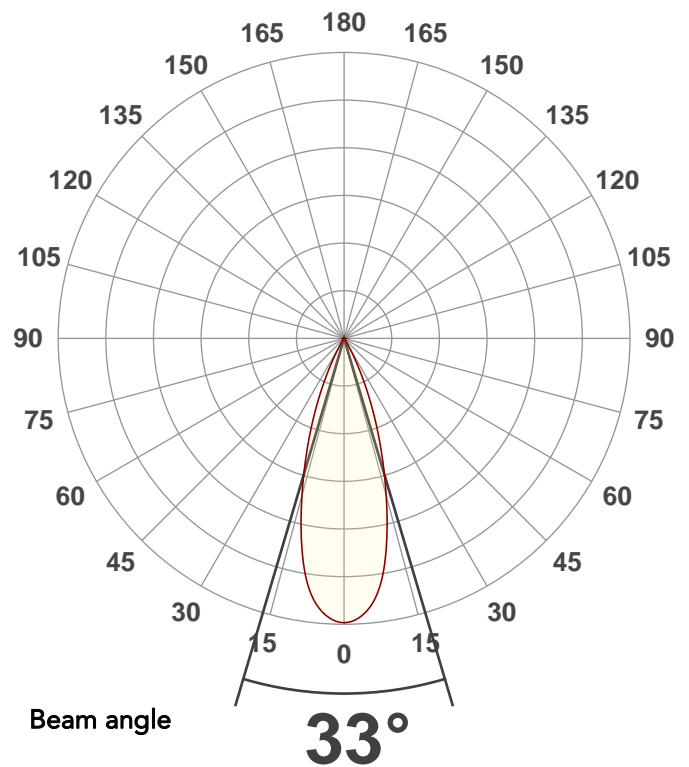

Spectra

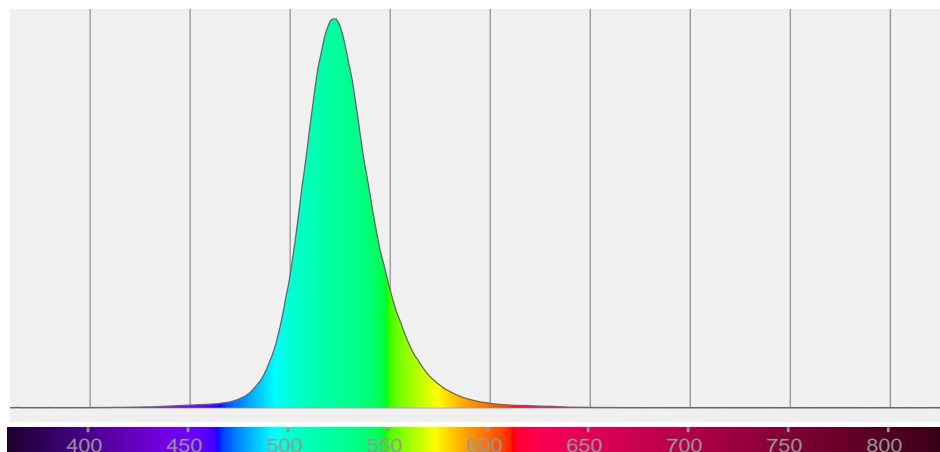

# BEAM DETAILS



Beam angle 50%	Field angle 10%	Cutoff angle 2,5%	Intensity ratio in 120° cone	Intensity ratio in 90° cone
33°	53,9°	62,5°	99,3%	98,1%

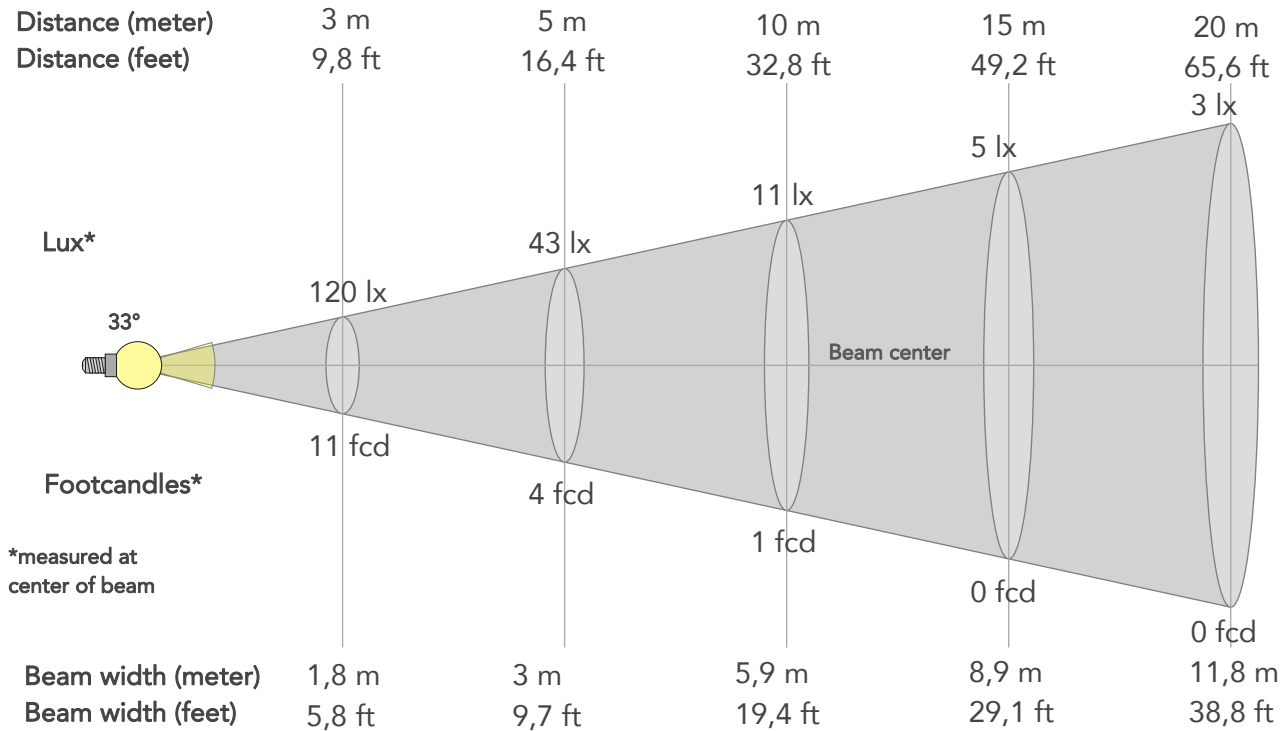

## BEAM INTENSITIES AND WIDTHS

Distance	1m	2m	3m	4m	5m	7,5m	10m	15m	20m	25m	30m	40m	50m
Distance	3,3ft	6,6ft	9,8ft	13,1ft	16,4ft	24,6ft	32,8ft	49,2ft	65,6ft	82ft	98,4ft	131,2ft	164ft
Lux	1083lx	271lx	120lx	68lx	43lx	19lx	11lx	5lx	3lx	2lx	1lx	1lx	0lx
Footcand.	101fcd	25fcd	11fcd	6fcd	4fcd	2fcd	1fcd	0fcd	0fcd	0fcd	0fcd	0fcd	0fcd
Beam wid.	0,6m	1,2m	1,8m	2,4m	3m	4,4m	5,9m	8,9m	11,8m	14,8m	17,8m	23,7m	29,6m
Beam wid.	2ft	3,9ft	5,8ft	7,8ft	9,7ft	14,6ft	19,4ft	29,1ft	38,8ft	48,5ft	58,3ft	77,7ft	97,1ft

## LINEAR DISTRIBUTION DIAGRAM

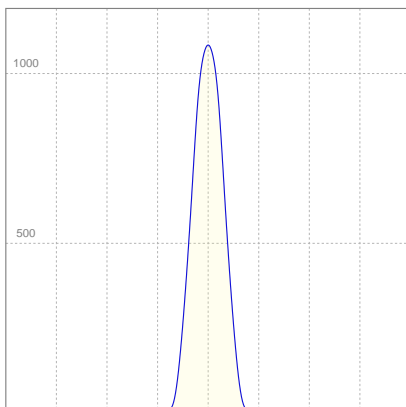

## ELECTRICAL SPECIFICATIONS

Input voltage	Input current	Input power	Effeciency
227V	0,217A	23,5W	15lm/W

## ISO CANDELA DIAGRAM

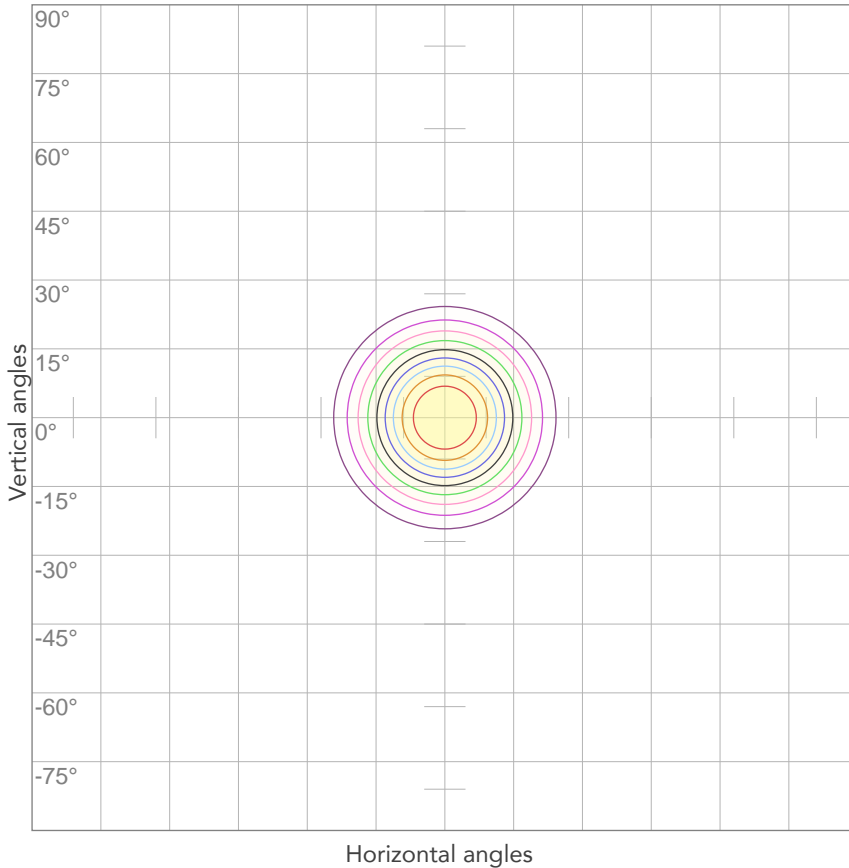

10%	108 cd
20%	217 cd
30%	325 cd
40%	433 cd
50%	542 cd
60%	650 cd
70%	{LUX_1M70} cd
80%	867 cd

**Conditions:**  
 Number of c-planes: 2  
 Candela at center: 1083 cd

## ISO LUX DIAGRAM

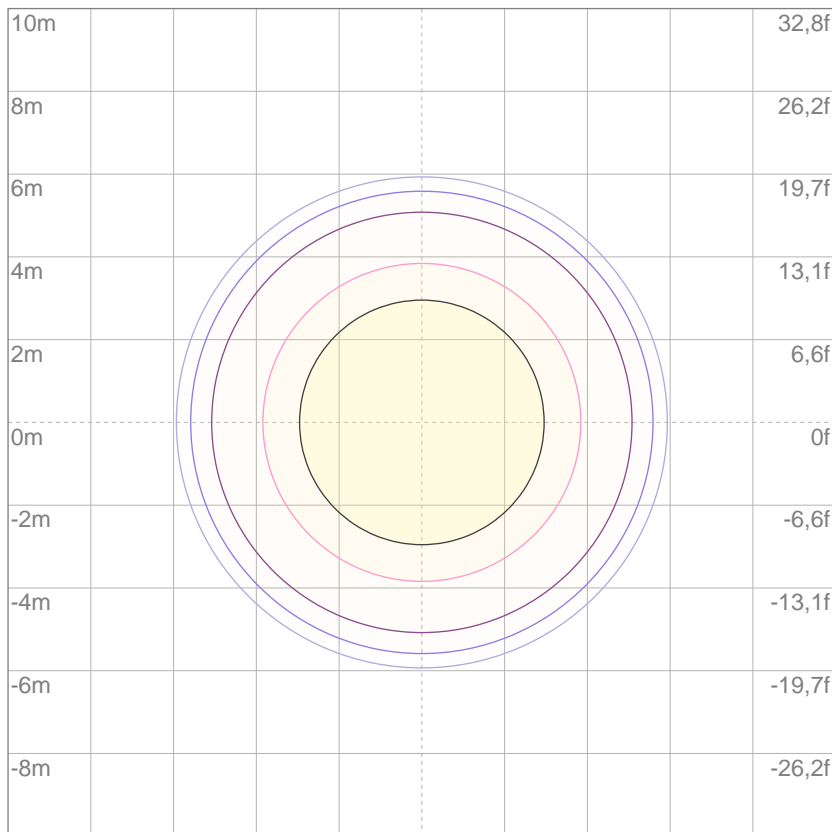

3%	0,325 lx
5%	0,542 lx
10%	1,08 lx
30%	3,25 lx
50%	5,42 lx

**Conditions:**  
 Number of c-planes: 2  
 Lux at center: 10,8 lx

*Lux distribution on a surface when lamp is mounted at 10 meters from the surface.*

Mounting height: 10 meters (33 feet)



Total lumen output:

222 lm

Total candela output:

1917 cd

**PRODUCT NAME:**

EclipseFresnel TW

**MEASUREMENT CONDITIONS:**

Beam angle:

15°

Target:

Green

Operator:

Marco Marrocco

Date and time:

14/12/2019 11:35:52

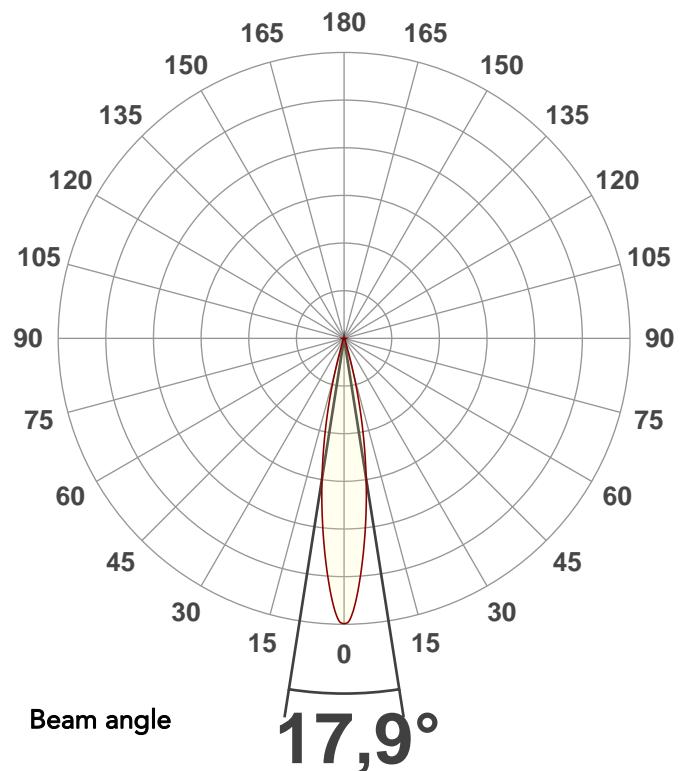

Spectra

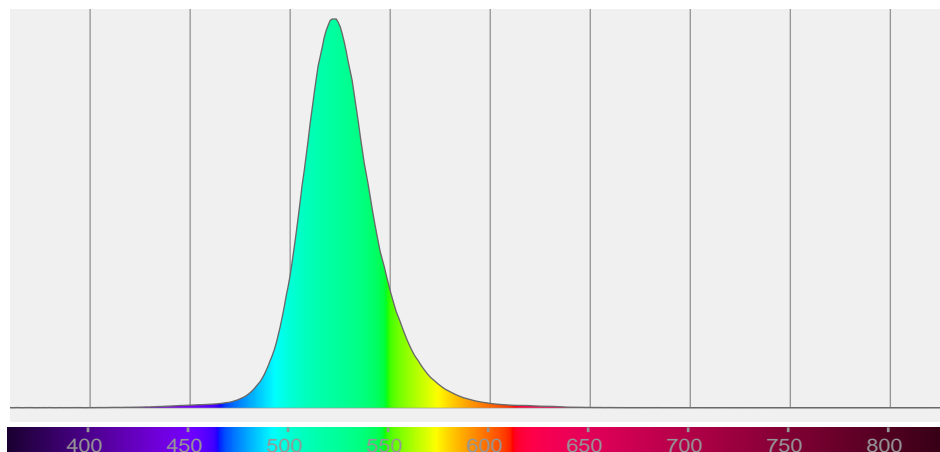

# BEAM DETAILS



Beam angle 50%	Field angle 10%	Cutoff angle 2,5%	Intensity ratio in 120° cone	Intensity ratio in 90° cone
17,9°	31,4°	39°	99,0%	97,3%

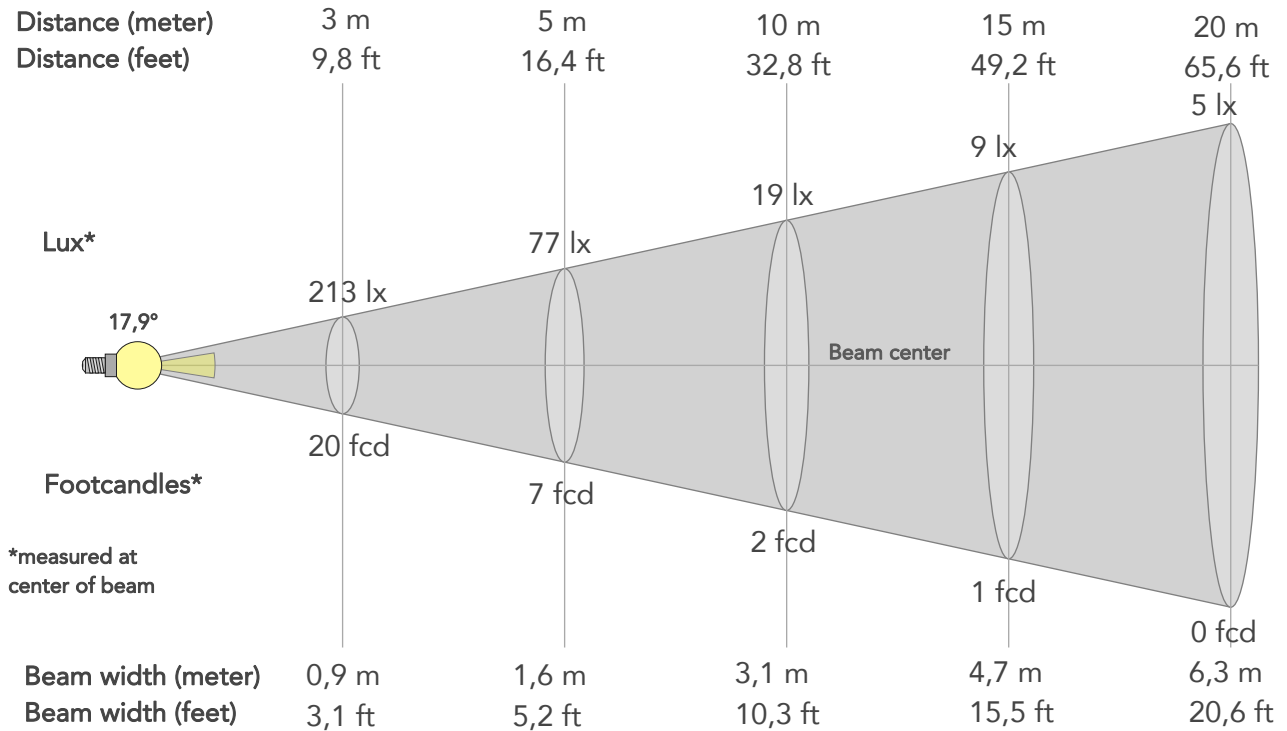

## BEAM INTENSITIES AND WIDTHS

Distance	1m	2m	3m	4m	5m	7,5m	10m	15m	20m	25m	30m	40m	50m
Distance	3,3ft	6,6ft	9,8ft	13,1ft	16,4ft	24,6ft	32,8ft	49,2ft	65,6ft	82ft	98,4ft	131,2ft	164ft
Lux	1917lx	479lx	213lx	120lx	77lx	34lx	19lx	9lx	5lx	3lx	2lx	1lx	1lx
Footcand.	178fcd	45fcd	20fcd	11fcd	7fcd	3fcd	2fcd	1fcd	0fcd	0fcd	0fcd	0fcd	0fcd
Beam wid.	0,3m	0,6m	0,9m	1,3m	1,6m	2,4m	3,1m	4,7m	6,3m	7,9m	9,4m	12,6m	15,7m
Beam wid.	1ft	2,1ft	3,1ft	4,1ft	5,2ft	7,7ft	10,3ft	15,5ft	20,6ft	25,8ft	30,9ft	41,3ft	51,6ft

## LINEAR DISTRIBUTION DIAGRAM

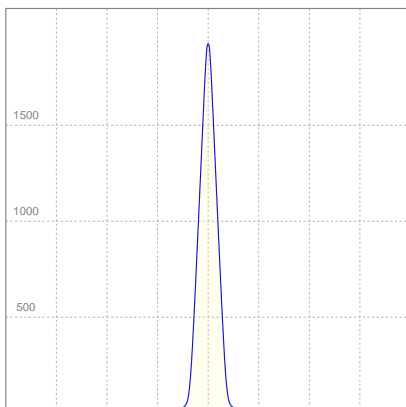

## ELECTRICAL SPECIFICATIONS

Input voltage	Input current	Input power	Effeciency
229V	0,219A	23,6W	9lm/W

## ISO CANDELA DIAGRAM

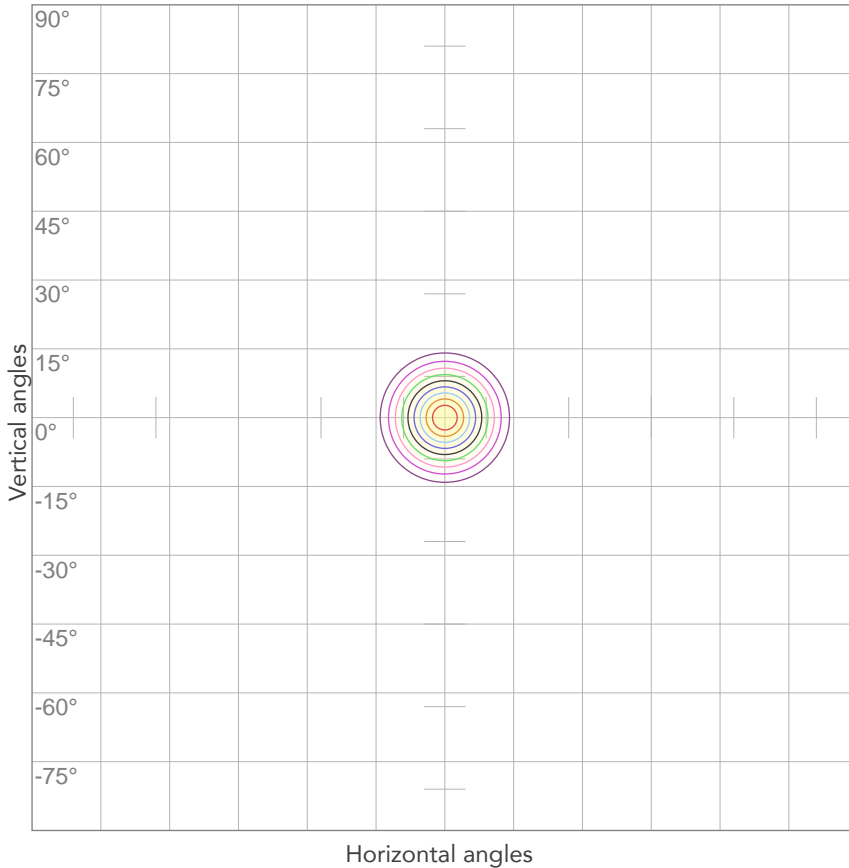

10%	192 cd
20%	383 cd
30%	575 cd
40%	767 cd
50%	959 cd
60%	1150 cd
70%	{LUX_1M70} cd
80%	1534 cd

Conditions:  
 Number of c-planes: 2  
 Candela at center: 1917 cd

## ISO LUX DIAGRAM

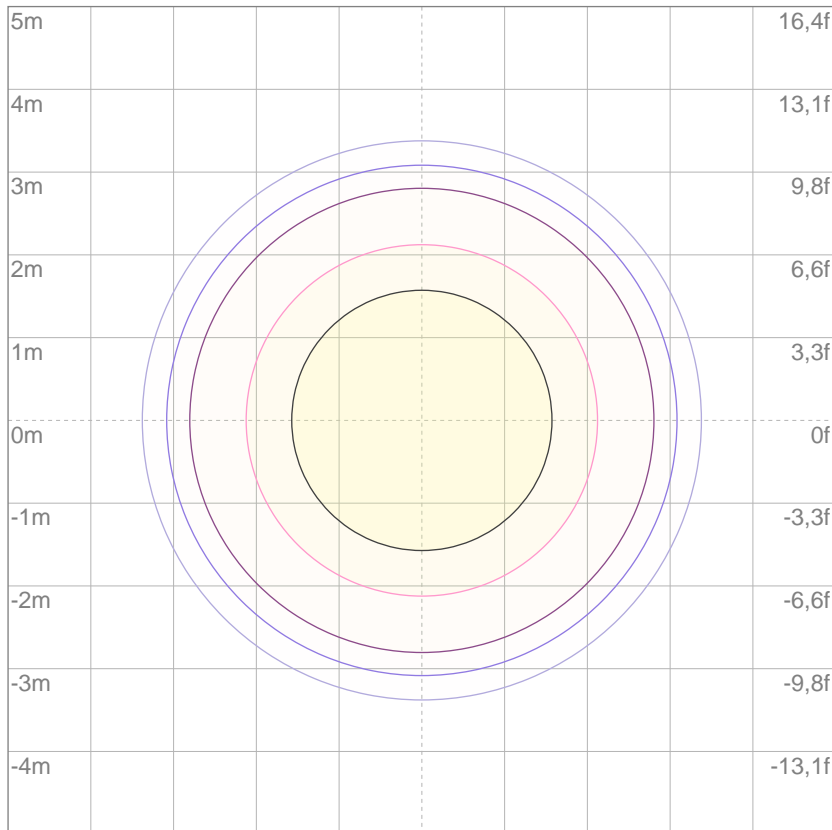

3%	0,575 lx
5%	0,959 lx
10%	1,92 lx
30%	5,75 lx
50%	9,59 lx

Conditions:  
 Number of c-planes: 2  
 Lux at center: 19,2 lx

*Lux distribution on a surface when lamp is mounted at 10 meters from the surface.*

Mounting height: 10 meters (33 feet)





Total lumen output:

535 lm

Total candela output:

572 cd

**PRODUCT NAME:**

EclipseFresnel TW

**MEASUREMENT CONDITIONS:**

Beam angle:

45°

Target:

Royal blue

Operator:

Marco Marrocco

Date and time:

14/12/2019 10:34:13

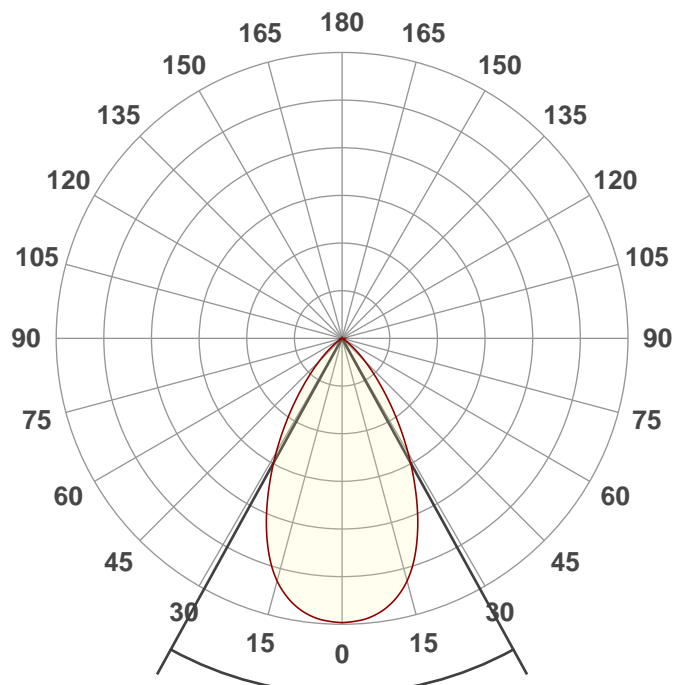

Beam angle

**57,7°**

Spectra

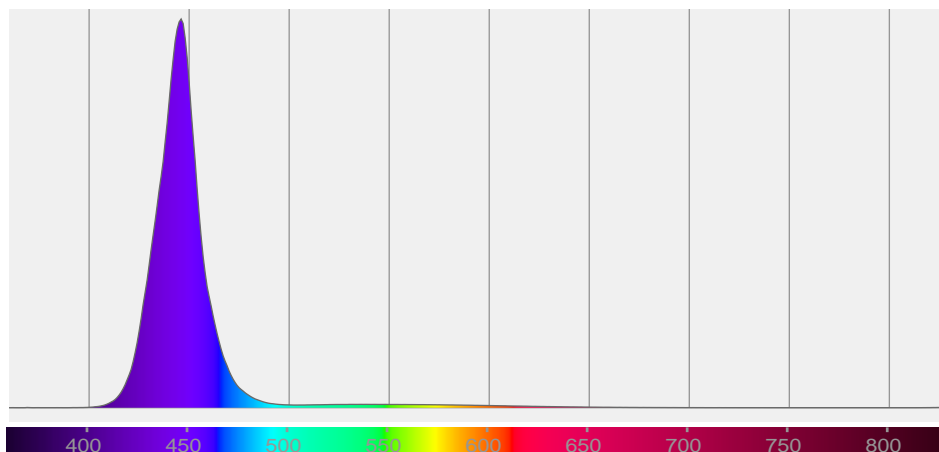

# BEAM DETAILS



Beam angle 50%	Field angle 10%	Cutoff angle 2,5%	Intensity ratio in 120° cone	Intensity ratio in 90° cone
57,7°	92,1°	108°	99,6%	93,9%

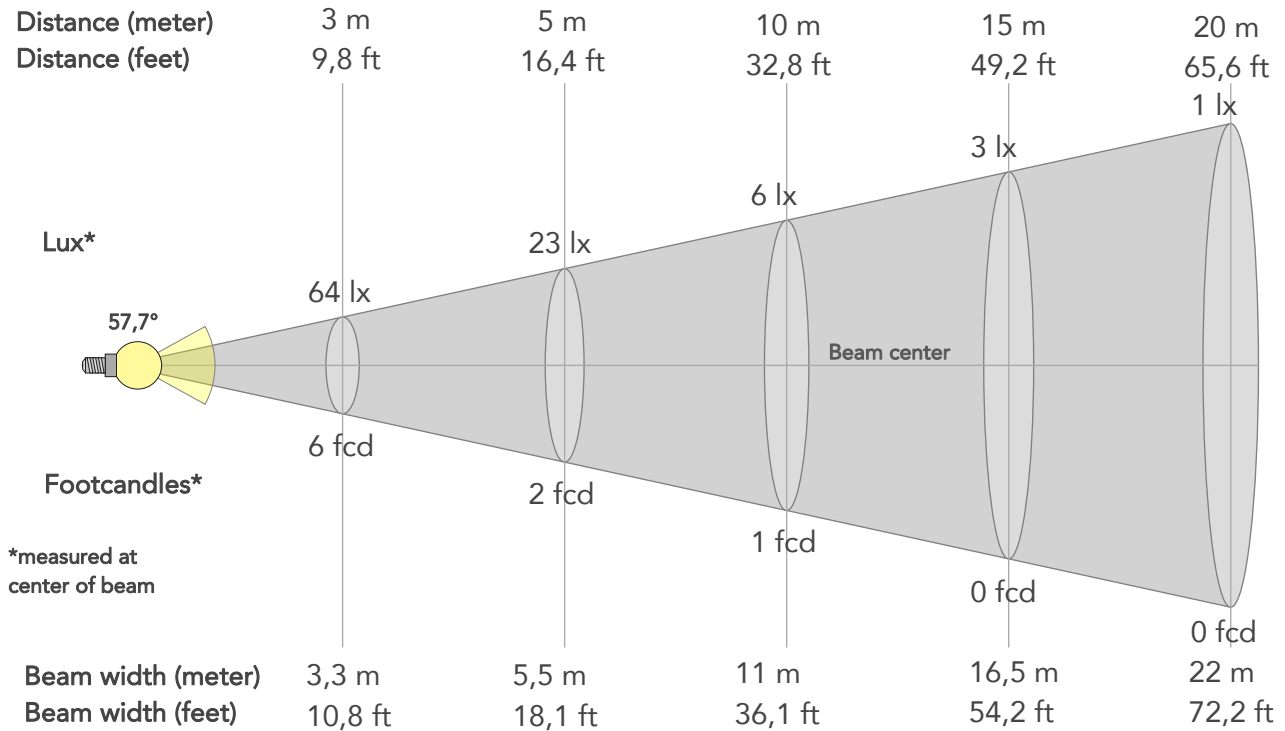

## BEAM INTENSITIES AND WIDTHS

Distance	1m	2m	3m	4m	5m	7,5m	10m	15m	20m	25m	30m	40m	50m
Distance	3,3ft	6,6ft	9,8ft	13,1ft	16,4ft	24,6ft	32,8ft	49,2ft	65,6ft	82ft	98,4ft	131,2ft	164ft
Lux	572lx	143lx	64lx	36lx	23lx	10lx	6lx	3lx	1lx	1lx	1lx	0lx	0lx
Footcand.	53fcd	13fcd	6fcd	3fcd	2fcd	1fcd	1fcd	0fcd	0fcd	0fcd	0fcd	0fcd	0fcd
Beam wid.	1,1m	2,2m	3,3m	4,4m	5,5m	8,3m	11m	16,5m	22m	27,5m	33m	44m	55,1m
Beam wid.	3,6ft	7,3ft	10,8ft	14,4ft	18,1ft	27,1ft	36,1ft	54,2ft	72,2ft	90,3ft	108,3ft	144,5ft	180,6ft

## LINEAR DISTRIBUTION DIAGRAM

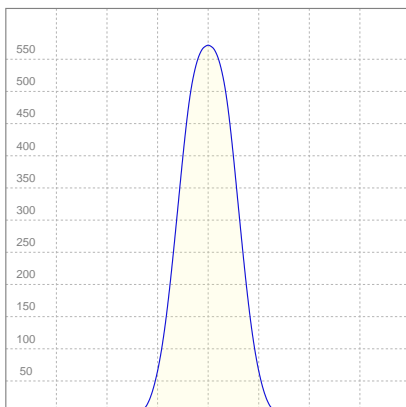

## ELECTRICAL SPECIFICATIONS

Input voltage	Input current	Input power	Effeciency
227V	0,348A	59,6W	9lm/W

## ISO CANDELA DIAGRAM

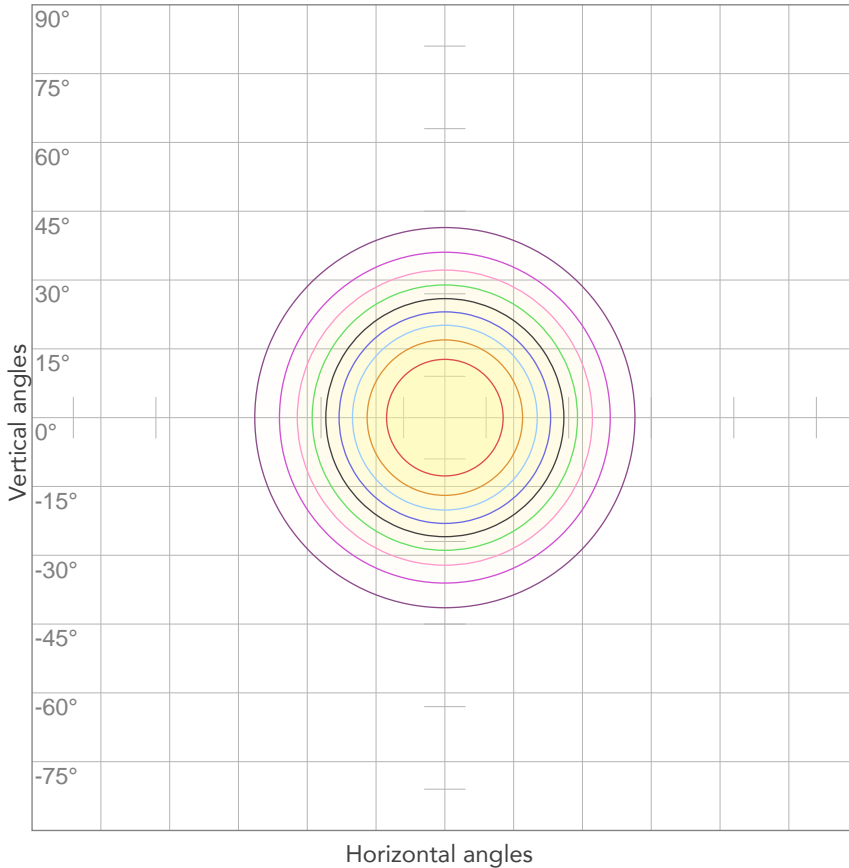

10%	57 cd
20%	114 cd
30%	172 cd
40%	229 cd
50%	286 cd
60%	343 cd
70%	{LUX_1M70} cd
80%	457 cd

**Conditions:**

Number of c-planes: 2  
Candela at center: 572 cd

## ISO LUX DIAGRAM

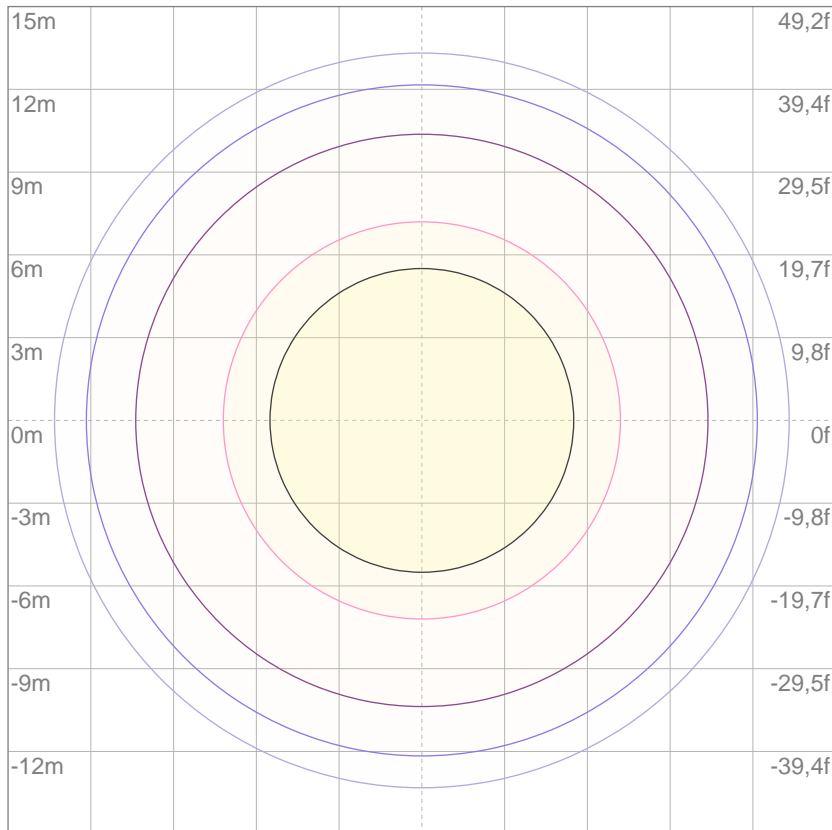

3%	0,172 lx
5%	0,286 lx
10%	0,572 lx
30%	1,72 lx
50%	2,86 lx

**Conditions:**

Number of c-planes: 2  
Lux at center: 5,72 lx

*Lux distribution on a surface when lamp is mounted at 10 meters from the surface.*

Mounting height: 10 meters (33 feet)



Total lumen output:

485 lm

Total candela output:

1578 cd

**PRODUCT NAME:**

EclipseFresnel TW

**MEASUREMENT CONDITIONS:**

Beam angle:

30°

Target:

Royal blue

Operator:

Marco Marrocco

Date and time:

14/12/2019 12:10:49

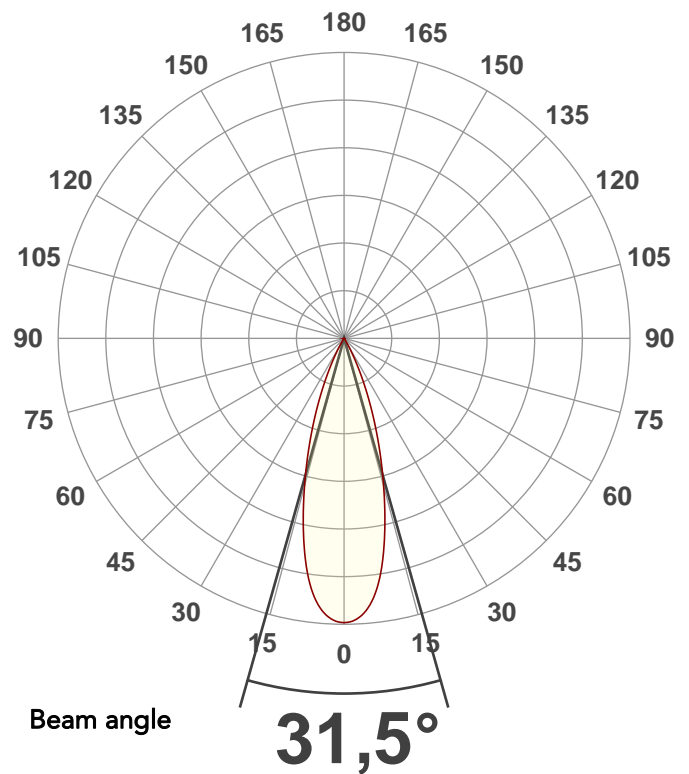

Spectra

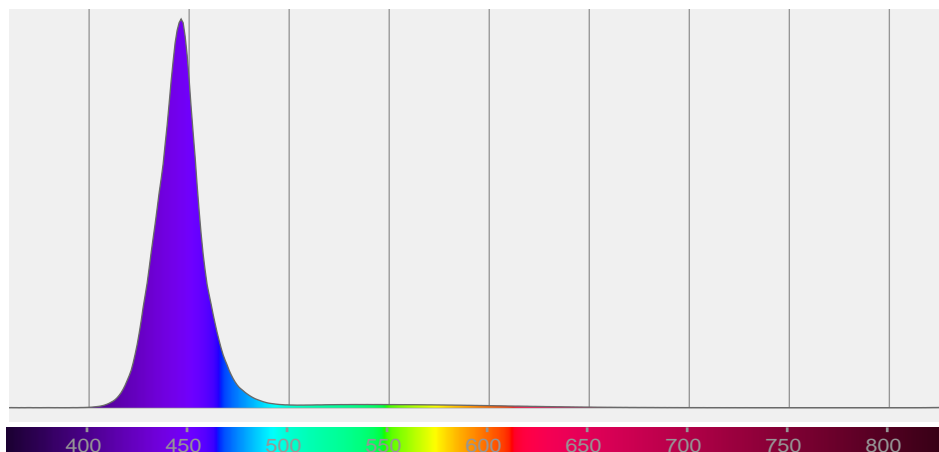

# BEAM DETAILS



Beam angle 50%	Field angle 10%	Cutoff angle 2,5%	Intensity ratio in 120° cone	Intensity ratio in 90° cone
31,5°	52,6°	61,4°	99,5%	98,7%

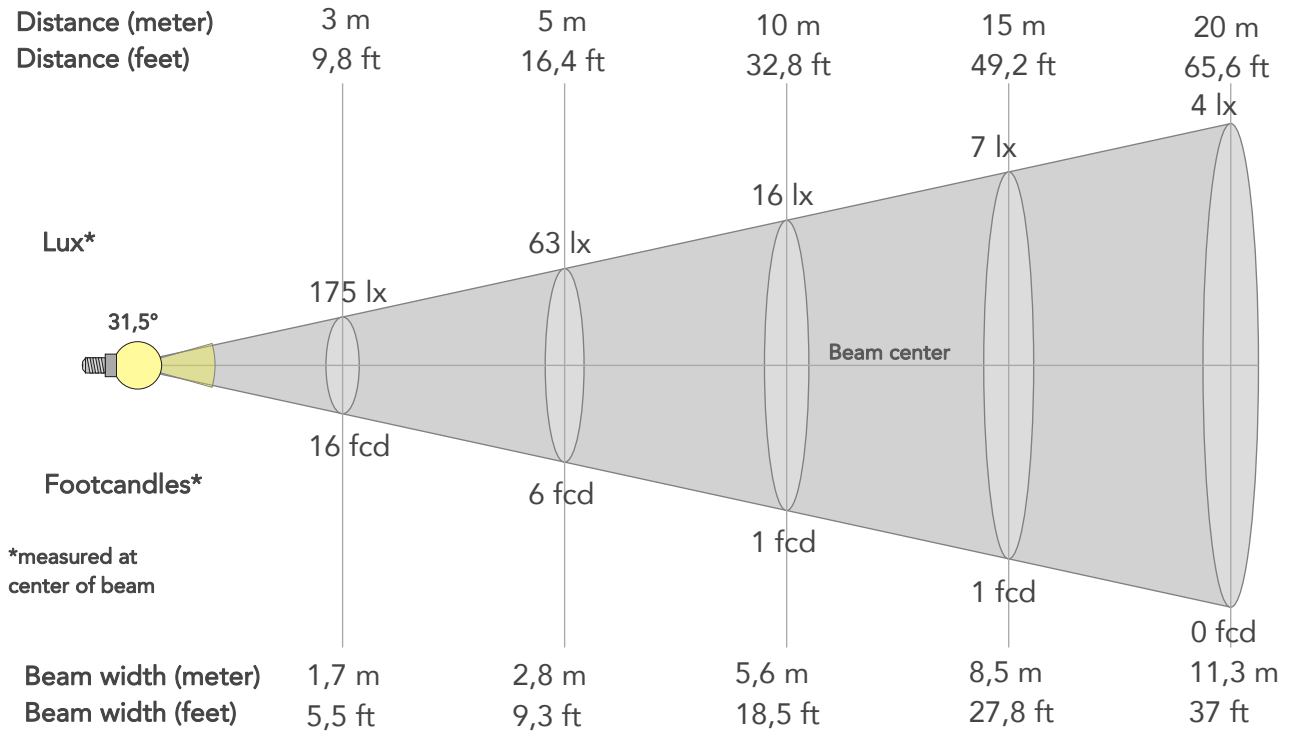

## BEAM INTENSITIES AND WIDTHS

Distance	1m	2m	3m	4m	5m	7,5m	10m	15m	20m	25m	30m	40m	50m
Distance	3,3ft	6,6ft	9,8ft	13,1ft	16,4ft	24,6ft	32,8ft	49,2ft	65,6ft	82ft	98,4ft	131,2ft	164ft
Lux	1578lx	394lx	175lx	99lx	63lx	28lx	16lx	7lx	4lx	3lx	2lx	1lx	1lx
Footcand.	147fcd	37fcd	16fcd	9fcd	6fcd	3fcd	1fcd	1fcd	0fcd	0fcd	0fcd	0fcd	0fcd
Beam wid.	0,6m	1,1m	1,7m	2,3m	2,8m	4,2m	5,6m	8,5m	11,3m	14,1m	16,9m	22,6m	28,2m
Beam wid.	1,9ft	3,7ft	5,5ft	7,4ft	9,3ft	13,9ft	18,5ft	27,8ft	37ft	46,3ft	55,6ft	74,1ft	92,6ft

## LINEAR DISTRIBUTION DIAGRAM

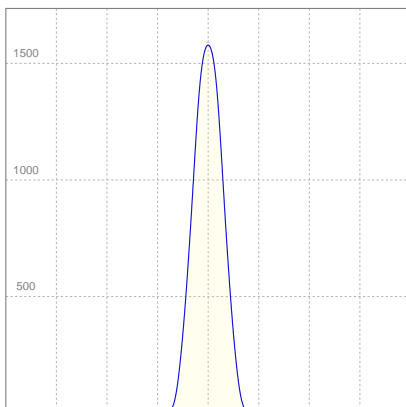

## ELECTRICAL SPECIFICATIONS

Input voltage	Input current	Input power	Effeciency
227V	0,349A	59,7W	8lm/W

## ISO CANDELA DIAGRAM

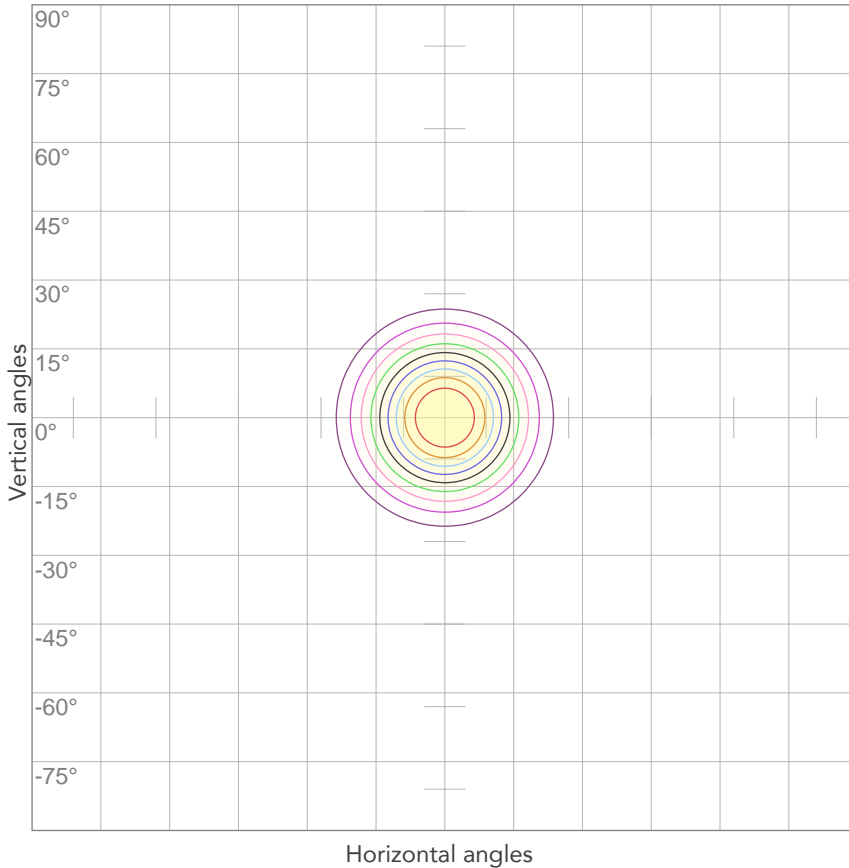

10%	158 cd
20%	316 cd
30%	473 cd
40%	631 cd
50%	789 cd
60%	947 cd
70%	{LUX_1M70} cd
80%	1262 cd

Conditions:  
 Number of c-planes: 2  
 Candela at center: 1578 cd

## ISO LUX DIAGRAM

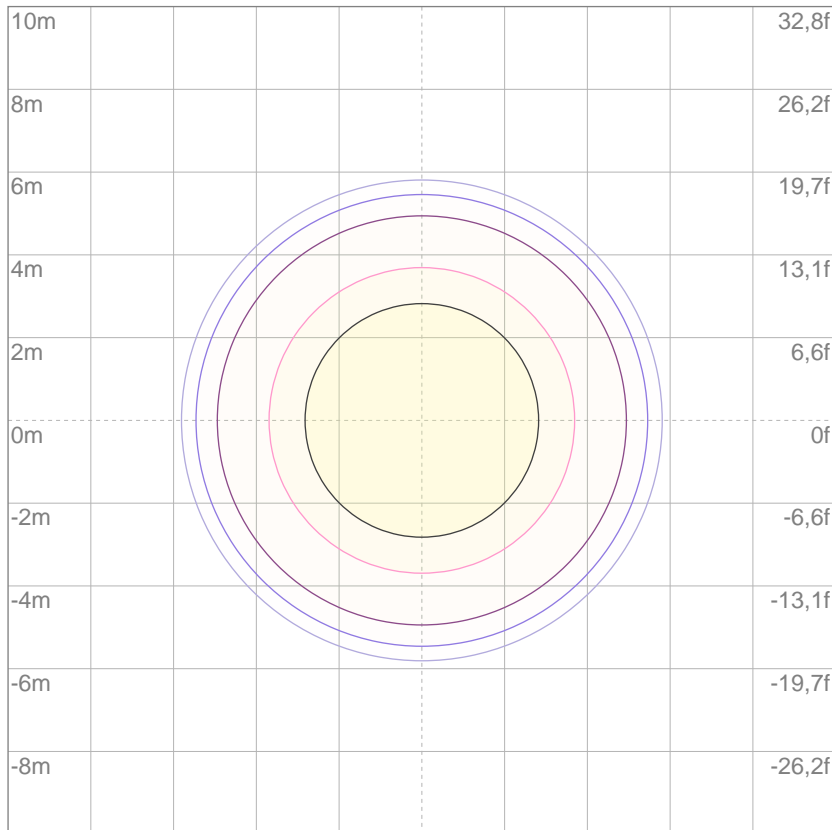

3%	0,473 lx
5%	0,789 lx
10%	1,58 lx
30%	4,73 lx
50%	7,89 lx

Conditions:  
 Number of c-planes: 2  
 Lux at center: 15,8 lx

*Lux distribution on a surface when lamp is mounted at 10 meters from the surface.*

Mounting height: 10 meters (33 feet)



Total lumen output:

298 lm

Total candela output:

2673 cd

**PRODUCT NAME:**

EclipseFresnel TW

**MEASUREMENT CONDITIONS:**

Beam angle:

15°

Target:

Royal blue

Operator:

Marco Marrocco

Date and time:

14/12/2019 11:38:15

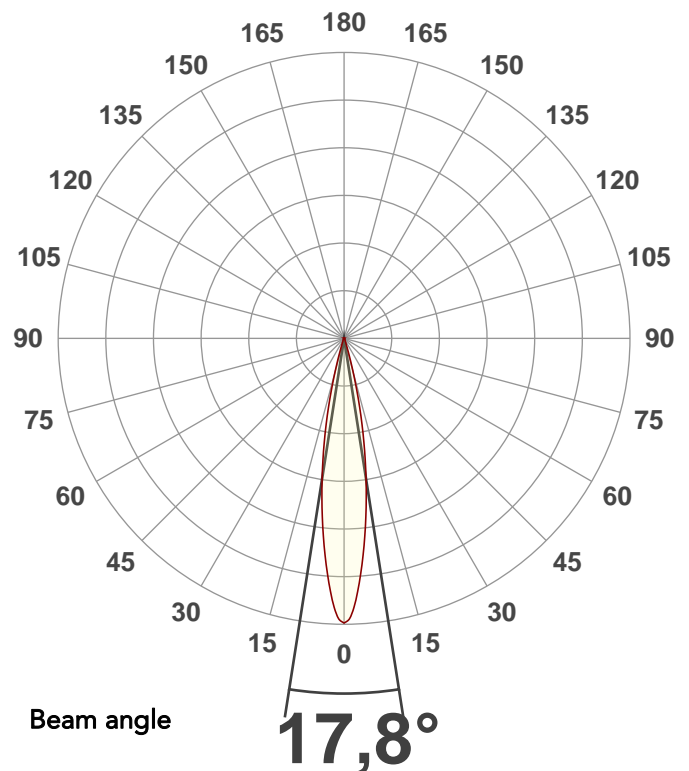

Spectra

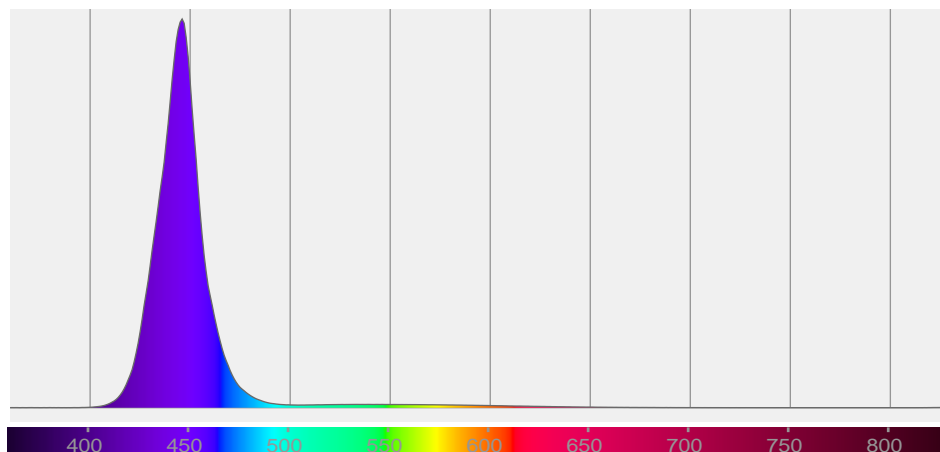

# BEAM DETAILS



Beam angle 50%	Field angle 10%	Cutoff angle 2,5%	Intensity ratio in 120° cone	Intensity ratio in 90° cone
17,8°	31,2°	38,7°	99,3%	98,1%

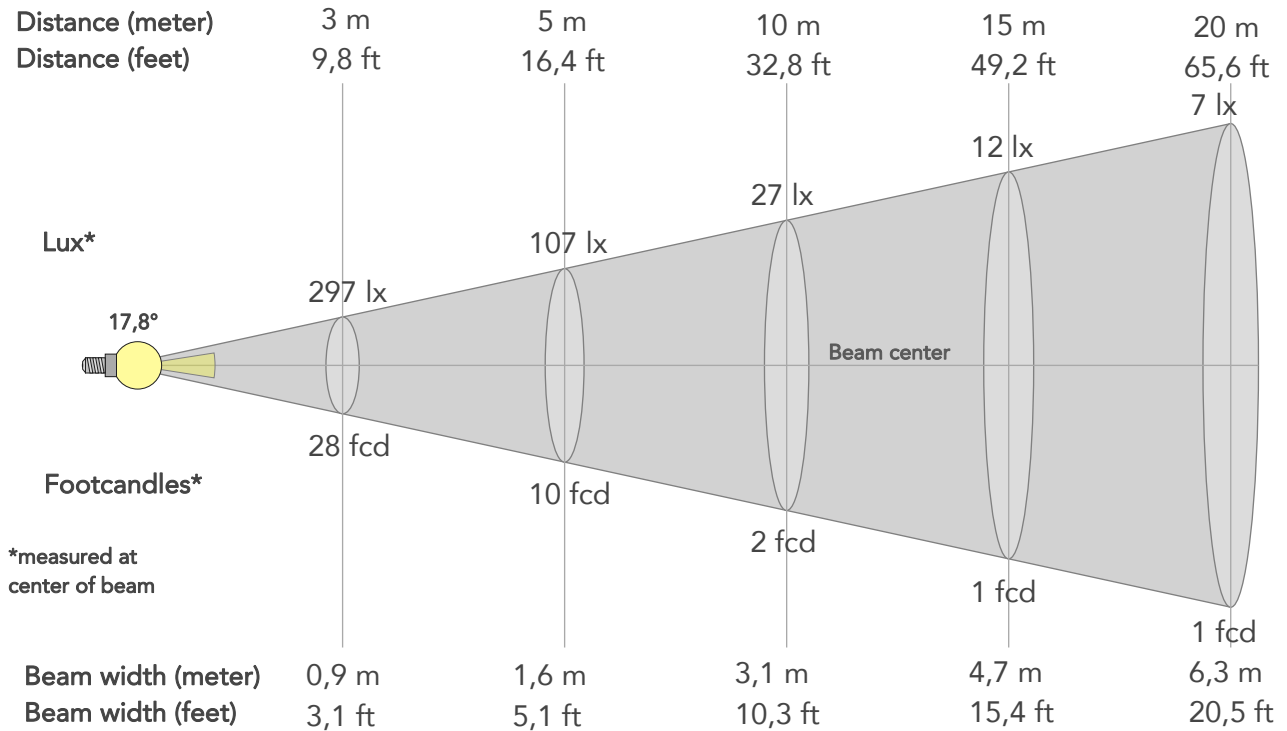

## BEAM INTENSITIES AND WIDTHS

Distance	1m	2m	3m	4m	5m	7,5m	10m	15m	20m	25m	30m	40m	50m
Distance	3,3ft	6,6ft	9,8ft	13,1ft	16,4ft	24,6ft	32,8ft	49,2ft	65,6ft	82ft	98,4ft	131,2ft	164ft
Lux	2673lx	668lx	297lx	167lx	107lx	48lx	27lx	12lx	7lx	4lx	3lx	2lx	1lx
Footcand.	248fcd	62fcd	28fcd	16fcd	10fcd	4fcd	2fcd	1fcd	1fcd	0fcd	0fcd	0fcd	0fcd
Beam wid.	0,3m	0,6m	0,9m	1,3m	1,6m	2,3m	3,1m	4,7m	6,3m	7,8m	9,4m	12,5m	15,6m
Beam wid.	1ft	2,1ft	3,1ft	4,1ft	5,1ft	7,7ft	10,3ft	15,4ft	20,5ft	25,6ft	30,8ft	41ft	51,3ft

## LINEAR DISTRIBUTION DIAGRAM

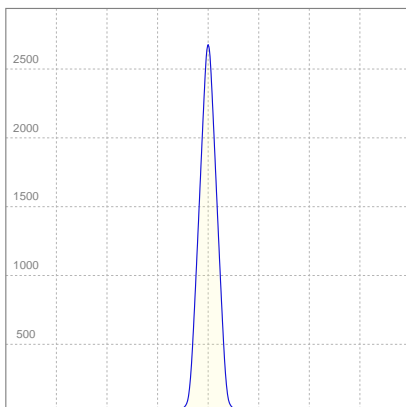

## ELECTRICAL SPECIFICATIONS

Input voltage	Input current	Input power	Effeciency
229V	0,349A	59,8W	5lm/W



## ISO CANDELA DIAGRAM

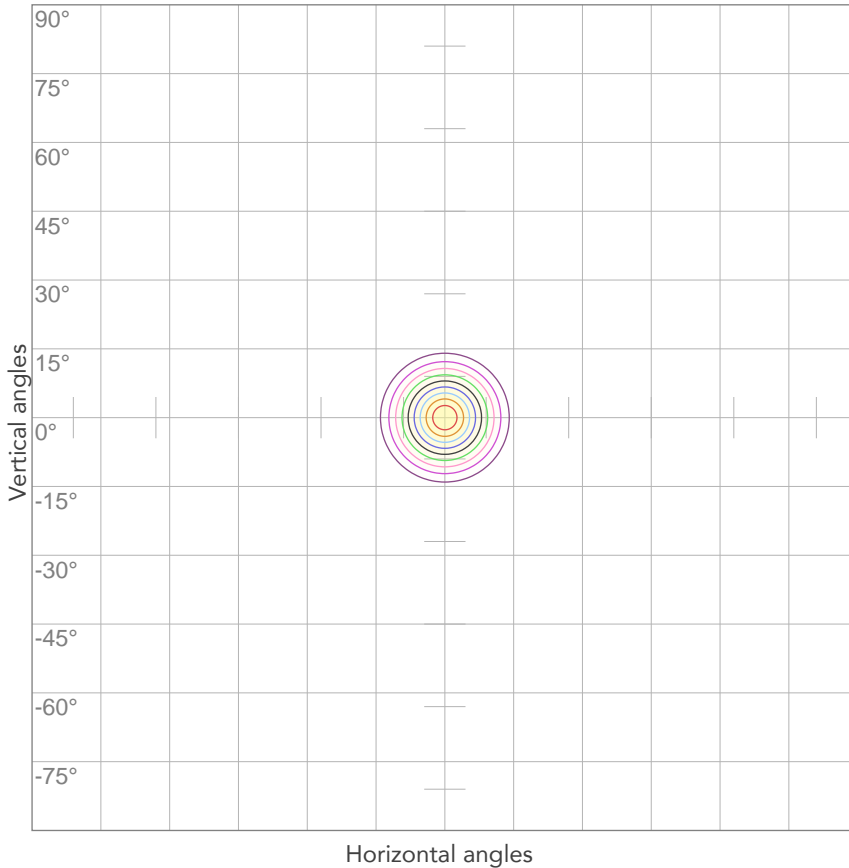

10%	267 cd
20%	535 cd
30%	802 cd
40%	1069 cd
50%	1336 cd
60%	1604 cd
70%	{LUX_1M70} cd
80%	2138 cd

Conditions:  
 Number of c-planes: 2  
 Candela at center: 2673 cd

## ISO LUX DIAGRAM

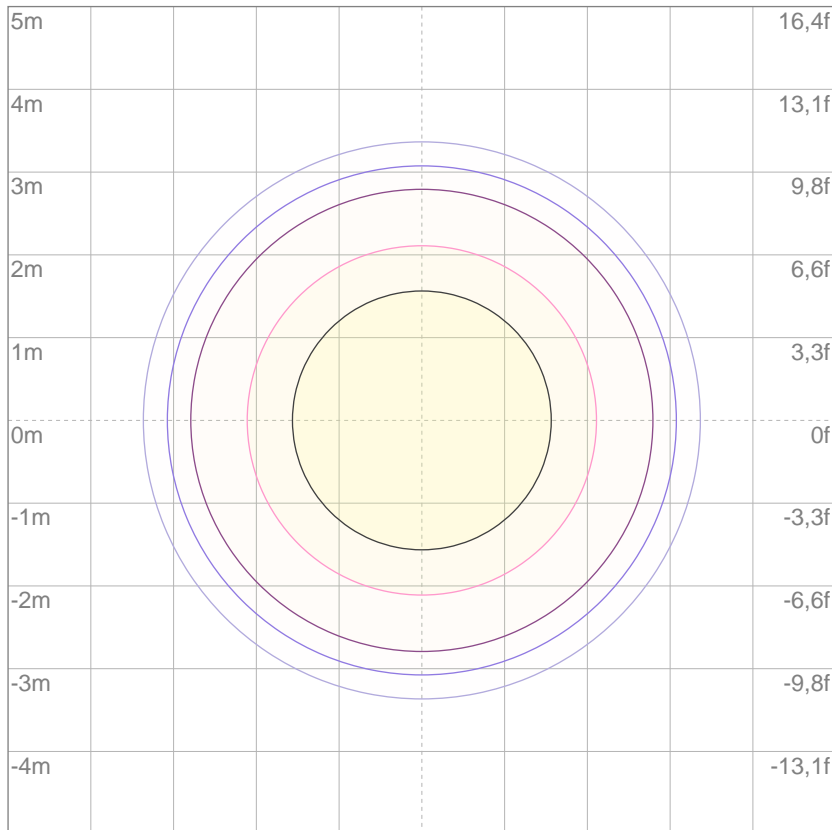

3%	0,802 lx
5%	1,34 lx
10%	2,67 lx
30%	8,02 lx
50%	13,4 lx

Conditions:  
 Number of c-planes: 2  
 Lux at center: 26,7 lx

*Lux distribution on a surface when lamp is mounted at 10 meters from the surface.*

Mounting height: 10 meters (33 feet)



Total lumen output:

485 lm

Total candela output:

497 cd

**PRODUCT NAME:**

EclipseFresnel TW

**MEASUREMENT CONDITIONS:**

Beam angle:

45°

Target:

Blue

Operator:

Marco Marrocco

Date and time:

14/12/2019 10:37:14

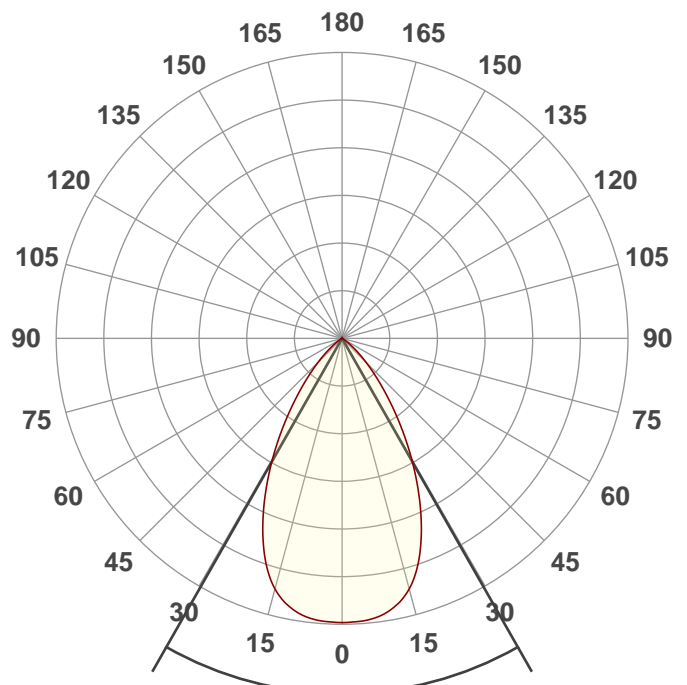

Beam angle

**59,3°**

Spectra

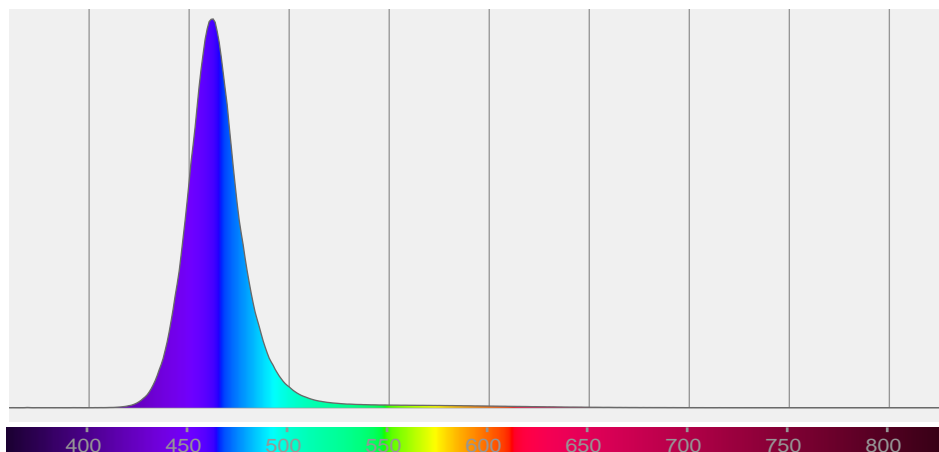

# BEAM DETAILS



Beam angle 50%	Field angle 10%	Cutoff angle 2,5%	Intensity ratio in 120° cone	Intensity ratio in 90° cone
59,3°	92,8°	108,6°	99,5%	93,7%

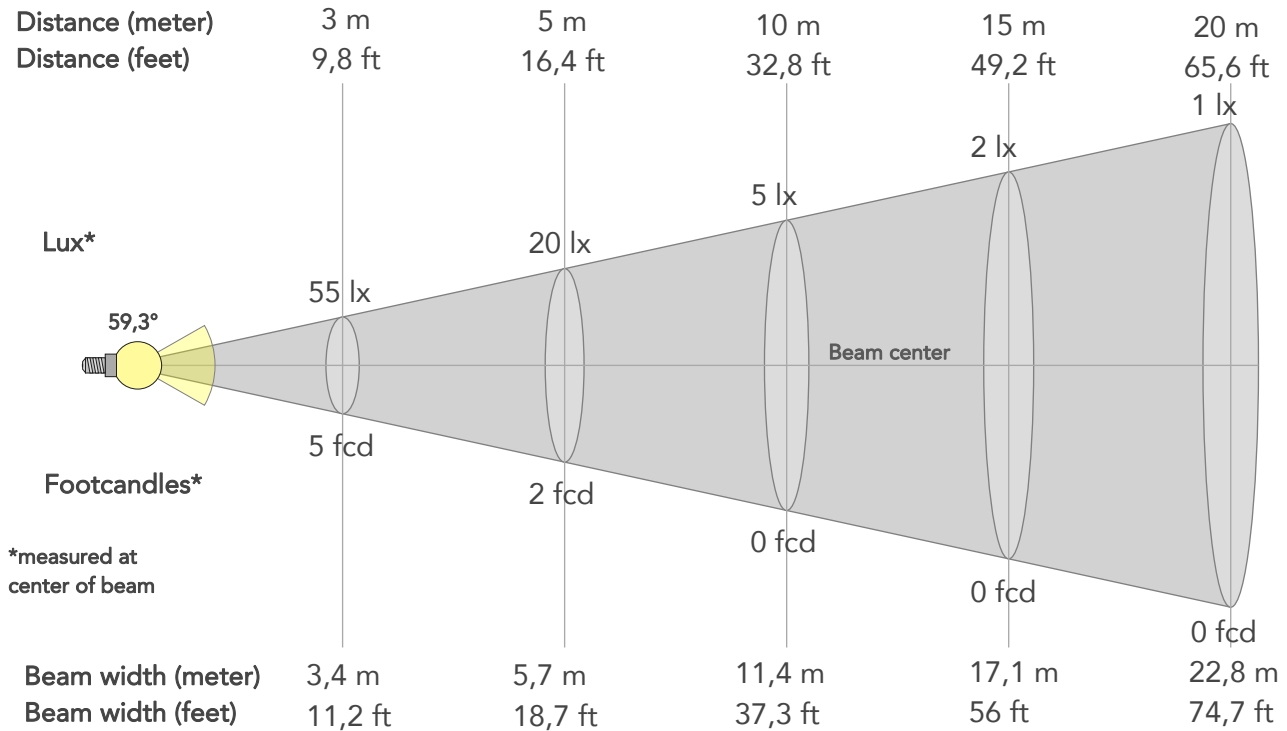

## BEAM INTENSITIES AND WIDTHS

Distance	1m	2m	3m	4m	5m	7,5m	10m	15m	20m	25m	30m	40m	50m
Distance	3,3ft	6,6ft	9,8ft	13,1ft	16,4ft	24,6ft	32,8ft	49,2ft	65,6ft	82ft	98,4ft	131,2ft	164ft
Lux	497lx	124lx	55lx	31lx	20lx	9lx	5lx	2lx	1lx	1lx	1lx	0lx	0lx
Footcand.	46fcd	12fcd	5fcd	3fcd	2fcd	1fcd	0fcd	0fcd	0fcd	0fcd	0fcd	0fcd	0fcd
Beam wid.	1,1m	2,3m	3,4m	4,6m	5,7m	8,5m	11,4m	17,1m	22,8m	28,5m	34,2m	45,5m	56,9m
Beam wid.	3,8ft	7,5ft	11,2ft	14,9ft	18,7ft	28ft	37,3ft	56ft	74,7ft	93,4ft	112ft	149,4ft	186,7ft

## LINEAR DISTRIBUTION DIAGRAM

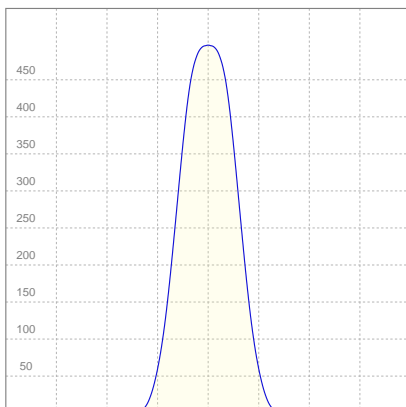

## ELECTRICAL SPECIFICATIONS

Input voltage	Input current	Input power	Effeciency
228V	0,315A	50,9W	10lm/W

## ISO CANDELA DIAGRAM

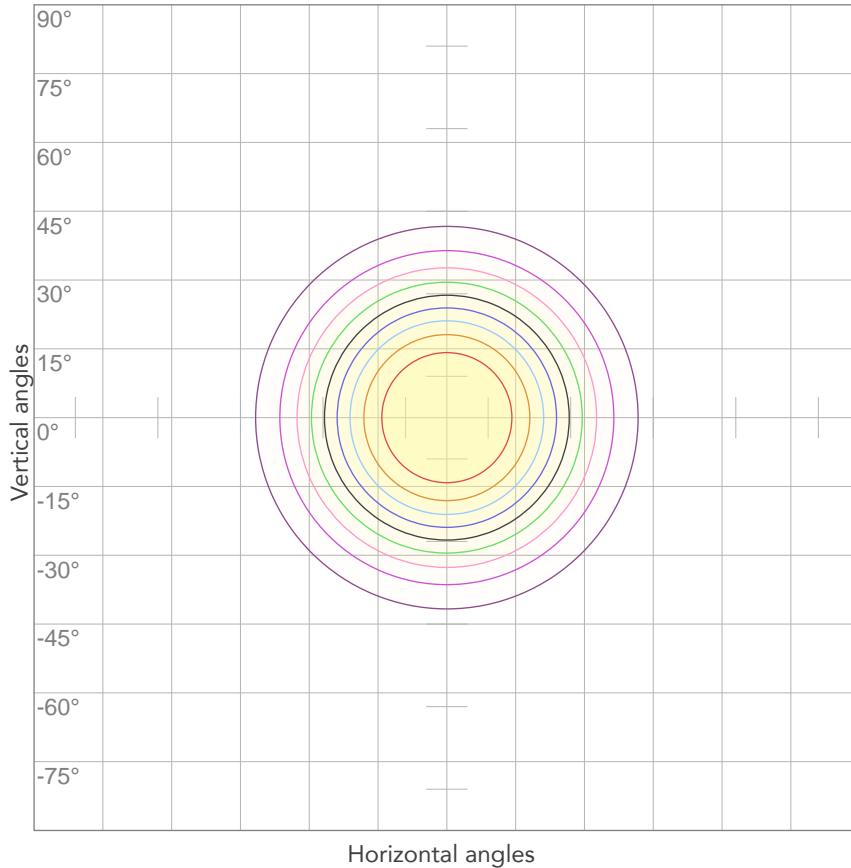

10%	50 cd
20%	99 cd
30%	149 cd
40%	199 cd
50%	248 cd
60%	298 cd
70%	{LUX_1M70} cd
80%	397 cd

**Conditions:**

Number of c-planes: 2

Candela at center: 497 cd

## ISO LUX DIAGRAM

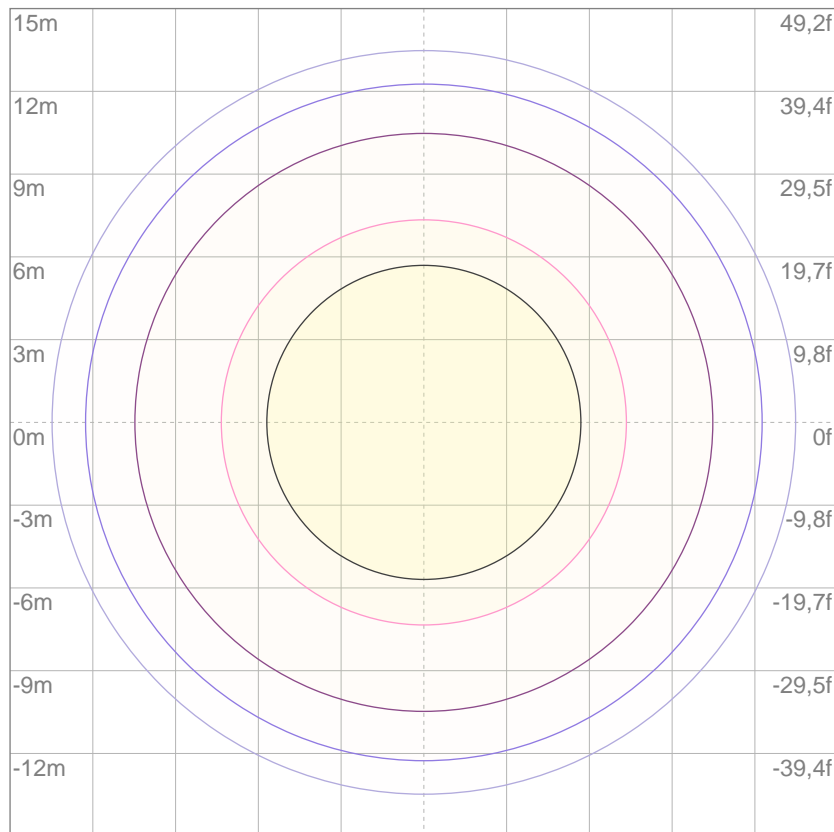

3%	0,149 lx
5%	0,248 lx
10%	0,497 lx
30%	1,49 lx
50%	2,48 lx

**Conditions:**

Number of c-planes: 2

Lux at center: 4,97 lx

*Lux distribution on a surface when lamp is mounted at 10 meters from the surface.*

Mounting height: 10 meters (33 feet)



Total lumen output:

442 lm

Total candela output:

1393 cd

**PRODUCT NAME:**

EclipseFresnel TW

**MEASUREMENT CONDITIONS:**

Beam angle:

30°

Target:

Blue

Operator:

Marco Marrocco

Date and time:

14/12/2019 12:13:08

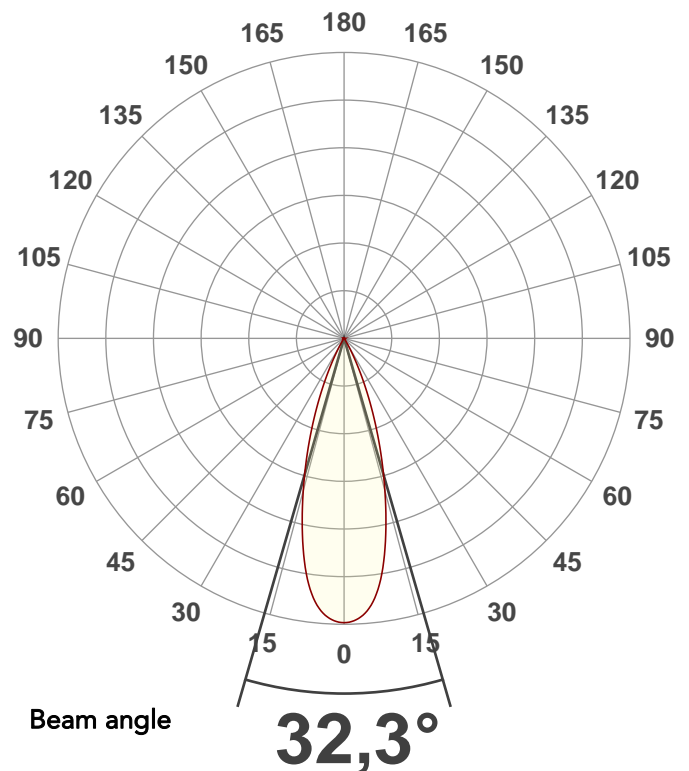

Spectra

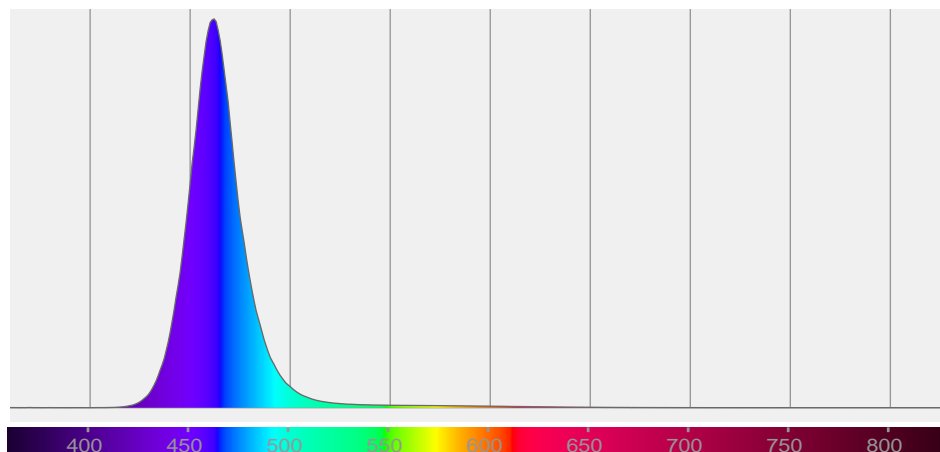

# BEAM DETAILS



Beam angle 50%	Field angle 10%	Cutoff angle 2,5%	Intensity ratio in 120° cone	Intensity ratio in 90° cone
32,3°	53°	61,6°	99,5%	98,5%

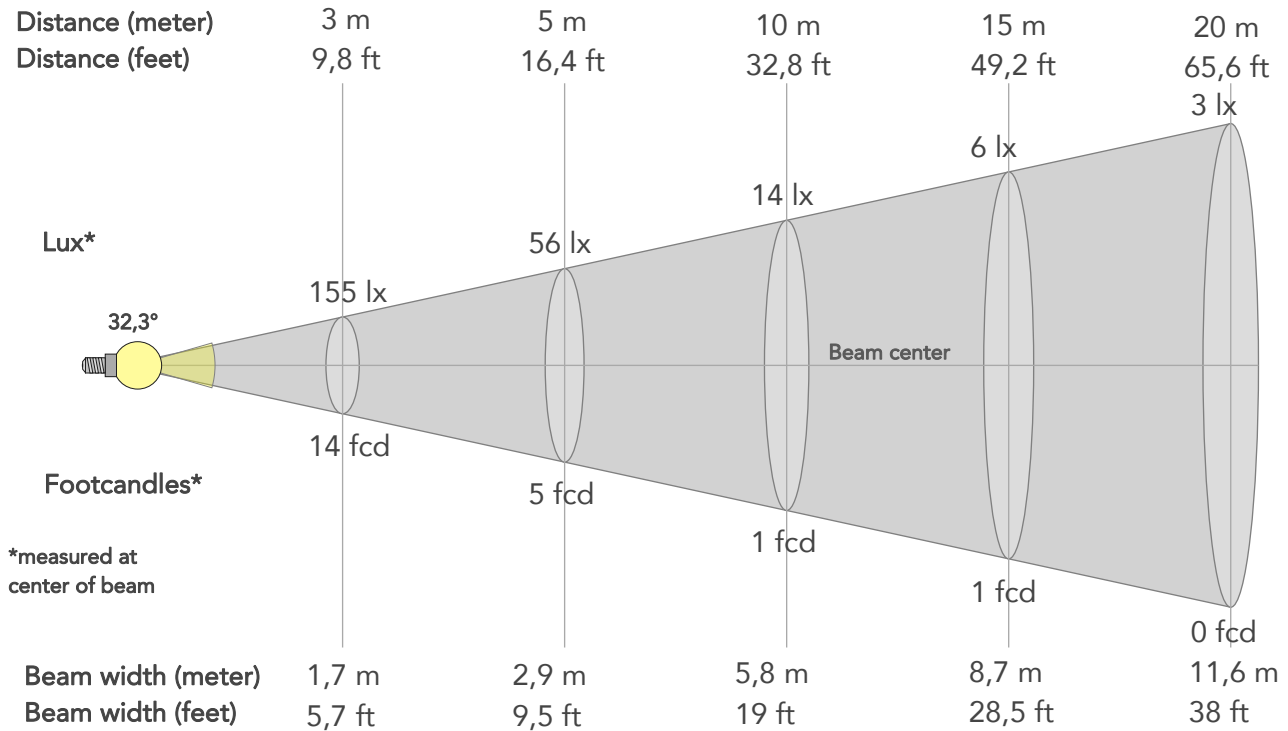

## BEAM INTENSITIES AND WIDTHS

Distance	1m	2m	3m	4m	5m	7,5m	10m	15m	20m	25m	30m	40m	50m
Distance	3,3ft	6,6ft	9,8ft	13,1ft	16,4ft	24,6ft	32,8ft	49,2ft	65,6ft	82ft	98,4ft	131,2ft	164ft
Lux	1393lx	348lx	155lx	87lx	56lx	25lx	14lx	6lx	3lx	2lx	2lx	1lx	1lx
Footcand.	129fcd	32fcd	14fcd	8fcd	5fcd	2fcd	1fcd	1fcd	0fcd	0fcd	0fcd	0fcd	0fcd
Beam wid.	0,6m	1,2m	1,7m	2,3m	2,9m	4,3m	5,8m	8,7m	11,6m	14,5m	17,4m	23,1m	28,9m
Beam wid.	1,9ft	3,8ft	5,7ft	7,6ft	9,5ft	14,2ft	19ft	28,5ft	38ft	47,4ft	56,9ft	75,9ft	94,9ft

## LINEAR DISTRIBUTION DIAGRAM

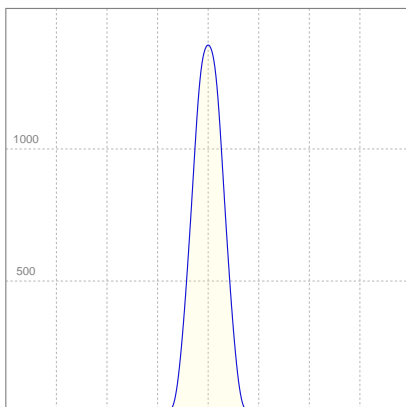

## ELECTRICAL SPECIFICATIONS

Input voltage	Input current	Input power	Effeciency
227V	0,315A	50,9W	9lm/W

## ISO CANDELA DIAGRAM

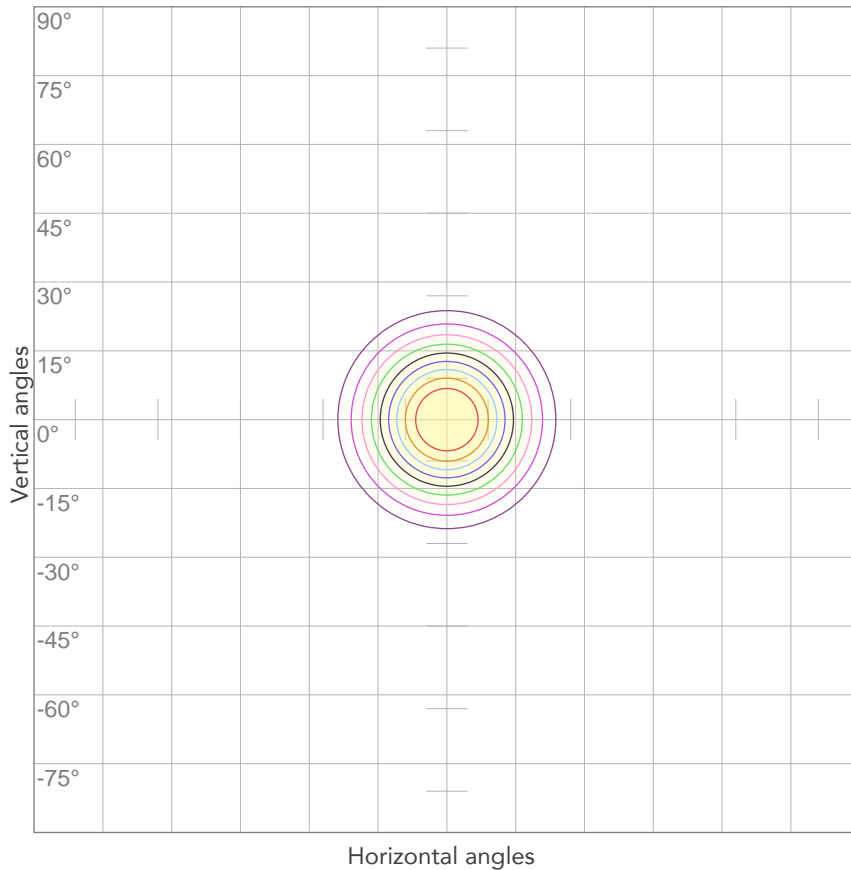

10%	139 cd
20%	279 cd
30%	418 cd
40%	557 cd
50%	696 cd
60%	836 cd
70%	{LUX_1M70} cd
80%	1114 cd

Conditions:  
 Number of c-planes: 2  
 Candela at center: 1393 cd

## ISO LUX DIAGRAM

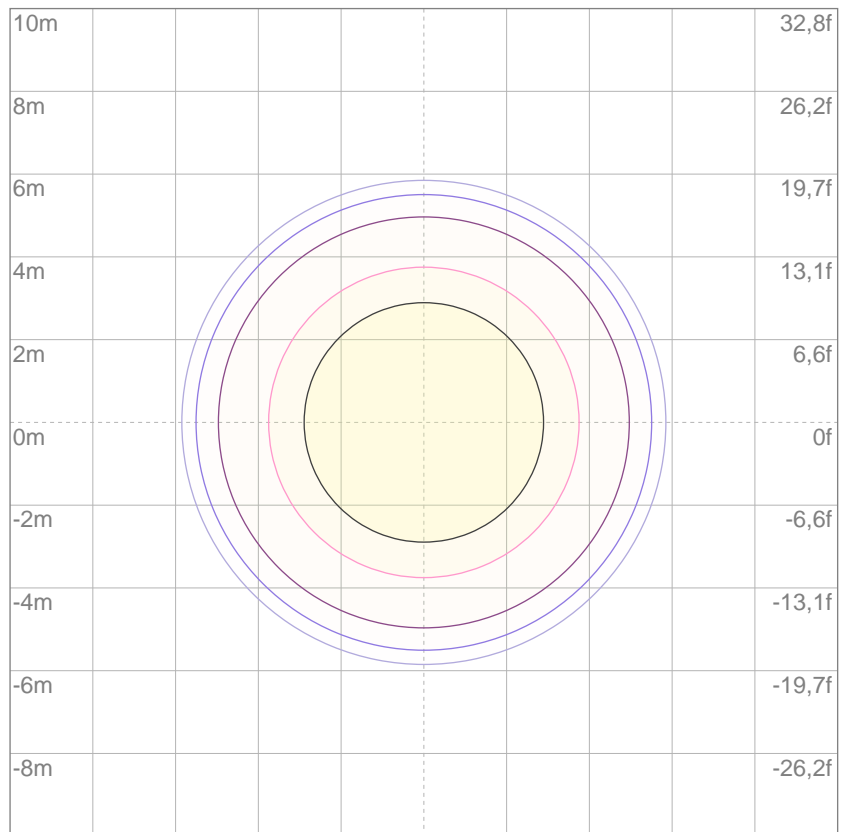

3%	0,418 lx
5%	0,696 lx
10%	1,39 lx
30%	4,18 lx
50%	6,96 lx

Conditions:  
 Number of c-planes: 2  
 Lux at center: 13,9 lx

*Lux distribution on a surface when lamp is mounted at 10 meters from the surface.*

Mounting height: 10 meters (33 feet)



Total lumen output:

274 lm

Total candela output:

2386 cd

**PRODUCT NAME:**

EclipseFresnel TW

**MEASUREMENT CONDITIONS:**

Beam angle:

15°

Target:

Blue

Operator:

Marco Marrocco

Date and time:

14/12/2019 11:41:04

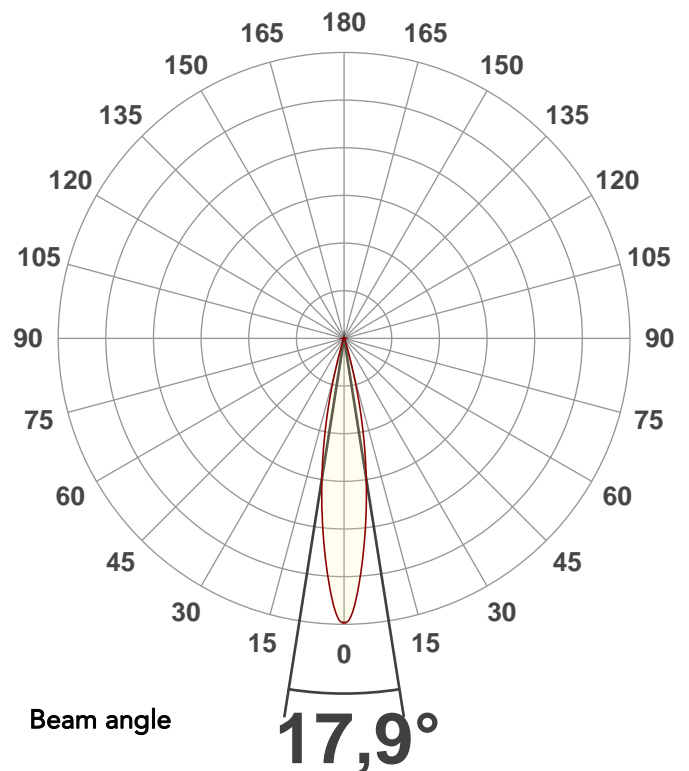

Spectra

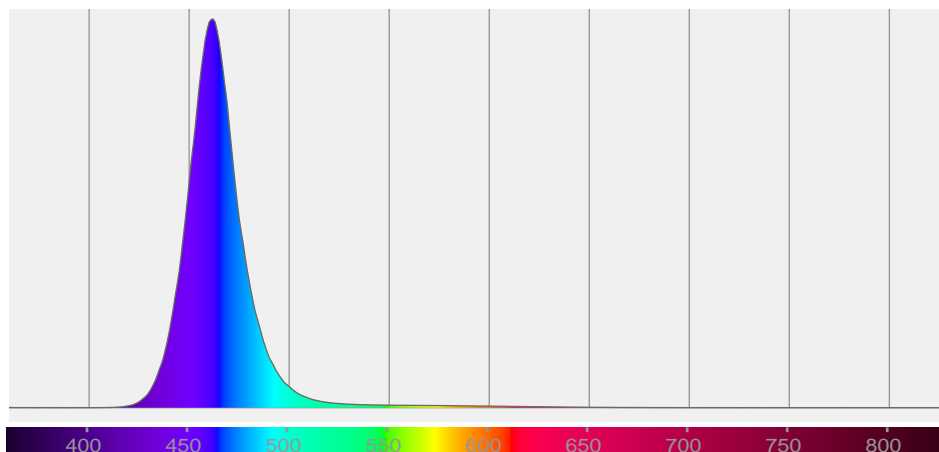



# BEAM DETAILS



Beam angle 50%	Field angle 10%	Cutoff angle 2,5%	Intensity ratio in 120° cone	Intensity ratio in 90° cone
17,9°	31,4°	39°	99,2%	97,8%

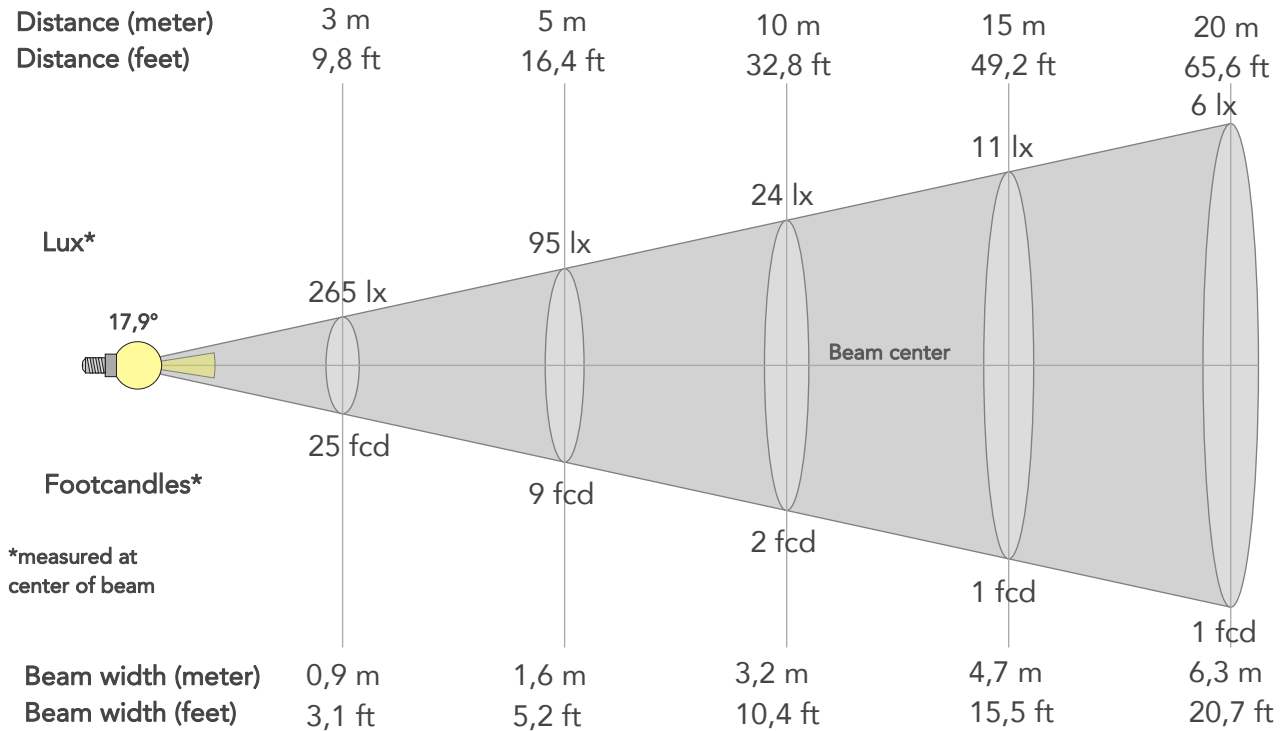

## BEAM INTENSITIES AND WIDTHS

Distance	1m	2m	3m	4m	5m	7,5m	10m	15m	20m	25m	30m	40m	50m
Distance	3,3ft	6,6ft	9,8ft	13,1ft	16,4ft	24,6ft	32,8ft	49,2ft	65,6ft	82ft	98,4ft	131,2ft	164ft
Lux	2386lx	596lx	265lx	149lx	95lx	42lx	24lx	11lx	6lx	4lx	3lx	1lx	1lx
Footcand.	222fcd	55fcd	25fcd	14fcd	9fcd	4fcd	2fcd	1fcd	1fcd	0fcd	0fcd	0fcd	0fcd
Beam wid.	0,3m	0,6m	0,9m	1,3m	1,6m	2,4m	3,2m	4,7m	6,3m	7,9m	9,5m	12,6m	15,8m
Beam wid.	1ft	2,1ft	3,1ft	4,1ft	5,2ft	7,8ft	10,4ft	15,5ft	20,7ft	25,9ft	31,1ft	41,4ft	51,8ft

## LINEAR DISTRIBUTION DIAGRAM

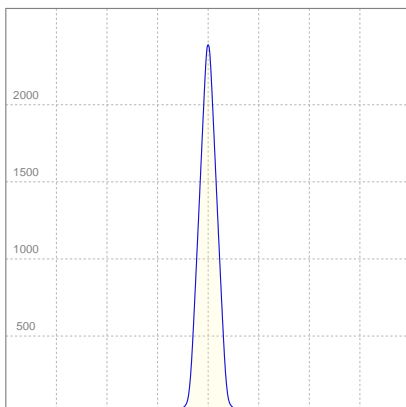

## ELECTRICAL SPECIFICATIONS

Input voltage	Input current	Input power	Effeciency
228V	0,316A	51,0W	5lm/W

## ISO CANDELA DIAGRAM

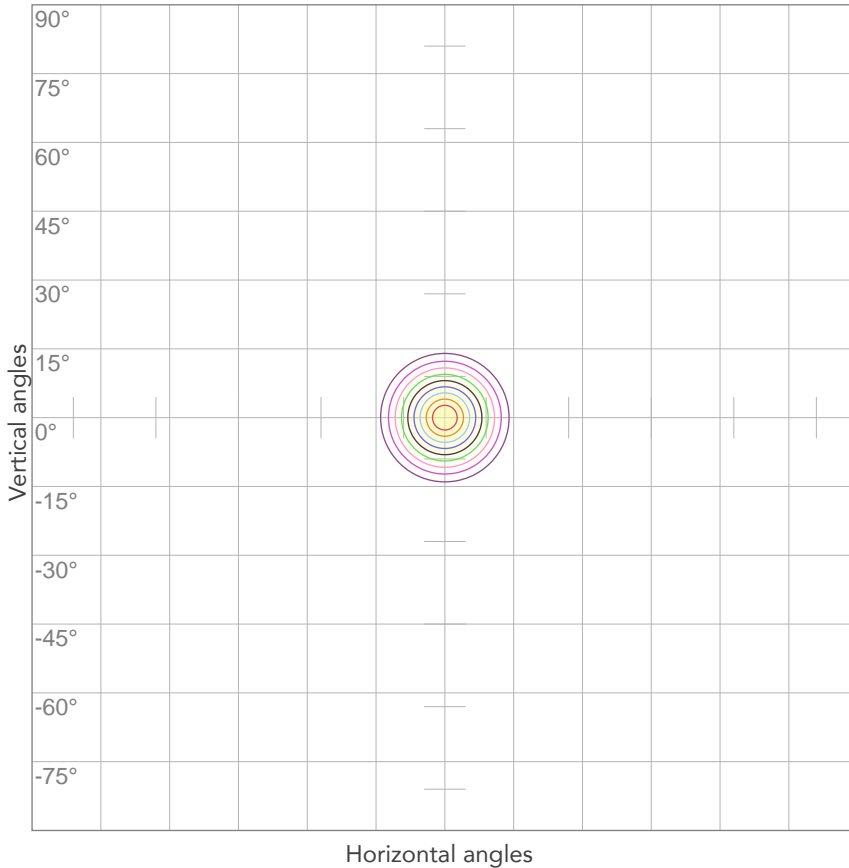

10%	239 cd
20%	477 cd
30%	716 cd
40%	954 cd
50%	1193 cd
60%	1432 cd
70%	{LUX_1M70} cd
80%	1909 cd

Conditions:  
 Number of c-planes: 2  
 Candela at center: 2386 cd

## ISO LUX DIAGRAM

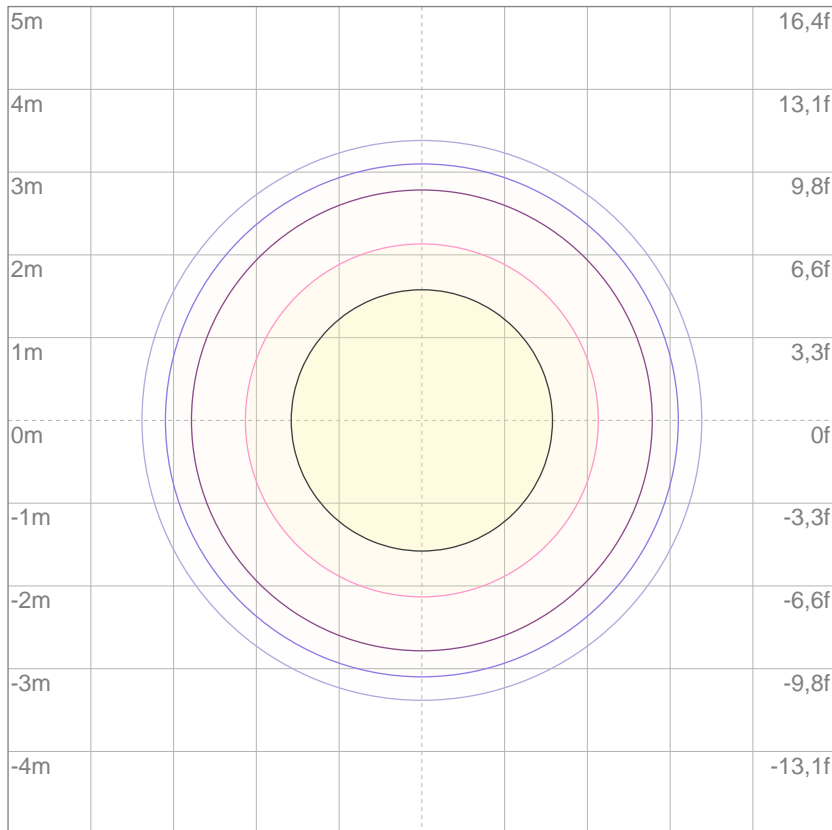

3%	0,716 lx
5%	1,19 lx
10%	2,39 lx
30%	7,16 lx
50%	11,9 lx

Conditions:  
 Number of c-planes: 2  
 Lux at center: 23,9 lx

*Lux distribution on a surface when lamp is mounted at 10 meters from the surface.*

Mounting height: 10 meters (33 feet)



Total lumen output:

6745 lm

Total candela output:

7473 cd

**PRODUCT NAME:**

EclipseFresnel TW

**MEASUREMENT CONDITIONS:**

Beam angle:

45°

Target:

Lime

Operator:

Marco Marrocco

Date and time:

14/12/2019 10:39:49

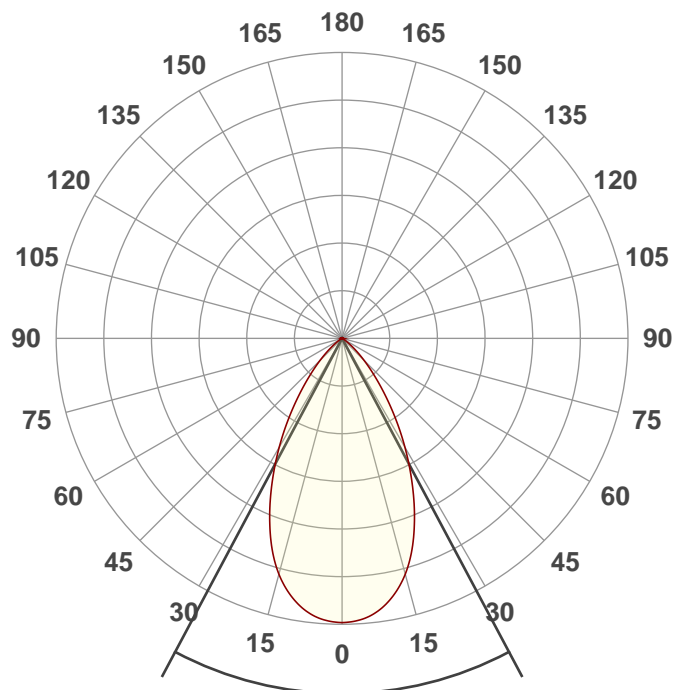

Beam angle

**56,1°**

Spectra

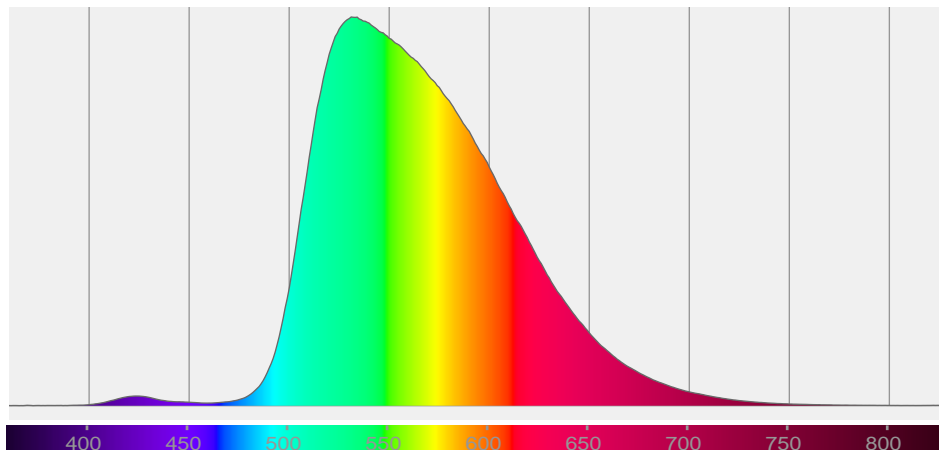

# BEAM DETAILS



Beam angle 50%	Field angle 10%	Cutoff angle 2,5%	Intensity ratio in 120° cone	Intensity ratio in 90° cone
56,1°	91,4°	107,9°	99,5%	93,7%

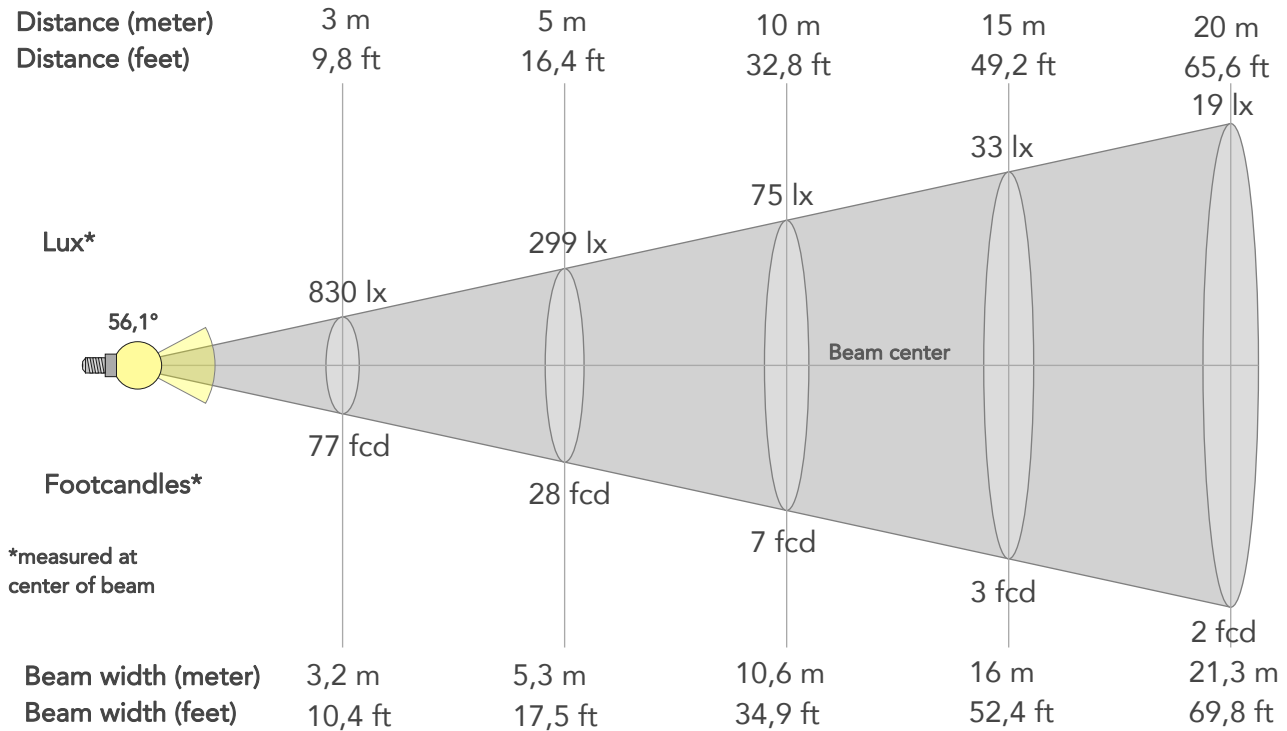

## BEAM INTENSITIES AND WIDTHS

Distance	1m	2m	3m	4m	5m	7,5m	10m	15m	20m	25m	30m	40m	50m
Distance	3,3ft	6,6ft	9,8ft	13,1ft	16,4ft	24,6ft	32,8ft	49,2ft	65,6ft	82ft	98,4ft	131,2ft	164ft
Lux	7473lx	1868lx	830lx	467lx	299lx	133lx	75lx	33lx	19lx	12lx	8lx	5lx	3lx
Footcand.	694fcd	174fcd	77fcd	43fcd	28fcd	12fcd	7fcd	3fcd	2fcd	1fcd	1fcd	0fcd	0fcd
Beam wid.	1,1m	2,1m	3,2m	4,3m	5,3m	8m	10,6m	16m	21,3m	26,6m	31,9m	42,6m	53,2m
Beam wid.	3,5ft	7ft	10,4ft	13,9ft	17,5ft	26,2ft	34,9ft	52,4ft	69,8ft	87,3ft	104,8ft	139,7ft	174,6ft

## LINEAR DISTRIBUTION DIAGRAM

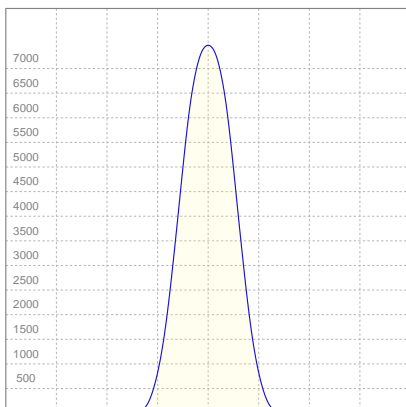

## ELECTRICAL SPECIFICATIONS

Input voltage	Input current	Input power	Effeciency
227V	0,630A	125,7W	54lm/W

## ISO CANDELA DIAGRAM

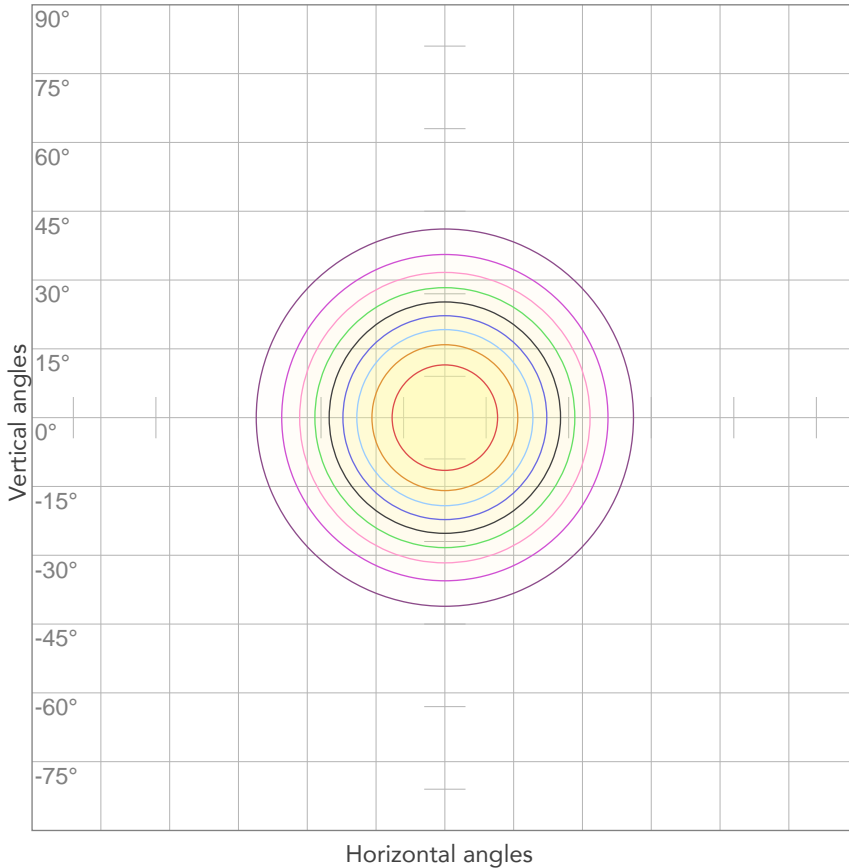

10%	747 cd
20%	1495 cd
30%	2242 cd
40%	2989 cd
50%	3737 cd
60%	4484 cd
70%	{LUX_1M70} cd
80%	5978 cd

**Conditions:**  
 Number of c-planes: 2  
 Candela at center: 7473 cd

## ISO LUX DIAGRAM

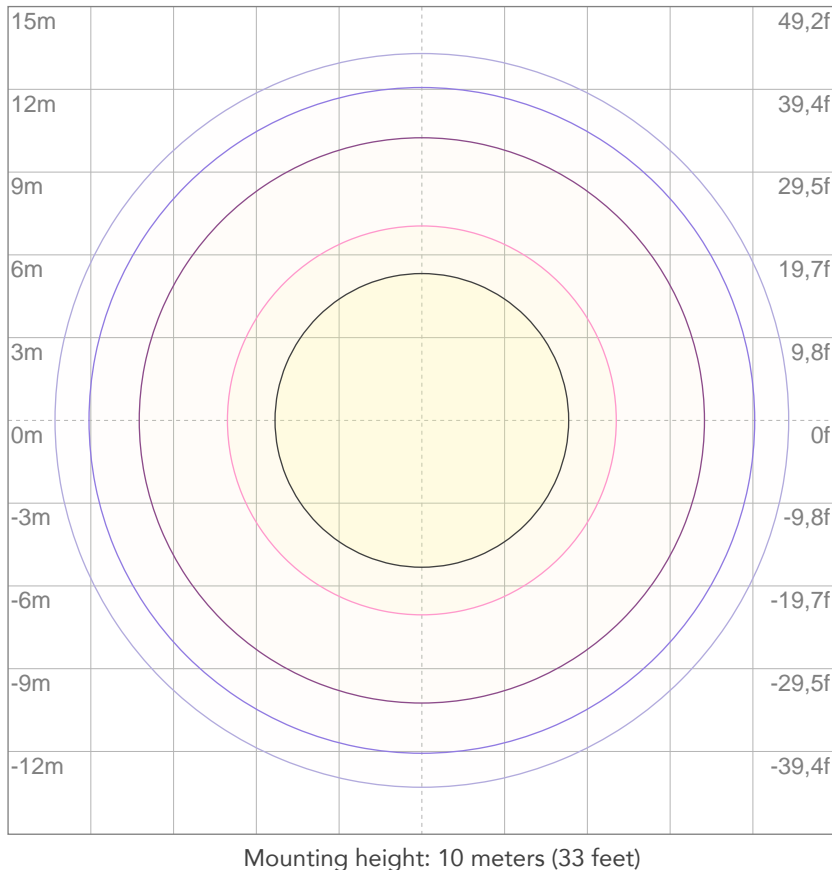

3%	2,24 lx
5%	3,74 lx
10%	7,47 lx
30%	22,4 lx
50%	37,4 lx

**Conditions:**  
 Number of c-planes: 2  
 Lux at center: 74,7 lx

*Lux distribution on a surface when lamp is mounted at 10 meters from the surface.*



Total lumen output:

6261 lm

Total candela output:

20156 cd

**PRODUCT NAME:**

EclipseFresnel TW

**MEASUREMENT CONDITIONS:**

Beam angle:

30°

Target:

Lime

Operator:

Marco Marrocco

Date and time:

14/12/2019 12:15:20

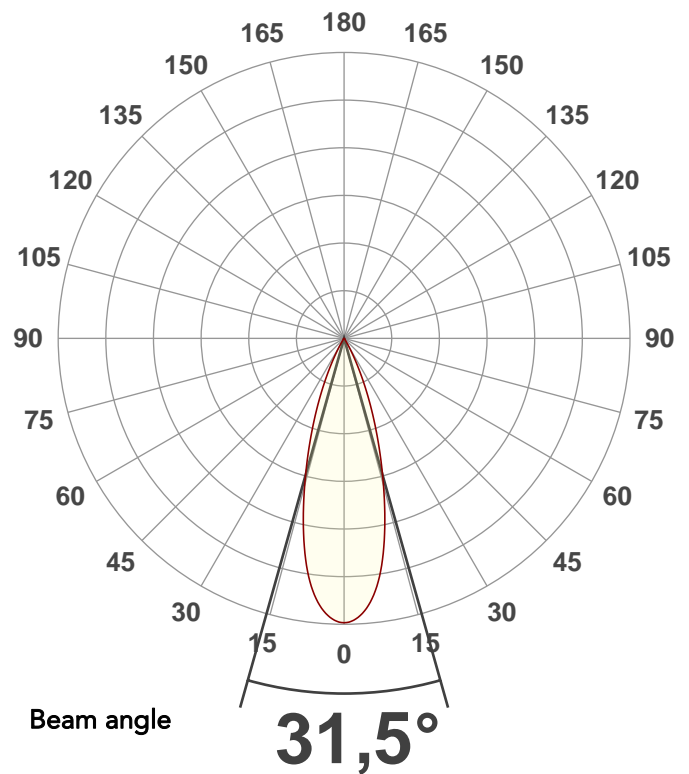

Spectra

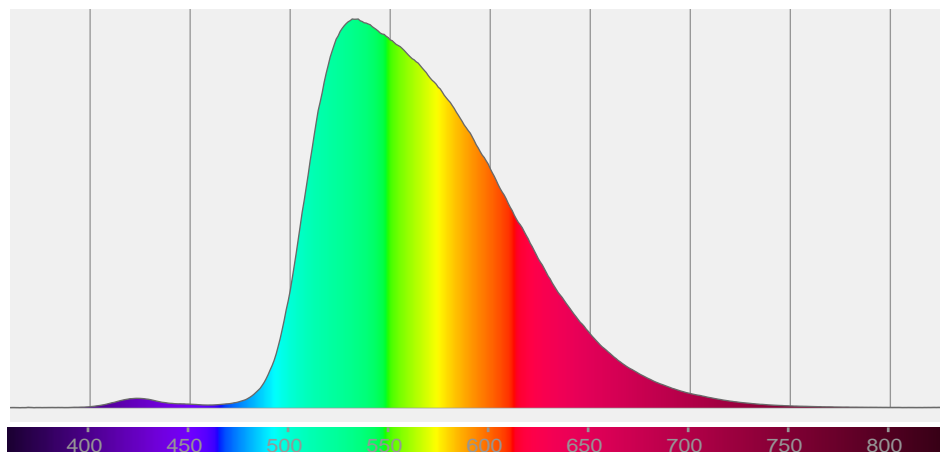

# BEAM DETAILS



Beam angle 50%	Field angle 10%	Cutoff angle 2,5%	Intensity ratio in 120° cone	Intensity ratio in 90° cone
31,5°	52,9°	62°	99,4%	98,2%

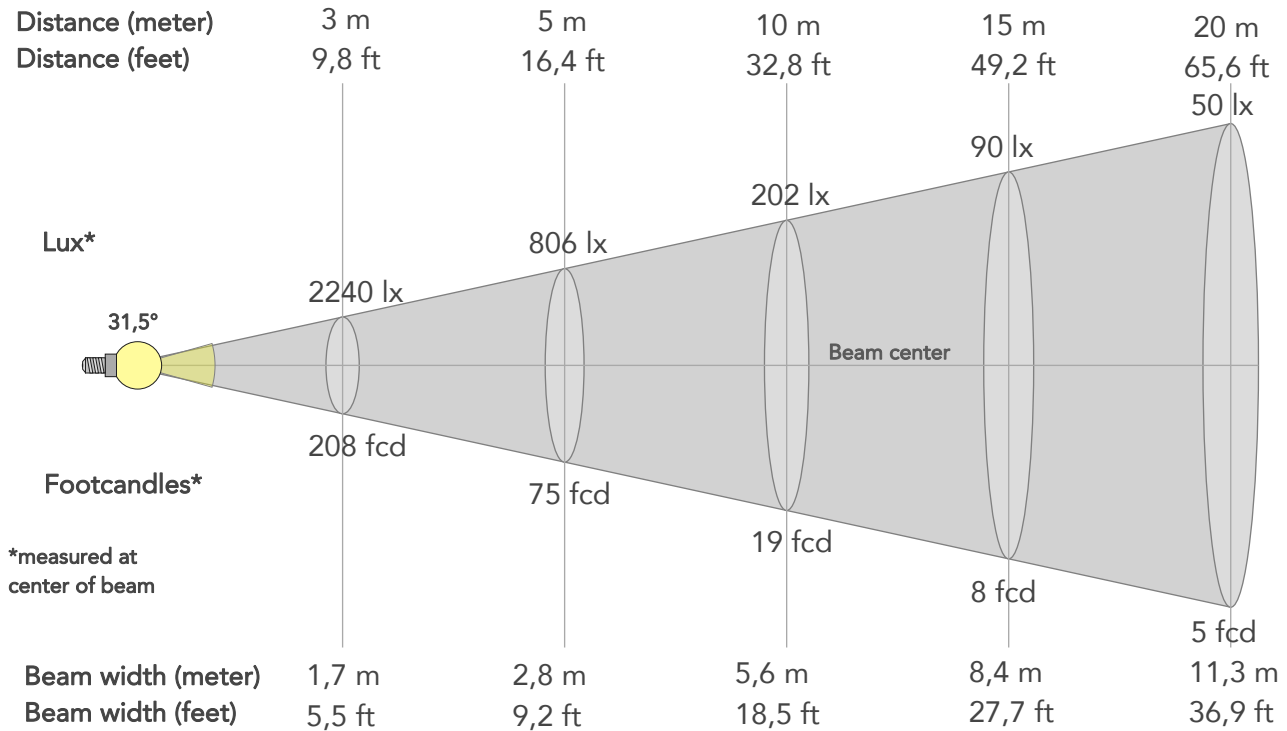

## BEAM INTENSITIES AND WIDTHS

Distance	1m	2m	3m	4m	5m	7,5m	10m	15m	20m	25m	30m	40m	50m
Distance	3,3ft	6,6ft	9,8ft	13,1ft	16,4ft	24,6ft	32,8ft	49,2ft	65,6ft	82ft	98,4ft	131,2ft	164ft
Lux	20156lx	5039lx	2240lx	1260lx	806lx	358lx	202lx	90lx	50lx	32lx	22lx	13lx	8lx
Footcand.	1873fcd	468fcd	208fcd	117fcd	75fcd	33fcd	19fcd	8fcd	5fcd	3fcd	2fcd	1fcd	1fcd
Beam wid.	0,6m	1,1m	1,7m	2,3m	2,8m	4,2m	5,6m	8,4m	11,3m	14,1m	16,9m	22,5m	28,2m
Beam wid.	1,9ft	3,7ft	5,5ft	7,4ft	9,2ft	13,9ft	18,5ft	27,7ft	36,9ft	46,2ft	55,4ft	73,9ft	92,4ft

## LINEAR DISTRIBUTION DIAGRAM

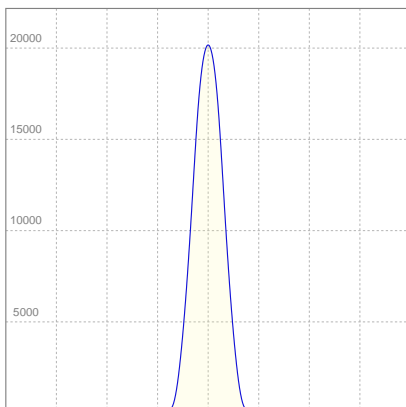

## ELECTRICAL SPECIFICATIONS

Input voltage	Input current	Input power	Effeciency
227V	0,631A	125,8W	50lm/W

## ISO CANDELA DIAGRAM

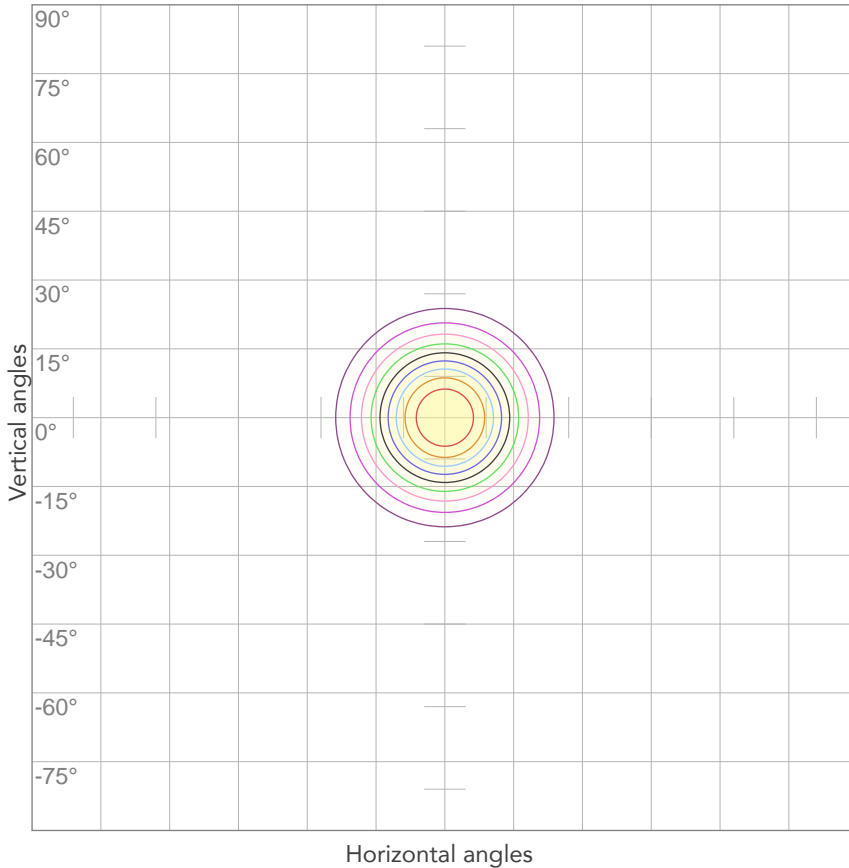

10%	2016 cd
20%	4031 cd
30%	6047 cd
40%	8063 cd
50%	10078 cd
60%	12094 cd
70%	{LUX_1M70} cd
80%	16125 cd

**Conditions:**  
 Number of c-planes: 2  
 Candela at center: 20156 cd

## ISO LUX DIAGRAM

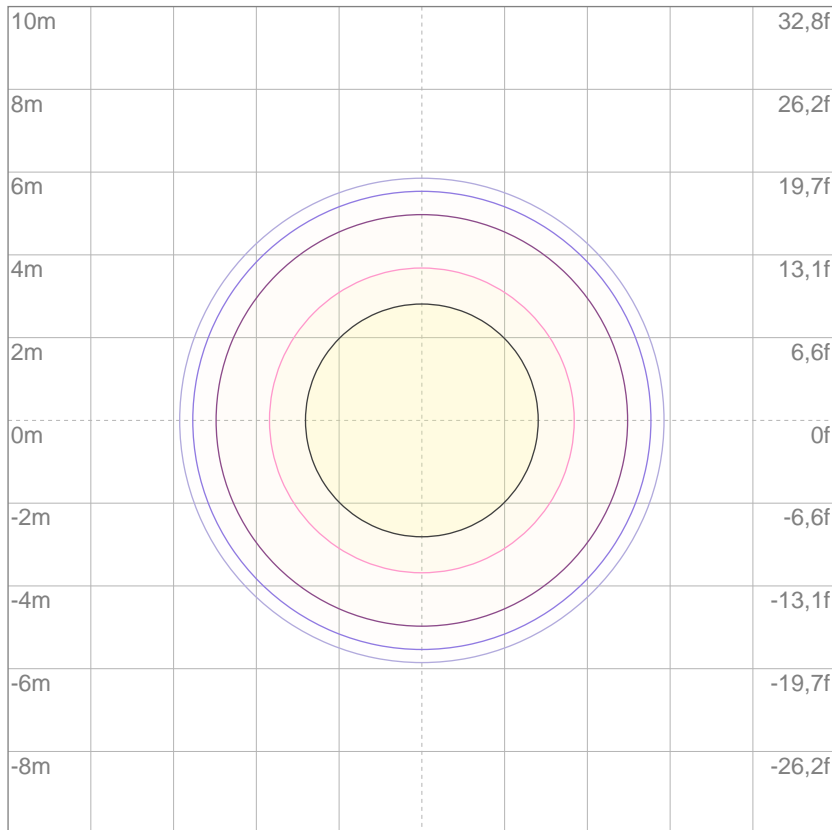

3%	6,05 lx
5%	10,1 lx
10%	20,2 lx
30%	60,5 lx
50%	101 lx

**Conditions:**  
 Number of c-planes: 2  
 Lux at center: 202 lx

*Lux distribution on a surface when lamp is mounted at 10 meters from the surface.*

Mounting height: 10 meters (33 feet)





Total lumen output:

4032 lm

Total candela output:

36193 cd

**PRODUCT NAME:**

EclipseFresnel TW

**MEASUREMENT CONDITIONS:**

Beam angle:

15°

Target:

Lime

Operator:

Marco Marrocco

Date and time:

14/12/2019 11:43:23

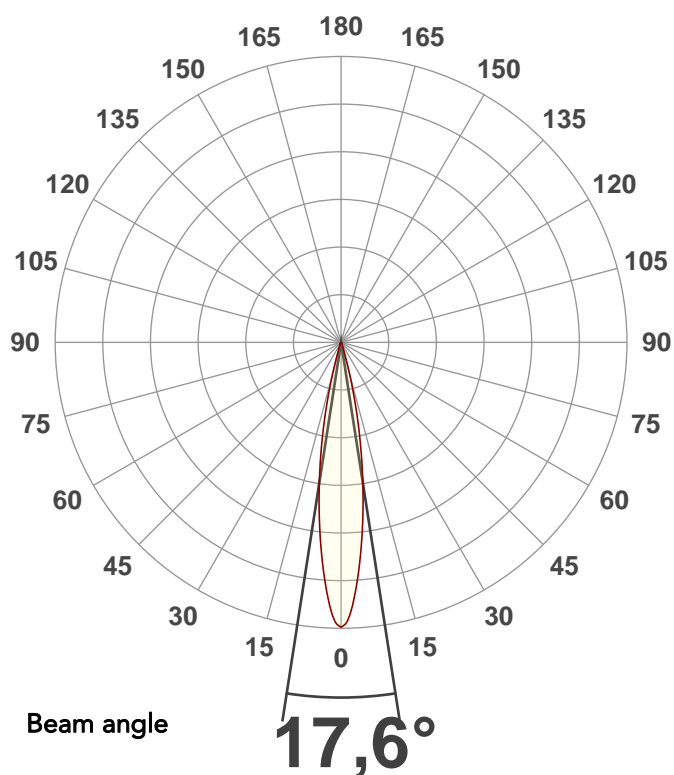

Spectra

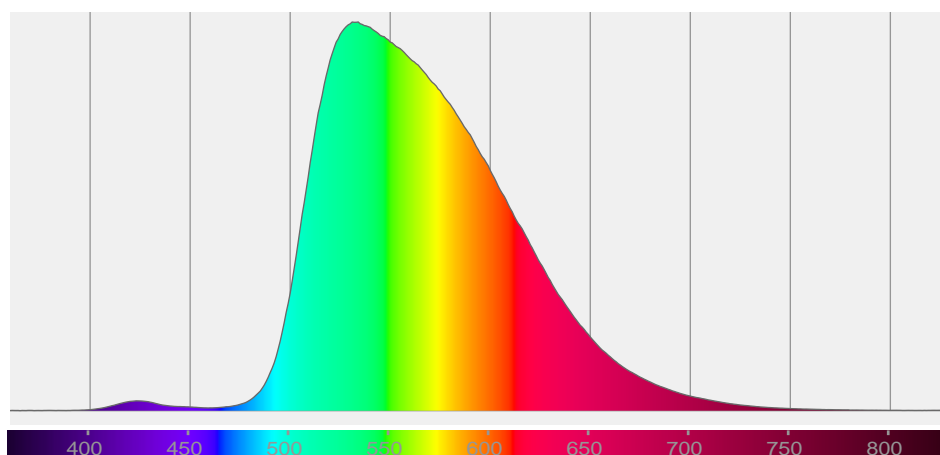

Beam angle 50%	Field angle 10%	Cutoff angle 2,5%	Intensity ratio in 120° cone	Intensity ratio in 90° cone
17,6°	30,9°	38,1°	99,1%	97,5%

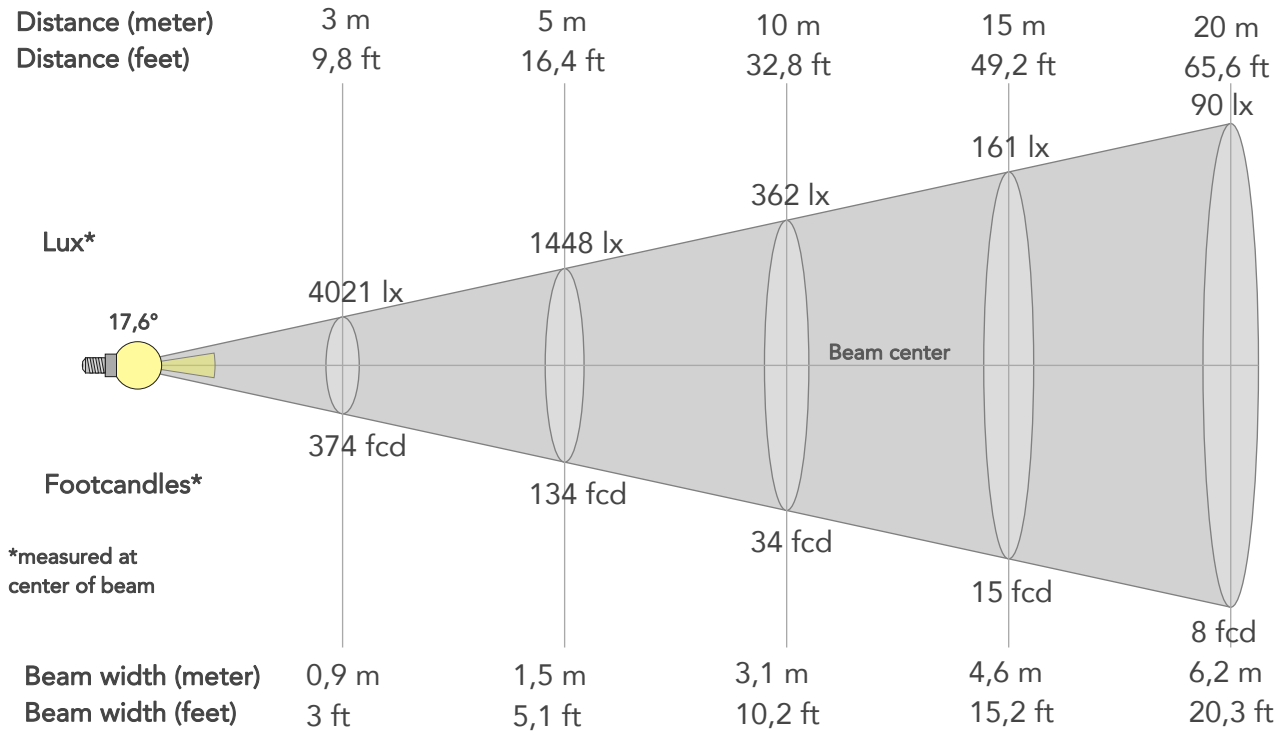

## BEAM INTENSITIES AND WIDTHS

Distance	1m	2m	3m	4m	5m	7,5m	10m	15m	20m	25m	30m	40m	50m
Distance	3,3ft	6,6ft	9,8ft	13,1ft	16,4ft	24,6ft	32,8ft	49,2ft	65,6ft	82ft	98,4ft	131,2ft	164ft
Lux	36193lx	9048lx	4021lx	2262lx	1448lx	643lx	362lx	161lx	90lx	58lx	40lx	23lx	14lx
Footcand.	3362fcd	841fcd	374fcd	210fcd	134fcd	60fcd	34fcd	15fcd	8fcd	5fcd	4fcd	2fcd	1fcd
Beam wid.	0,3m	0,6m	0,9m	1,2m	1,5m	2,3m	3,1m	4,6m	6,2m	7,7m	9,3m	12,4m	15,5m
Beam wid.	1ft	2ft	3ft	4,1ft	5,1ft	7,6ft	10,2ft	15,2ft	20,3ft	25,4ft	30,5ft	40,7ft	50,8ft

## LINEAR DISTRIBUTION DIAGRAM

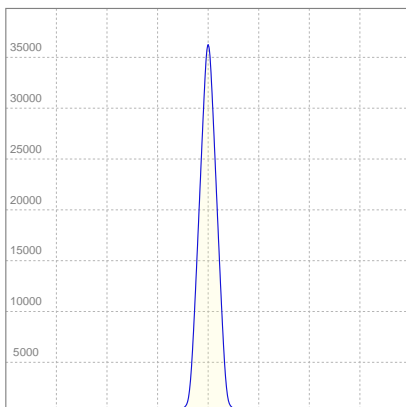

## ELECTRICAL SPECIFICATIONS

Input voltage	Input current	Input power	Effeciency
228V	0,628A	126W	32lm/W

## ISO CANDELA DIAGRAM

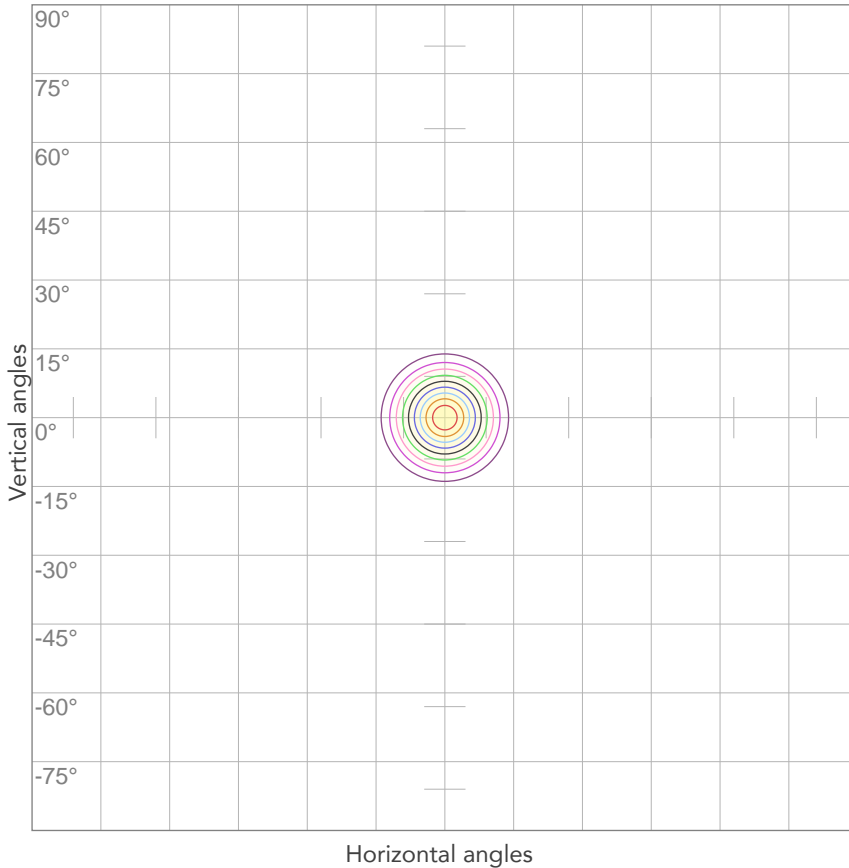

10%	3619 cd
20%	7239 cd
30%	10858 cd
40%	14477 cd
50%	18097 cd
60%	21716 cd
70%	{LUX_1M70} cd
80%	28955 cd

**Conditions:**

Number of c-planes: 2

Candela at center: 36193 cd

## ISO LUX DIAGRAM

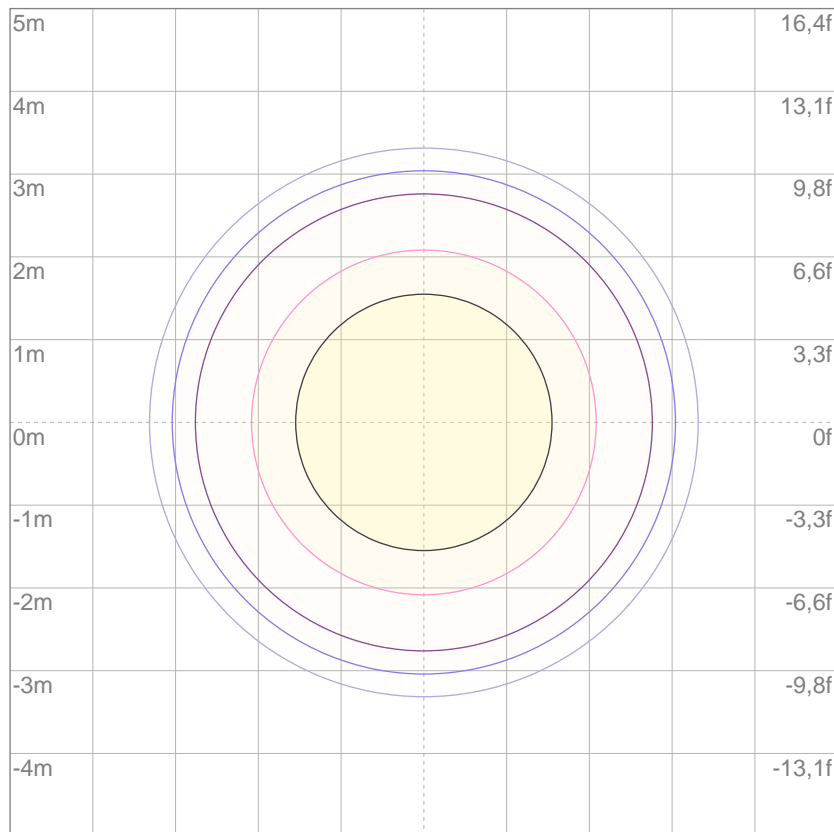

3%	10,9 lx
5%	18,1 lx
10%	36,2 lx
30%	109 lx
50%	181 lx

**Conditions:**

Number of c-planes: 2

Lux at center: 362 lx

*Lux distribution on a surface when lamp is mounted at 10 meters from the surface.*

Mounting height: 10 meters (33 feet)



Total lumen output:

7851 lm

Total candela output:

8578 cd

Light quality:

CRI: 91,5

Color temperature:

2816 K

## PRODUCT NAME:

EclipseFresnel TW

## MEASUREMENT CONDITIONS:

Beam angle:

45°

Target:

2800K

Operator:

Marco Marrocco

Date and time:

14/12/2019 10:42:50

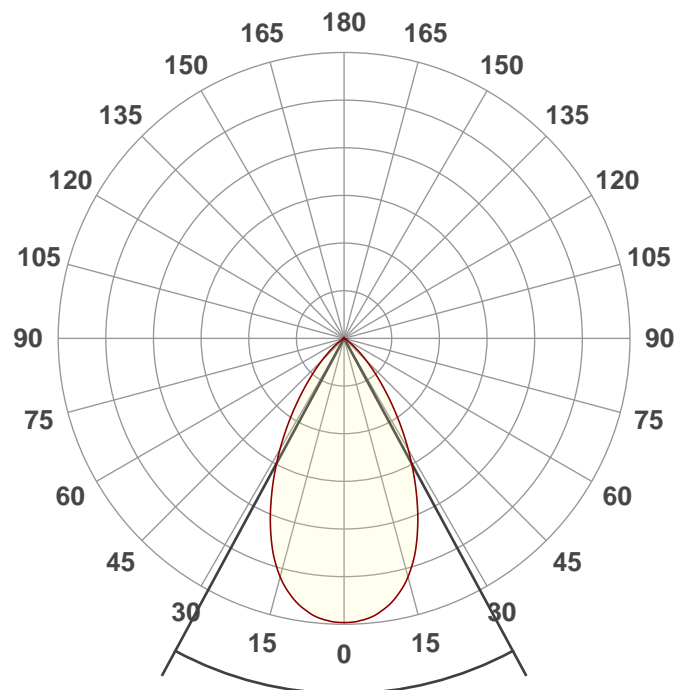

Beam angle

56,7°

Spectra

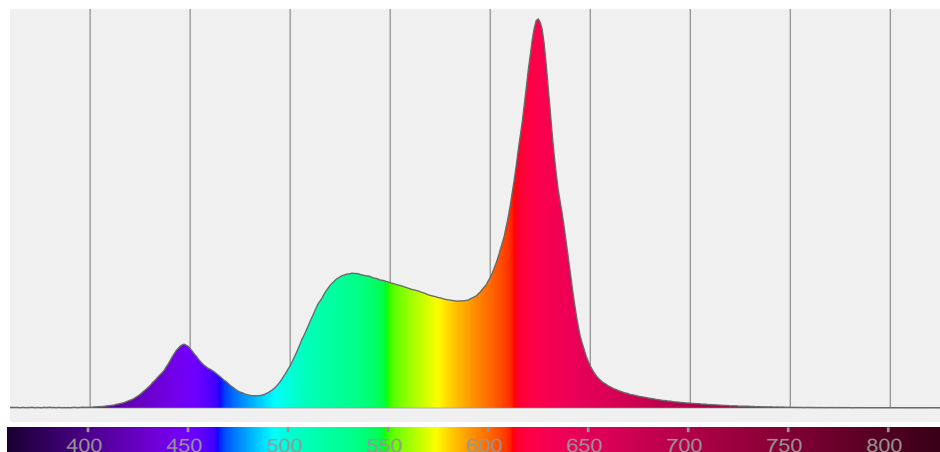

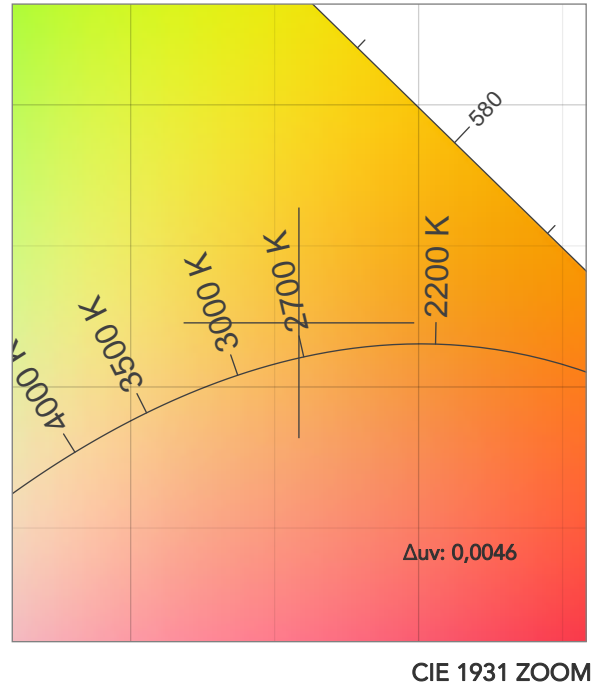
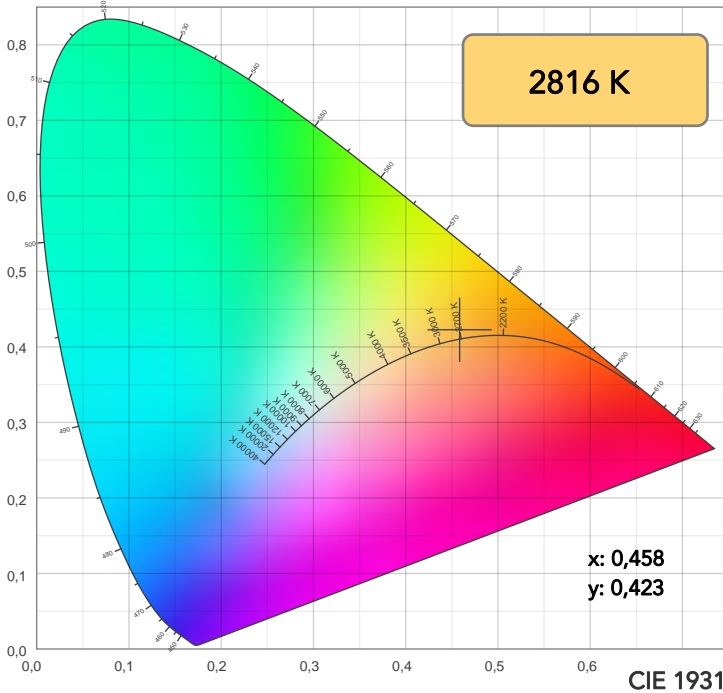

TM30: 87,2

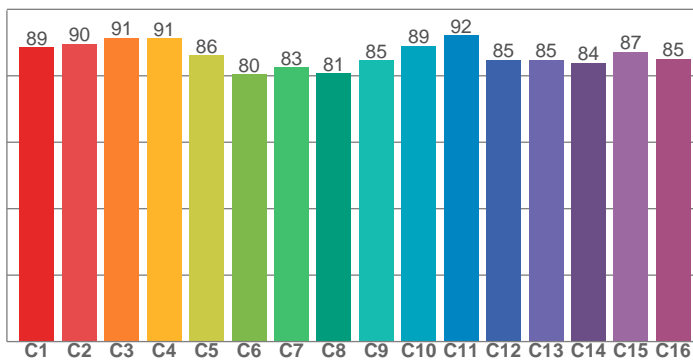

CRI: 91,5 (R1-R8)

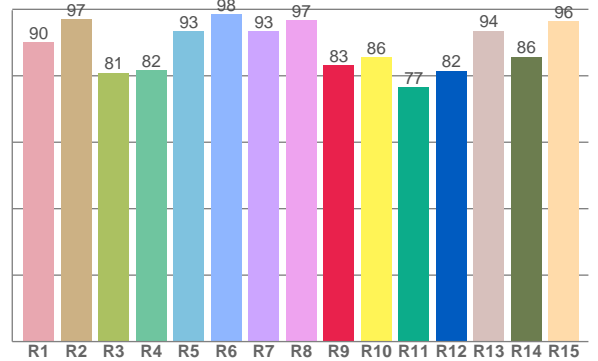

CQS: 87,1

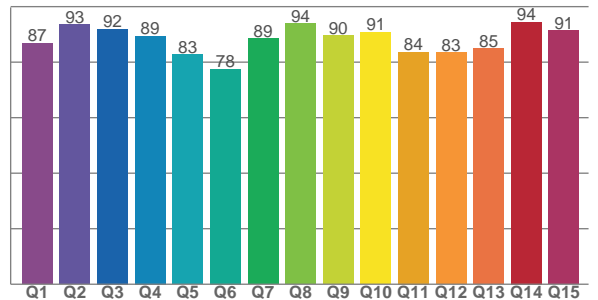

CRI R values, only R1-R8 are used to calculate final CRI value

R1	R2	R3	R4	R5	R6	R7	R8	R9	R10	R11	R12	R13	R14	R15
90,1	97,0	80,9	81,7	93,3	98,4	93,4	96,8	83,1	85,6	76,6	81,6	93,5	85,8	96,4

TM30 C values, 16 binned values out of total of 99 C values

C1	C2	C3	C4	C5	C6	C7	C8	C9	C10	C11	C12	C13	C14	C15	C16
88,5	89,5	91,4	91,2	86,2	80,5	82,6	80,7	84,6	89,0	92,1	84,7	84,9	83,9	87,2	85,0

CQS Q values

Q1	Q2	Q3	Q4	Q5	Q6	Q7	Q8	Q9	Q10	Q11	Q12	Q13	Q14	Q15
86,8	93,5	92,0	89,4	82,8	77,6	88,5	93,8	89,6	90,7	83,7	83,5	84,9	94,5	91,3

COLOR PARAMETERS

Color temperature	Color rendering index	Red component	Color fidelity	Color gamut	Color quality scale	Television lighting index	Color coordinate cie 1931	Color coordinate cie 1931	Color deviation from black body
CCT	CRI	CRI R9	TM30 Rf	TM30 Rg	CQS	TLCI	x	y	Δuv
2816 K	91,5	83,1	87,2	105,8	87,1	70	0,458	0,423	0,0046

# TM30 DETAILS

**Rf 87,2**  
Fidelity index Rf

**Rg 105,8**  
Gammut index

Hue Bin	R <sub>f</sub>	Graphic shifts (%)	
		Chroma	Hue
1	89	-1%	-3%
2	90	1%	-2%
3	91	0%	1%
4	91	2%	4%
5	86	6%	8%
6	80	10%	6%
7	83	9%	-4%
8	81	9%	-6%
9	85	3%	-8%
10	89	-3%	-5%
11	92	-3%	2%
12	85	3%	-2%
13	85	5%	-8%
14	84	3%	-6%
15	87	5%	-2%
16	85	0%	-9%

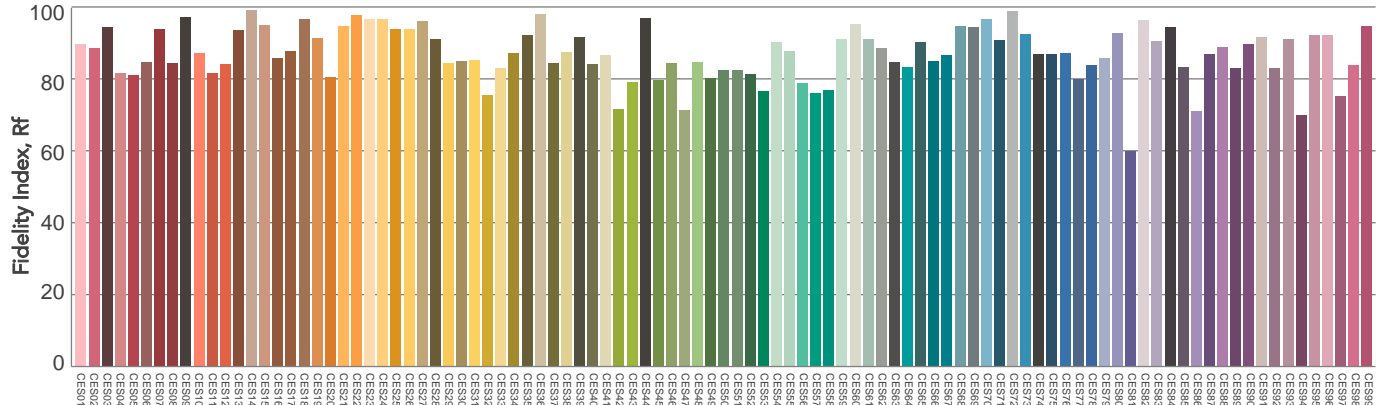
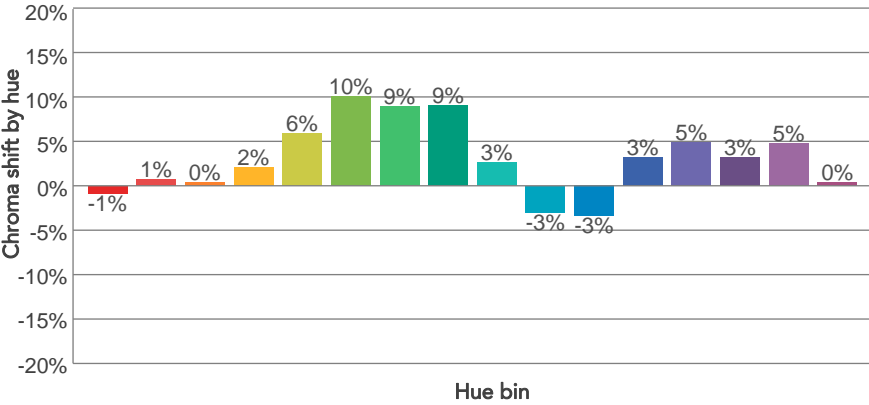
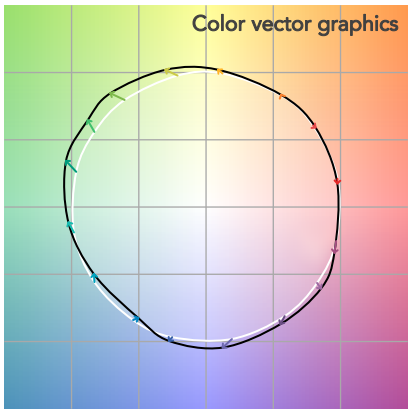
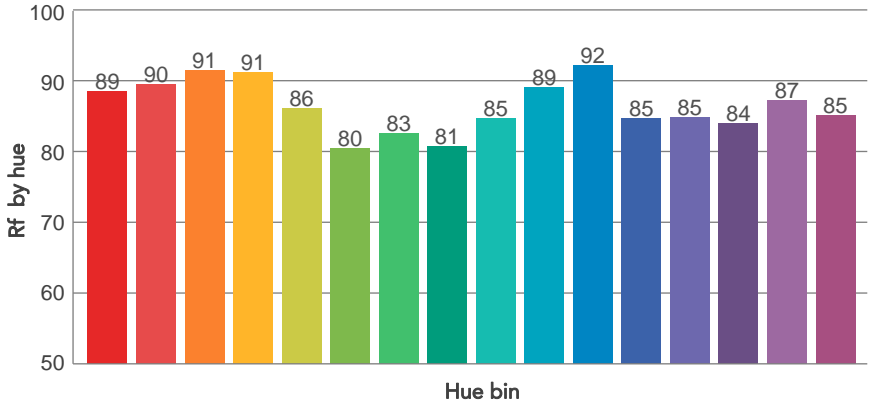
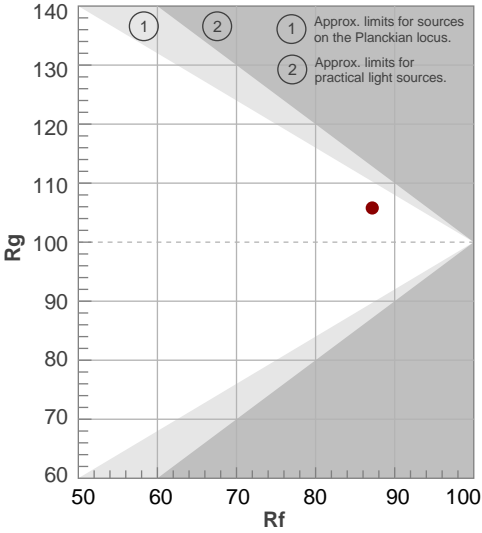

# BEAM DETAILS



Beam angle 50%	Field angle 10%	Cutoff angle 2,5%	Intensity ratio in 120° cone	Intensity ratio in 90° cone
56,7°	91,7°	107,8°	99,6%	93,8%

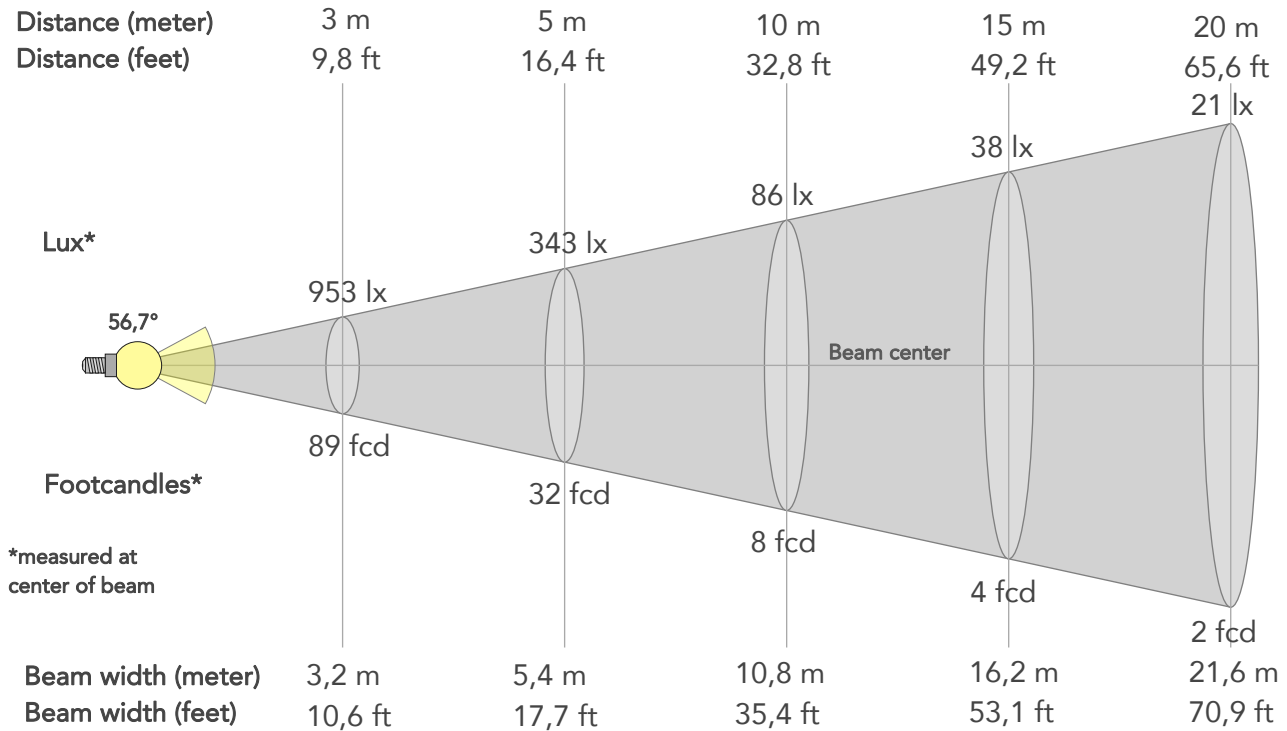

## BEAM INTENSITIES AND WIDTHS

Distance	1m	2m	3m	4m	5m	7,5m	10m	15m	20m	25m	30m	40m	50m
Distance	3,3ft	6,6ft	9,8ft	13,1ft	16,4ft	24,6ft	32,8ft	49,2ft	65,6ft	82ft	98,4ft	131,2ft	164ft
Lux	8578lx	2145lx	953lx	536lx	343lx	153lx	86lx	38lx	21lx	14lx	10lx	5lx	3lx
Footcand.	797fcd	199fcd	89fcd	50fcd	32fcd	14fcd	8fcd	4fcd	2fcd	1fcd	1fcd	0fcd	0fcd
Beam wid.	1,1m	2,2m	3,2m	4,3m	5,4m	8,1m	10,8m	16,2m	21,6m	27m	32,4m	43,2m	54m
Beam wid.	3,6ft	7,1ft	10,6ft	14,1ft	17,7ft	26,6ft	35,4ft	53,1ft	70,9ft	88,6ft	106,3ft	141,7ft	177,1ft

## LINEAR DISTRIBUTION DIAGRAM

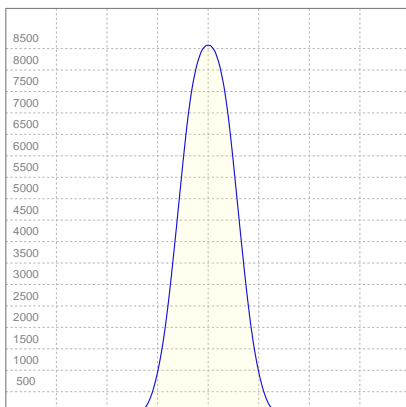

## ELECTRICAL SPECIFICATIONS

Input voltage	Input current	Input power	Effeciency
227V	0,908A	187,5W	42lm/W

## ISO CANDELA DIAGRAM

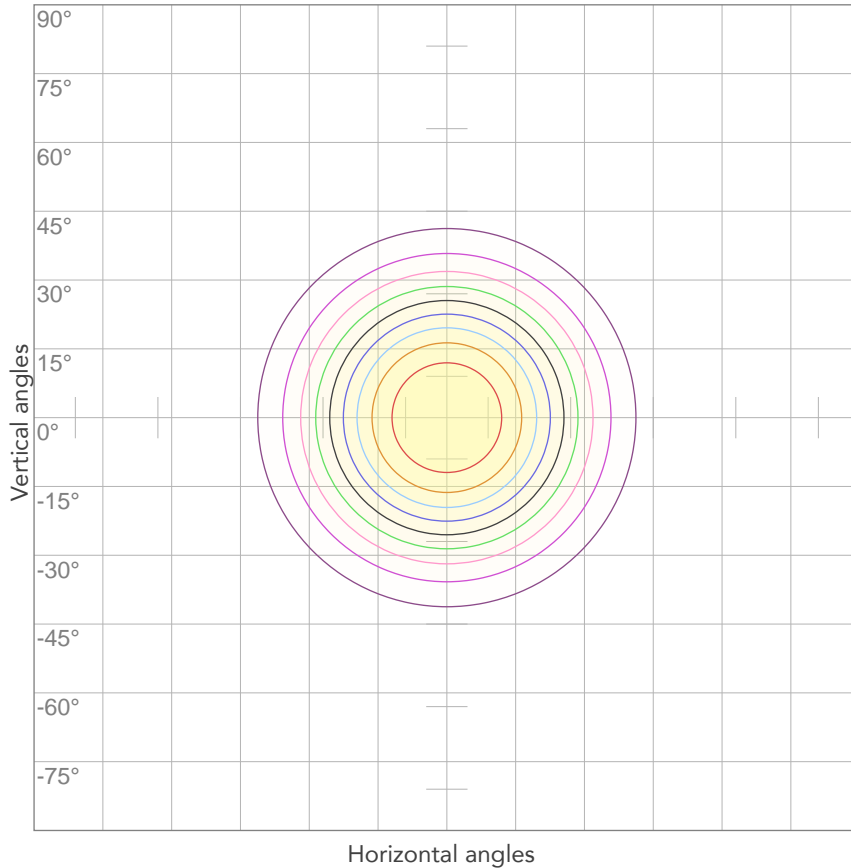

10%	858 cd
20%	1716 cd
30%	2573 cd
40%	3431 cd
50%	4289 cd
60%	5147 cd
70%	6005 cd
80%	6863 cd

Conditions:

Number of c-planes: 2

Candela at center: 8578 cd

## ISO LUX DIAGRAM

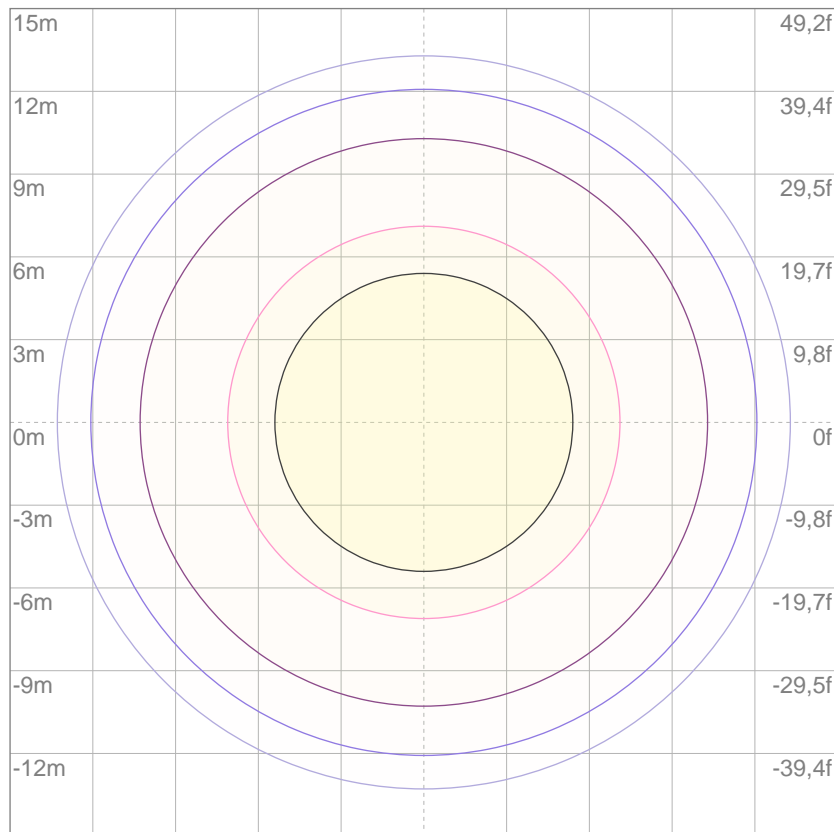

Mounting height: 10 meters (33 feet)

3%	2,57 lx
5%	4,29 lx
10%	8,58 lx
30%	25,7 lx
50%	42,9 lx

Conditions:

Number of c-planes: 2

Lux at center: 85,8 lx

*Lux distribution on a surface when lamp is mounted at 10 meters from the surface.*





Total lumen output:

6874 lm

Total candela output:

21936 cd

Light quality:

CRI: 91,0

Color temperature:

2797 K

## PRODUCT NAME:

EclipseFresnel TW

## MEASUREMENT CONDITIONS:

Beam angle:

30°

Target:

2800K

Operator:

Marco Marrocco

Date and time:

14/12/2019 11:51:05

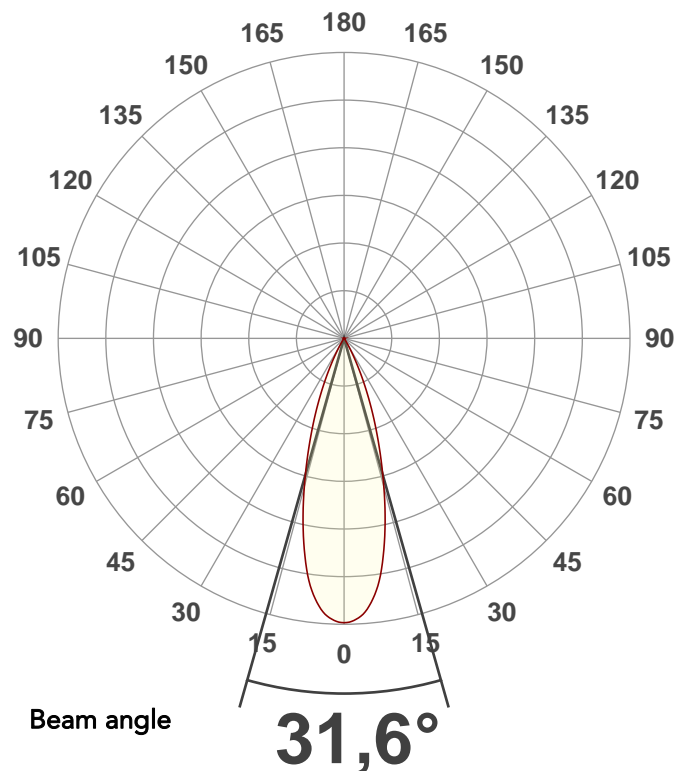

Spectra

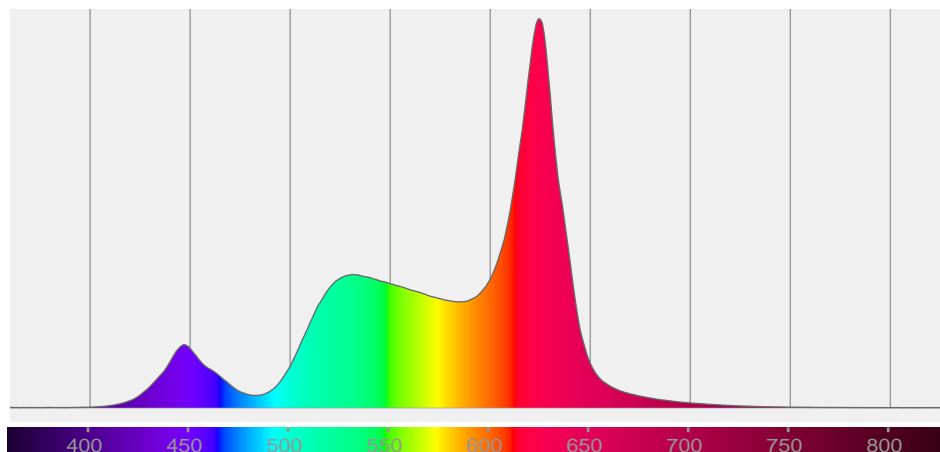

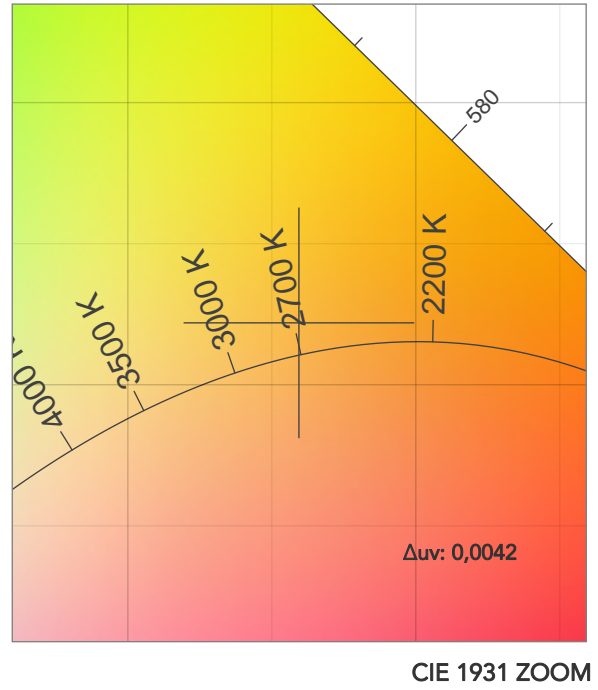
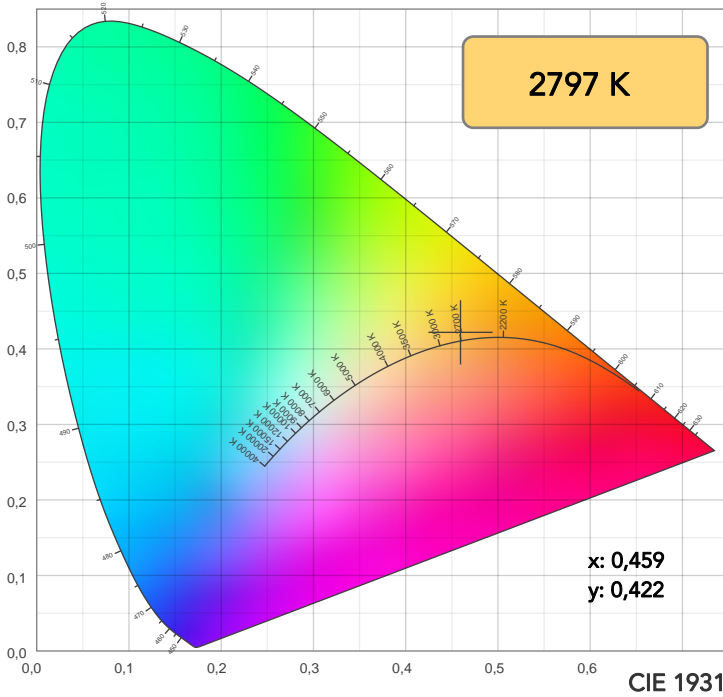

TM30: 87,3

CRI: 91,0 (R1-R8)

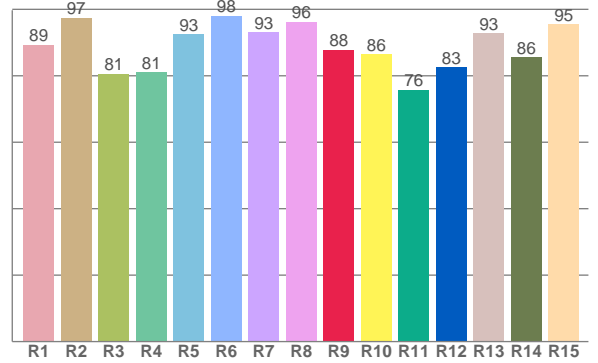
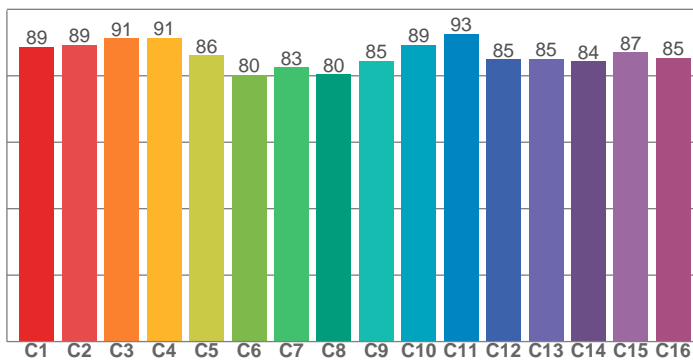

CRI R values, only R1-R8 are used to calculate final CRI value

R1	R2	R3	R4	R5	R6	R7	R8	R9	R10	R11	R12	R13	R14	R15
89,3	97,4	80,6	81,0	92,6	98,1	93,1	96,3	87,8	86,5	75,8	82,6	92,8	85,6	95,4

TM30 C values, 16 binned values out of total of 99 C values

C1	C2	C3	C4	C5	C6	C7	C8	C9	C10	C11	C12	C13	C14	C15	C16
88,8	89,3	91,3	91,4	86,2	80,3	82,5	80,5	84,5	89,2	92,6	84,9	85,0	84,4	87,1	85,4

CQS Q values

Q1	Q2	Q3	Q4	Q5	Q6	Q7	Q8	Q9	Q10	Q11	Q12	Q13	Q14	Q15
87,7	93,4	92,1	89,6	82,7	77,4	88,4	93,8	89,5	91,4	84,2	83,6	84,7	95,0	92,4

CQS: 87,2

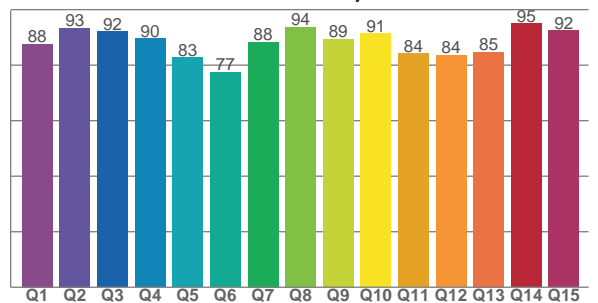

COLOR PARAMETERS

Color temperature	Color rendering index	Red component	Color fidelity	Color gamut	Color quality scale	Television lighting index	Color coordinate cie 1931	Color coordinate cie 1931	Color deviation from black body
CCT	CRI	CRI R9	TM30 Rf	TM30 Rg	CQS	TLCI	x	y	Δuv
2797 K	91,0	87,8	87,3	106,2	87,2	71	0,459	0,422	0,0042

# TM30 DETAILS

**Rf 87,3**  
Fidelity index Rf

**Rg 106,2**  
Gammut index

Hue Bin	R <sub>f</sub>	Graphic shifts (%)	
		Chroma	Hue
1	89	0%	-3%
2	89	1%	-2%
3	91	1%	0%
4	91	2%	4%
5	86	6%	8%
6	80	10%	6%
7	83	9%	-4%
8	80	9%	-7%
9	85	3%	-8%
10	89	-3%	-5%
11	93	-3%	2%
12	85	3%	-2%
13	85	5%	-8%
14	84	3%	-5%
15	87	5%	-2%
16	85	1%	-8%

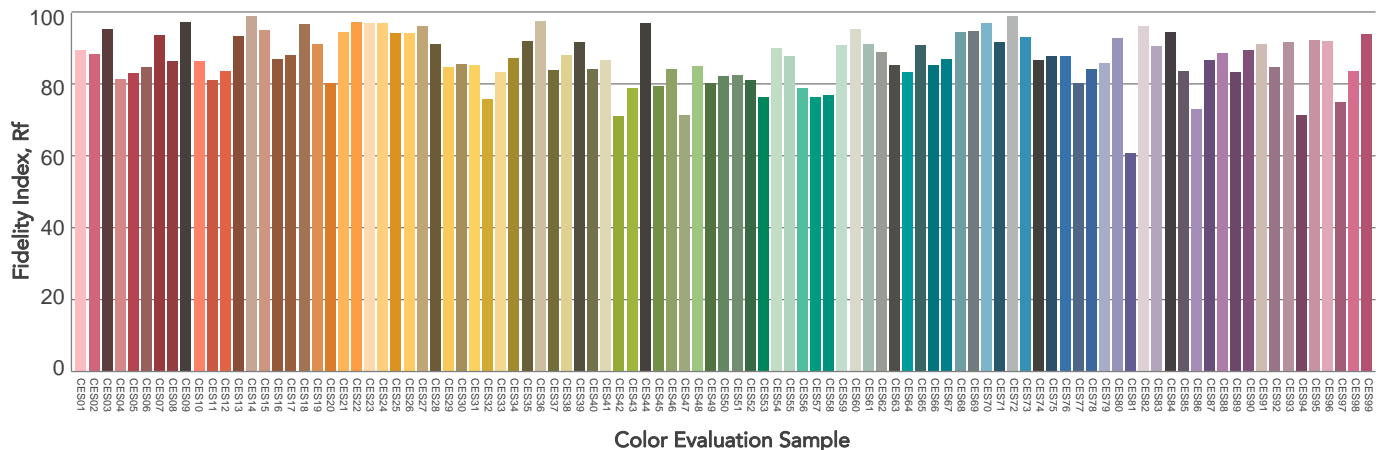
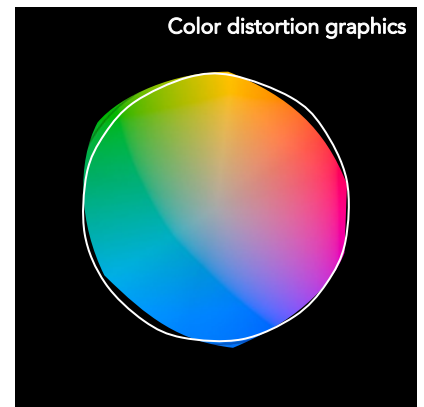
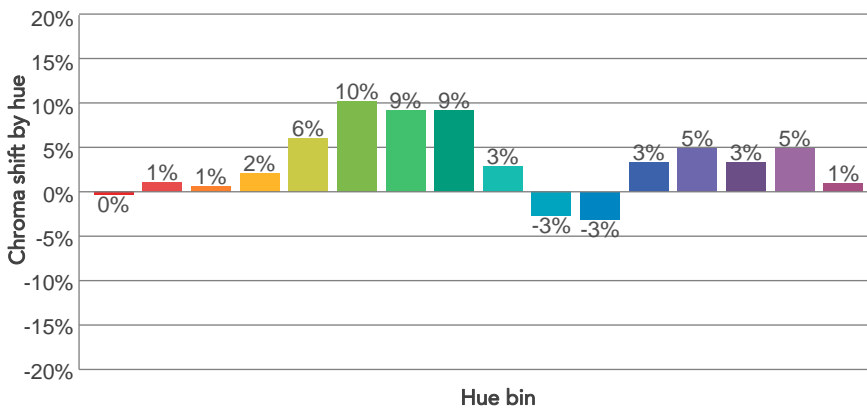
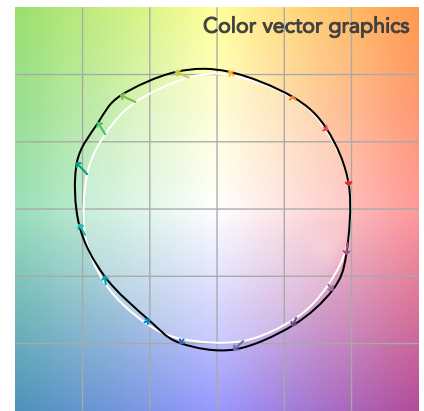
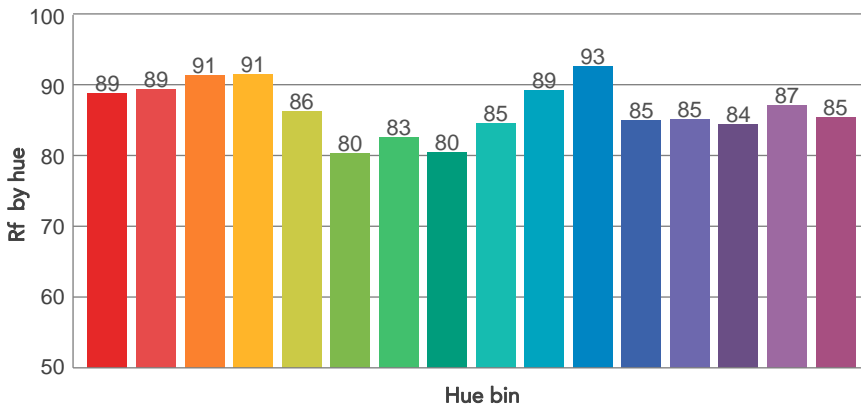
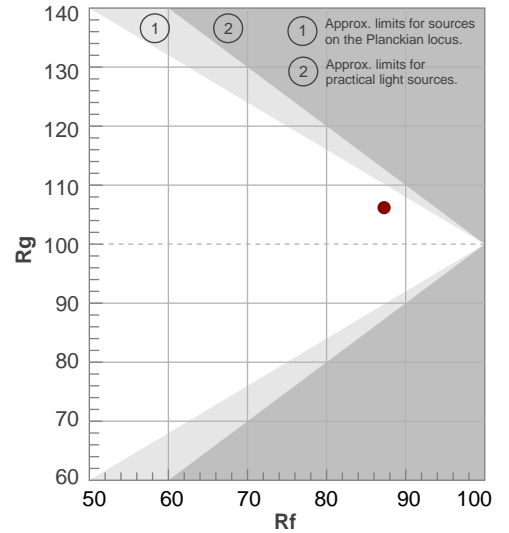

# BEAM DETAILS



Beam angle 50%	Field angle 10%	Cutoff angle 2,5%	Intensity ratio in 120° cone	Intensity ratio in 90° cone
31,6°	53,1°	62,1°	99,4%	98,2%

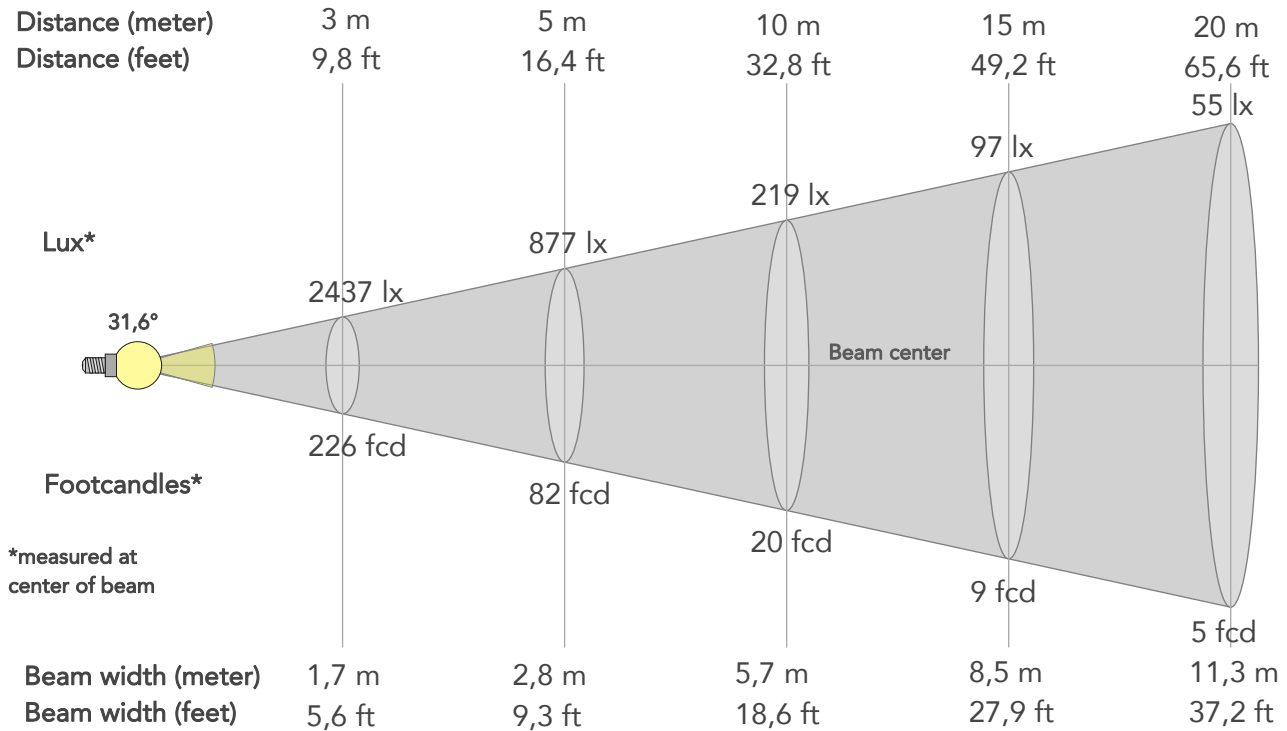

## BEAM INTENSITIES AND WIDTHS

Distance	1m	2m	3m	4m	5m	7,5m	10m	15m	20m	25m	30m	40m	50m
Distance	3,3ft	6,6ft	9,8ft	13,1ft	16,4ft	24,6ft	32,8ft	49,2ft	65,6ft	82ft	98,4ft	131,2ft	164ft
Lux	21936lx	5484lx	2437lx	1371lx	877lx	390lx	219lx	97lx	55lx	35lx	24lx	14lx	9lx
Footcand.	2038fcd	509fcd	226fcd	127fcd	82fcd	36fcd	20fcd	9fcd	5fcd	3fcd	2fcd	1fcd	1fcd
Beam wid.	0,6m	1,1m	1,7m	2,3m	2,8m	4,3m	5,7m	8,5m	11,3m	14,2m	17m	22,7m	28,3m
Beam wid.	1,9ft	3,7ft	5,6ft	7,4ft	9,3ft	13,9ft	18,6ft	27,9ft	37,2ft	46,5ft	55,8ft	74,4ft	92,9ft

## LINEAR DISTRIBUTION DIAGRAM

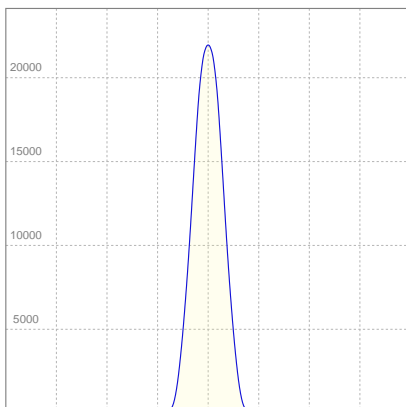

## ELECTRICAL SPECIFICATIONS

Input voltage	Input current	Input power	Effeciency
229V	0,859A	178,7W	38lm/W

## ISO CANDELA DIAGRAM

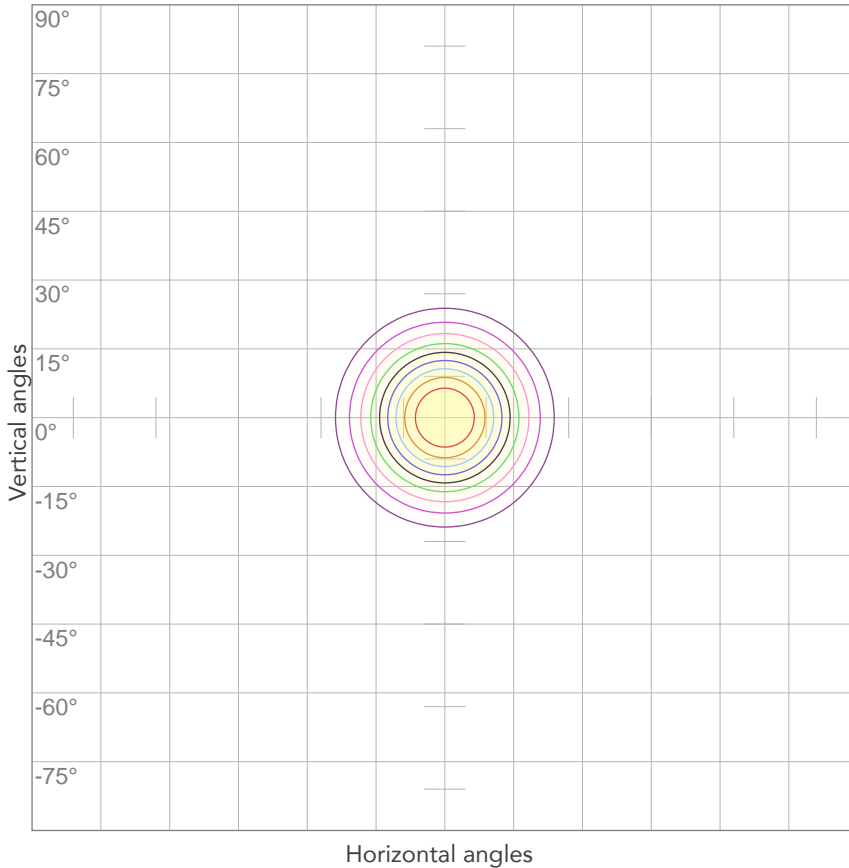

10%	2194 cd
20%	4387 cd
30%	6581 cd
40%	8774 cd
50%	10968 cd
60%	13161 cd
70%	15355 cd
80%	17548 cd

Conditions:

Number of c-planes: 2

Candela at center: 21936 cd

## ISO LUX DIAGRAM

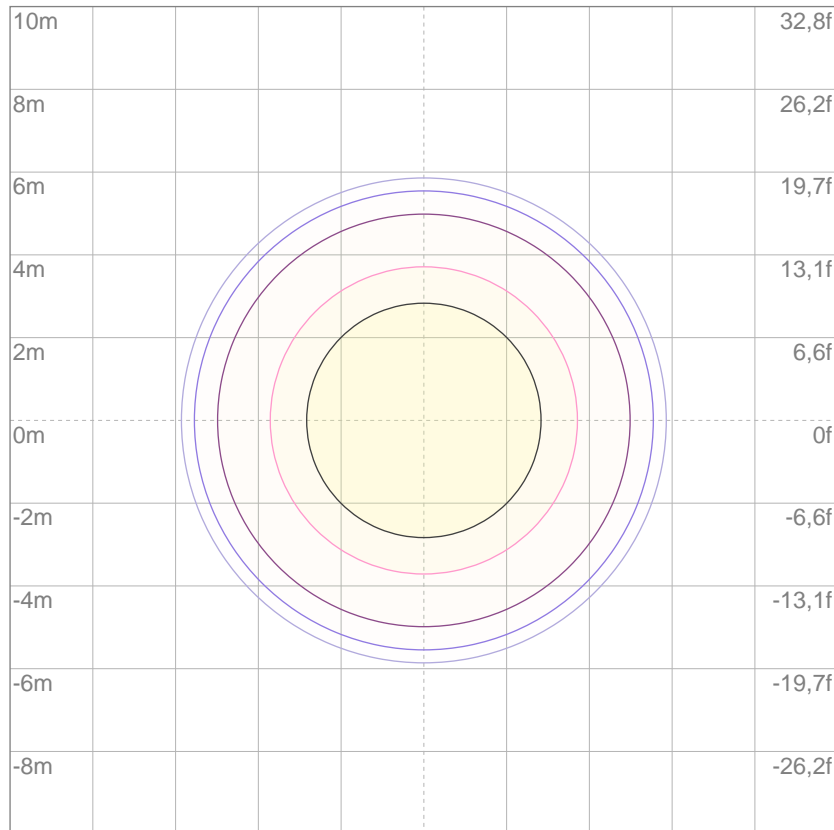

3%	6,58 lx
5%	11,0 lx
10%	21,9 lx
30%	65,8 lx
50%	110 lx

Conditions:

Number of c-planes: 2

Lux at center: 219 lx

*Lux distribution on a surface when lamp is mounted at 10 meters from the surface.*

Mounting height: 10 meters (33 feet)



Total lumen output:

4291 lm

Total candela output:

38890 cd

Light quality:

CRI: 91,4

Color temperature:

2819 K

## PRODUCT NAME:

EclipseFresnel TW

## MEASUREMENT CONDITIONS:

Beam angle:

15°

Target:

2800K

Operator:

Marco Marrocco

Date and time:

14/12/2019 11:10:37

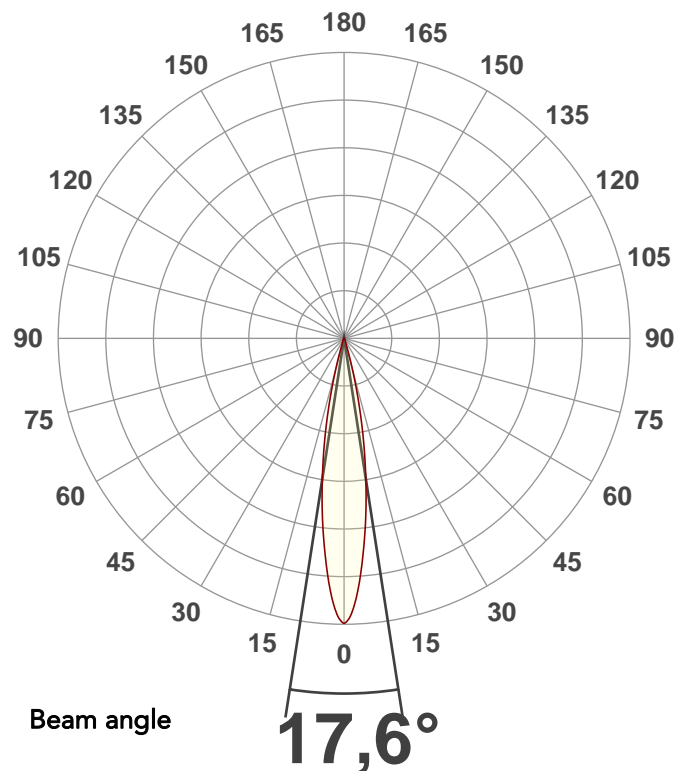

Spectra

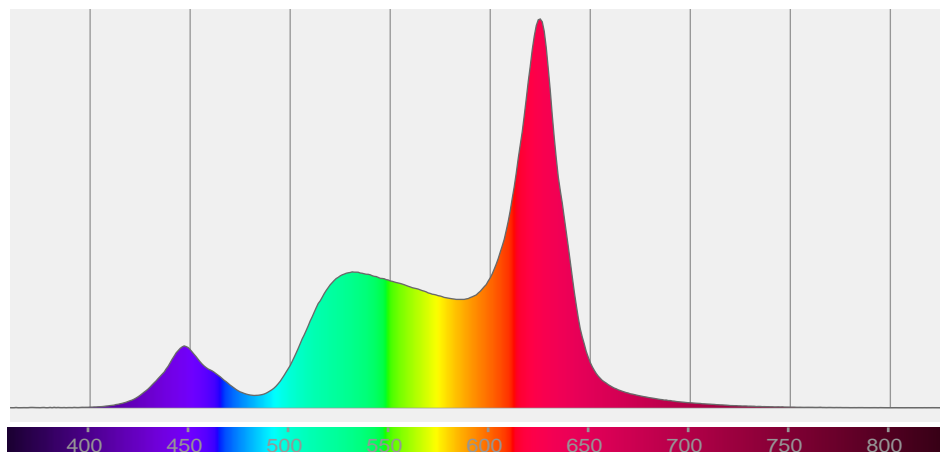

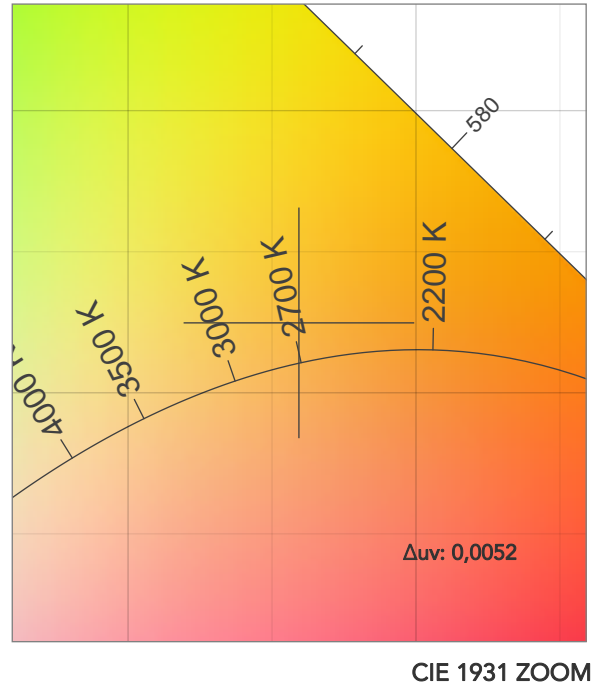
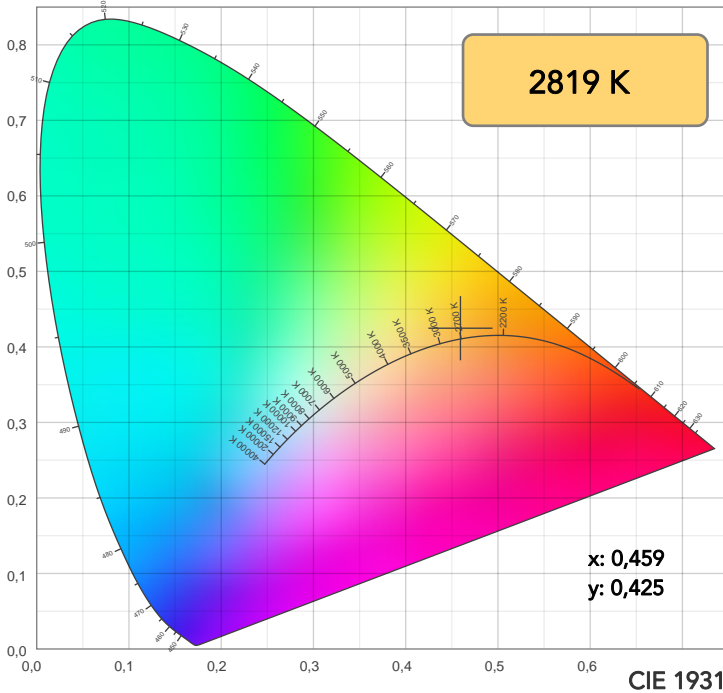

TM30: 87,7

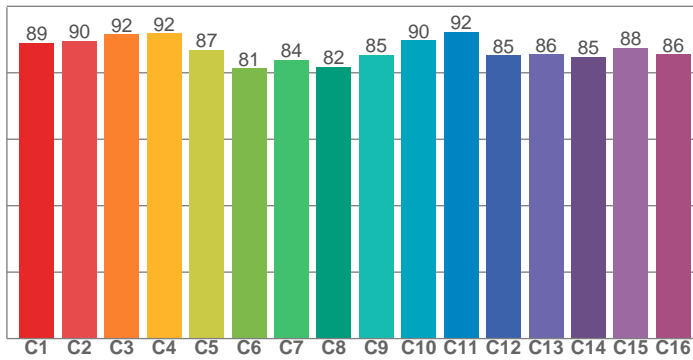

CRI: 91,4 (R1-R8)

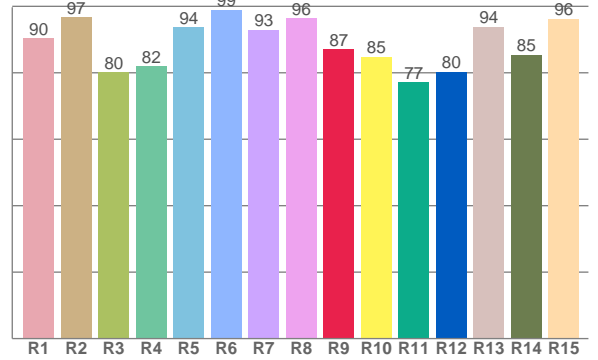

CQS: 87,0

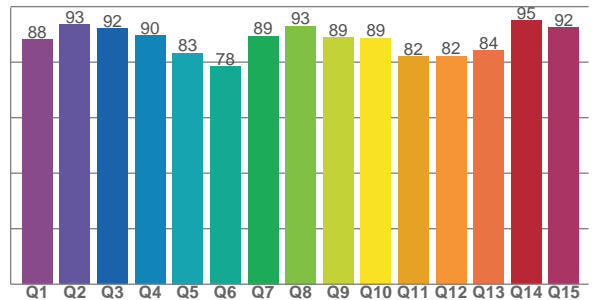

CRI R values, only R1-R8 are used to calculate final CRI value

R1	R2	R3	R4	R5	R6	R7	R8	R9	R10	R11	R12	R13	R14	R15
90,3	96,6	80,2	82,0	93,6	99,0	93,0	96,5	87,0	84,8	77,2	80,3	93,8	85,5	96,3

TM30 C values, 16 binned values out of total of 99 C values

C1	C2	C3	C4	C5	C6	C7	C8	C9	C10	C11	C12	C13	C14	C15	C16
89,0	89,6	91,6	91,9	86,9	81,3	83,9	81,8	85,4	89,7	92,3	85,2	85,6	84,7	87,6	85,6

CQS Q values

Q1	Q2	Q3	Q4	Q5	Q6	Q7	Q8	Q9	Q10	Q11	Q12	Q13	Q14	Q15
88,2	93,5	92,1	89,5	83,3	78,4	89,4	93,1	88,9	88,7	82,0	82,3	84,1	95,0	92,5

COLOR PARAMETERS

Color temperature	Color rendering index	Red component	Color fidelity	Color gamut	Color quality scale	Television lighting index	Color coordinate cie 1931	Color coordinate cie 1931	Color deviation from black body
CCT	CRI	CRI R9	TM30 Rf	TM30 Rg	CQS	TLCI	x	y	Δuv
2819 K	91,4	87,0	87,7	105,4	87,0	73	0,459	0,425	0,0052

# TM30 DETAILS

**Rf 87,7**  
Fidelity index Rf

**Rg 105,4**  
Gammut index

Hue Bin	R <sub>f</sub>	Graphic shifts (%)	
		Chroma	Hue
1	89	-1%	-3%
2	90	1%	-3%
3	92	0%	0%
4	92	1%	3%
5	87	5%	8%
6	81	9%	6%
7	84	8%	-4%
8	82	9%	-6%
9	85	2%	-8%
10	90	-3%	-5%
11	92	-3%	3%
12	85	3%	-2%
13	86	5%	-8%
14	85	3%	-5%
15	88	5%	-1%
16	86	1%	-8%

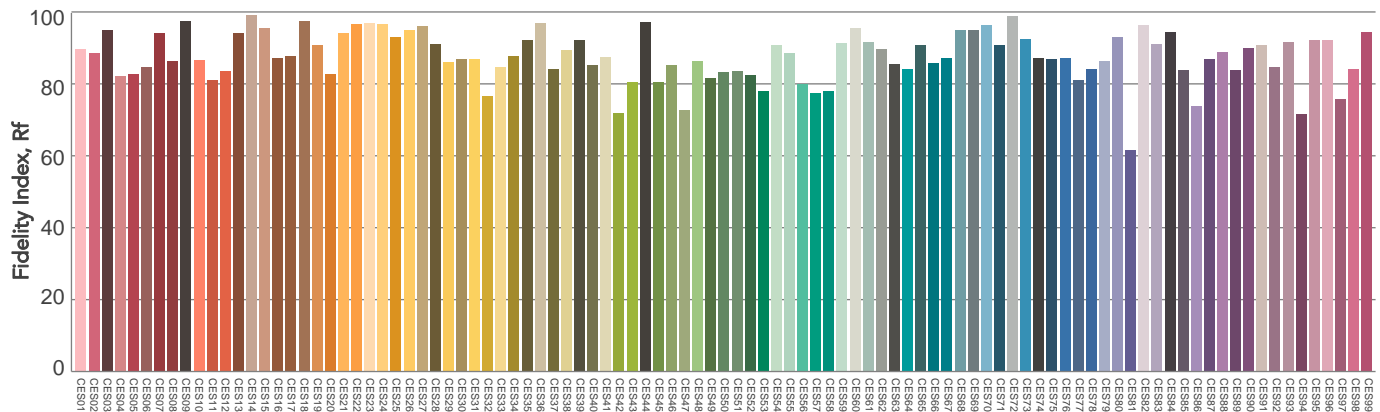
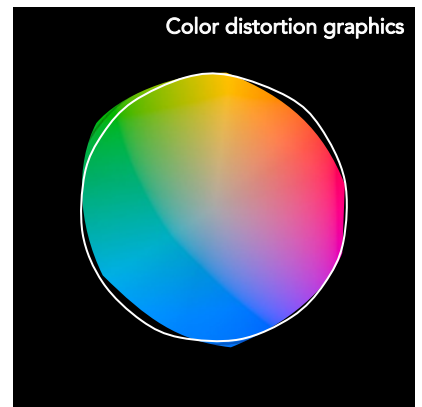
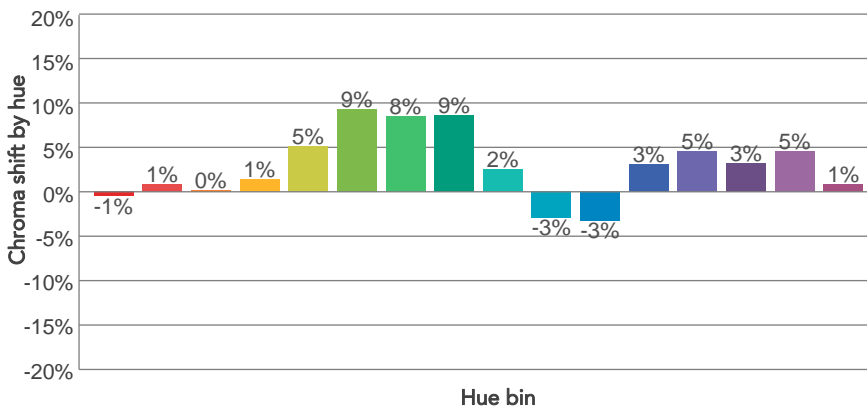
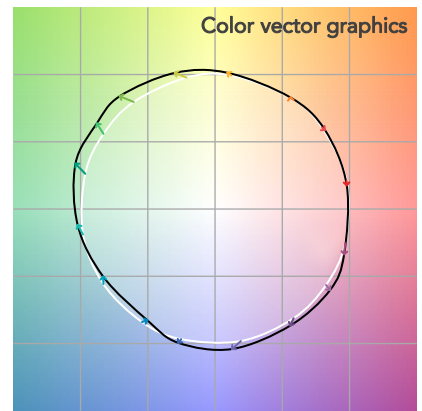
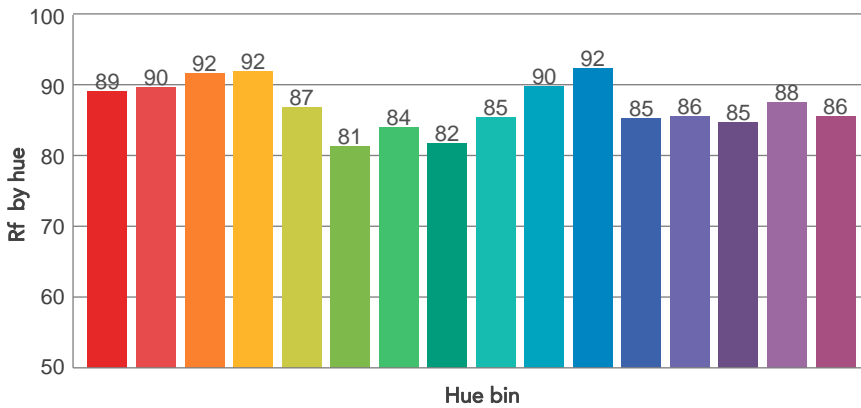
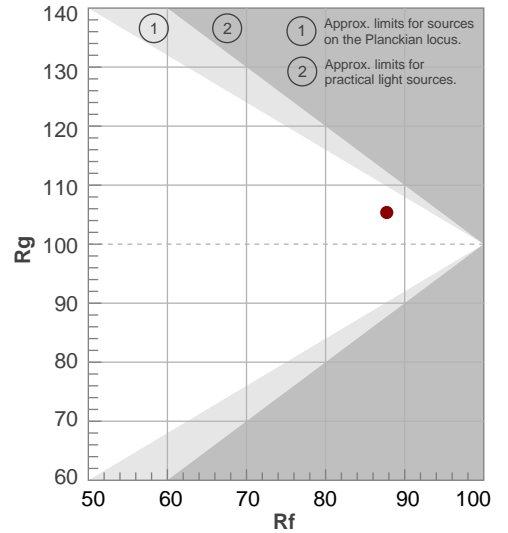

Color Evaluation Sample



# BEAM DETAILS



Beam angle 50%	Field angle 10%	Cutoff angle 2,5%	Intensity ratio in 120° cone	Intensity ratio in 90° cone
17,6°	30,9°	37,9°	99,4%	98,0%

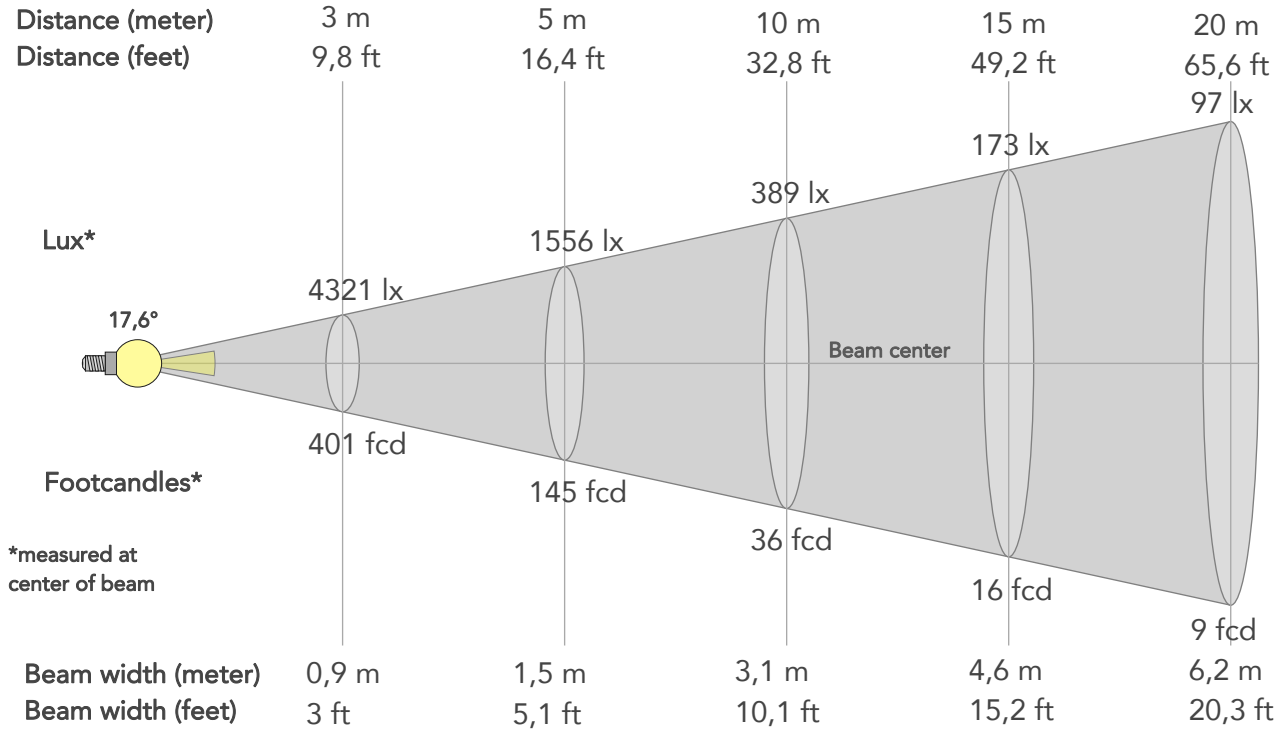

## BEAM INTENSITIES AND WIDTHS

Distance	1m	2m	3m	4m	5m	7,5m	10m	15m	20m	25m	30m	40m	50m
Distance	3,3ft	6,6ft	9,8ft	13,1ft	16,4ft	24,6ft	32,8ft	49,2ft	65,6ft	82ft	98,4ft	131,2ft	164ft
Lux	38890lx	9722lx	4321lx	2431lx	1556lx	691lx	389lx	173lx	97lx	62lx	43lx	24lx	16lx
Footcand.	3613fcd	903fcd	401fcd	226fcd	145fcd	64fcd	36fcd	16fcd	9fcd	6fcd	4fcd	2fcd	1fcd
Beam wid.	0,3m	0,6m	0,9m	1,2m	1,5m	2,3m	3,1m	4,6m	6,2m	7,7m	9,3m	12,4m	15,5m
Beam wid.	1ft	2ft	3ft	4,1ft	5,1ft	7,6ft	10,1ft	15,2ft	20,3ft	25,4ft	30,4ft	40,6ft	50,7ft

## LINEAR DISTRIBUTION DIAGRAM

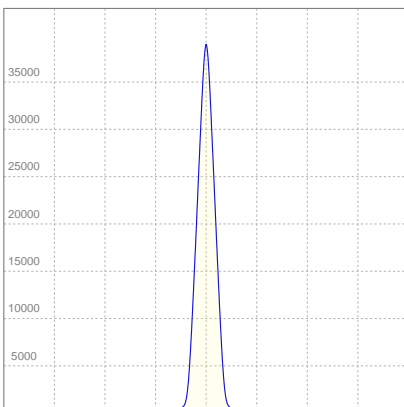

## ELECTRICAL SPECIFICATIONS

Input voltage	Input current	Input power	Effeciency
226V	0,855A	175,5W	24lm/W

## ISO CANDELA DIAGRAM

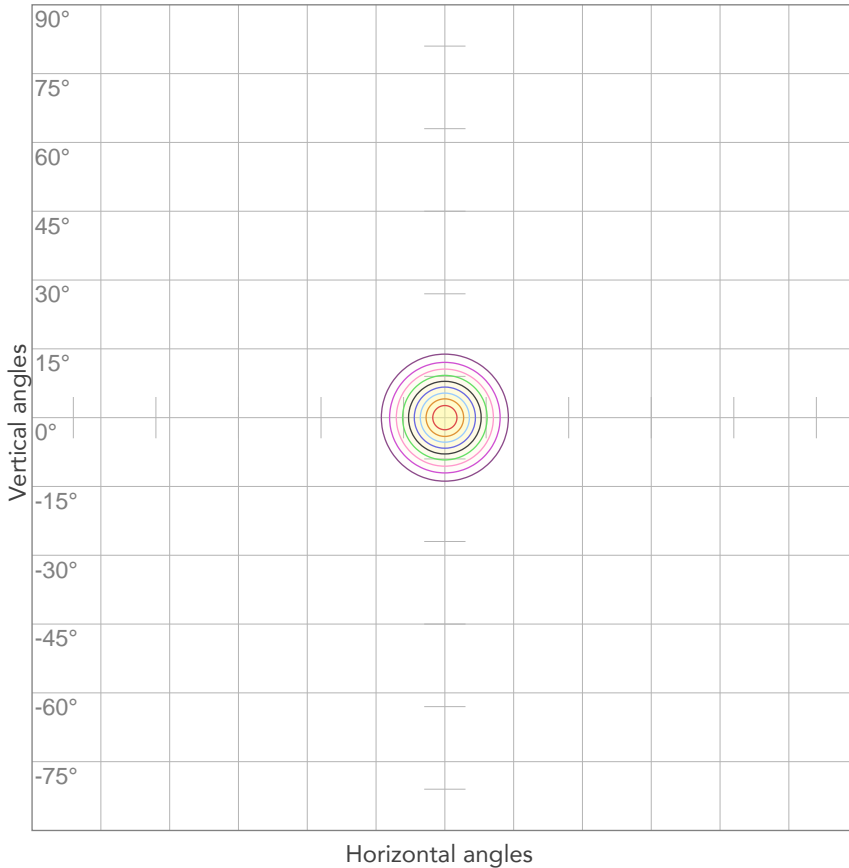

10%	3889 cd
20%	7778 cd
30%	11667 cd
40%	15556 cd
50%	19445 cd
60%	23334 cd
70%	27223 cd
80%	31112 cd

Conditions:

Number of c-planes: 2

Candela at center: 38890 cd

## ISO LUX DIAGRAM

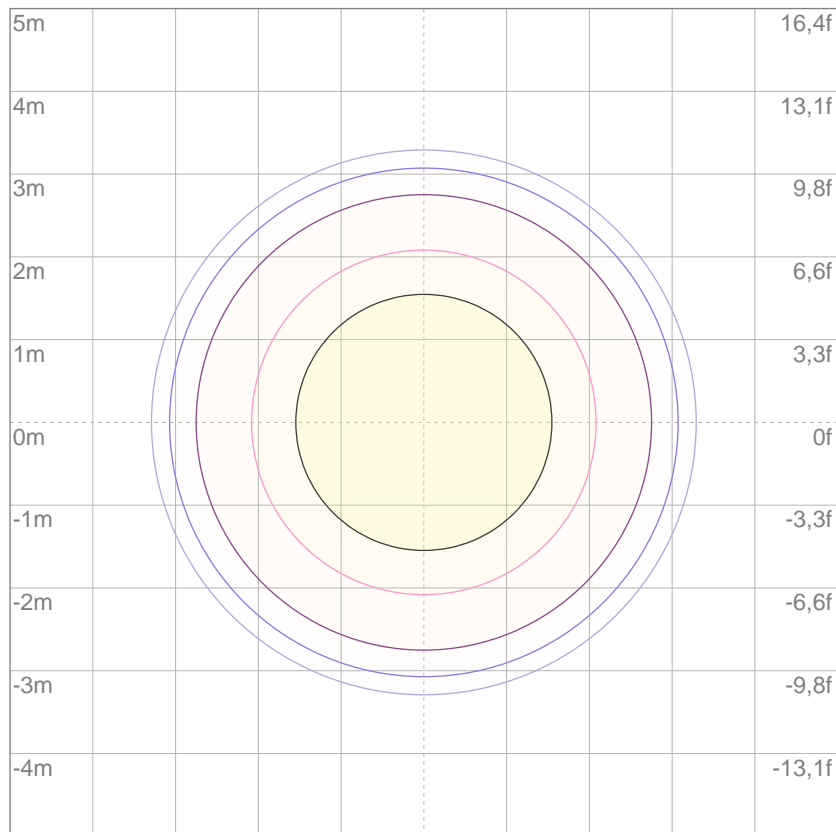

3%	11,7 lx
5%	19,4 lx
10%	38,9 lx
30%	117 lx
50%	194 lx

Conditions:

Number of c-planes: 2

Lux at center: 389 lx

*Lux distribution on a surface when lamp is mounted at 10 meters from the surface.*



Total lumen output:

7650 lm

Total candela output:

8380 cd

Light quality:

CRI: 91,1

Color temperature:

3199 K

## PRODUCT NAME:

EclipseFresnel TW

## MEASUREMENT CONDITIONS:

Beam angle:

45°

Target:

3200K

Operator:

Marco Marrocco

Date and time:

14/12/2019 12:29:54

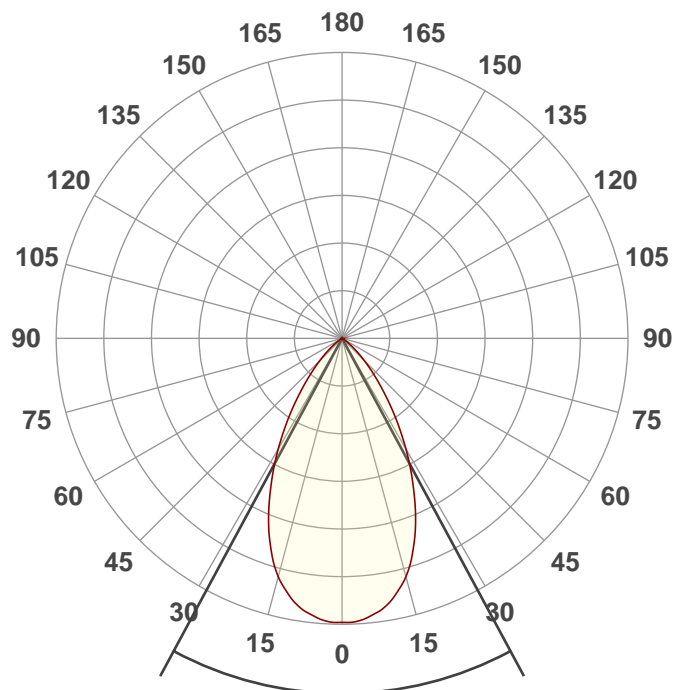

Beam angle

56,6°

Spectra

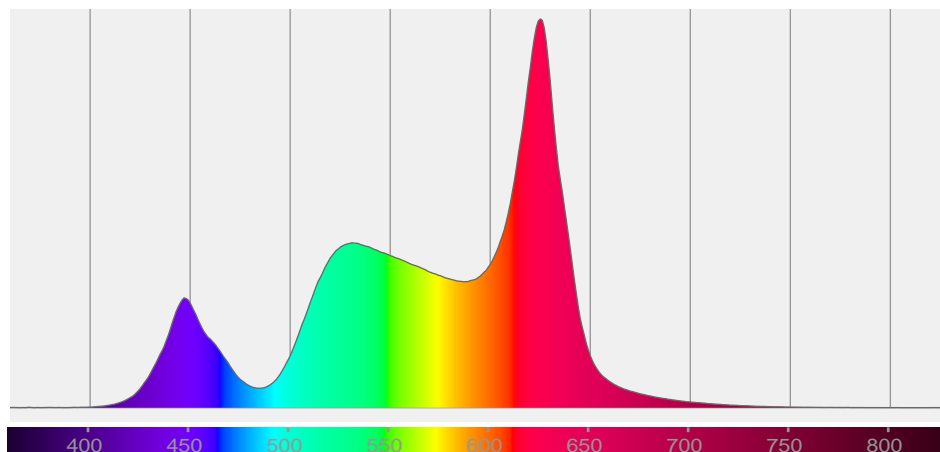

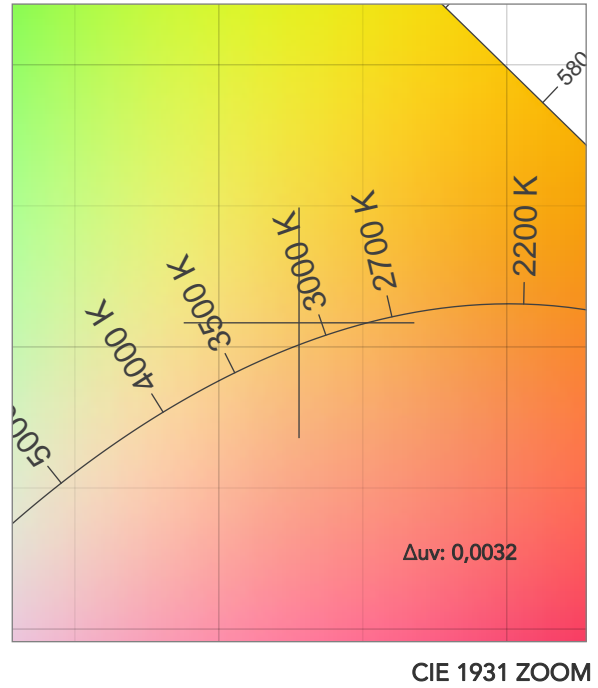
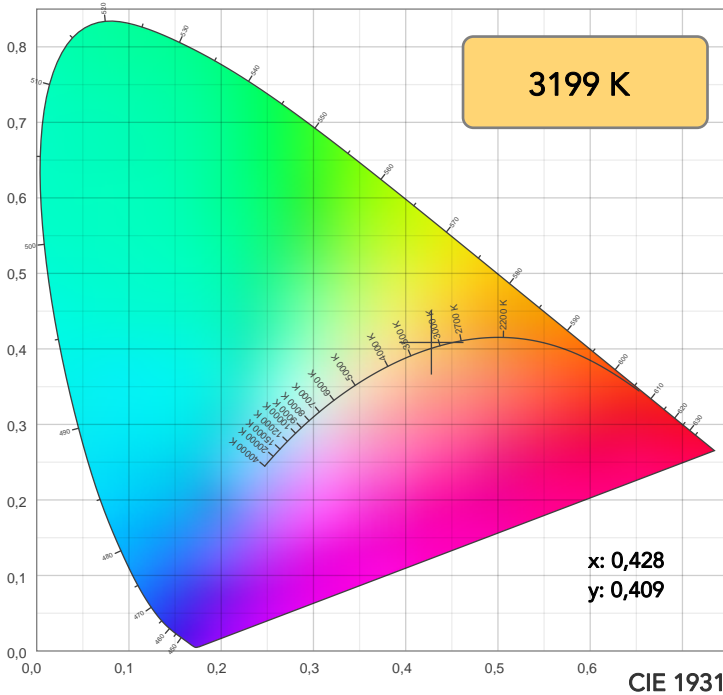

TM30: 87,4

CRI: 91,1 (R1-R8)

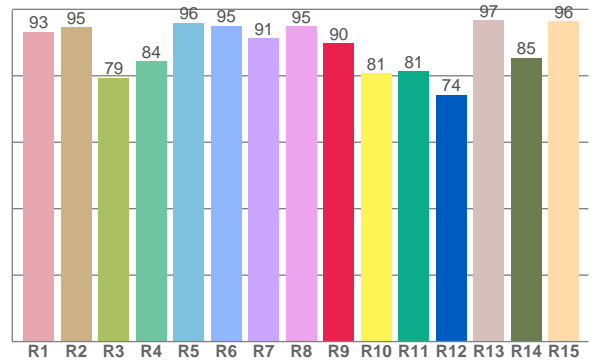
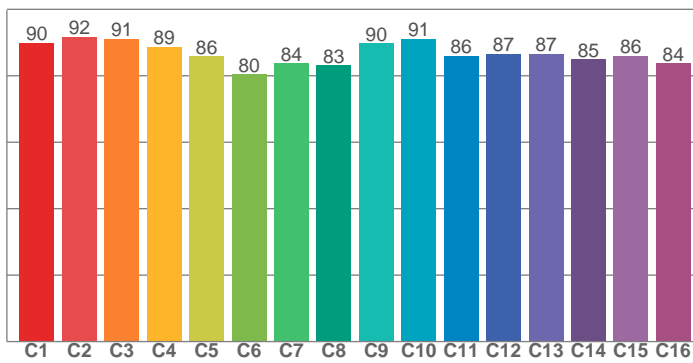

CRI R values, only R1-R8 are used to calculate final CRI value

R1	R2	R3	R4	R5	R6	R7	R8	R9	R10	R11	R12	R13	R14	R15
93,2	94,6	79,4	84,3	96,0	95,1	91,3	94,9	89,9	80,7	81,3	74,3	96,8	85,4	96,5

TM30 C values, 16 binned values out of total of 99 C values

C1	C2	C3	C4	C5	C6	C7	C8	C9	C10	C11	C12	C13	C14	C15	C16
90,0	91,8	91,1	88,7	85,9	80,4	83,8	83,1	89,7	91,1	86,0	86,6	86,5	85,0	86,0	83,8

CQS Q values

Q1	Q2	Q3	Q4	Q5	Q6	Q7	Q8	Q9	Q10	Q11	Q12	Q13	Q14	Q15
89,8	95,9	86,4	92,2	87,7	80,7	86,6	97,0	89,5	91,2	92,4	90,4	89,1	96,2	93,9

CQS: 89,6

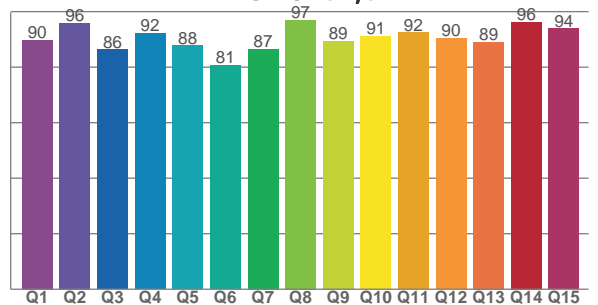

COLOR PARAMETERS

Color temperature	Color rendering index	Red component	Color fidelity	Color gamut	Color quality scale	Television lighting index	Color coordinate cie 1931	Color coordinate cie 1931	Color deviation from black body
CCT	CRI	CRI R9	TM30 Rf	TM30 Rg	CQS	TLCI	x	y	Δuv
3199 K	91,1	89,9	87,4	106,8	89,6	76	0,428	0,409	0,0032

# TM30 DETAILS

**Rf 87,4**  
Fidelity index Rf

**Rg 106,8**  
Gammut index

Hue Bin	R <sub>f</sub>	Graphic shifts (%)	
		Chroma	Hue
1	90	0%	-3%
2	92	0%	-1%
3	91	1%	3%
4	89	2%	6%
5	86	6%	7%
6	80	11%	5%
7	84	8%	-4%
8	83	7%	-7%
9	90	1%	-6%
10	91	-4%	0%
11	86	-2%	8%
12	87	5%	1%
13	87	6%	-4%
14	85	6%	-3%
15	86	5%	-3%
16	84	4%	-10%

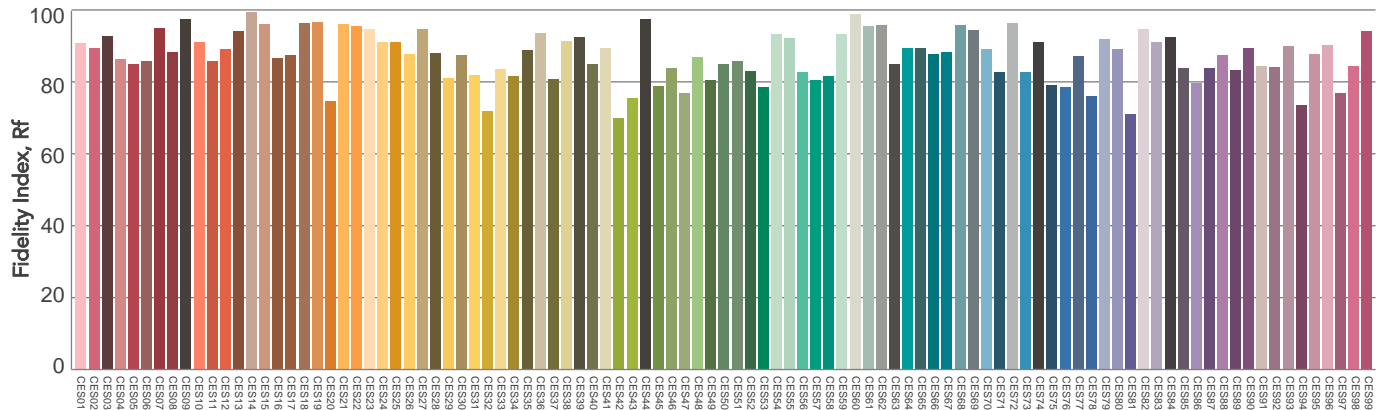
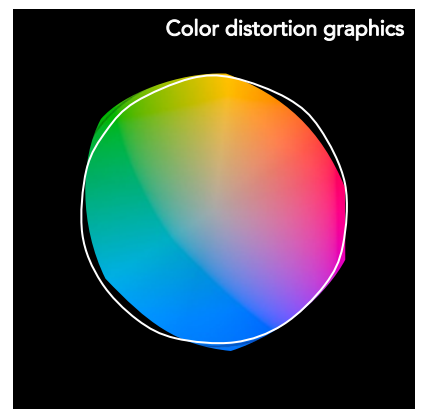
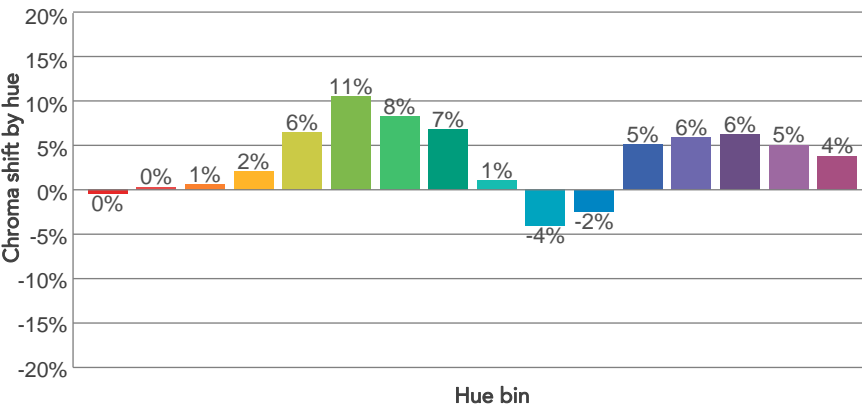
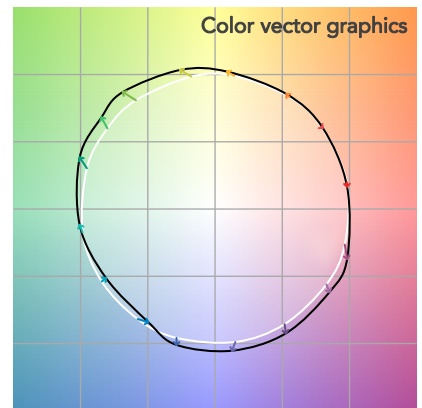
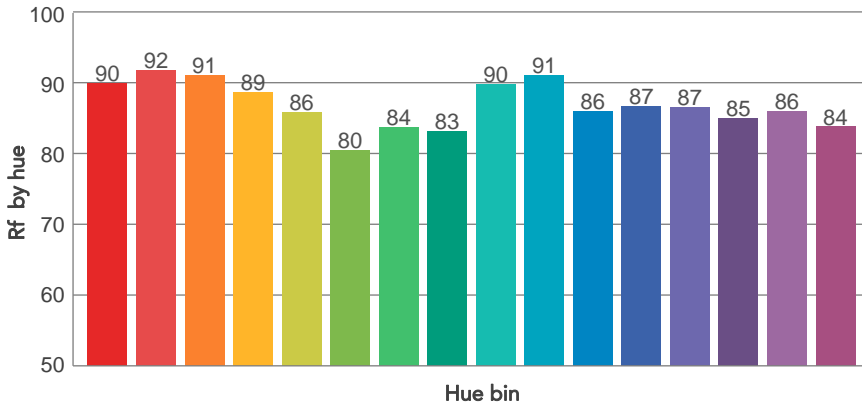
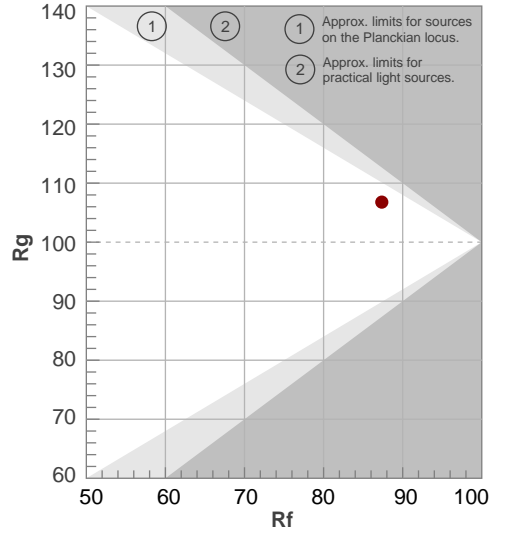

Color Evaluation Sample

# BEAM DETAILS



Beam angle 50%	Field angle 10%	Cutoff angle 2,5%	Intensity ratio in 120° cone	Intensity ratio in 90° cone
56,6°	91,6°	107,9°	99,5%	93,7%

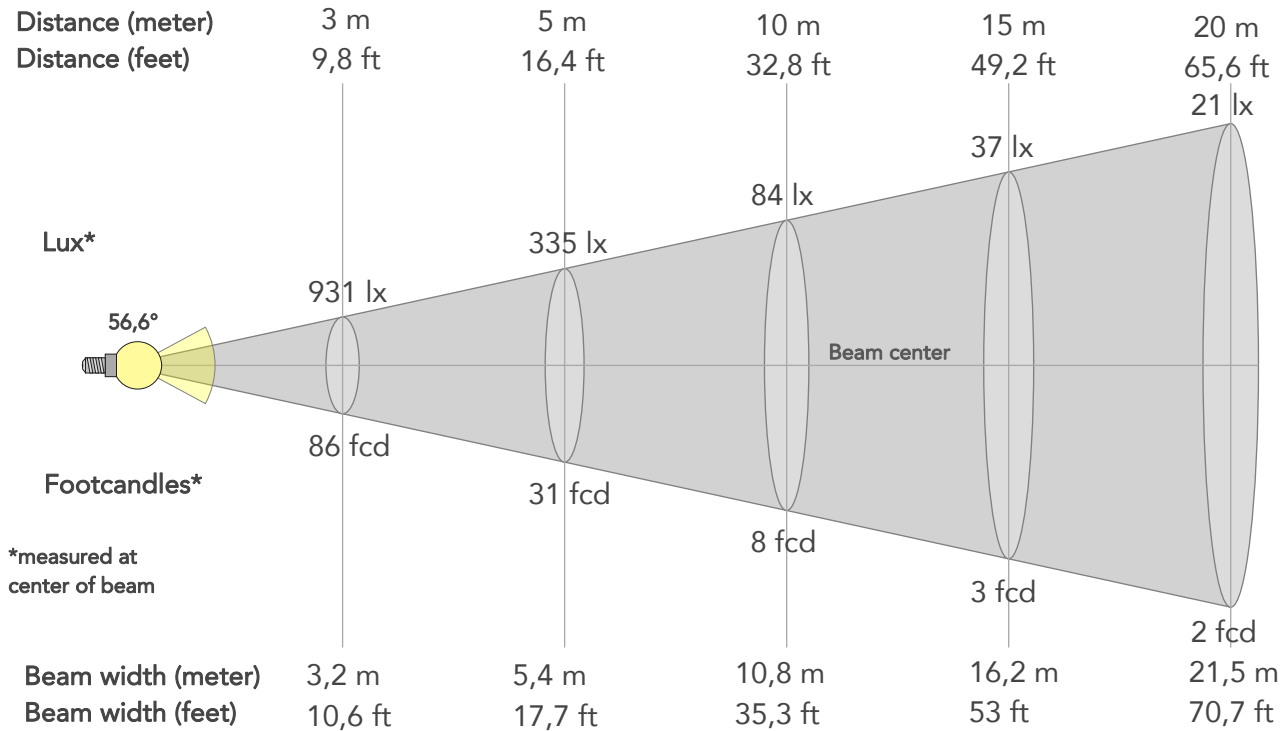

## BEAM INTENSITIES AND WIDTHS

Distance	1m	2m	3m	4m	5m	7,5m	10m	15m	20m	25m	30m	40m	50m
Distance	3,3ft	6,6ft	9,8ft	13,1ft	16,4ft	24,6ft	32,8ft	49,2ft	65,6ft	82ft	98,4ft	131,2ft	164ft
Lux	8375lx	2094lx	931lx	523lx	335lx	149lx	84lx	37lx	21lx	13lx	9lx	5lx	3lx
Footcand.	778fcd	195fcd	86fcd	49fcd	31fcd	14fcd	8fcd	3fcd	2fcd	1fcd	1fcd	0fcd	0fcd
Beam wid.	1,1m	2,2m	3,2m	4,3m	5,4m	8,1m	10,8m	16,2m	21,5m	26,9m	32,3m	43,1m	53,9m
Beam wid.	3,6ft	7,1ft	10,6ft	14,1ft	17,7ft	26,5ft	35,3ft	53ft	70,7ft	88,3ft	106ft	141,3ft	176,6ft

## LINEAR DISTRIBUTION DIAGRAM

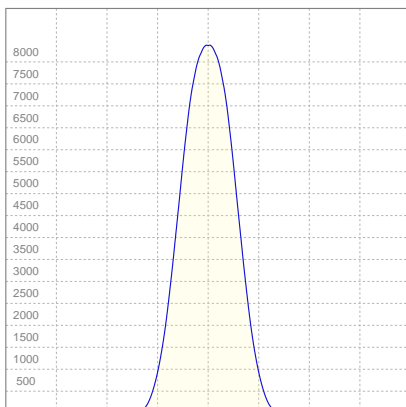

## ELECTRICAL SPECIFICATIONS

Input voltage	Input current	Input power	Effeciency
226V	0,874A	179,9W	43lm/W

## ISO CANDELA DIAGRAM

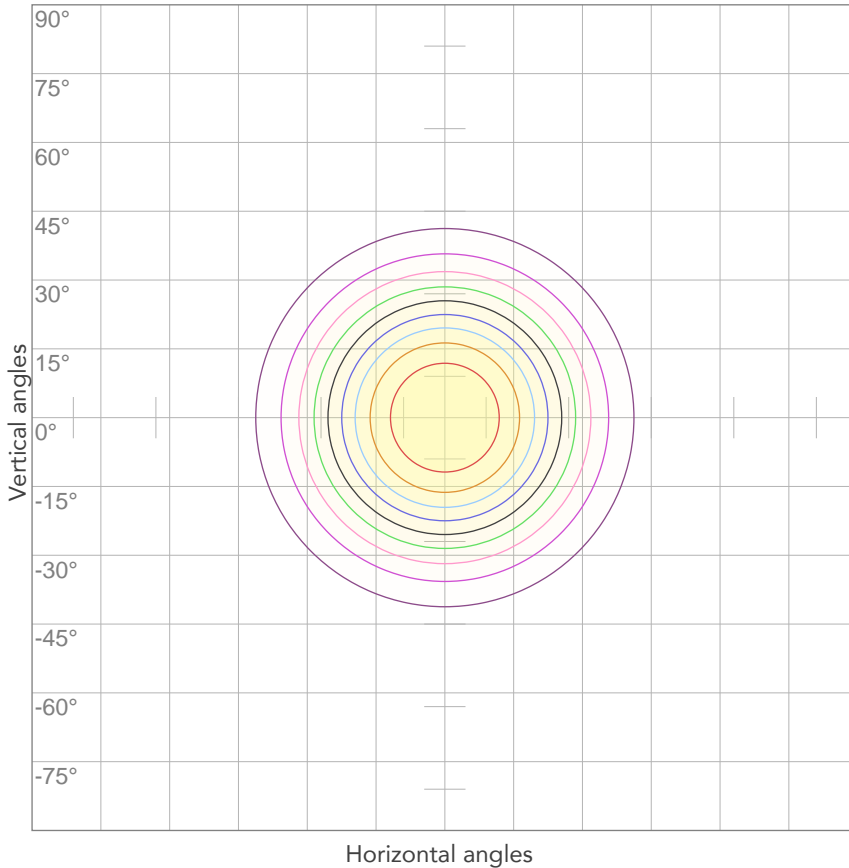

10%	837 cd
20%	1675 cd
30%	2512 cd
40%	3350 cd
50%	4187 cd
60%	5025 cd
70%	5862 cd
80%	6700 cd

**Conditions:**

Number of c-planes: 2

Candela at center: 8375 cd

## ISO LUX DIAGRAM

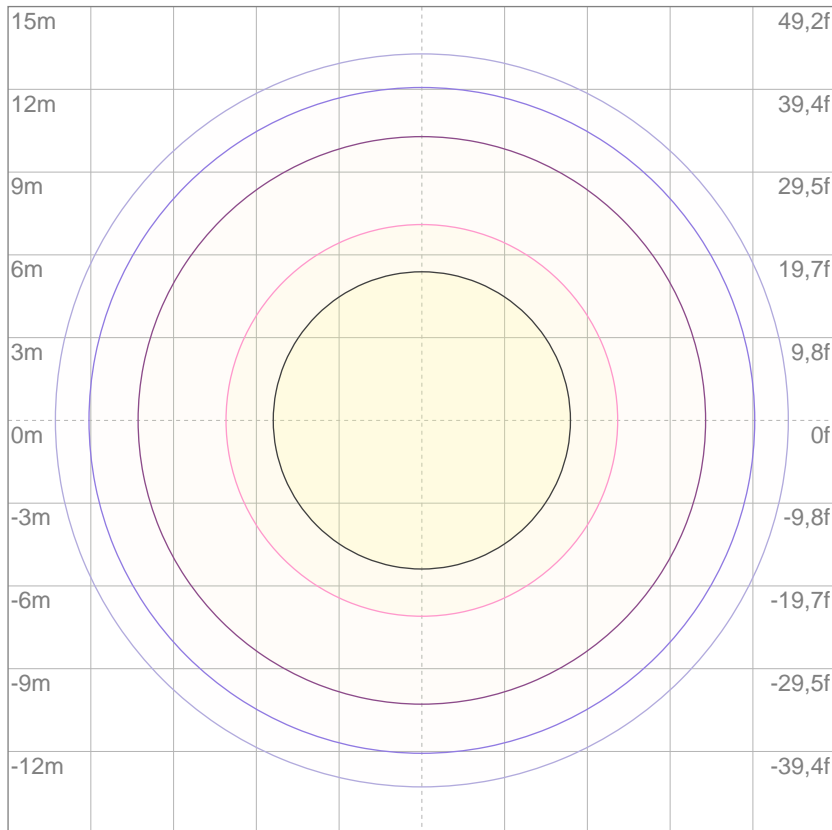

3%	2,51 lx
5%	4,19 lx
10%	8,37 lx
30%	25,1 lx
50%	41,9 lx

**Conditions:**

Number of c-planes: 2

Lux at center: 83,7 lx

*Lux distribution on a surface when lamp is mounted at 10 meters from the surface.*

Mounting height: 10 meters (33 feet)



Total lumen output:

7306 lm

Total candela output:

23324 cd

Light quality:

CRI: 91,3

Color temperature:

3201 K

**PRODUCT NAME:**

EclipseFresnel TW

**MEASUREMENT CONDITIONS:**

Beam angle:

30°

Target:

3200K

Operator:

Marco Marrocco

Date and time:

14/12/2019 11:54:24

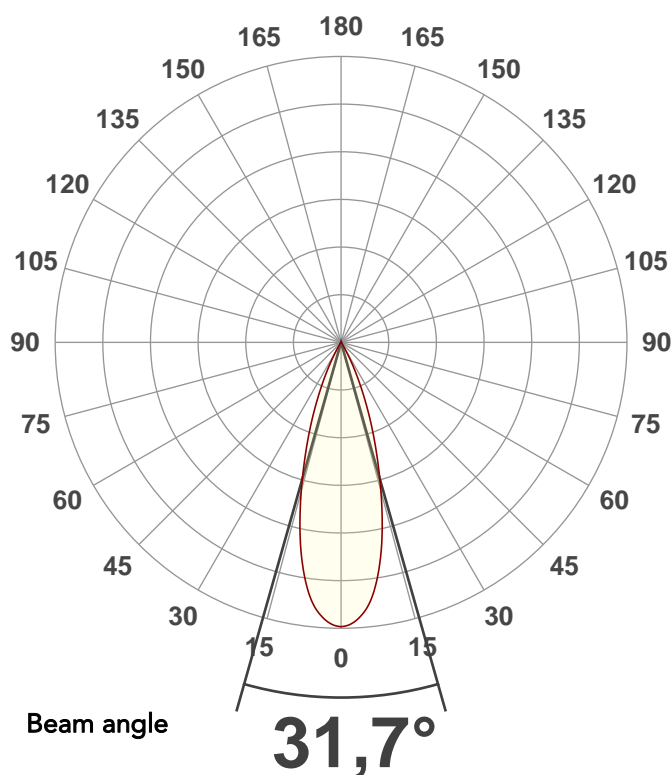

Spectra

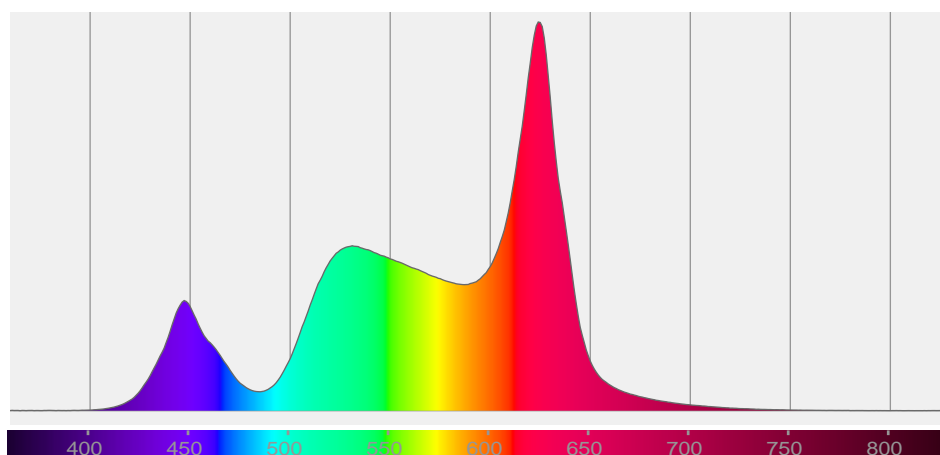



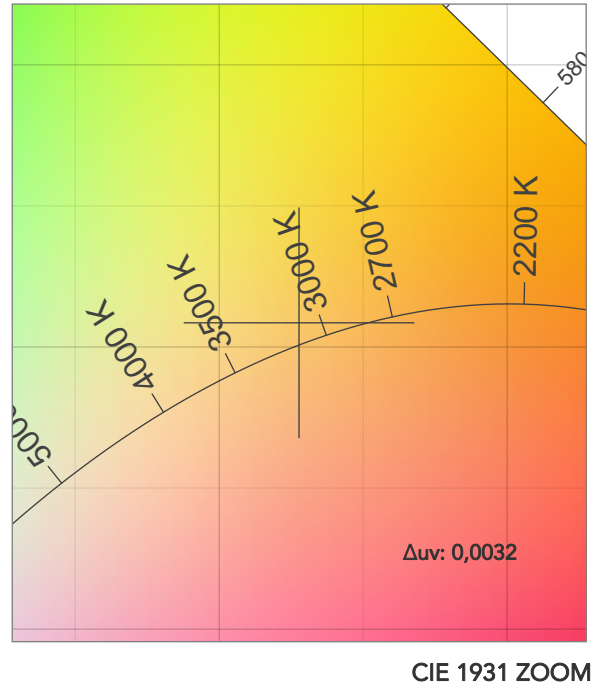
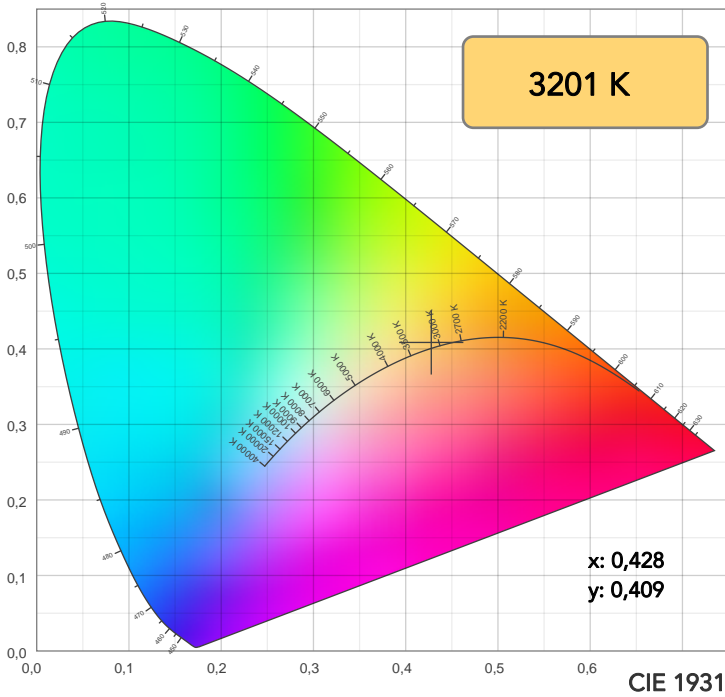

TM30: 87,1

CRI: 91,3 (R1-R8)

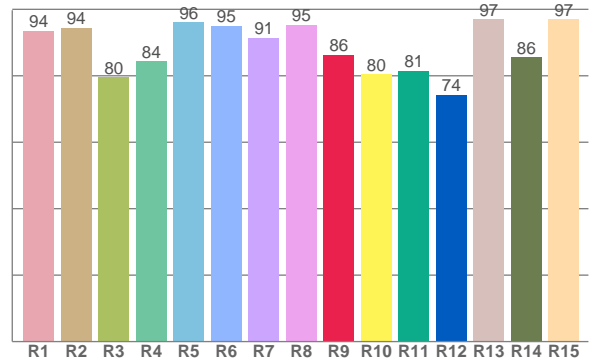
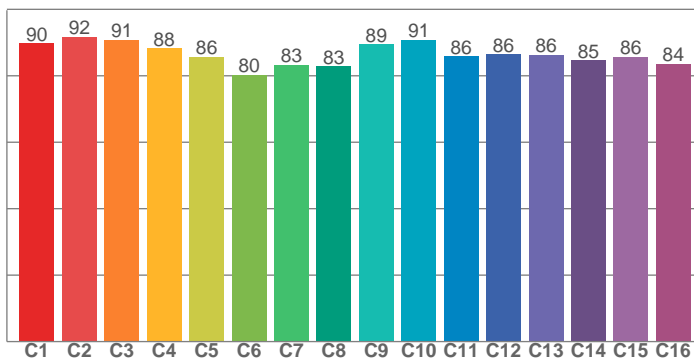

CRI R values, only R1-R8 are used to calculate final CRI value

R1	R2	R3	R4	R5	R6	R7	R8	R9	R10	R11	R12	R13	R14	R15
93,6	94,5	79,7	84,5	96,1	95,0	91,5	95,4	86,4	80,4	81,5	74,3	97,1	85,6	96,9

TM30 C values, 16 binned values out of total of 99 C values

C1	C2	C3	C4	C5	C6	C7	C8	C9	C10	C11	C12	C13	C14	C15	C16
89,7	91,7	90,7	88,2	85,6	80,2	83,3	82,8	89,4	90,7	85,9	86,4	86,3	84,6	85,7	83,6

CQS Q values

Q1	Q2	Q3	Q4	Q5	Q6	Q7	Q8	Q9	Q10	Q11	Q12	Q13	Q14	Q15
88,9	95,9	86,4	92,0	87,4	80,4	86,4	97,1	89,6	91,1	92,4	90,6	89,4	95,9	93,0

CQS: 89,4

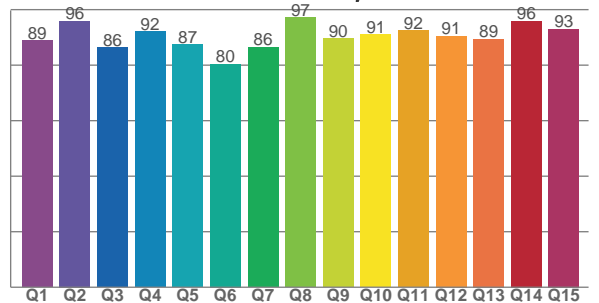

COLOR PARAMETERS

Color temperature	Color rendering index	Red component	Color fidelity	Color gamut	Color quality scale	Television lighting index	Color coordinate cie 1931	Color coordinate cie 1931	Color deviation from black body
CCT	CRI	CRI R9	TM30 Rf	TM30 Rg	CQS	TLCI	x	y	Δuv
3201 K	91,3	86,4	87,1	106,7	89,4	75	0,428	0,409	0,0032

# TM30 DETAILS

**Rf 87,1**  
Fidelity index Rf

**Rg 106,7**  
Gammut index

Hue Bin	R <sub>f</sub>	Graphic shifts (%)	
		Chroma	Hue
1	90	-1%	-3%
2	92	0%	-1%
3	91	1%	3%
4	88	2%	6%
5	86	7%	7%
6	80	11%	5%
7	83	8%	-5%
8	83	7%	-7%
9	89	1%	-6%
10	91	-4%	-1%
11	86	-3%	8%
12	86	5%	1%
13	86	6%	-4%
14	85	6%	-3%
15	86	5%	-4%
16	84	3%	-10%

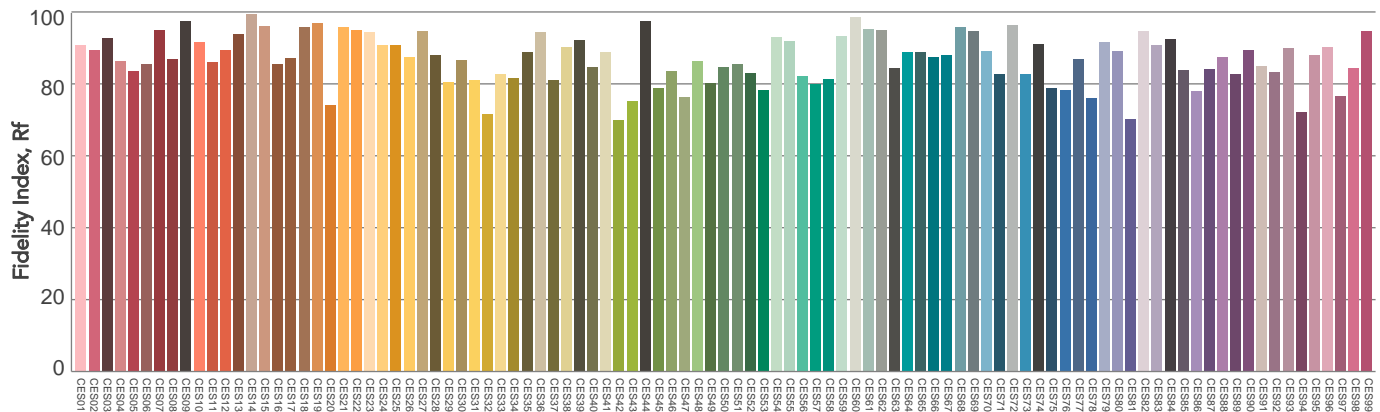
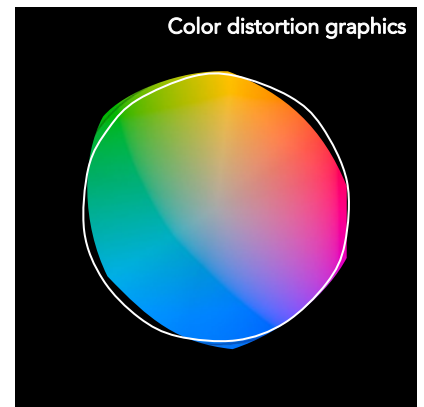
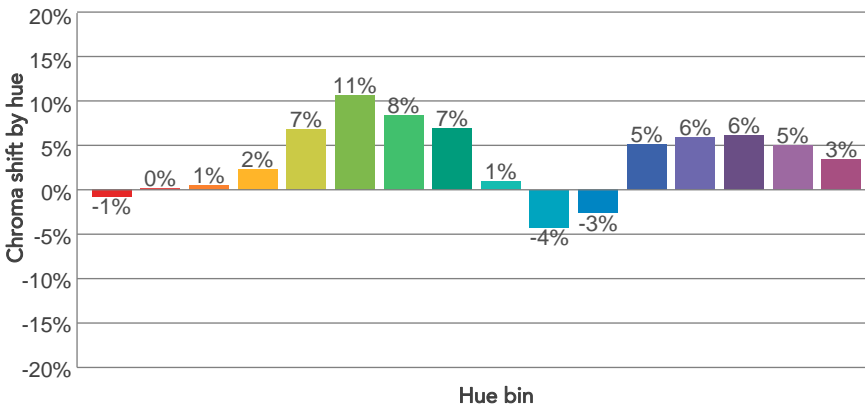
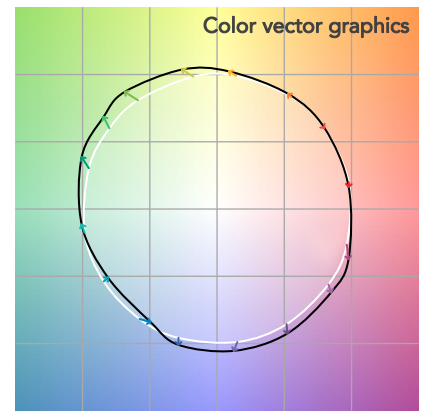
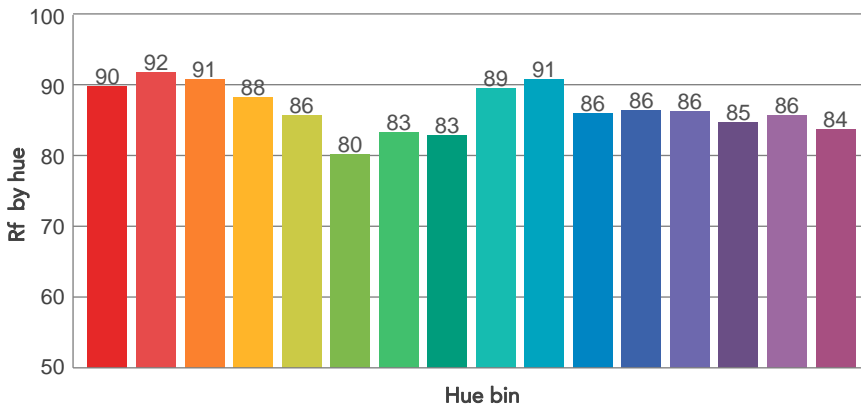
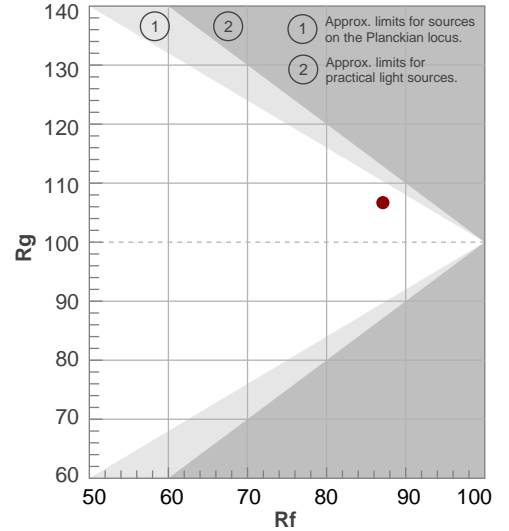

# BEAM DETAILS



Beam angle 50%	Field angle 10%	Cutoff angle 2,5%	Intensity ratio in 120° cone	Intensity ratio in 90° cone
31,7°	53,1°	62,1°	99,4%	98,3%

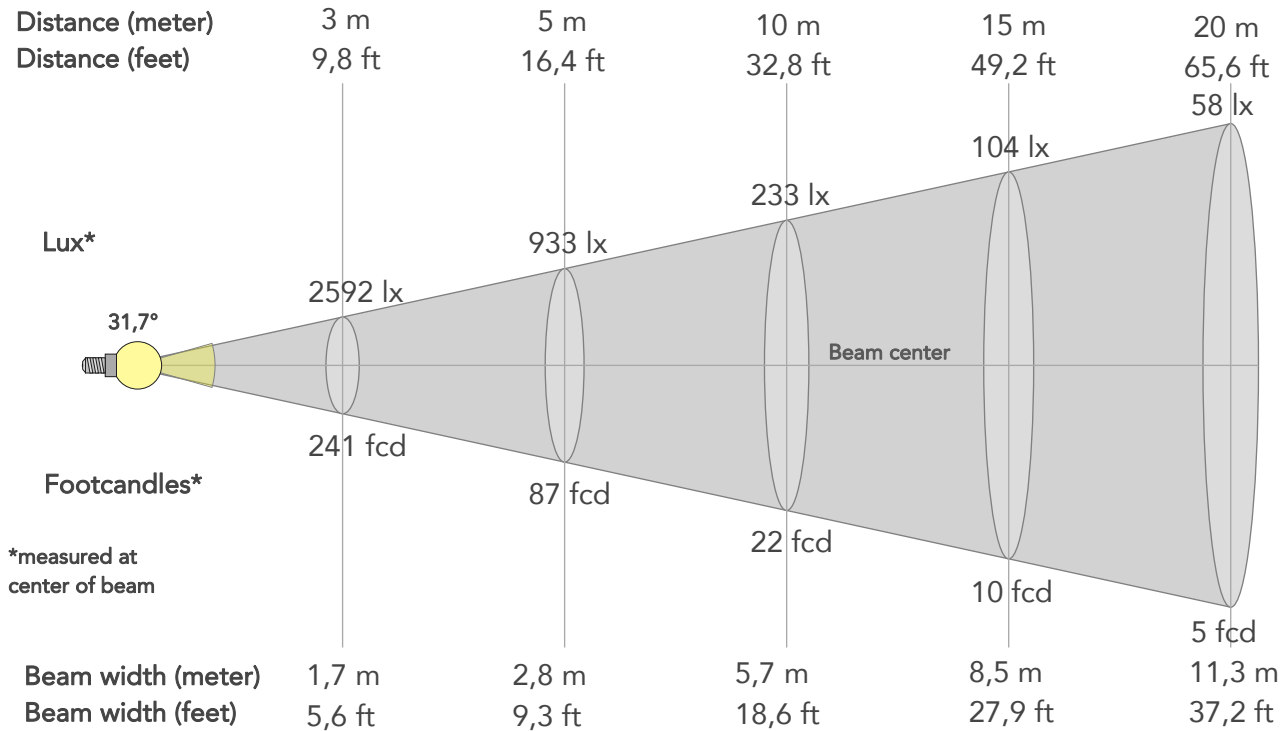

## BEAM INTENSITIES AND WIDTHS

Distance	1m	2m	3m	4m	5m	7,5m	10m	15m	20m	25m	30m	40m	50m
Distance	3,3ft	6,6ft	9,8ft	13,1ft	16,4ft	24,6ft	32,8ft	49,2ft	65,6ft	82ft	98,4ft	131,2ft	164ft
Lux	23324lx	5831lx	2592lx	1458lx	933lx	415lx	233lx	104lx	58lx	37lx	26lx	15lx	9lx
Footcand.	2167fcd	542fcd	241fcd	135fcd	87fcd	39fcd	22fcd	10fcd	5fcd	3fcd	2fcd	1fcd	1fcd
Beam wid.	0,6m	1,1m	1,7m	2,3m	2,8m	4,3m	5,7m	8,5m	11,3m	14,2m	17m	22,7m	28,4m
Beam wid.	1,9ft	3,7ft	5,6ft	7,4ft	9,3ft	14ft	18,6ft	27,9ft	37,2ft	46,5ft	55,8ft	74,4ft	93ft

## LINEAR DISTRIBUTION DIAGRAM

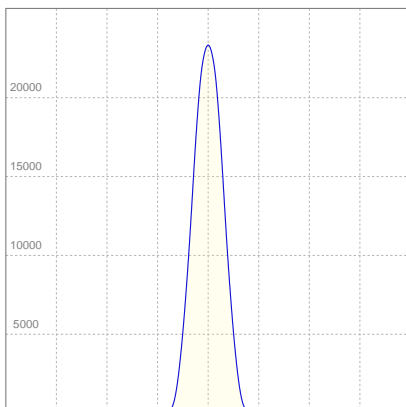

## ELECTRICAL SPECIFICATIONS

Input voltage	Input current	Input power	Effeciency
225V	0,919A	189,5W	39lm/W

## ISO CANDELA DIAGRAM

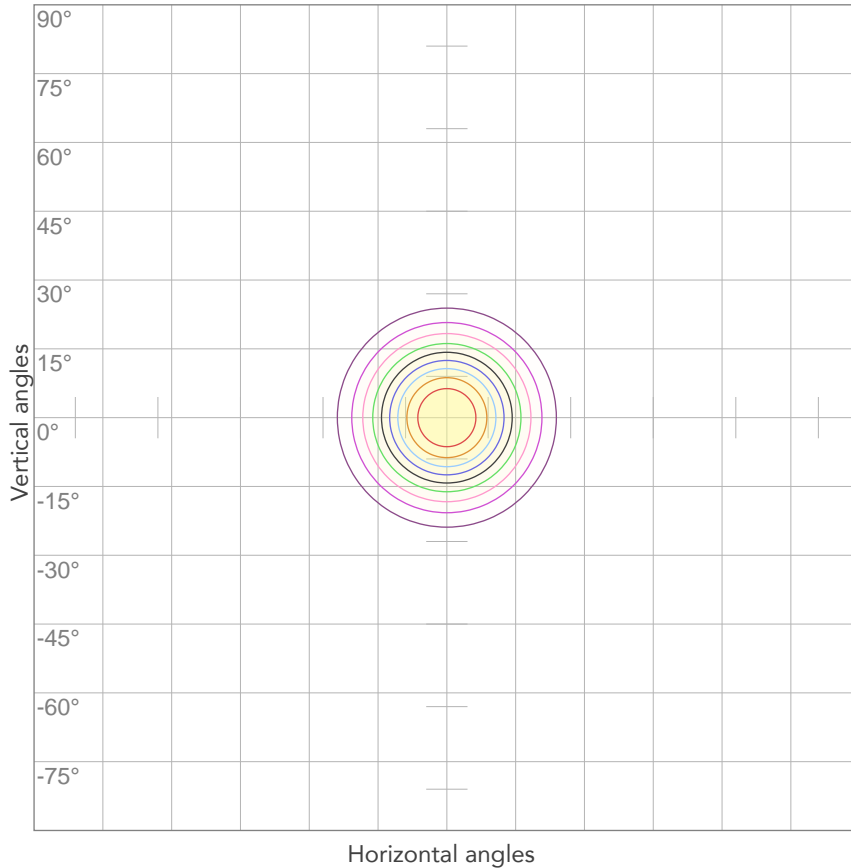

10%	2332 cd
20%	4665 cd
30%	6997 cd
40%	9330 cd
50%	11662 cd
60%	13995 cd
70%	16327 cd
80%	18660 cd

Conditions:

Number of c-planes: 2

Candela at center: 23324 cd

## ISO LUX DIAGRAM

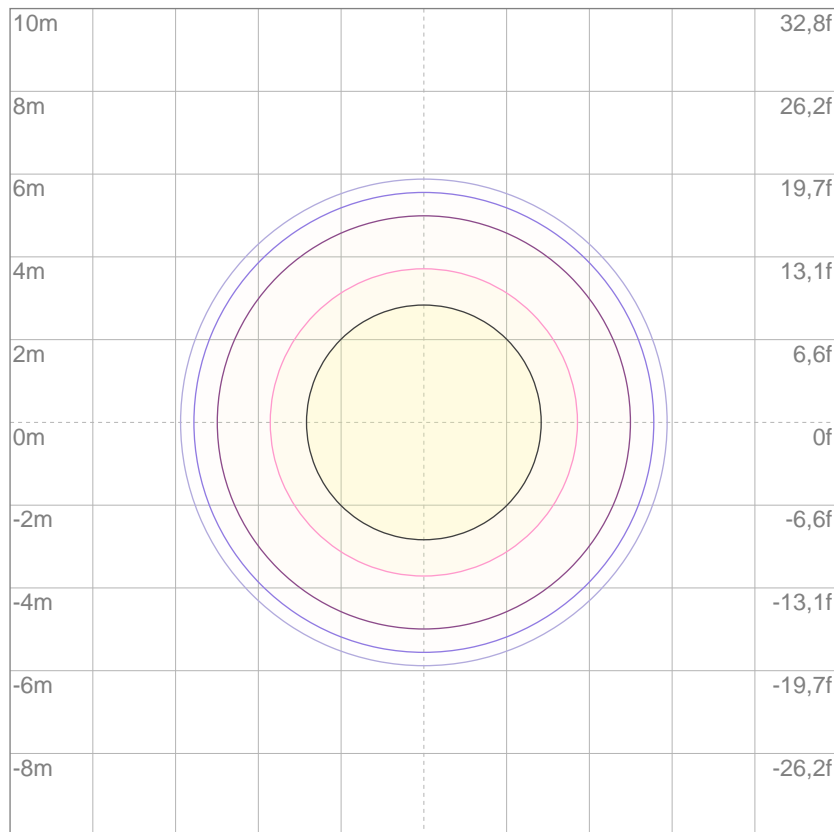

3%	7,00 lx
5%	11,7 lx
10%	23,3 lx
30%	70,0 lx
50%	117 lx

Conditions:

Number of c-planes: 2

Lux at center: 233 lx

*Lux distribution on a surface when lamp is mounted at 10 meters from the surface.*

Mounting height: 10 meters (33 feet)



Total lumen output:

4578 lm

Total candela output:

41014 cd

Light quality:

CRI: 91,4

Color temperature:

3200 K

## PRODUCT NAME:

EclipseFresnel TW

## MEASUREMENT CONDITIONS:

Beam angle:

15°

Target:

3200K

Operator:

Marco Marrocco

Date and time:

14/12/2019 11:14:24

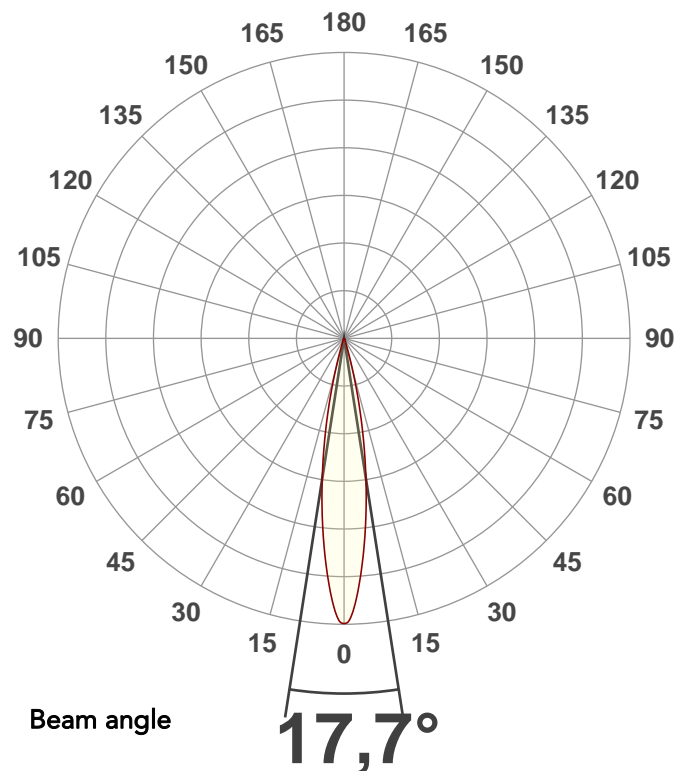

Spectra

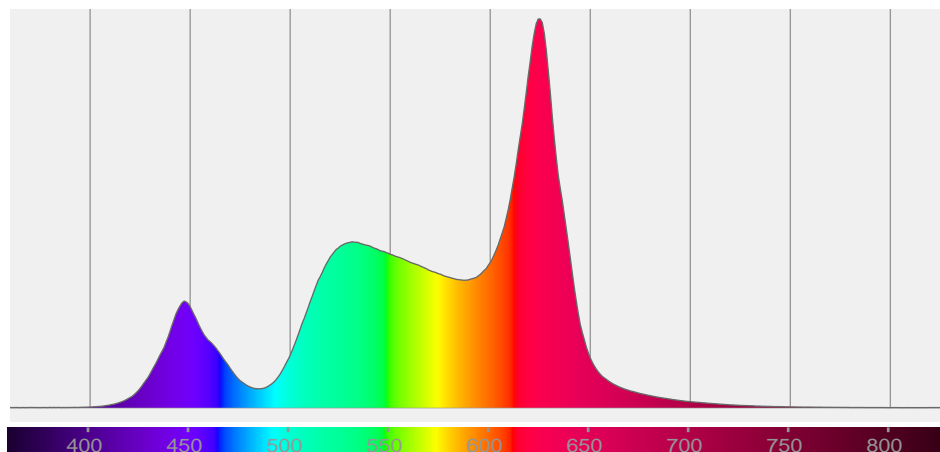

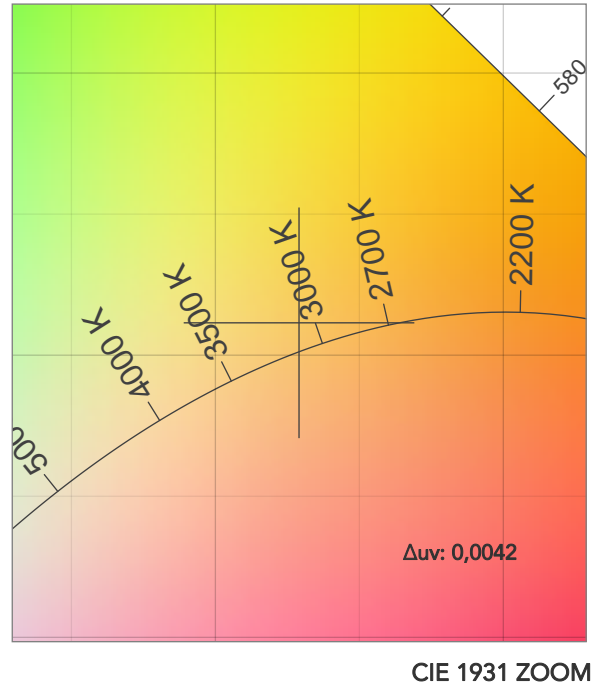
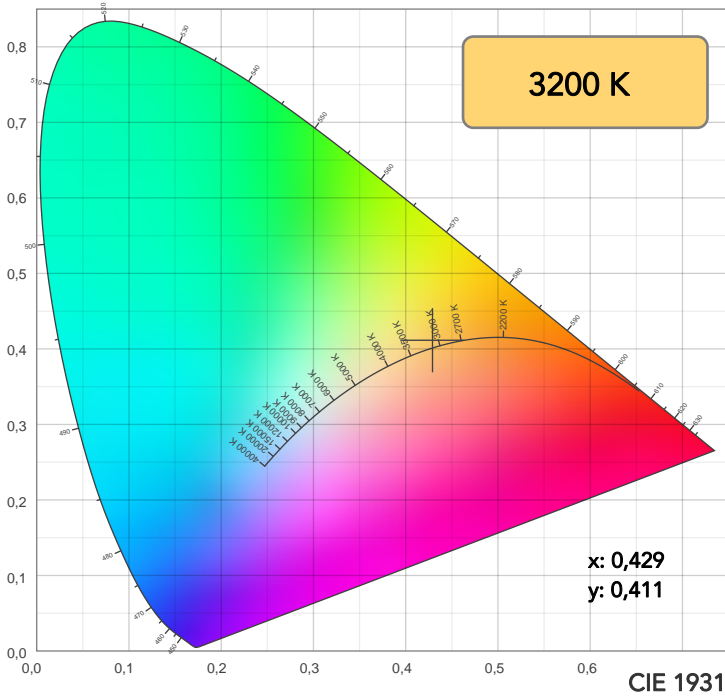

TM30: 87,4

CRI: 91,4 (R1-R8)

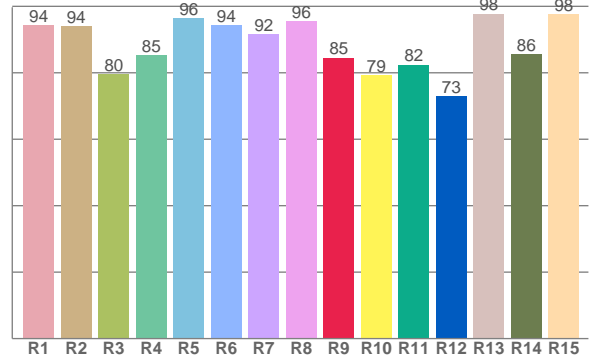
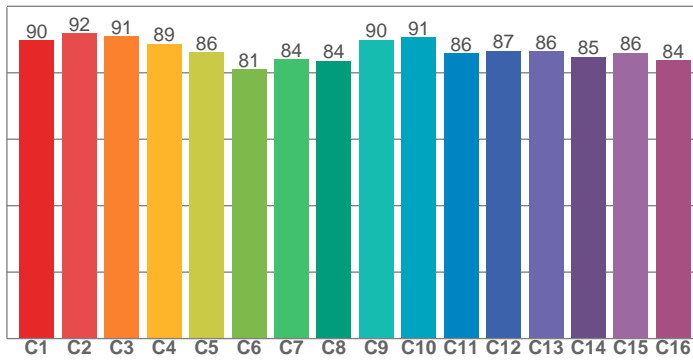

CRI R values, only R1-R8 are used to calculate final CRI value

R1	R2	R3	R4	R5	R6	R7	R8	R9	R10	R11	R12	R13	R14	R15
94,4	93,9	79,6	85,2	96,4	94,4	91,6	95,6	84,6	79,3	82,4	72,9	97,8	85,6	97,6

TM30 C values, 16 binned values out of total of 99 C values

C1	C2	C3	C4	C5	C6	C7	C8	C9	C10	C11	C12	C13	C14	C15	C16
89,8	91,9	91,0	88,7	86,1	81,0	84,1	83,5	89,8	90,6	85,8	86,6	86,4	84,8	85,9	83,7

CQS Q values

Q1	Q2	Q3	Q4	Q5	Q6	Q7	Q8	Q9	Q10	Q11	Q12	Q13	Q14	Q15
88,9	95,7	86,7	91,9	87,5	80,9	86,9	96,9	89,6	91,3	91,0	89,8	89,1	95,9	92,6

CQS: 89,4

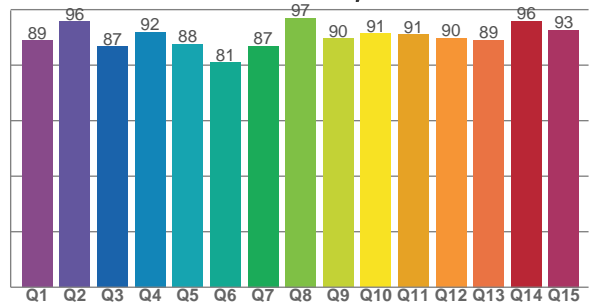

COLOR PARAMETERS

Color temperature	Color rendering index	Red component	Color fidelity	Color gamut	Color quality scale	Television lighting index	Color coordinate cie 1931	Color coordinate cie 1931	Color deviation from black body
CCT	CRI	CRI R9	TM30 Rf	TM30 Rg	CQS	TLCI	x	y	Δuv
3200 K	91,4	84,6	87,4	106,1	89,4	75	0,429	0,411	0,0042

# TM30 DETAILS

**Rf 87,4**  
Fidelity index Rf

**Rg 106,1**  
Gammut index

Hue Bin	R <sub>f</sub>	Graphic shifts (%)	
		Chroma	Hue
1	90	-1%	-3%
2	92	0%	-1%
3	91	0%	3%
4	89	2%	6%
5	86	6%	7%
6	81	10%	5%
7	84	8%	-5%
8	84	7%	-7%
9	90	1%	-6%
10	91	-4%	0%
11	86	-3%	8%
12	87	5%	1%
13	86	6%	-4%
14	85	6%	-4%
15	86	5%	-4%
16	84	3%	-10%

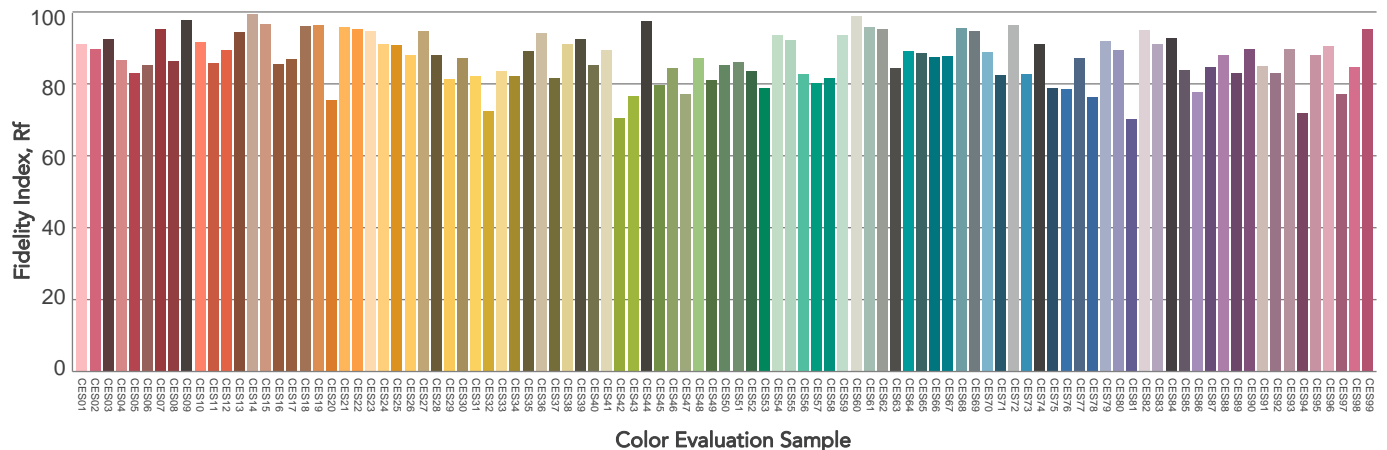
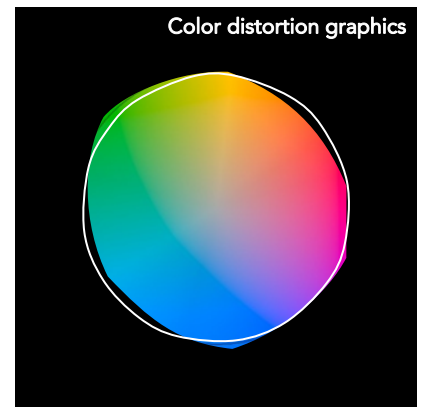
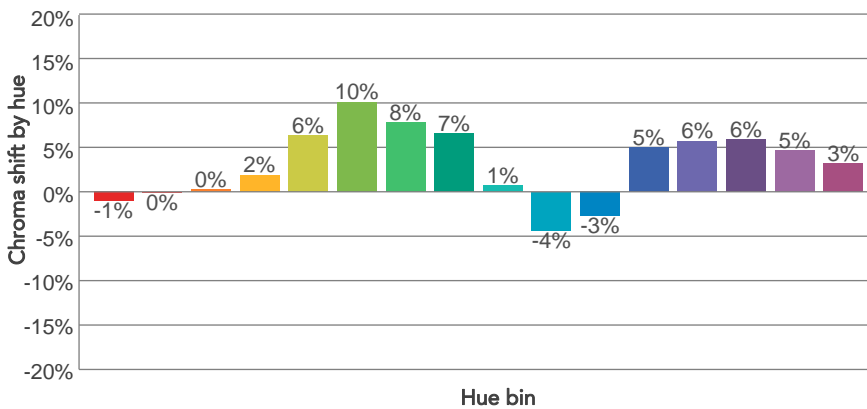
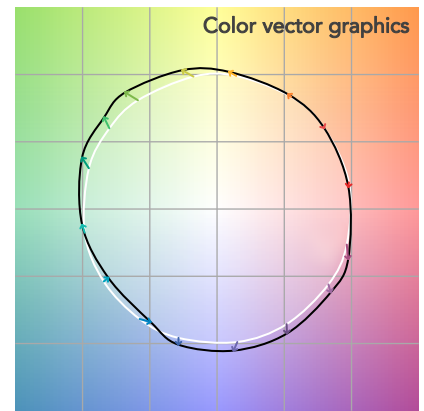
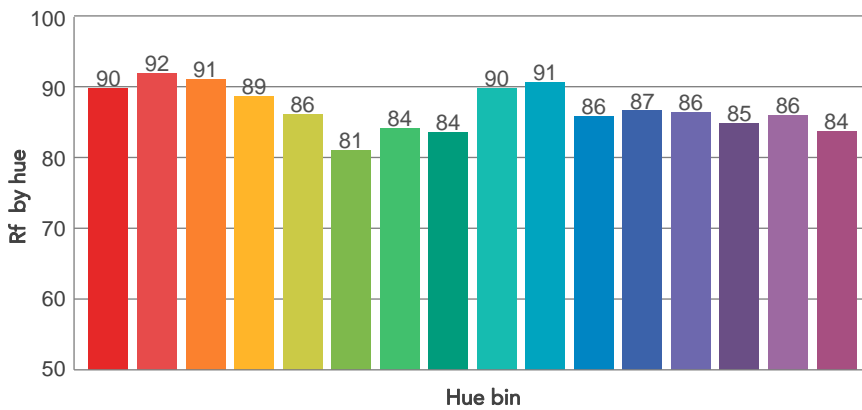
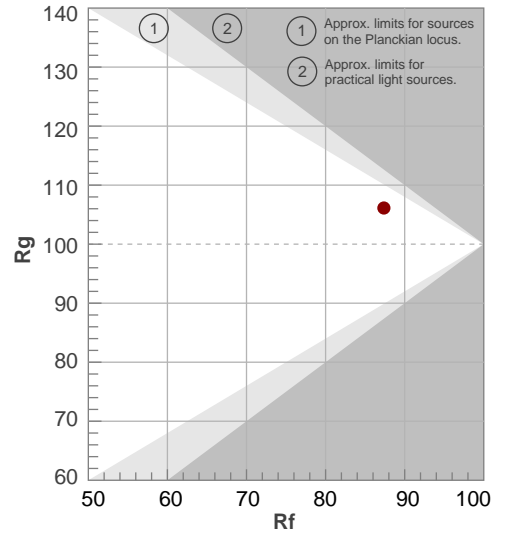

# BEAM DETAILS



Beam angle 50%	Field angle 10%	Cutoff angle 2,5%	Intensity ratio in 120° cone	Intensity ratio in 90° cone
17,7°	30,9°	38°	99,2%	97,7%

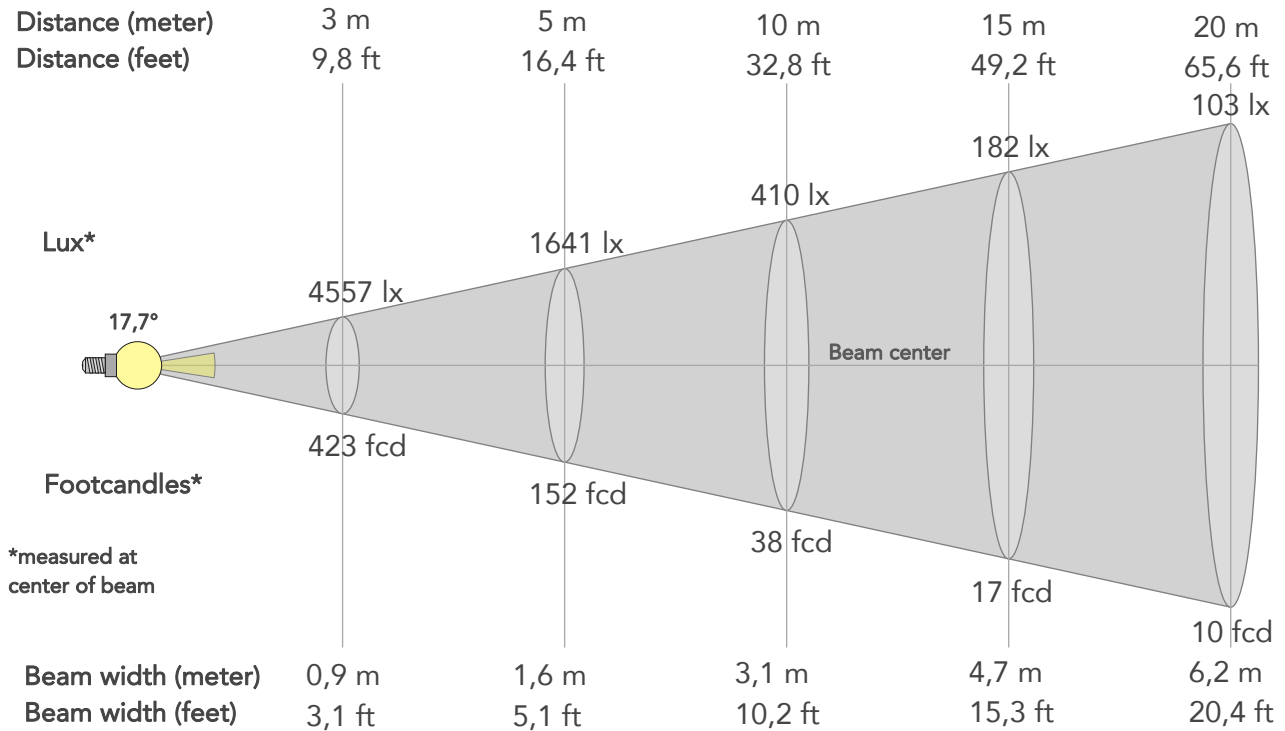

## BEAM INTENSITIES AND WIDTHS

Distance	1m	2m	3m	4m	5m	7,5m	10m	15m	20m	25m	30m	40m	50m
Distance	3,3ft	6,6ft	9,8ft	13,1ft	16,4ft	24,6ft	32,8ft	49,2ft	65,6ft	82ft	98,4ft	131,2ft	164ft
Lux	41014lx	10254lx	4557lx	2563lx	1641lx	729lx	410lx	182lx	103lx	66lx	46lx	26lx	16lx
Footcand.	3810fcd	953fcd	423fcd	238fcd	152fcd	68fcd	38fcd	17fcd	10fcd	6fcd	4fcd	2fcd	2fcd
Beam wid.	0,3m	0,6m	0,9m	1,2m	1,6m	2,3m	3,1m	4,7m	6,2m	7,8m	9,3m	12,5m	15,6m
Beam wid.	1ft	2,1ft	3,1ft	4,1ft	5,1ft	7,7ft	10,2ft	15,3ft	20,4ft	25,5ft	30,6ft	40,8ft	51,1ft

## LINEAR DISTRIBUTION DIAGRAM

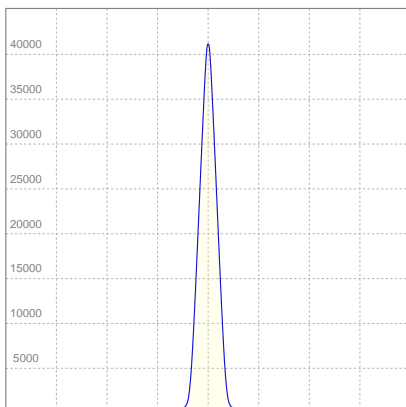

## ELECTRICAL SPECIFICATIONS

Input voltage	Input current	Input power	Efficiency
227V	0,907A	187,6W	24lm/W



## ISO CANDELA DIAGRAM

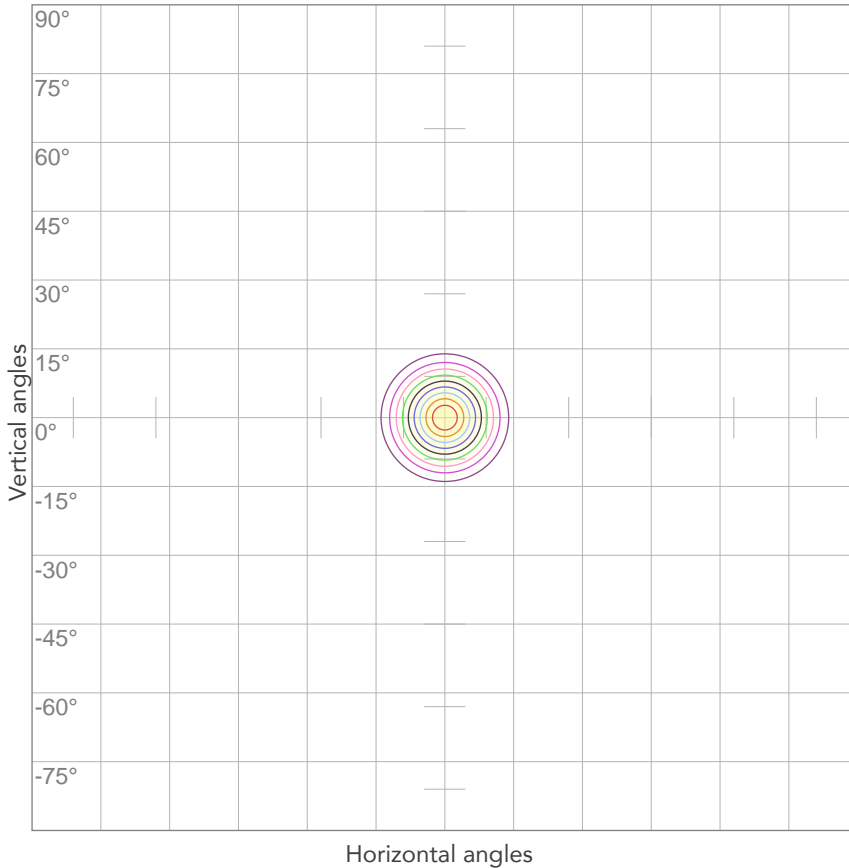

10%	4101 cd
20%	8203 cd
30%	12304 cd
40%	16406 cd
50%	20507 cd
60%	24608 cd
70%	28710 cd
80%	32811 cd

Conditions:

Number of c-planes: 2

Candela at center: 41014 cd

## ISO LUX DIAGRAM

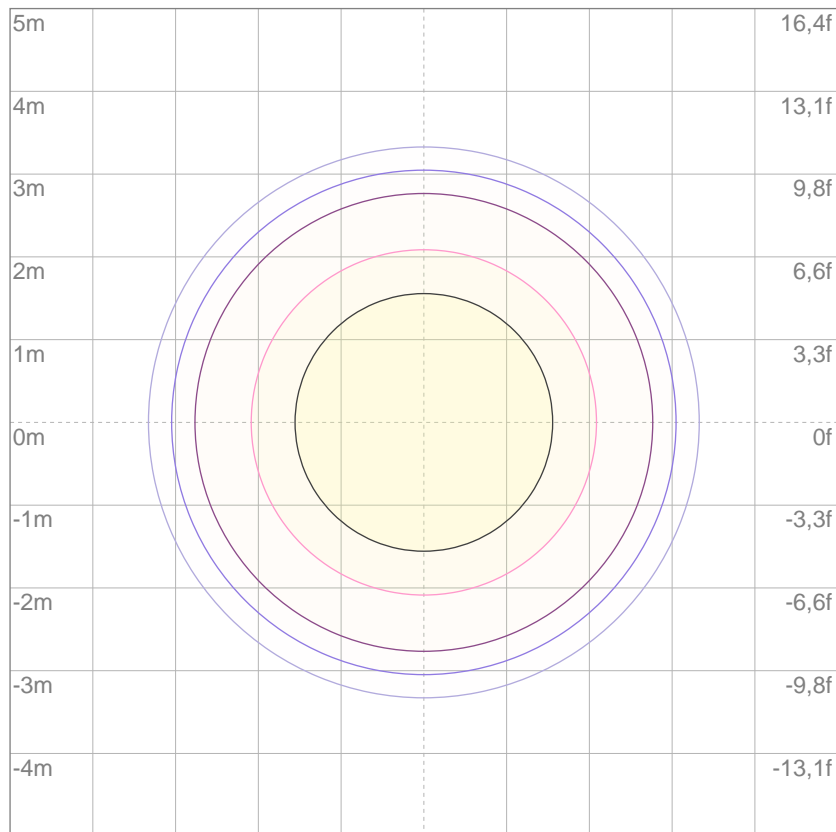

3%	12,3 lx
5%	20,5 lx
10%	41,0 lx
30%	123 lx
50%	205 lx

Conditions:

Number of c-planes: 2

Lux at center: 410 lx

*Lux distribution on a surface when lamp is mounted at 10 meters from the surface.*



Total lumen output:

7791 lm

Total candela output:

8515 cd

Light quality:

CRI: 91,0

Color temperature:

4022 K

## PRODUCT NAME:

EclipseFresnel TW

## MEASUREMENT CONDITIONS:

Beam angle:

45°

Target:

4000K

Operator:

Marco Marrocco

Date and time:

14/12/2019 10:48:57

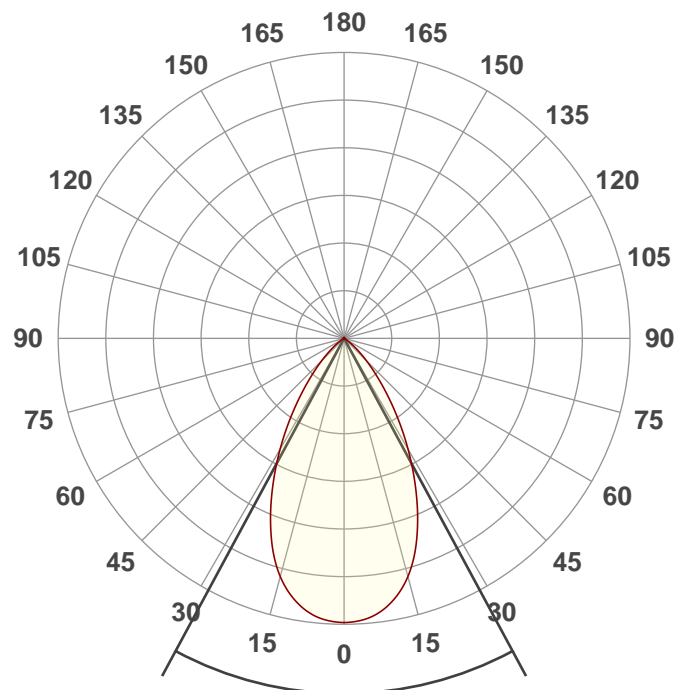

Beam angle

**56,6°**

Spectra

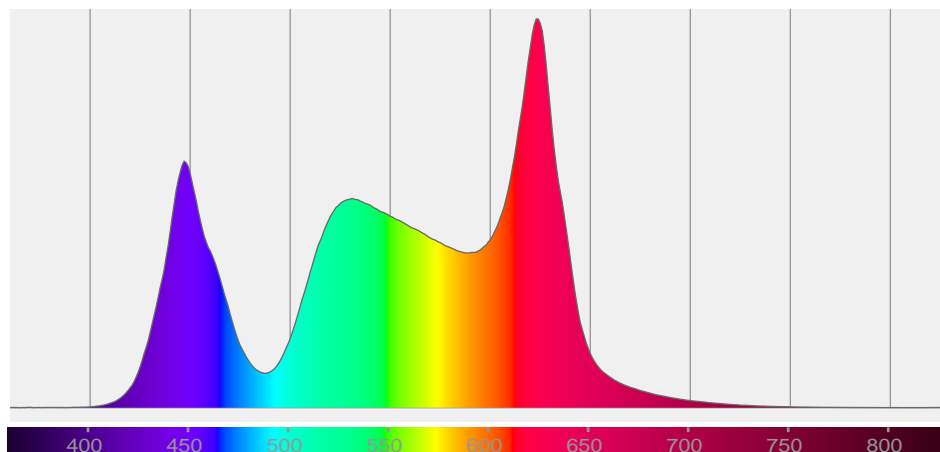

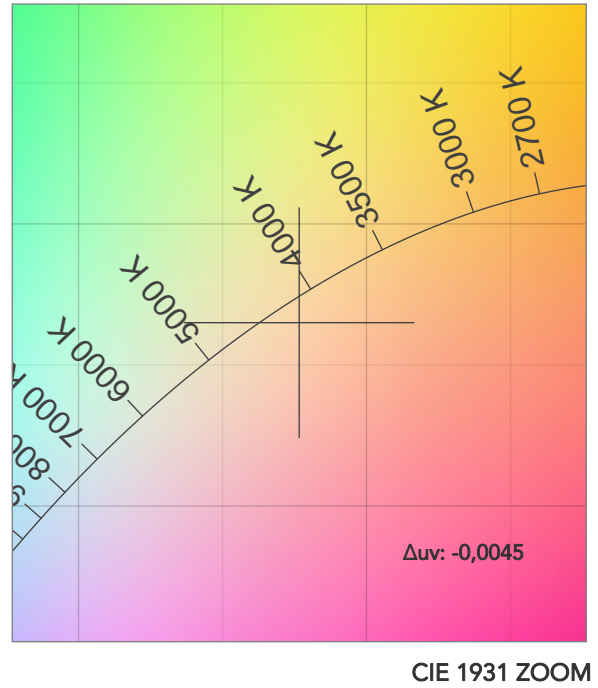
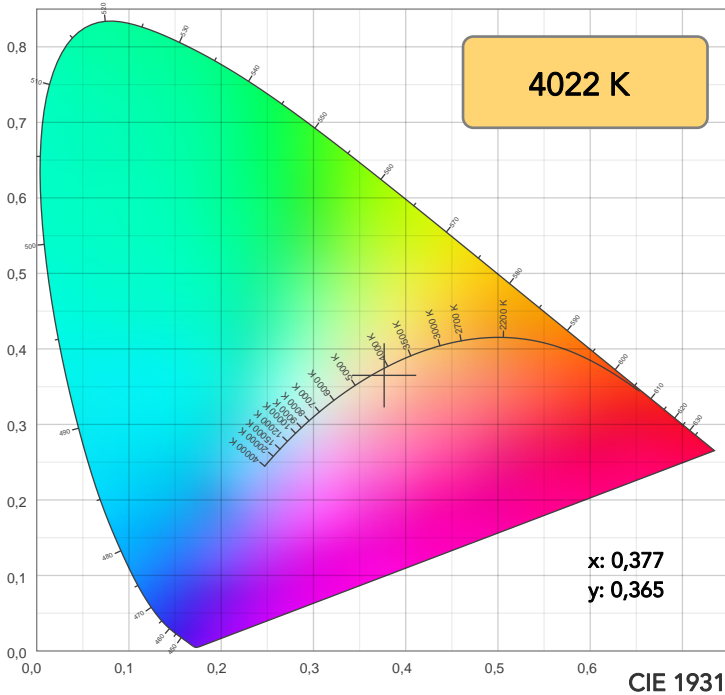

TM30: 85,1

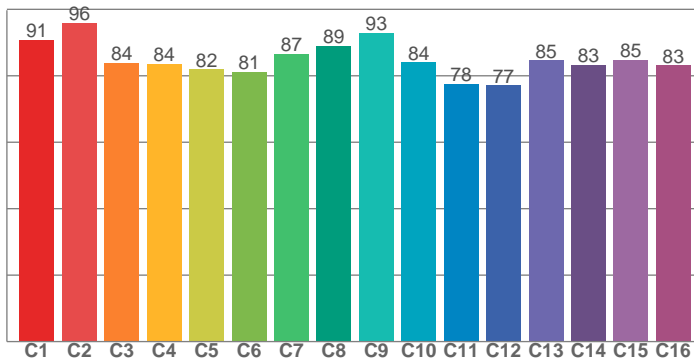

CRI: 91,0 (R1-R8)

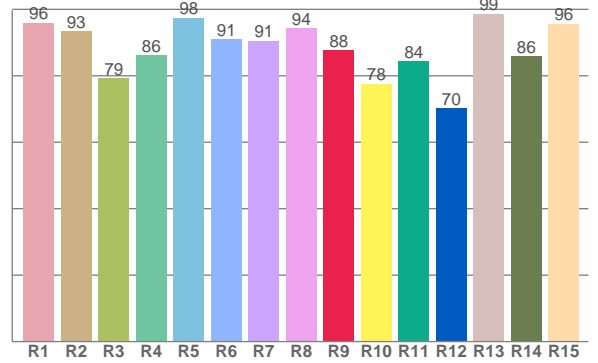

CQS: 88,9

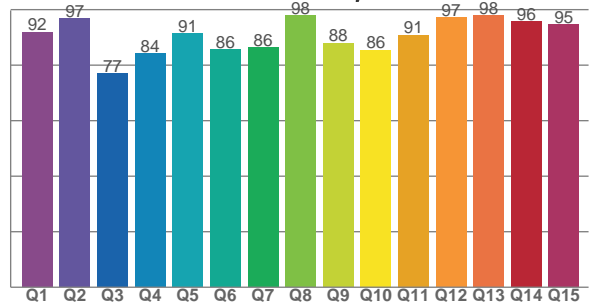

CRI R values, only R1-R8 are used to calculate final CRI value

R1	R2	R3	R4	R5	R6	R7	R8	R9	R10	R11	R12	R13	R14	R15
96,0	93,4	79,3	86,1	97,5	90,9	90,5	94,2	87,7	77,6	84,4	70,1	98,7	85,8	95,7

TM30 C values, 16 binned values out of total of 99 C values

C1	C2	C3	C4	C5	C6	C7	C8	C9	C10	C11	C12	C13	C14	C15	C16
90,8	95,9	83,9	83,5	81,9	81,1	86,6	89,0	93,0	84,0	77,6	77,1	84,6	83,4	84,7	83,1

CQS Q values

Q1	Q2	Q3	Q4	Q5	Q6	Q7	Q8	Q9	Q10	Q11	Q12	Q13	Q14	Q15
91,8	96,8	77,0	84,1	91,3	85,6	86,4	97,9	87,9	85,5	90,8	97,2	97,8	95,7	94,6

COLOR PARAMETERS

Color temperature	Color rendering index	Red component	Color fidelity	Color gamut	Color quality scale	Television lighting index	Color coordinate cie 1931	Color coordinate cie 1931	Color deviation from black body
CCT	CRI	CRI R9	TM30 Rf	TM30 Rg	CQS	TLCI	x	y	Δuv
4022 K	91,0	87,7	85,1	106,8	88,9	75	0,377	0,365	-0,0045

# TM30 DETAILS

**Rf 85,1**  
Fidelity index Rf

**Rg 106,8**  
Gammut index

Hue Bin	R <sub>f</sub>	Graphic shifts (%)	
		Chroma	Hue
1	91	-2%	-2%
2	96	0%	0%
3	84	0%	7%
4	84	3%	9%
5	82	7%	8%
6	81	11%	4%
7	87	7%	-4%
8	89	3%	-4%
9	93	-1%	-3%
10	84	-6%	6%
11	78	0%	13%
12	77	5%	10%
13	85	9%	0%
14	83	9%	8%
15	85	7%	-6%
16	83	5%	-8%

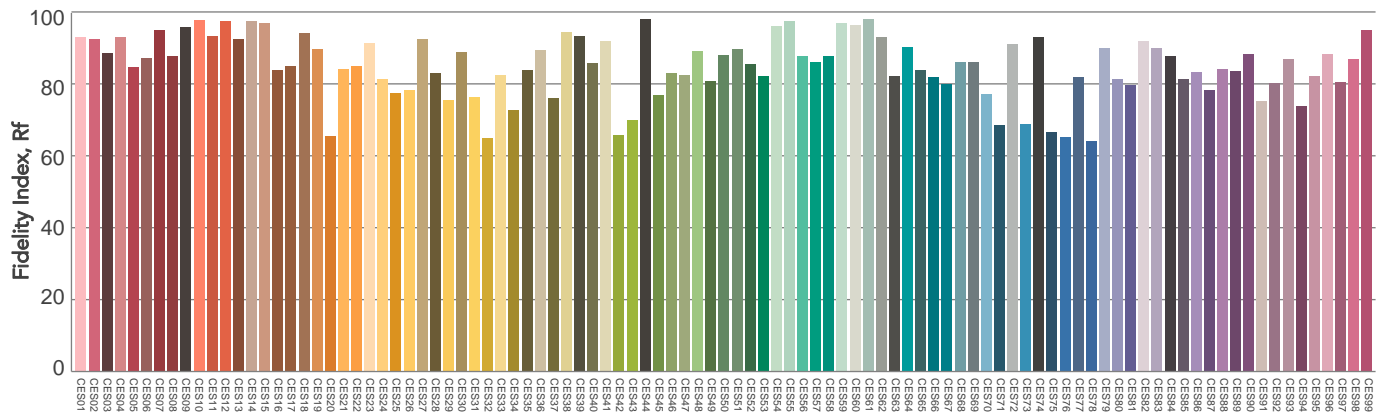
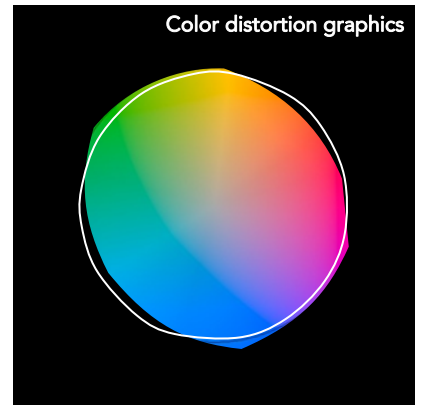
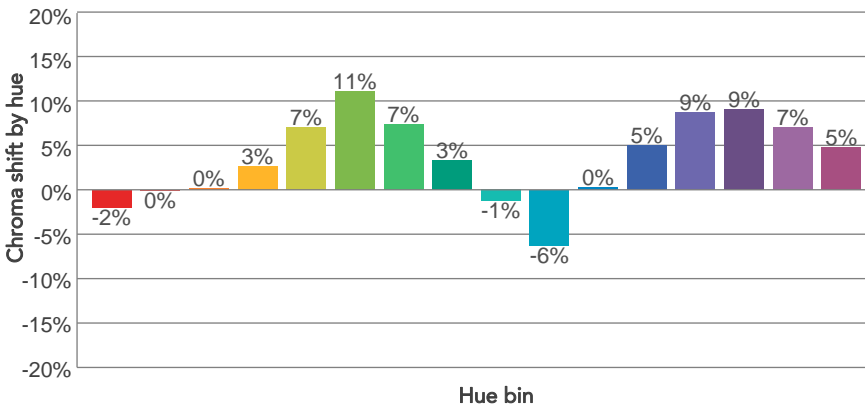
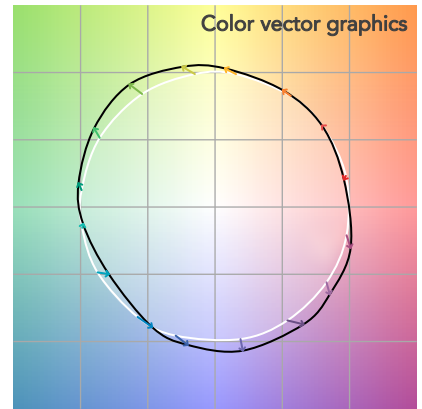
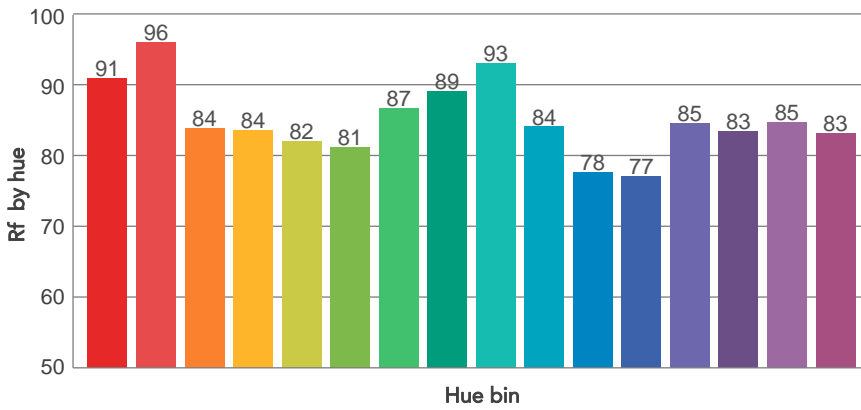
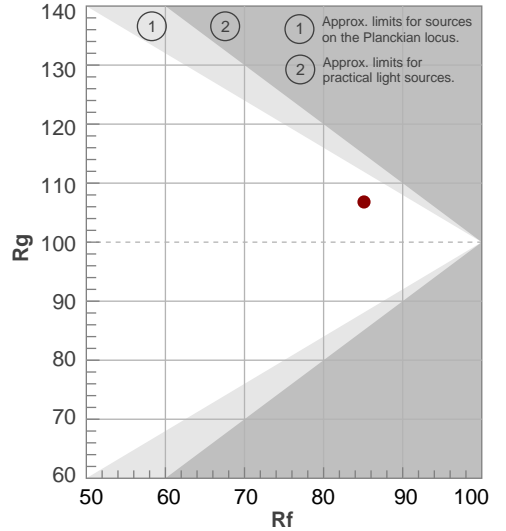

Color Evaluation Sample

# BEAM DETAILS



Beam angle 50%	Field angle 10%	Cutoff angle 2,5%	Intensity ratio in 120° cone	Intensity ratio in 90° cone
56,6°	91,7°	108°	99,5%	93,7%

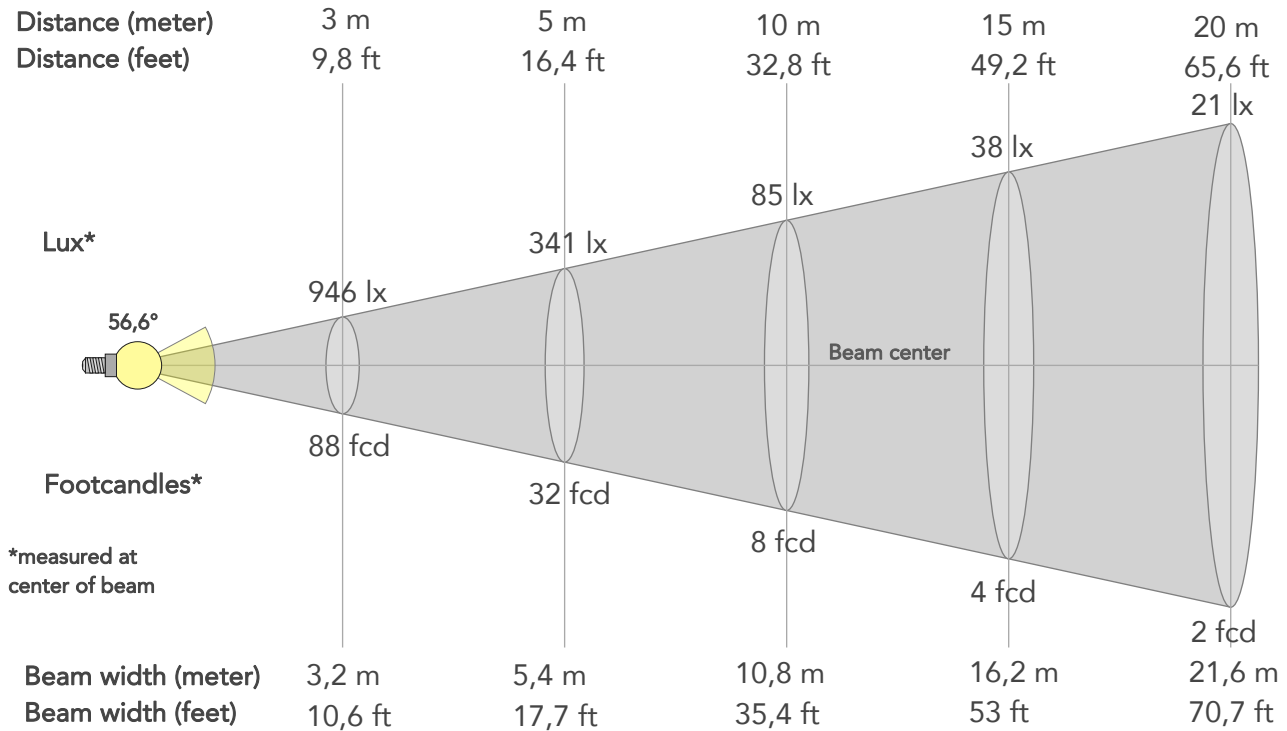

## BEAM INTENSITIES AND WIDTHS

Distance	1m	2m	3m	4m	5m	7,5m	10m	15m	20m	25m	30m	40m	50m
Distance	3,3ft	6,6ft	9,8ft	13,1ft	16,4ft	24,6ft	32,8ft	49,2ft	65,6ft	82ft	98,4ft	131,2ft	164ft
Lux	8515lx	2129lx	946lx	532lx	341lx	151lx	85lx	38lx	21lx	14lx	9lx	5lx	3lx
Footcand.	791fcd	198fcd	88fcd	49fcd	32fcd	14fcd	8fcd	4fcd	2fcd	1fcd	1fcd	0fcd	0fcd
Beam wid.	1,1m	2,2m	3,2m	4,3m	5,4m	8,1m	10,8m	16,2m	21,6m	26,9m	32,3m	43,1m	53,9m
Beam wid.	3,6ft	7,1ft	10,6ft	14,1ft	17,7ft	26,5ft	35,4ft	53ft	70,7ft	88,4ft	106,1ft	141,4ft	176,8ft

## LINEAR DISTRIBUTION DIAGRAM

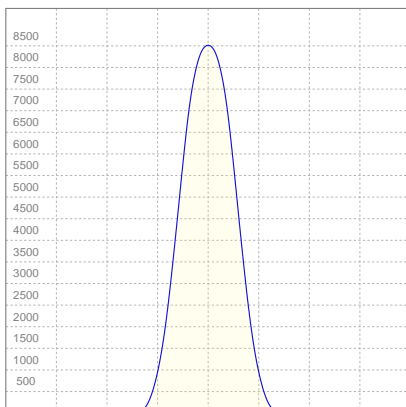

## ELECTRICAL SPECIFICATIONS

Input voltage	Input current	Input power	Effeciency
226V	0,922A	190,2W	41lm/W

## ISO CANDELA DIAGRAM

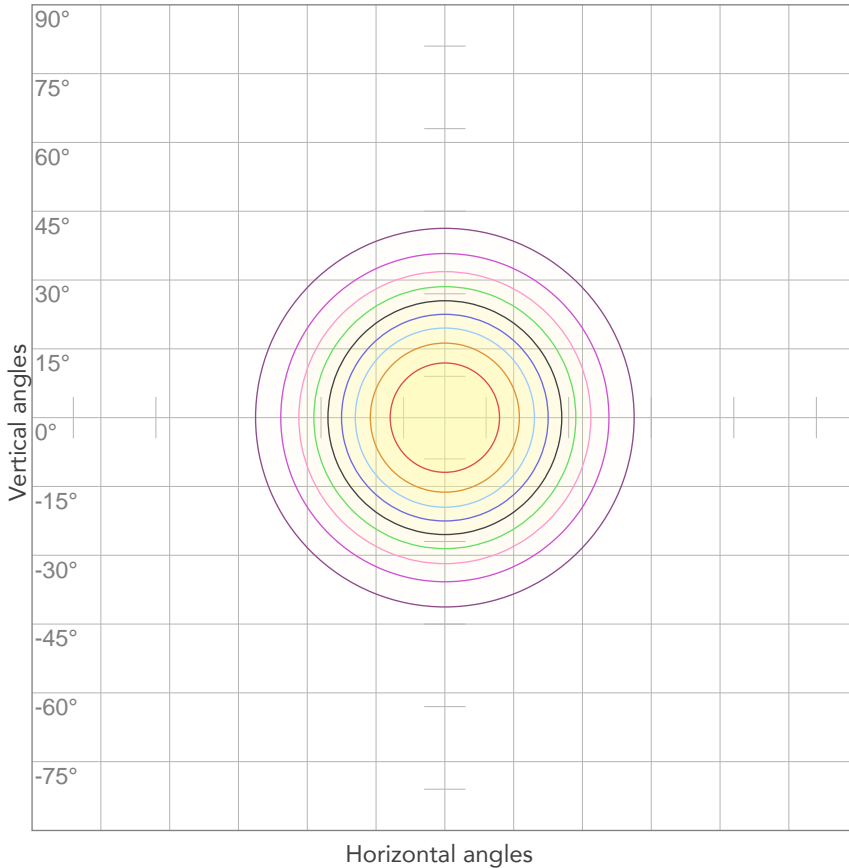

10%	851 cd
20%	1703 cd
30%	2554 cd
40%	3406 cd
50%	4257 cd
60%	5109 cd
70%	5960 cd
80%	6812 cd

Conditions:

Number of c-planes: 2

Candela at center: 8515 cd

## ISO LUX DIAGRAM

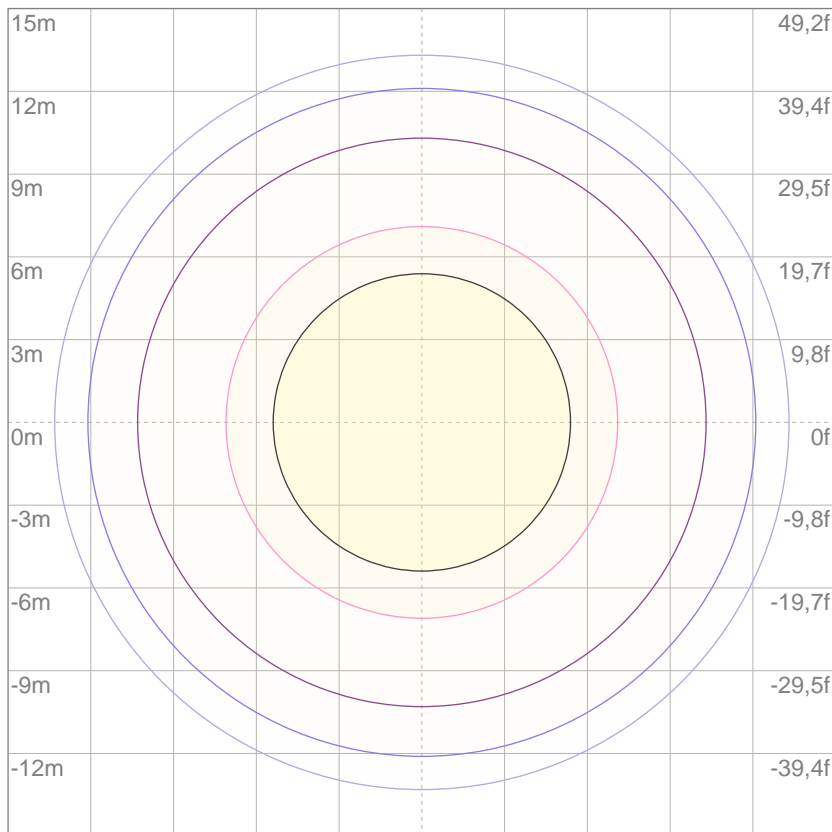

3%	2,55 lx
5%	4,26 lx
10%	8,51 lx
30%	25,5 lx
50%	42,6 lx

Conditions:

Number of c-planes: 2

Lux at center: 85,1 lx

*Lux distribution on a surface when lamp is mounted at 10 meters from the surface.*

Mounting height: 10 meters (33 feet)



Total lumen output:

7073 lm

Total candela output:

22637 cd

Light quality:

CRI: 91,0

Color temperature:

4009 K

**PRODUCT NAME:**

EclipseFresnel TW

**MEASUREMENT CONDITIONS:**

Beam angle:

30°

Target:

4000K

Operator:

Marco Marrocco

Date and time:

14/12/2019 11:56:54

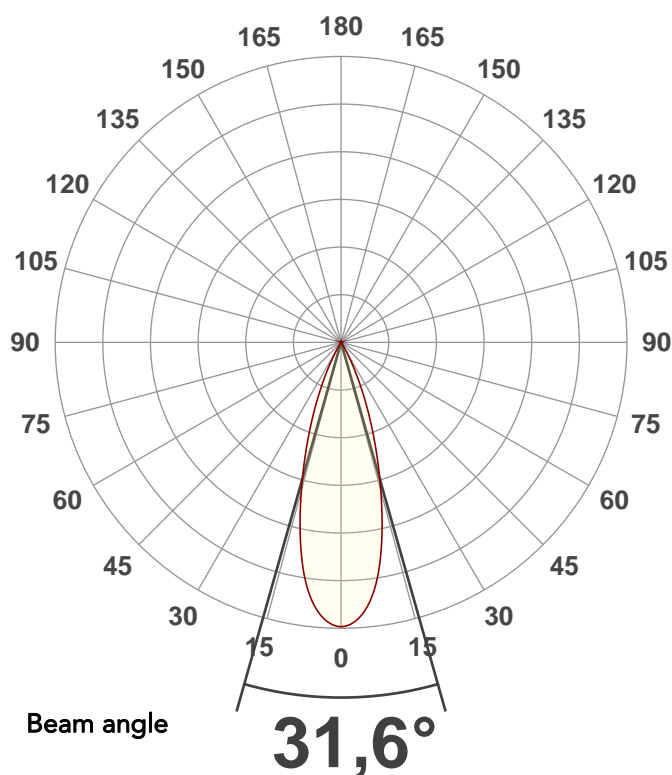

Spectra

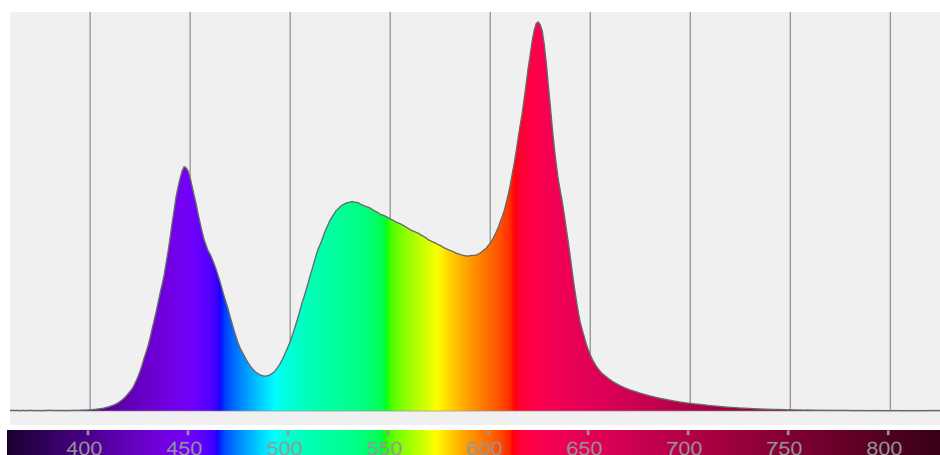

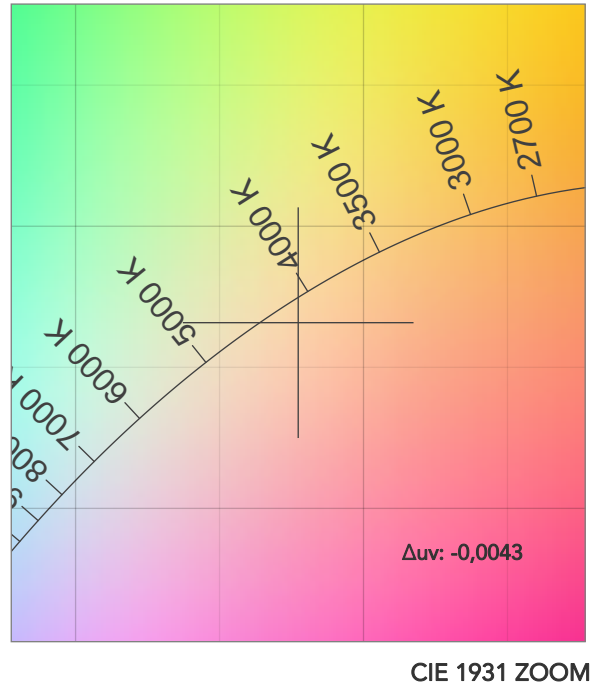
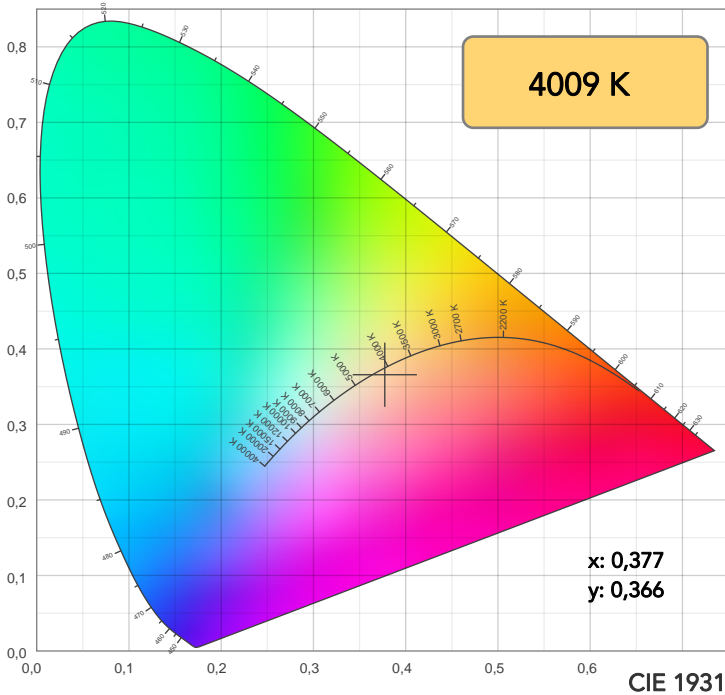

TM30: 85,3

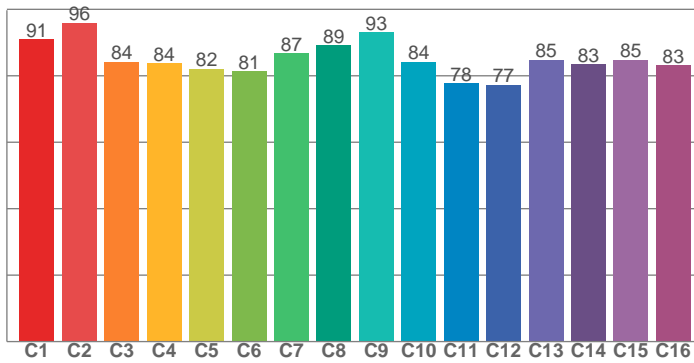

CRI: 91,0 (R1-R8)

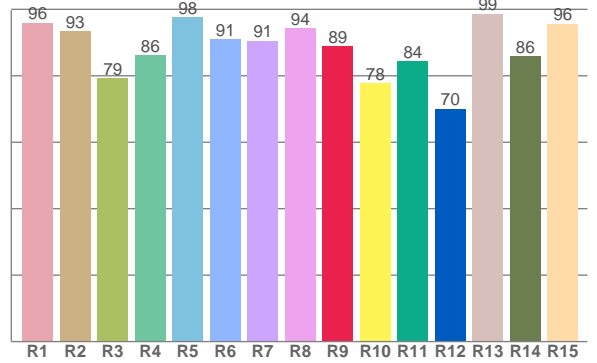

CQS: 89,1

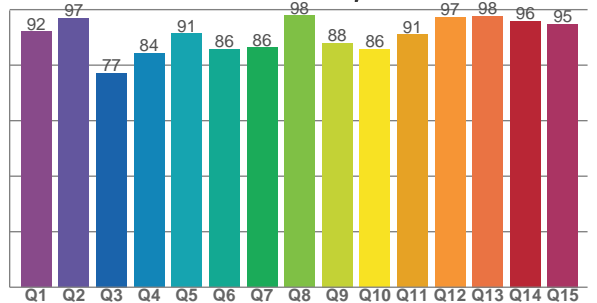

CRI R values, only R1-R8 are used to calculate final CRI value

R1	R2	R3	R4	R5	R6	R7	R8	R9	R10	R11	R12	R13	R14	R15
95,9	93,4	79,3	86,2	97,5	90,9	90,6	94,2	88,9	77,7	84,5	70,0	98,7	85,8	95,6

TM30 C values, 16 binned values out of total of 99 C values

C1	C2	C3	C4	C5	C6	C7	C8	C9	C10	C11	C12	C13	C14	C15	C16
91,0	96,0	84,2	83,8	82,1	81,3	86,8	89,1	93,0	84,1	77,8	77,3	84,8	83,4	84,9	83,1

CQS Q values

Q1	Q2	Q3	Q4	Q5	Q6	Q7	Q8	Q9	Q10	Q11	Q12	Q13	Q14	Q15
92,1	96,9	77,2	84,2	91,4	85,7	86,4	97,9	87,9	85,7	91,0	97,4	97,6	96,0	94,9

COLOR PARAMETERS

Color temperature	Color rendering index	Red component	Color fidelity	Color gamut	Color quality scale	Television lighting index	Color coordinate cie 1931	Color coordinate cie 1931	Color deviation from black body
CCT	CRI	CRI R9	TM30 Rf	TM30 Rg	CQS	TLCI	x	y	Δuv
4009 K	91,0	88,9	85,3	106,8	89,1	75	0,377	0,366	-0,0043



# TM30 DETAILS

**Rf 85,3**  
Fidelity index Rf

**Rg 106,8**  
Gammut index

Hue Bin	R <sub>f</sub>	Graphic shifts (%)	
		Chroma	Hue
1	91	-2%	-2%
2	96	0%	0%
3	84	0%	7%
4	84	3%	9%
5	82	7%	8%
6	81	11%	4%
7	87	7%	-4%
8	89	3%	-4%
9	93	-1%	-3%
10	84	-6%	6%
11	78	0%	13%
12	77	5%	10%
13	85	9%	0%
14	83	9%	8%
15	85	7%	-6%
16	83	5%	-8%

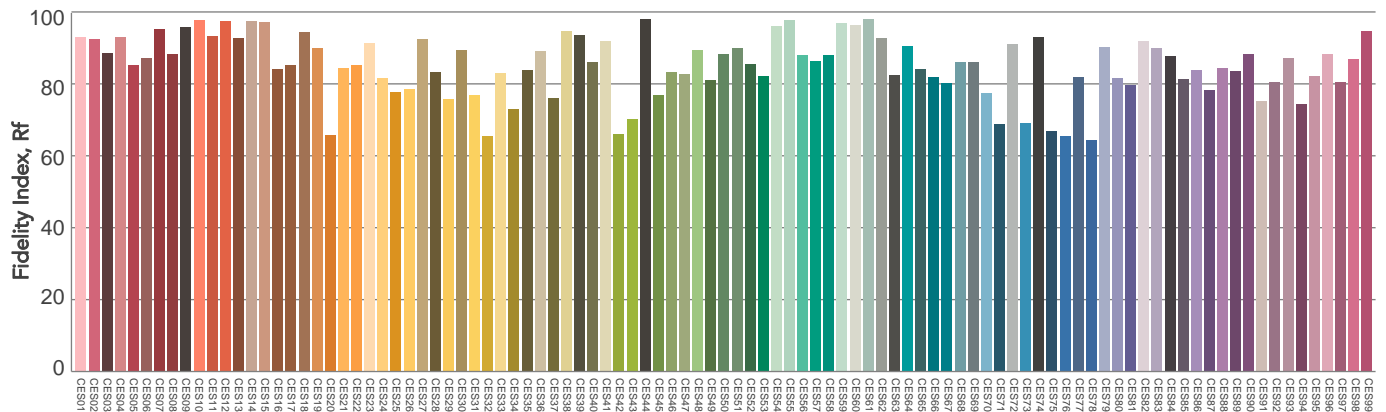
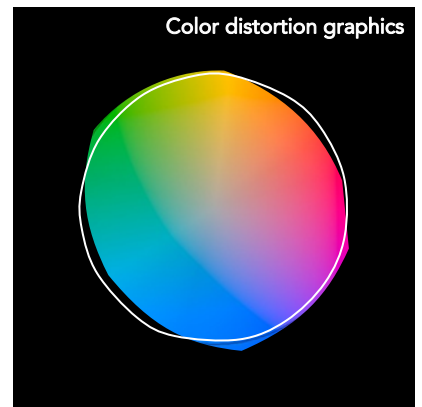
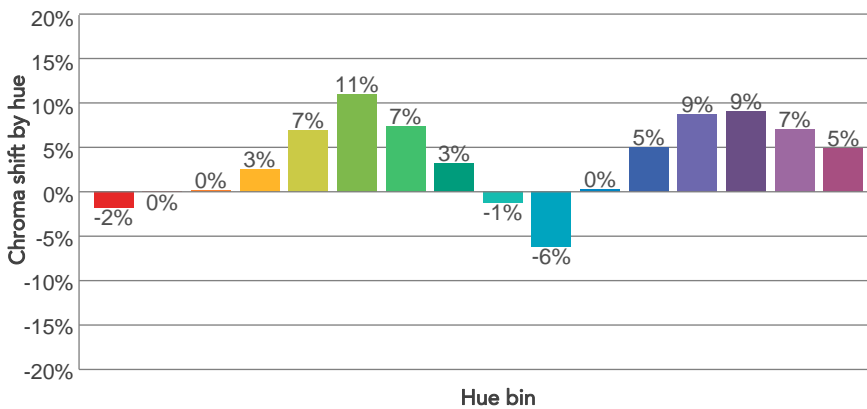
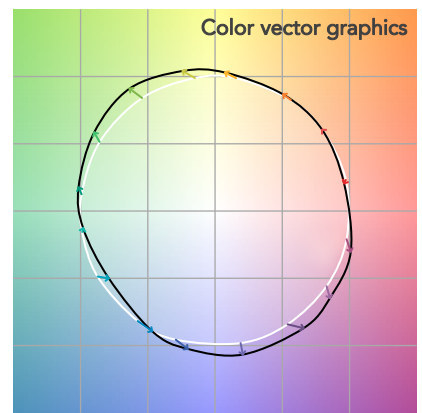
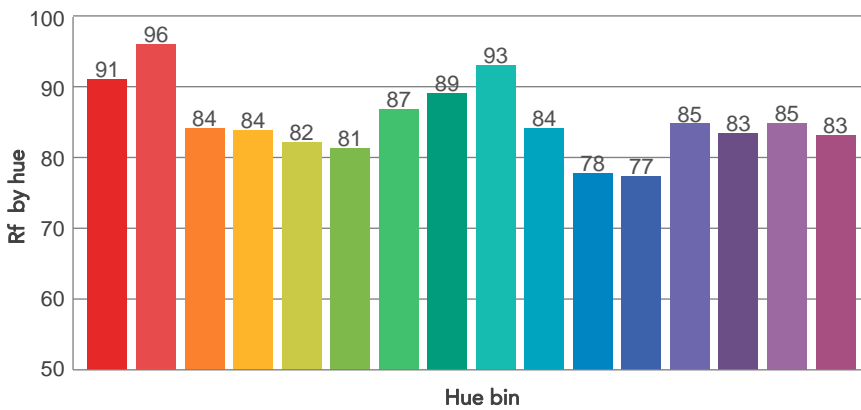
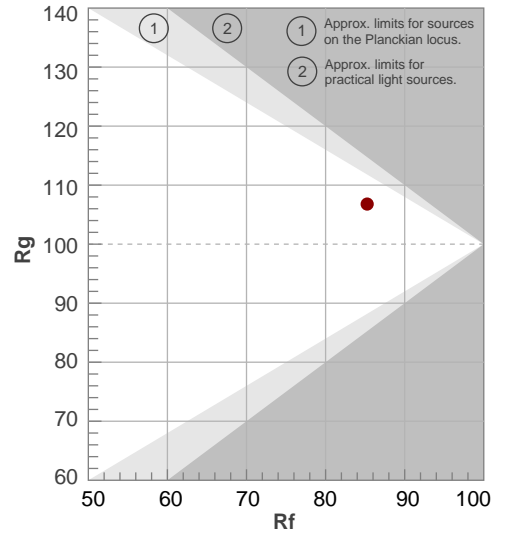

Color Evaluation Sample

# BEAM DETAILS



Beam angle 50%	Field angle 10%	Cutoff angle 2,5%	Intensity ratio in 120° cone	Intensity ratio in 90° cone
31,6°	53,1°	62°	99,4%	98,3%

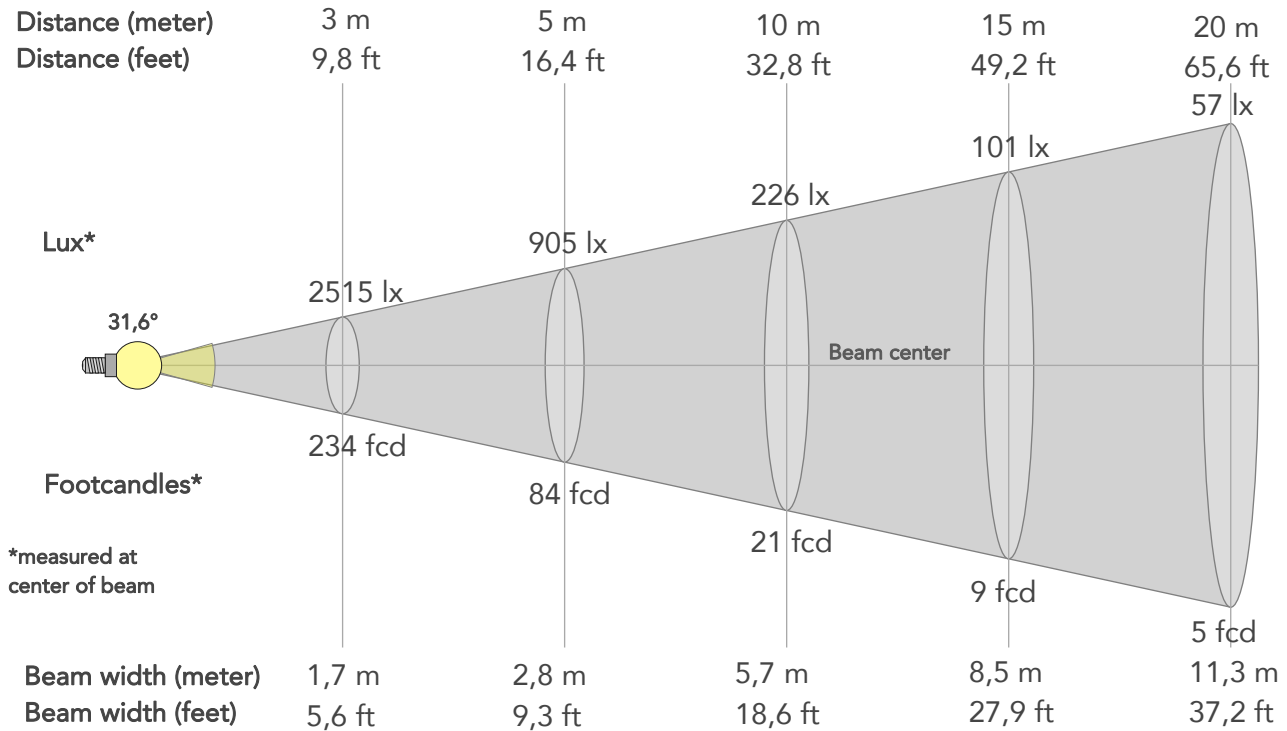

## BEAM INTENSITIES AND WIDTHS

Distance	1m	2m	3m	4m	5m	7,5m	10m	15m	20m	25m	30m	40m	50m
Distance	3,3ft	6,6ft	9,8ft	13,1ft	16,4ft	24,6ft	32,8ft	49,2ft	65,6ft	82ft	98,4ft	131,2ft	164ft
Lux	22637lx	5659lx	2515lx	1415lx	905lx	402lx	226lx	101lx	57lx	36lx	25lx	14lx	9lx
Footcand.	2103fcd	526fcd	234fcd	131fcd	84fcd	37fcd	21fcd	9fcd	5fcd	3fcd	2fcd	1fcd	1fcd
Beam wid.	0,6m	1,1m	1,7m	2,3m	2,8m	4,2m	5,7m	8,5m	11,3m	14,2m	17m	22,7m	28,3m
Beam wid.	1,9ft	3,7ft	5,6ft	7,4ft	9,3ft	13,9ft	18,6ft	27,9ft	37,2ft	46,5ft	55,7ft	74,3ft	92,9ft

## LINEAR DISTRIBUTION DIAGRAM

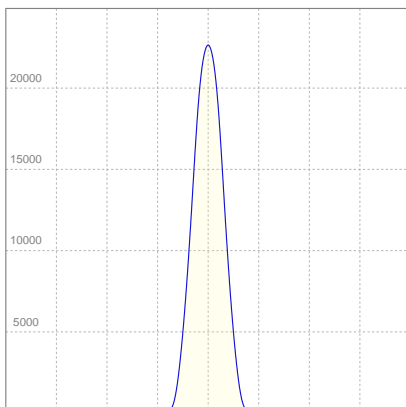

## ELECTRICAL SPECIFICATIONS

Input voltage	Input current	Input power	Effeciency
229V	0,900A	187,1W	38lm/W

## ISO CANDELA DIAGRAM

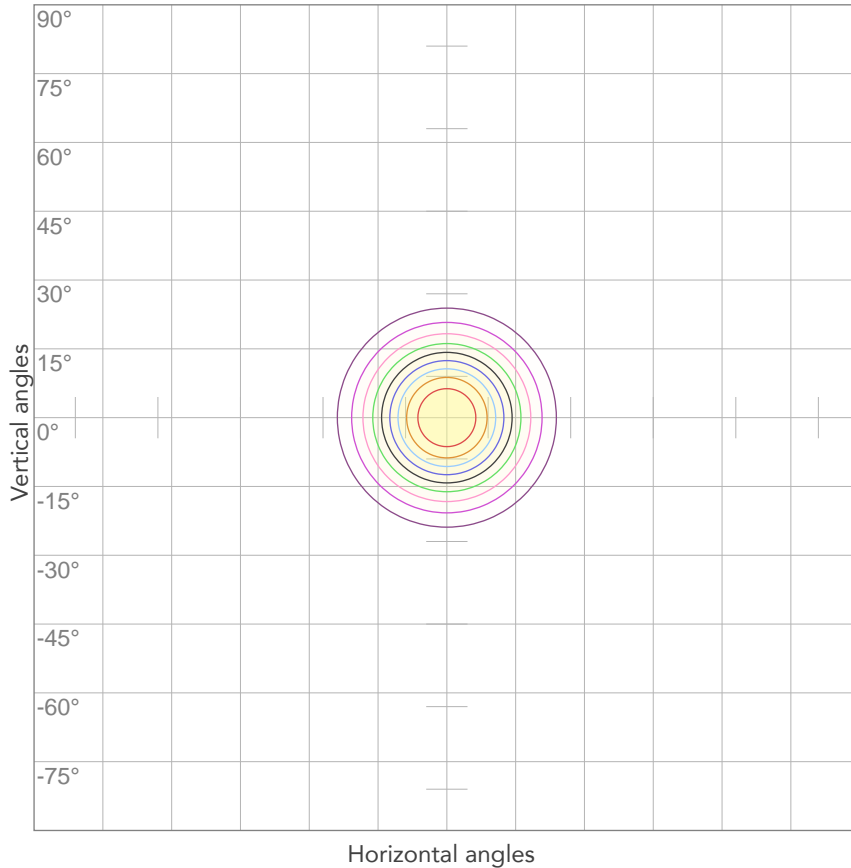

10%	2264 cd
20%	4527 cd
30%	6791 cd
40%	9055 cd
50%	11318 cd
60%	13582 cd
70%	15846 cd
80%	18109 cd

Conditions:

Number of c-planes: 2

Candela at center: 22637 cd

## ISO LUX DIAGRAM

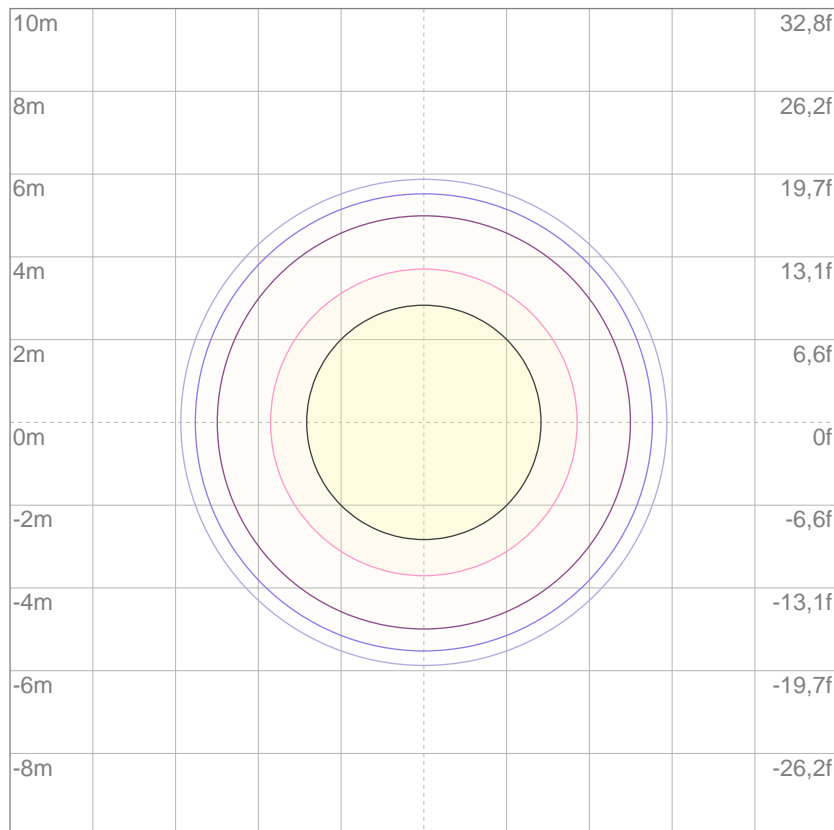

3%	6,79 lx
5%	11,3 lx
10%	22,6 lx
30%	67,9 lx
50%	113 lx

Conditions:

Number of c-planes: 2

Lux at center: 226 lx

*Lux distribution on a surface when lamp is mounted at 10 meters from the surface.*

Mounting height: 10 meters (33 feet)



Total lumen output:

4421 lm

Total candela output:

39636 cd

Light quality:

CRI: 91,0

Color temperature:

3970 K

## PRODUCT NAME:

EclipseFresnel TW

## MEASUREMENT CONDITIONS:

Beam angle:

15°

Target:

4000K

Operator:

Marco Marrocco

Date and time:

14/12/2019 11:16:44

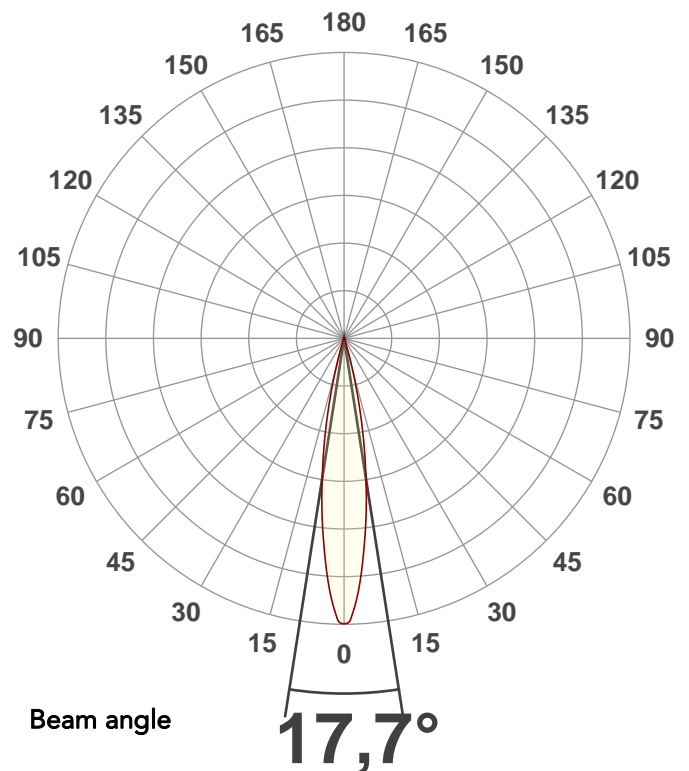

Spectra

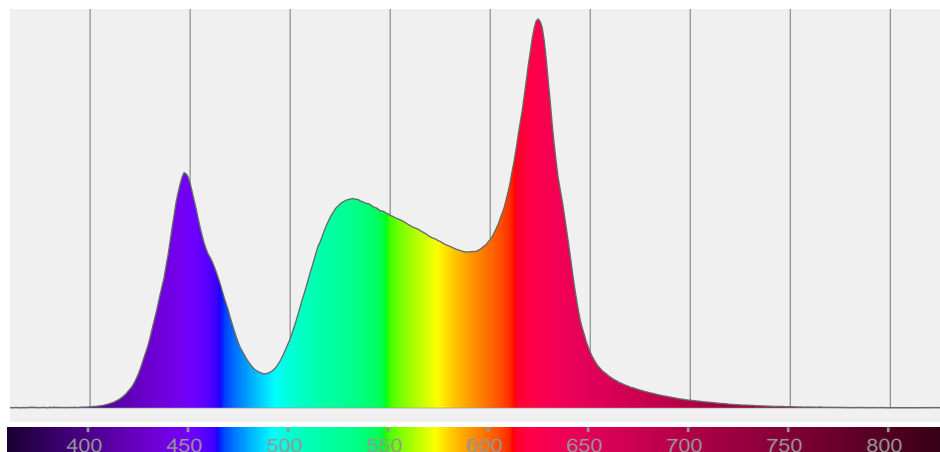

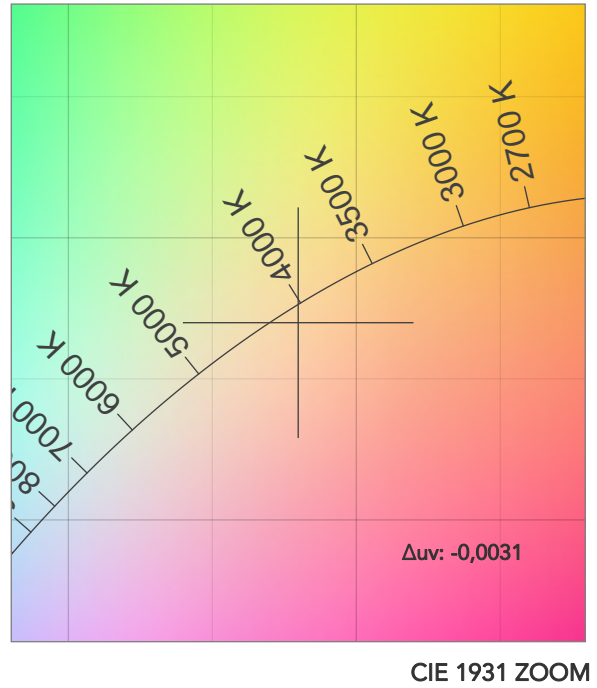
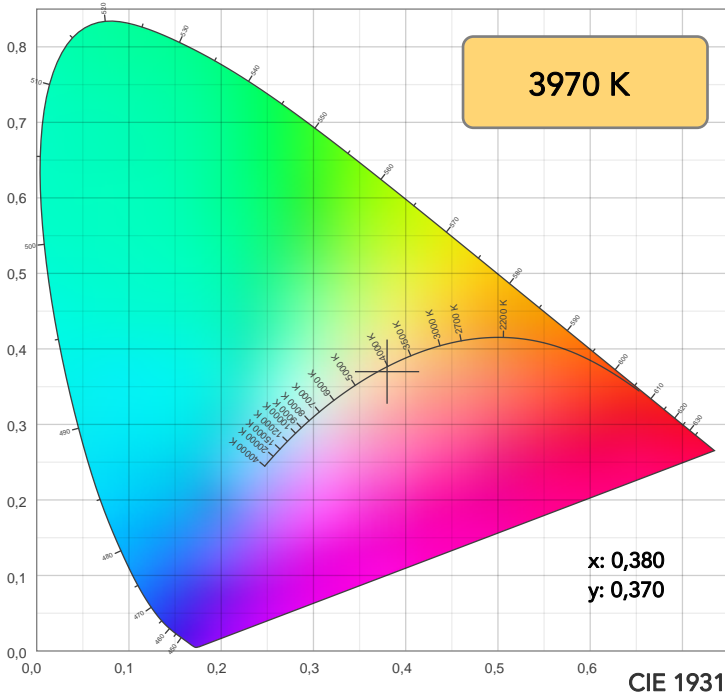

TM30: 85,4

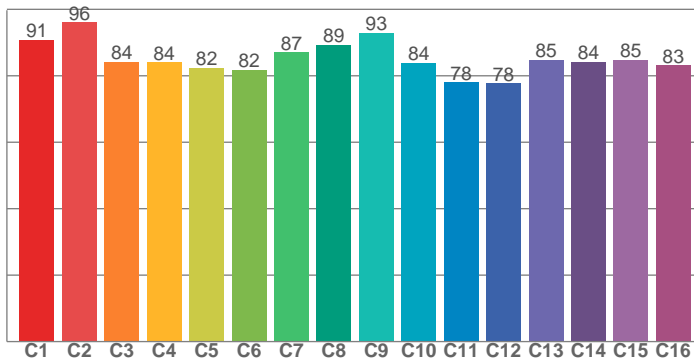

CRI: 91,0 (R1-R8)

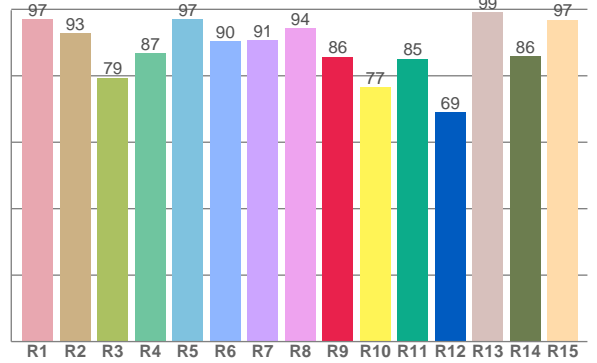

CRI R values, only R1-R8 are used to calculate final CRI value

R1	R2	R3	R4	R5	R6	R7	R8	R9	R10	R11	R12	R13	R14	R15
96,9	92,9	79,4	86,7	97,1	90,4	90,6	94,3	85,7	76,6	85,1	69,0	99,1	85,9	96,8

TM30 C values, 16 binned values out of total of 99 C values

C1	C2	C3	C4	C5	C6	C7	C8	C9	C10	C11	C12	C13	C14	C15	C16
90,8	96,1	84,2	84,0	82,4	81,7	87,0	89,4	92,9	83,9	78,0	77,7	84,7	84,1	84,8	83,2

CQS Q values

Q1	Q2	Q3	Q4	Q5	Q6	Q7	Q8	Q9	Q10	Q11	Q12	Q13	Q14	Q15
91,6	97,1	77,7	84,5	91,1	85,7	86,2	97,6	88,4	86,0	91,4	97,5	97,4	95,8	94,2

CQS: 89,1

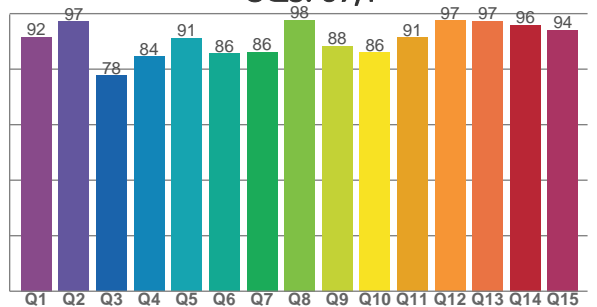

COLOR PARAMETERS

Color temperature	Color rendering index	Red component	Color fidelity	Color gamut	Color quality scale	Television lighting index	Color coordinate cie 1931	Color coordinate cie 1931	Color deviation from black body
CCT	CRI	CRI R9	TM30 Rf	TM30 Rg	CQS	TLCI	x	y	Δuv
3970 K	91,0	85,7	85,4	106,3	89,1	75	0,380	0,370	-0,0031

# TM30 DETAILS

**Rf 85,4**  
Fidelity index Rf

**Rg 106,3**  
Gammut index

Hue Bin	R <sub>f</sub>	Graphic shifts (%)	
		Chroma	Hue
1	91	-2%	-2%
2	96	0%	0%
3	84	0%	7%
4	84	2%	9%
5	82	7%	8%
6	82	11%	4%
7	87	7%	-4%
8	89	3%	-5%
9	93	-2%	-3%
10	84	-6%	6%
11	78	0%	13%
12	78	5%	10%
13	85	9%	0%
14	84	9%	8%
15	85	7%	-6%
16	83	5%	-9%

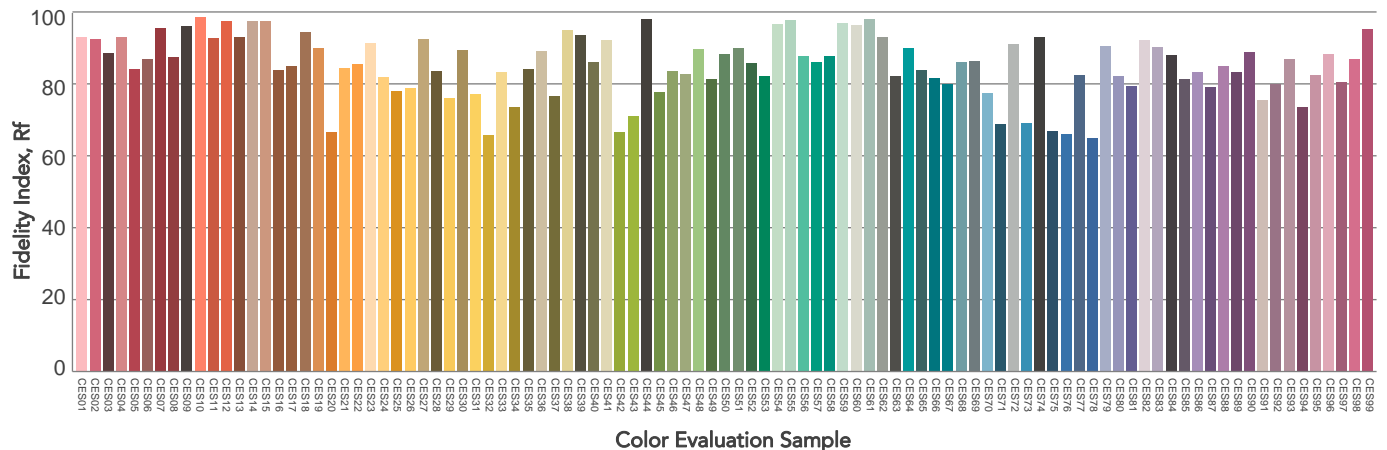
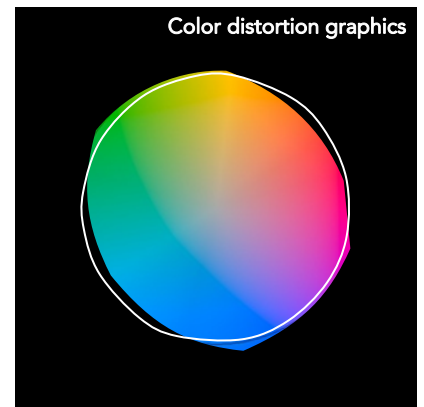
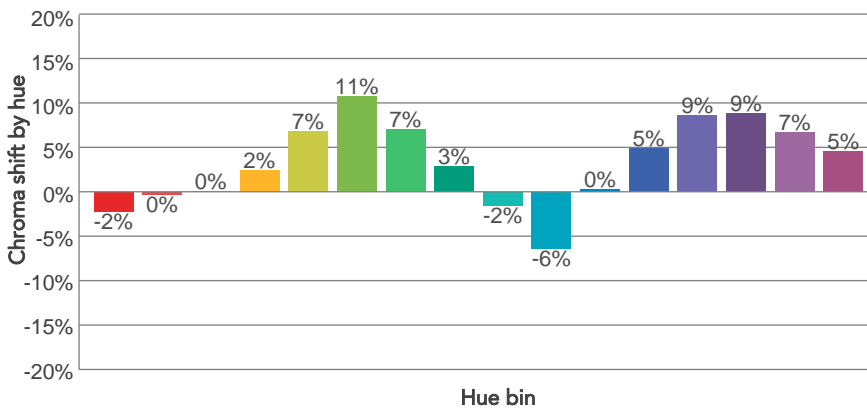
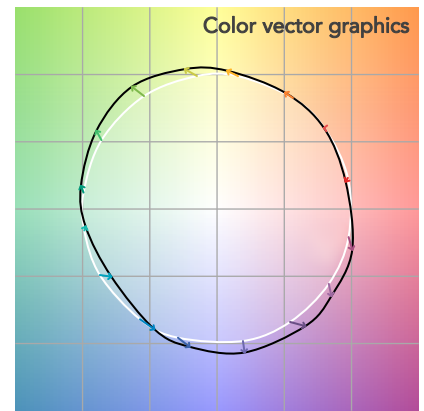
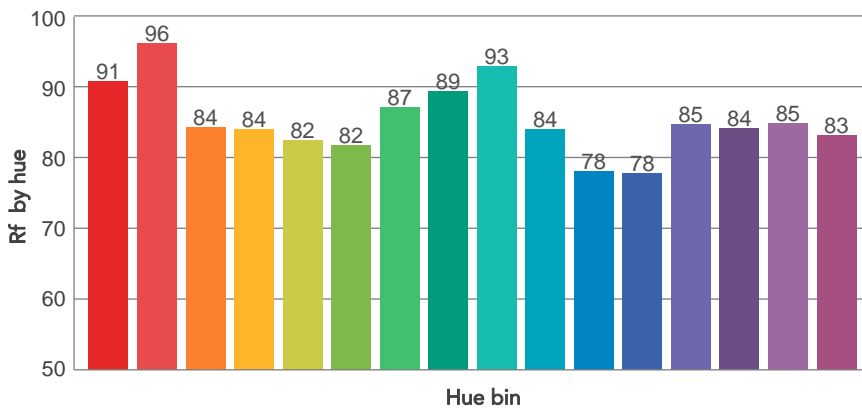
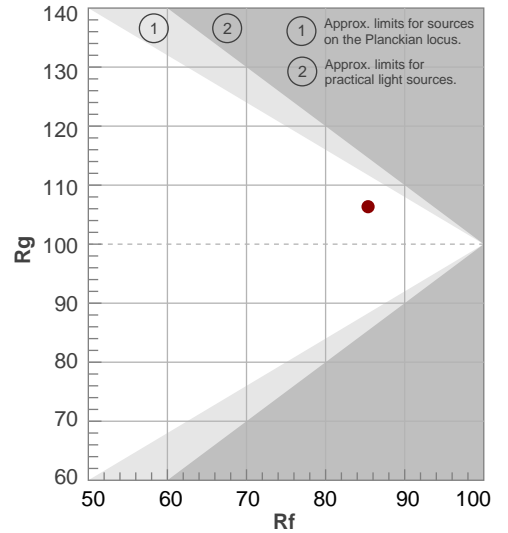

# BEAM DETAILS



Beam angle 50%	Field angle 10%	Cutoff angle 2,5%	Intensity ratio in 120° cone	Intensity ratio in 90° cone
17,7°	31°	38°	99,4%	98,0%

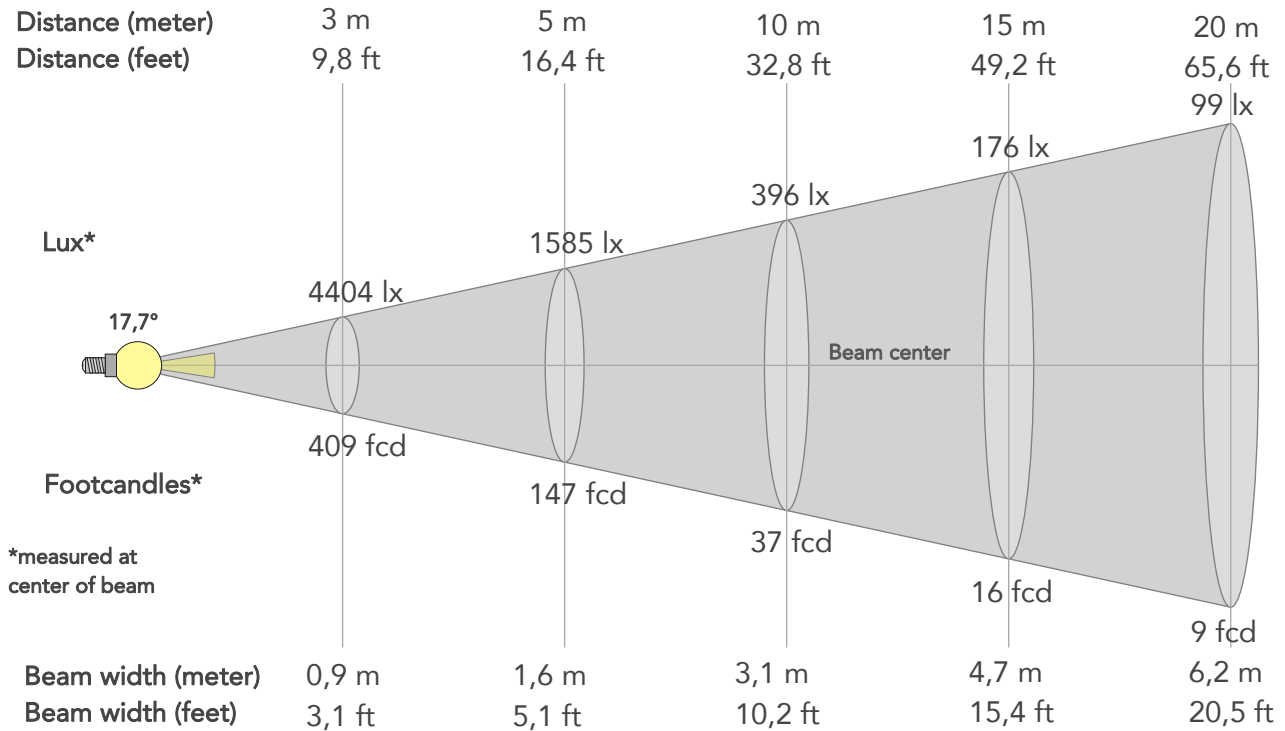

## BEAM INTENSITIES AND WIDTHS

Distance	1m	2m	3m	4m	5m	7,5m	10m	15m	20m	25m	30m	40m	50m
Distance	3,3ft	6,6ft	9,8ft	13,1ft	16,4ft	24,6ft	32,8ft	49,2ft	65,6ft	82ft	98,4ft	131,2ft	164ft
Lux	39636lx	9909lx	4404lx	2477lx	1585lx	705lx	396lx	176lx	99lx	63lx	44lx	25lx	16lx
Footcand.	3682fcd	921fcd	409fcd	230fcd	147fcd	65fcd	37fcd	16fcd	9fcd	6fcd	4fcd	2fcd	1fcd
Beam wid.	0,3m	0,6m	0,9m	1,2m	1,6m	2,3m	3,1m	4,7m	6,2m	7,8m	9,4m	12,5m	15,6m
Beam wid.	1ft	2,1ft	3,1ft	4,1ft	5,1ft	7,7ft	10,2ft	15,4ft	20,5ft	25,6ft	30,7ft	40,9ft	51,2ft

## LINEAR DISTRIBUTION DIAGRAM

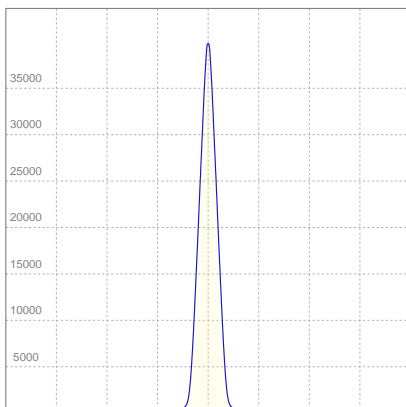

## ELECTRICAL SPECIFICATIONS

Input voltage	Input current	Input power	Efficiency
227V	0,893A	184,5W	24lm/W

## ISO CANDELA DIAGRAM

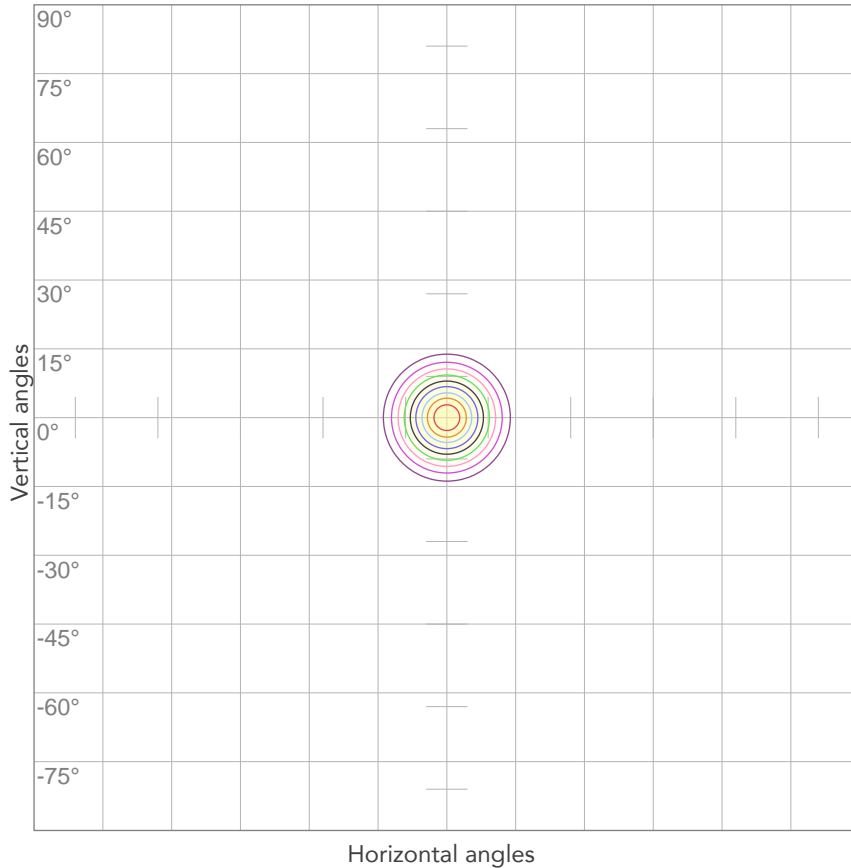

10%	3964 cd
20%	7927 cd
30%	11891 cd
40%	15854 cd
50%	19818 cd
60%	23782 cd
70%	27745 cd
80%	31709 cd

Conditions:

Number of c-planes: 2

Candela at center: 39636 cd

## ISO LUX DIAGRAM

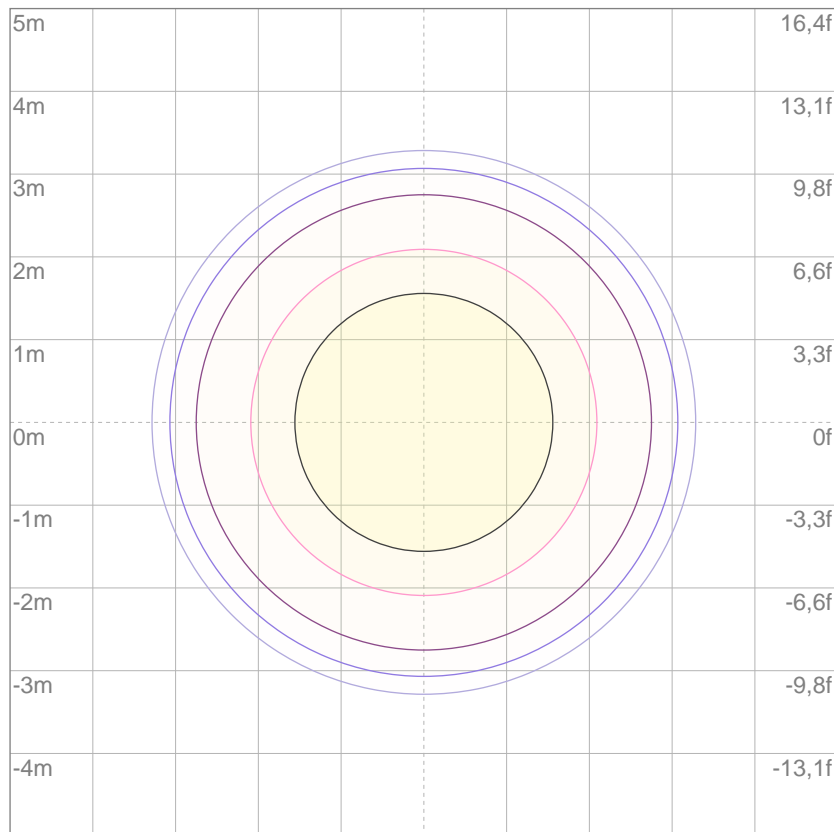

3%	11,9 lx
5%	19,8 lx
10%	39,6 lx
30%	119 lx
50%	198 lx

Conditions:

Number of c-planes: 2

Lux at center: 396 lx

*Lux distribution on a surface when lamp is mounted at 10 meters from the surface.*

Mounting height: 10 meters (33 feet)





Total lumen output:

7453 lm

Total candela output:

8151 cd

Light quality:

CRI: 88,9

Color temperature:

5592 K

## PRODUCT NAME:

EclipseFresnel TW

## MEASUREMENT CONDITIONS:

Beam angle:

45°

Target:

5600K

Operator:

Marco Marrocco

Date and time:

14/12/2019 10:51:36

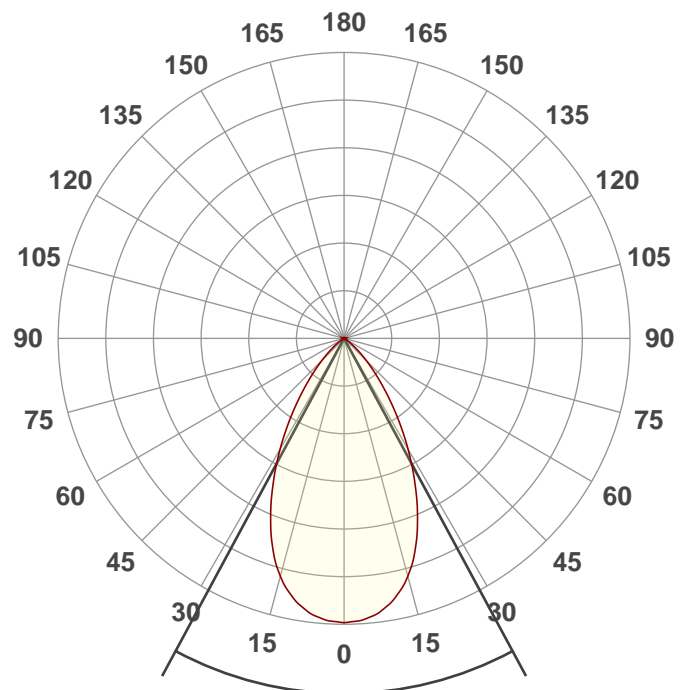

Beam angle

**56,6°**

Spectra

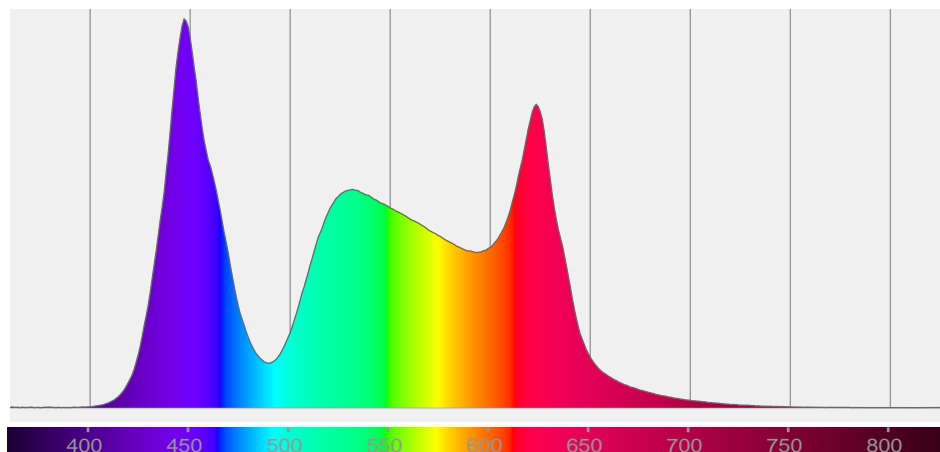

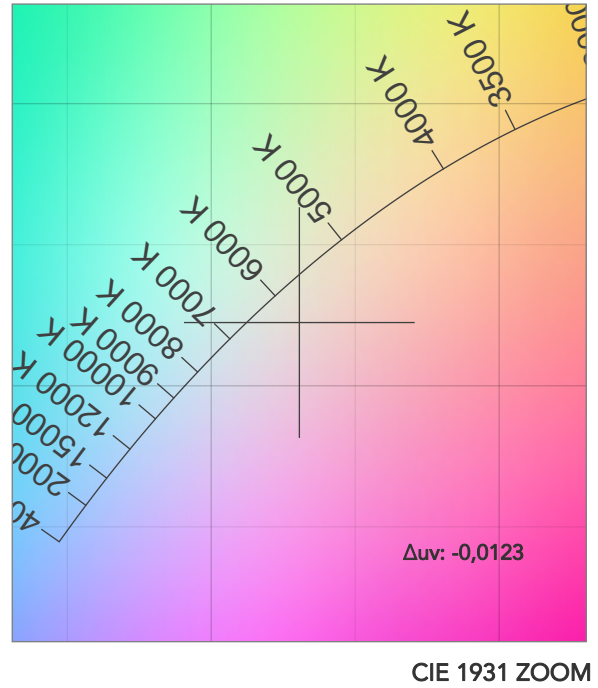
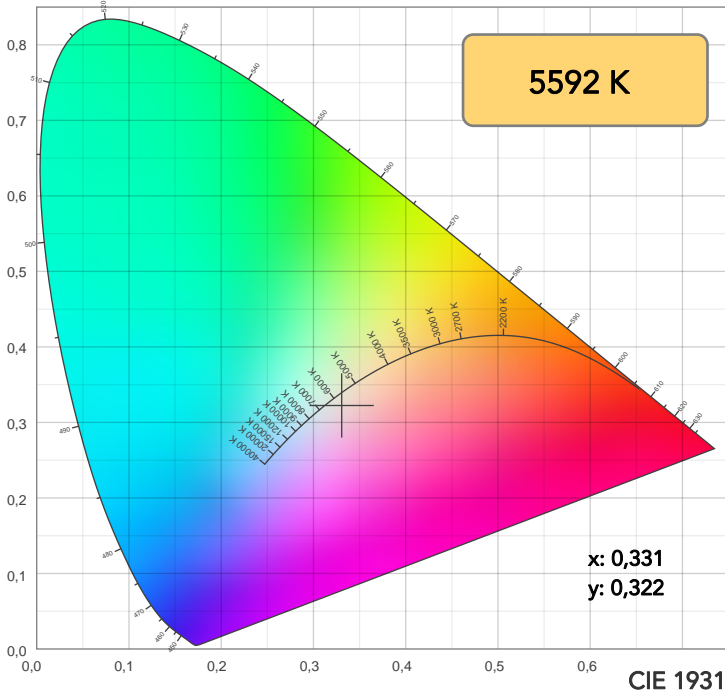

TM30: 81,0

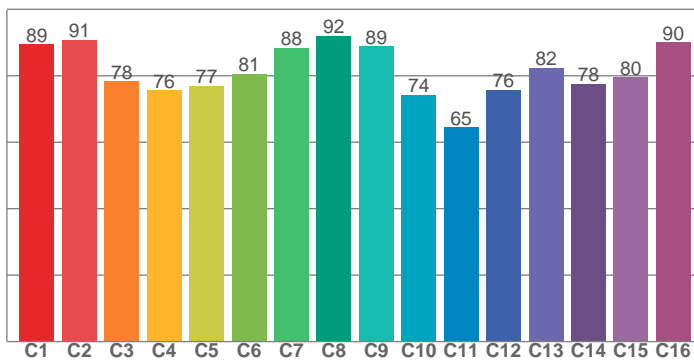

CRI: 88,9 (R1-R8)

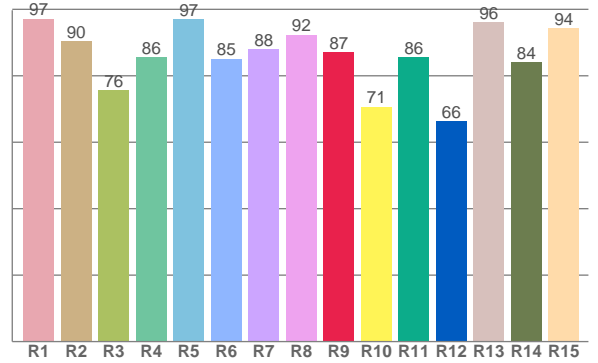

CQS: 83,7

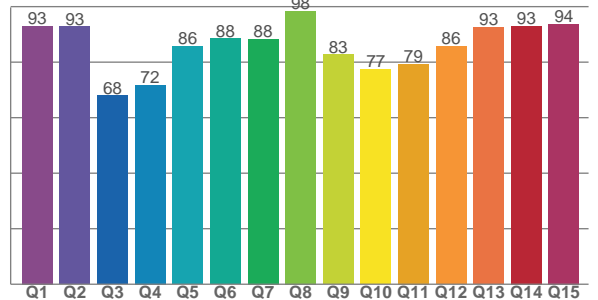

CRI R values, only R1-R8 are used to calculate final CRI value

R1	R2	R3	R4	R5	R6	R7	R8	R9	R10	R11	R12	R13	R14	R15
97,1	90,4	75,7	85,5	97,0	85,2	87,9	92,4	87,1	70,7	85,5	66,3	96,0	84,2	94,3

TM30 C values, 16 binned values out of total of 99 C values

C1	C2	C3	C4	C5	C6	C7	C8	C9	C10	C11	C12	C13	C14	C15	C16
89,4	90,8	78,3	75,6	76,9	80,7	88,3	92,0	88,9	74,2	64,5	75,8	82,4	77,5	79,6	90,1

CQS Q values

Q1	Q2	Q3	Q4	Q5	Q6	Q7	Q8	Q9	Q10	Q11	Q12	Q13	Q14	Q15
93,1	92,8	68,0	71,8	85,7	88,4	88,3	98,4	82,7	77,4	79,4	85,7	92,5	93,0	93,7

COLOR PARAMETERS

Color temperature	Color rendering index	Red component	Color fidelity	Color gamut	Color quality scale	Television lighting index	Color coordinate cie 1931	Color coordinate cie 1931	Color deviation from black body
CCT	CRI	CRI R9	TM30 Rf	TM30 Rg	CQS	TLCI	x	y	Δuv
5592 K	88,9	87,1	81,0	106,5	83,7	77	0,331	0,322	-0,0123

# TM30 DETAILS

**Rf 81,0**  
Fidelity index Rf

**Rg 106,5**  
Gammut index

Hue Bin	R <sub>f</sub>	Graphic shifts (%)	
		Chroma	Hue
1	89	-4%	-1%
2	91	-2%	3%
3	78	0%	11%
4	76	4%	13%
5	77	9%	11%
6	81	11%	4%
7	88	6%	-3%
8	92	0%	-3%
9	89	-7%	3%
10	74	-7%	12%
11	65	-1%	20%
12	76	5%	14%
13	82	11%	7%
14	78	10%	6%
15	80	14%	-8%
16	90	4%	-4%

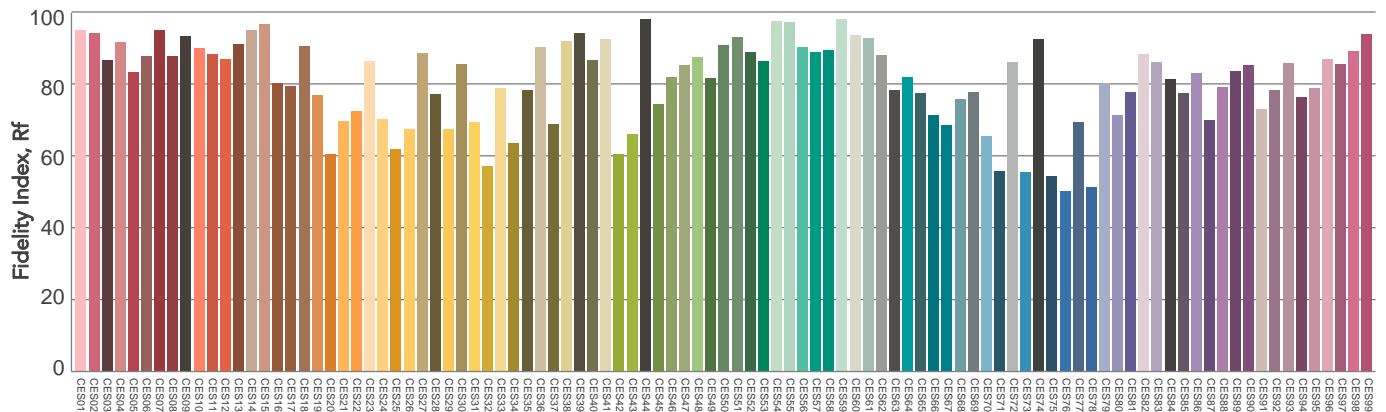
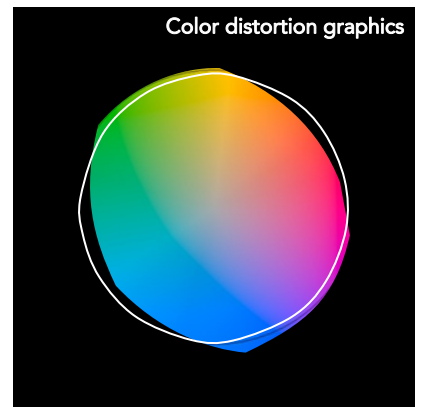
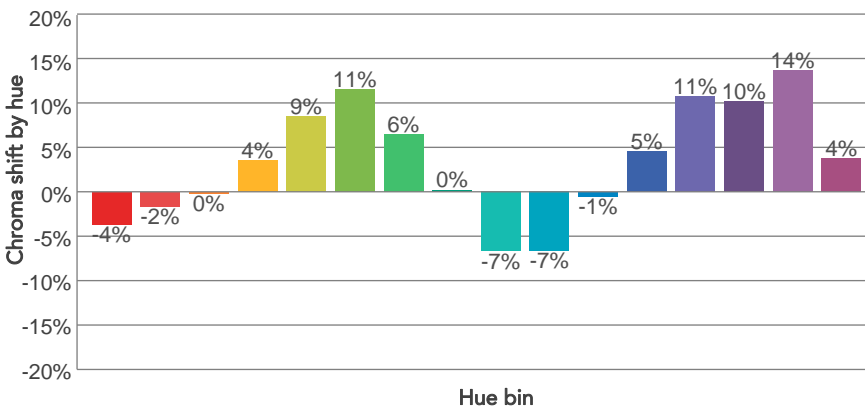
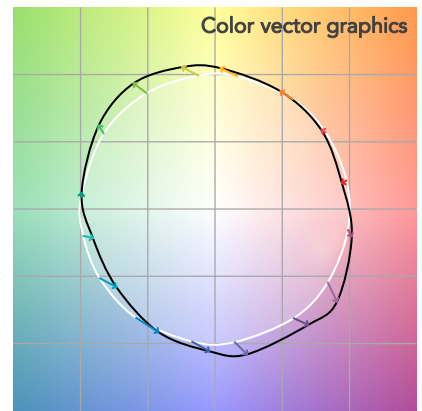
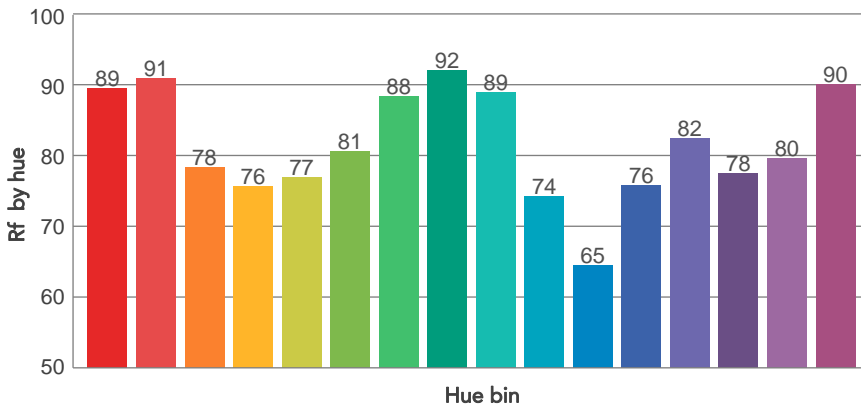
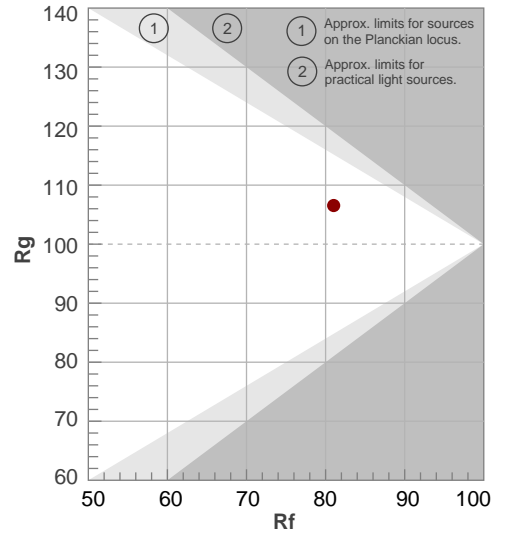

Color Evaluation Sample

# BEAM DETAILS



Beam angle 50%	Field angle 10%	Cutoff angle 2,5%	Intensity ratio in 120° cone	Intensity ratio in 90° cone
56,6°	91,7°	107,9°	99,5%	93,7%

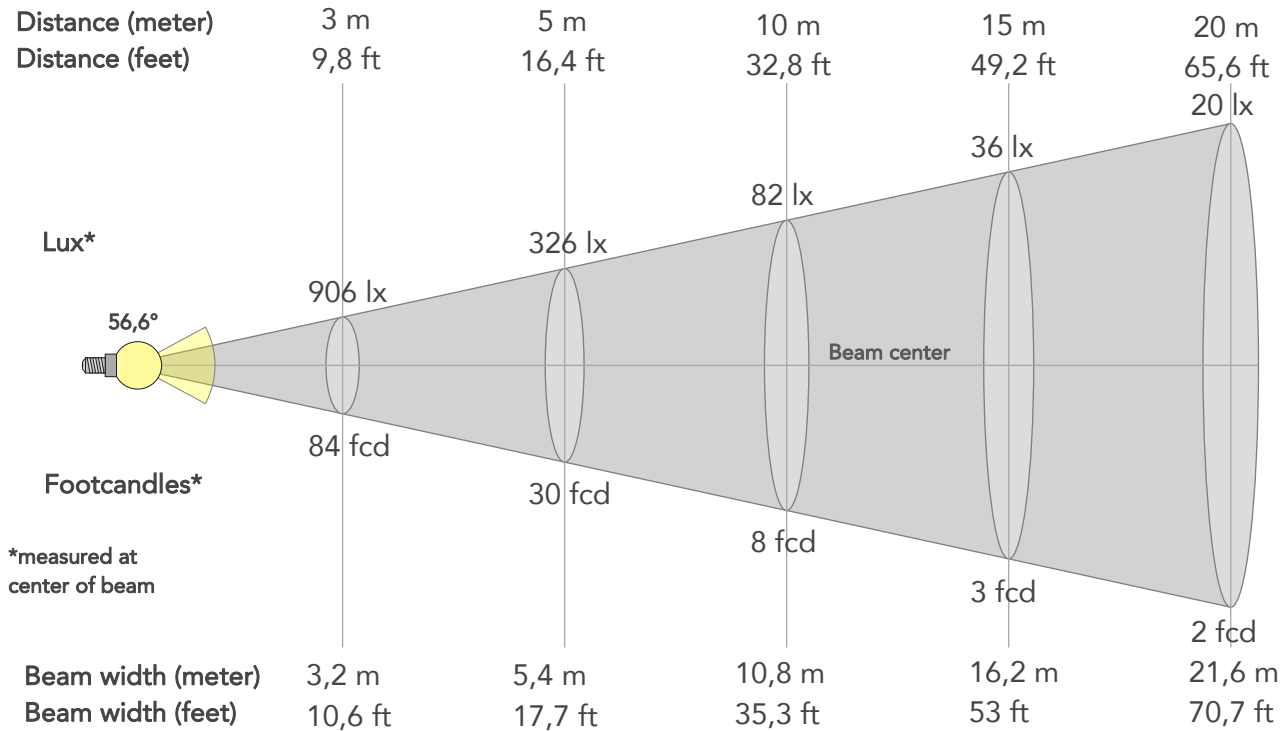

## BEAM INTENSITIES AND WIDTHS

Distance	1m	2m	3m	4m	5m	7,5m	10m	15m	20m	25m	30m	40m	50m
Distance	3,3ft	6,6ft	9,8ft	13,1ft	16,4ft	24,6ft	32,8ft	49,2ft	65,6ft	82ft	98,4ft	131,2ft	164ft
Lux	8151lx	2038lx	906lx	509lx	326lx	145lx	82lx	36lx	20lx	13lx	9lx	5lx	3lx
Footcand.	757fcd	189fcd	84fcd	47fcd	30fcd	13fcd	8fcd	3fcd	2fcd	1fcd	1fcd	0fcd	0fcd
Beam wid.	1,1m	2,2m	3,2m	4,3m	5,4m	8,1m	10,8m	16,2m	21,6m	26,9m	32,3m	43,1m	53,9m
Beam wid.	3,6ft	7,1ft	10,6ft	14,1ft	17,7ft	26,5ft	35,3ft	53ft	70,7ft	88,4ft	106ft	141,4ft	176,7ft

## LINEAR DISTRIBUTION DIAGRAM

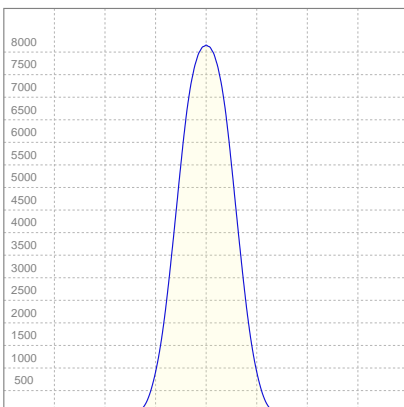

## ELECTRICAL SPECIFICATIONS

Input voltage	Input current	Input power	Effeciency
227V	0,916A	189,5W	39lm/W

## ISO CANDELA DIAGRAM

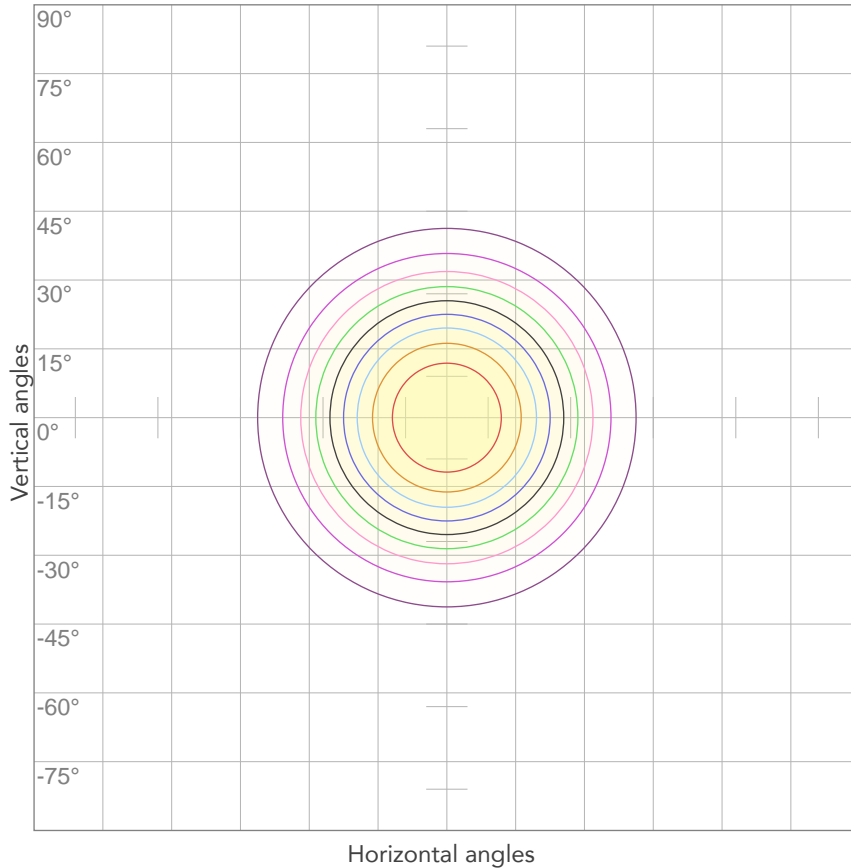

10%	815 cd
20%	1630 cd
30%	2445 cd
40%	3261 cd
50%	4076 cd
60%	4891 cd
70%	5706 cd
80%	6521 cd

Conditions:

Number of c-planes: 2

Candela at center: 8151 cd

## ISO LUX DIAGRAM

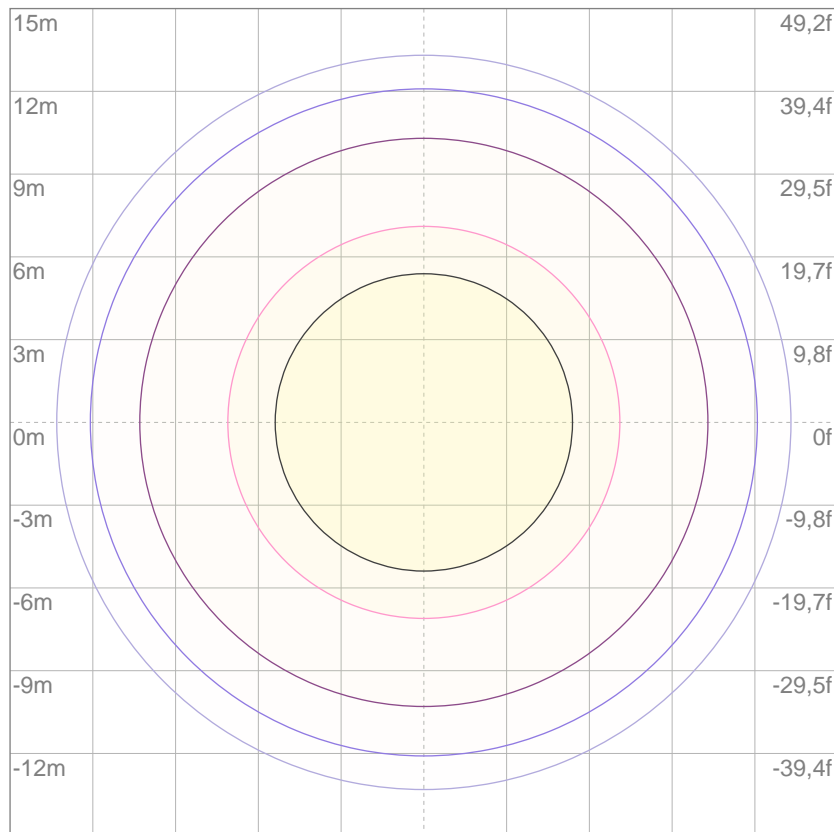

3%	2,45 lx
5%	4,08 lx
10%	8,15 lx
30%	24,5 lx
50%	40,8 lx

Conditions:

Number of c-planes: 2

Lux at center: 81,5 lx

*Lux distribution on a surface when lamp is mounted at 10 meters from the surface.*

Mounting height: 10 meters (33 feet)



Total lumen output:

6844 lm

Total candela output:

21900 cd

Light quality:

CRI: 89,0

Color temperature:

5566 K

**PRODUCT NAME:**

EclipseFresnel TW

**MEASUREMENT CONDITIONS:**

Beam angle:

30°

Target:

5600K

Operator:

Marco Marrocco

Date and time:

14/12/2019 11:59:05

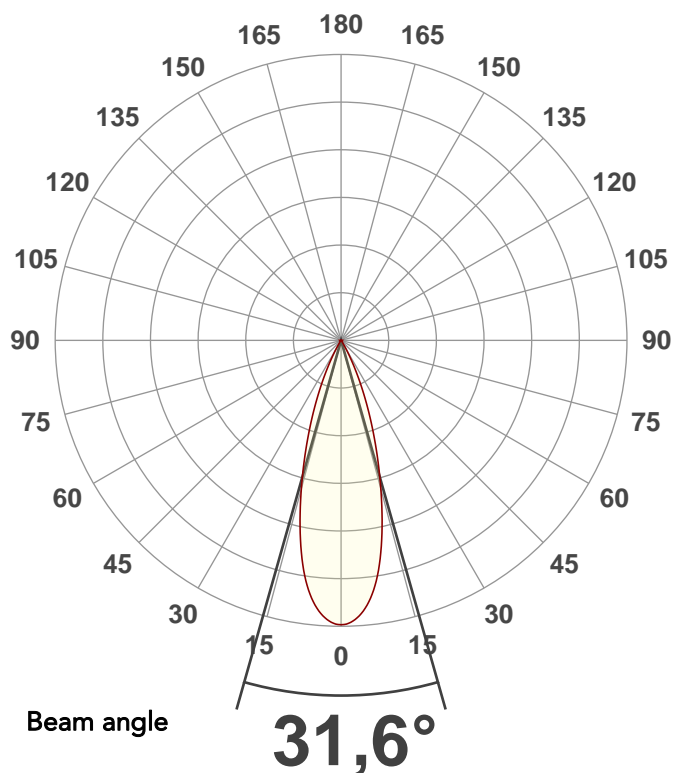

Spectra

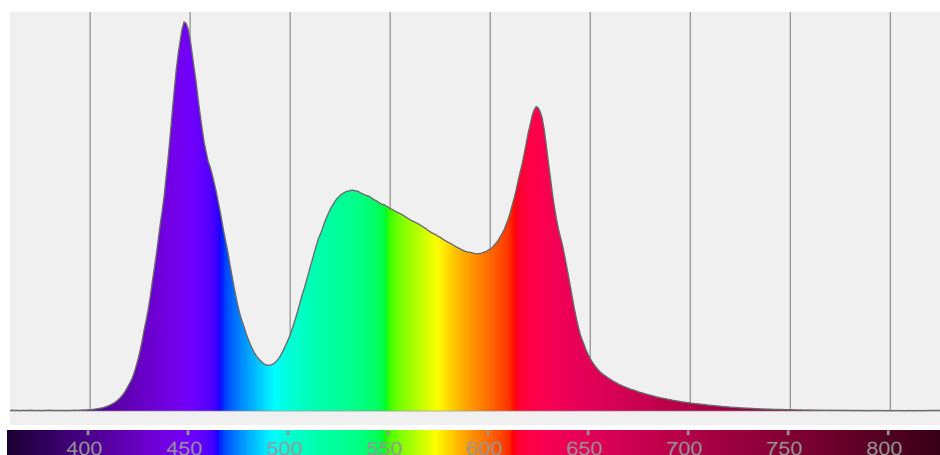

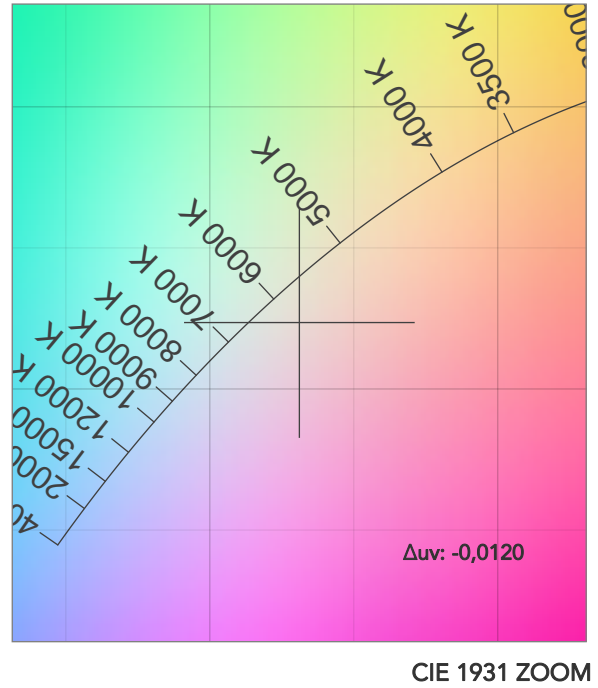
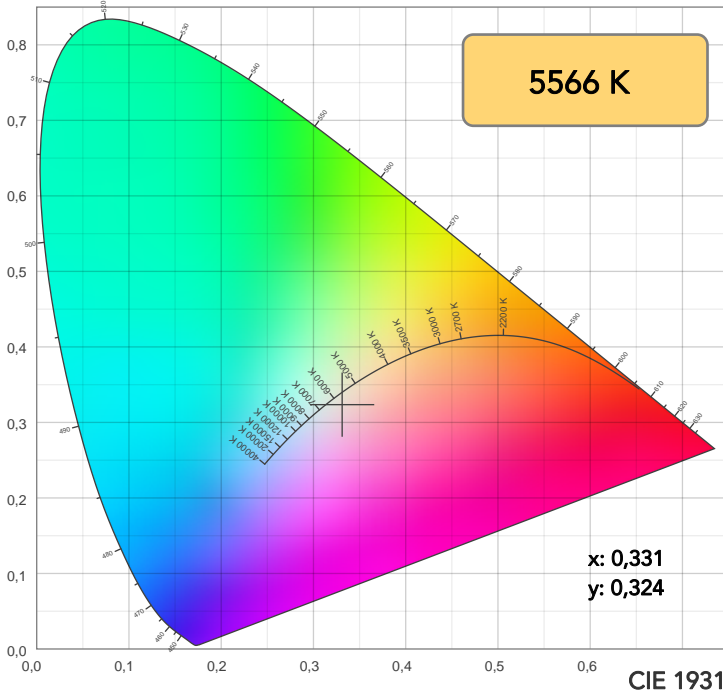

TM30: 81,2

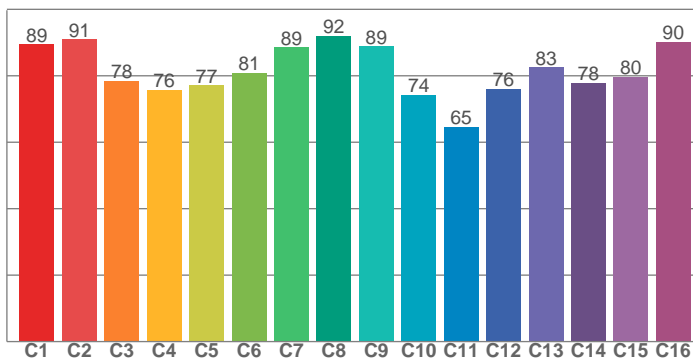

CRI: 89,0 (R1-R8)

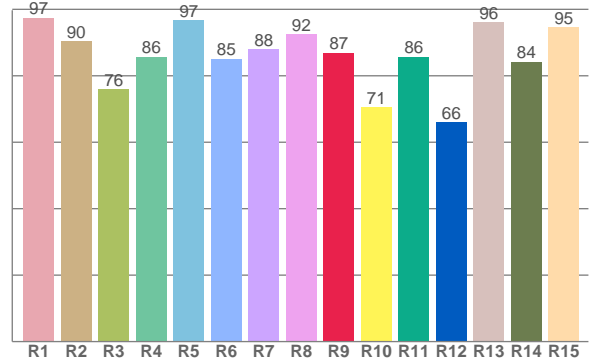

CQS: 83,8

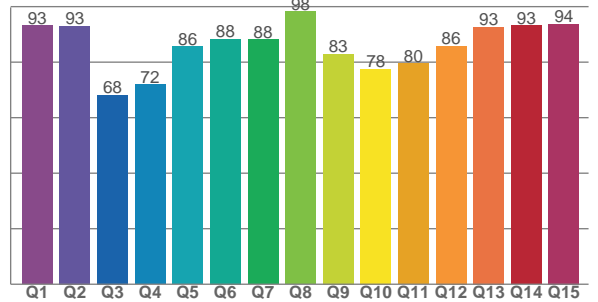

CRI R values, only R1-R8 are used to calculate final CRI value

R1	R2	R3	R4	R5	R6	R7	R8	R9	R10	R11	R12	R13	R14	R15
97,4	90,3	75,9	85,8	96,8	85,1	88,0	92,4	87,0	70,6	85,8	66,1	96,0	84,3	94,7

TM30 C values, 16 binned values out of total of 99 C values

C1	C2	C3	C4	C5	C6	C7	C8	C9	C10	C11	C12	C13	C14	C15	C16
89,5	90,9	78,5	75,8	77,2	80,9	88,5	92,0	88,8	74,2	64,7	76,0	82,5	77,8	79,6	90,2

CQS Q values

Q1	Q2	Q3	Q4	Q5	Q6	Q7	Q8	Q9	Q10	Q11	Q12	Q13	Q14	Q15
93,1	93,0	68,1	71,9	85,6	88,4	88,2	98,3	82,9	77,6	79,5	85,9	92,6	93,1	93,7

COLOR PARAMETERS

Color temperature	Color rendering index	Red component	Color fidelity	Color gamut	Color quality scale	Television lighting index	Color coordinate cie 1931	Color coordinate cie 1931	Color deviation from black body
CCT	CRI	CRI R9	TM30 Rf	TM30 Rg	CQS	TLCI	x	y	$\Delta uv$
5566 K	89,0	87,0	81,2	106,4	83,8	77	0,331	0,324	-0,0120

# TM30 DETAILS

**Rf 81,2**  
Fidelity index Rf

**Rg 106,4**  
Gammut index

Hue Bin	R <sub>f</sub>	Graphic shifts (%)	
		Chroma	Hue
1	89	-4%	-1%
2	91	-2%	3%
3	78	0%	11%
4	76	3%	13%
5	77	8%	10%
6	81	11%	4%
7	89	6%	-3%
8	92	0%	-3%
9	89	-7%	3%
10	74	-7%	12%
11	65	0%	20%
12	76	5%	14%
13	83	11%	7%
14	78	10%	6%
15	80	14%	-8%
16	90	4%	-4%

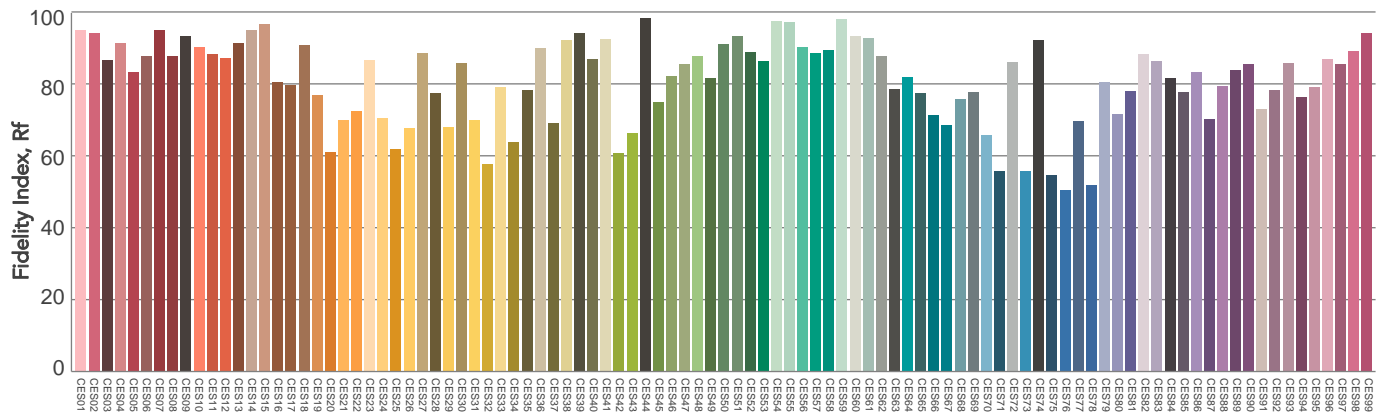
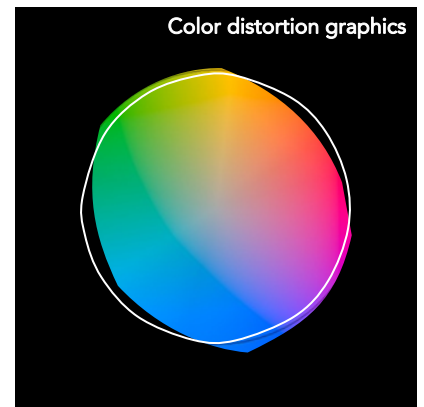
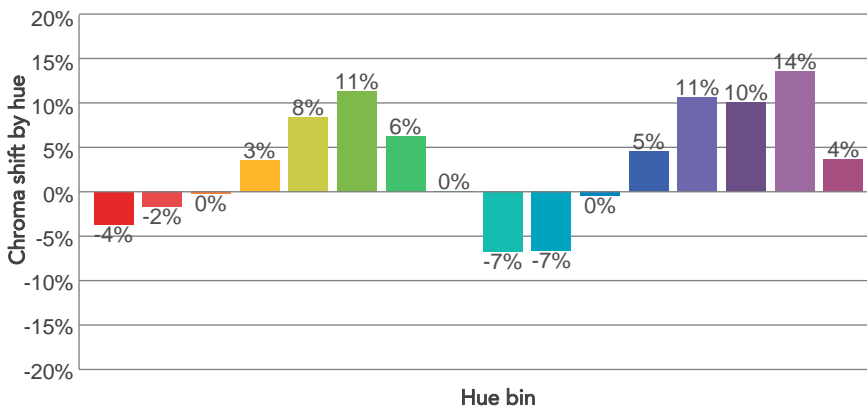
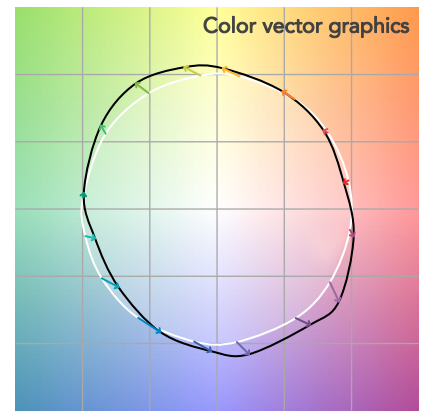
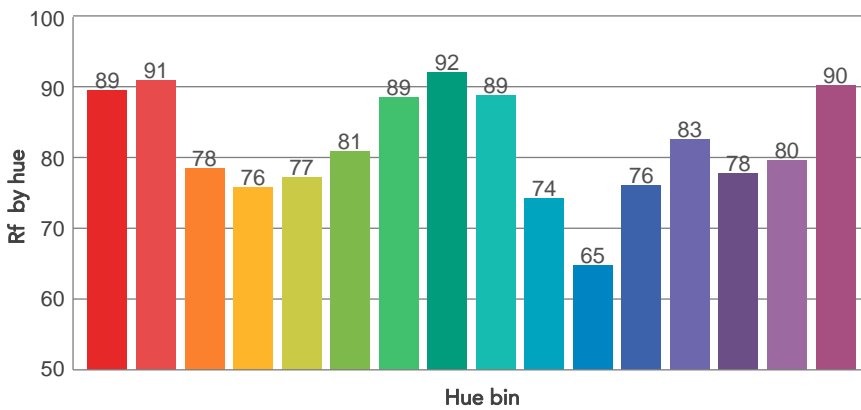
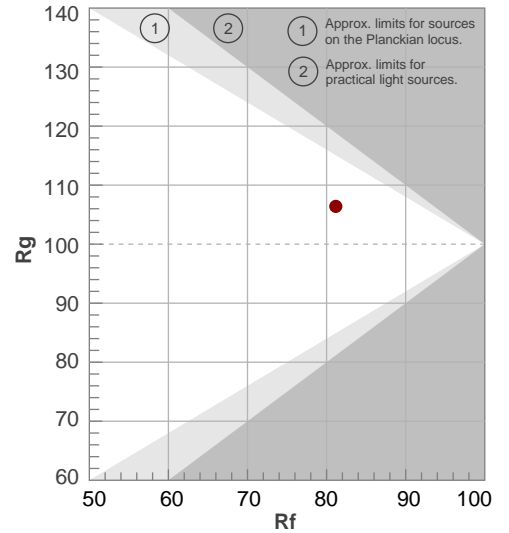

Color Evaluation Sample



# BEAM DETAILS



Beam angle 50%	Field angle 10%	Cutoff angle 2,5%	Intensity ratio in 120° cone	Intensity ratio in 90° cone
31,6°	53,1°	62°	99,4%	98,3%

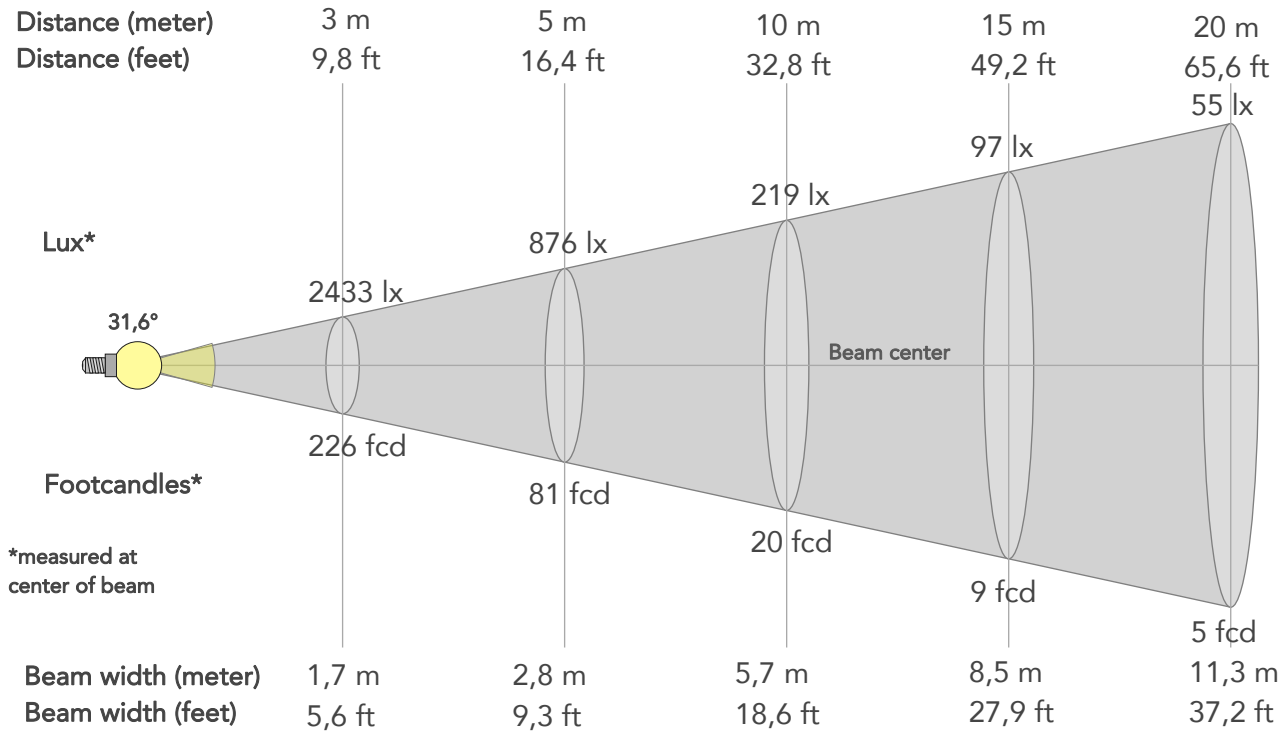

## BEAM INTENSITIES AND WIDTHS

Distance	1m	2m	3m	4m	5m	7,5m	10m	15m	20m	25m	30m	40m	50m
Distance	3,3ft	6,6ft	9,8ft	13,1ft	16,4ft	24,6ft	32,8ft	49,2ft	65,6ft	82ft	98,4ft	131,2ft	164ft
Lux	21900lx	5475lx	2433lx	1369lx	876lx	389lx	219lx	97lx	55lx	35lx	24lx	14lx	9lx
Footcand.	2035fcd	509fcd	226fcd	127fcd	81fcd	36fcd	20fcd	9fcd	5fcd	3fcd	2fcd	1fcd	1fcd
Beam wid.	0,6m	1,1m	1,7m	2,3m	2,8m	4,2m	5,7m	8,5m	11,3m	14,2m	17m	22,7m	28,3m
Beam wid.	1,9ft	3,7ft	5,6ft	7,4ft	9,3ft	13,9ft	18,6ft	27,9ft	37,2ft	46,5ft	55,8ft	74,3ft	92,9ft

## LINEAR DISTRIBUTION DIAGRAM

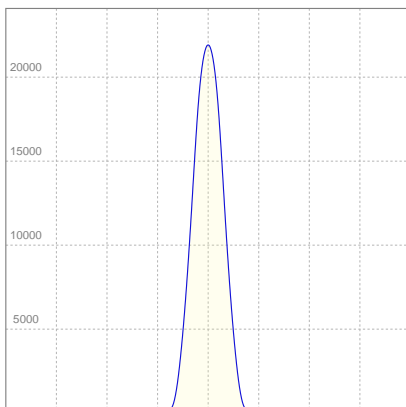

## ELECTRICAL SPECIFICATIONS

Input voltage	Input current	Input power	Effeciency
229V	0,895A	186,3W	37lm/W

## ISO CANDELA DIAGRAM

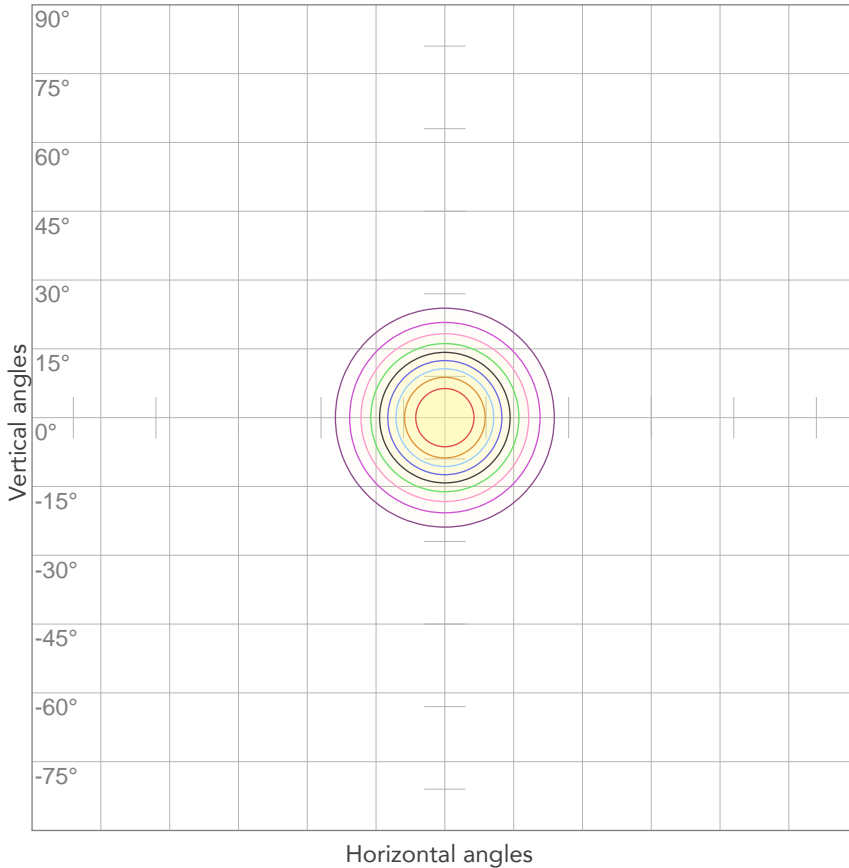

10%	2190 cd
20%	4380 cd
30%	6570 cd
40%	8760 cd
50%	10950 cd
60%	13140 cd
70%	15330 cd
80%	17520 cd

Conditions:

Number of c-planes: 2

Candela at center: 21900 cd

## ISO LUX DIAGRAM

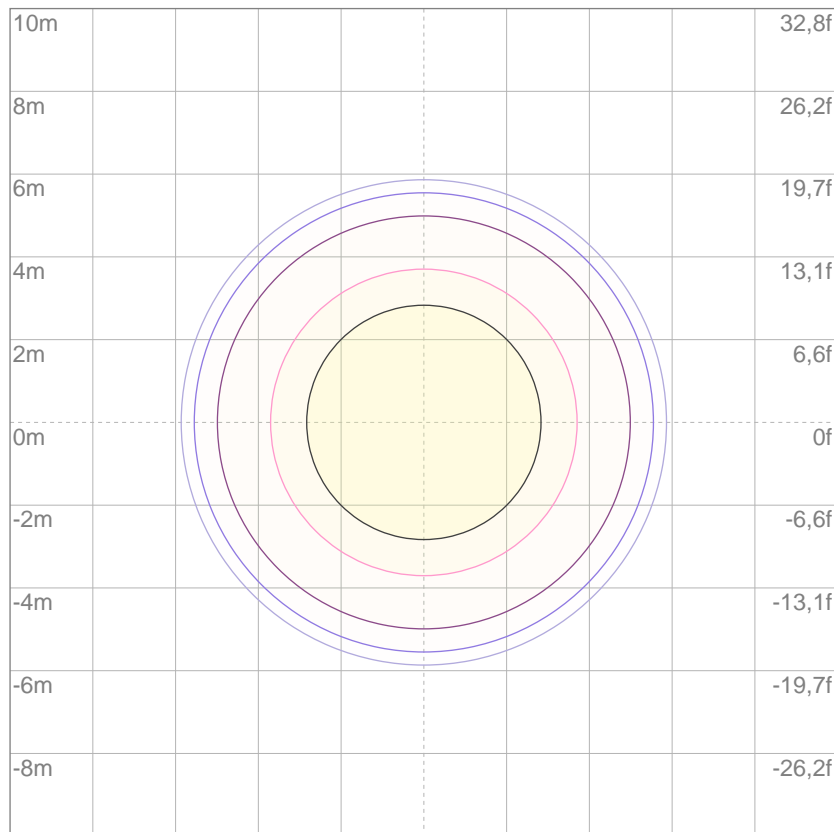

3%	6,57 lx
5%	10,9 lx
10%	21,9 lx
30%	65,7 lx
50%	109 lx

Conditions:

Number of c-planes: 2

Lux at center: 219 lx

*Lux distribution on a surface when lamp is mounted at 10 meters from the surface.*

Mounting height: 10 meters (33 feet)



Total lumen output:

4280 lm

Total candela output:

38540 cd

Light quality:

CRI: 88,9

Color temperature:

5417 K

## PRODUCT NAME:

EclipseFresnel TW

## MEASUREMENT CONDITIONS:

Beam angle:

15°

Target:

5600K

Operator:

Marco Marrocco

Date and time:

14/12/2019 11:19:18

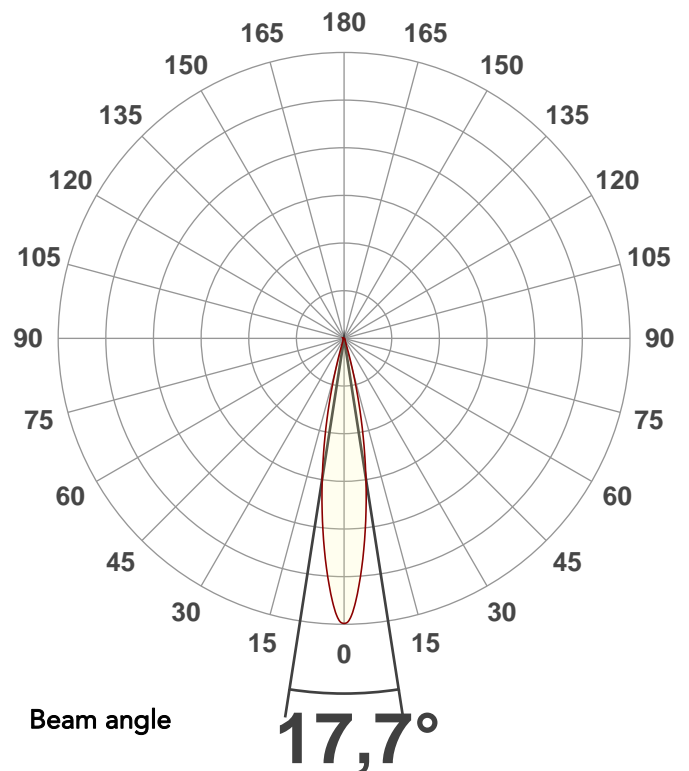

Spectra

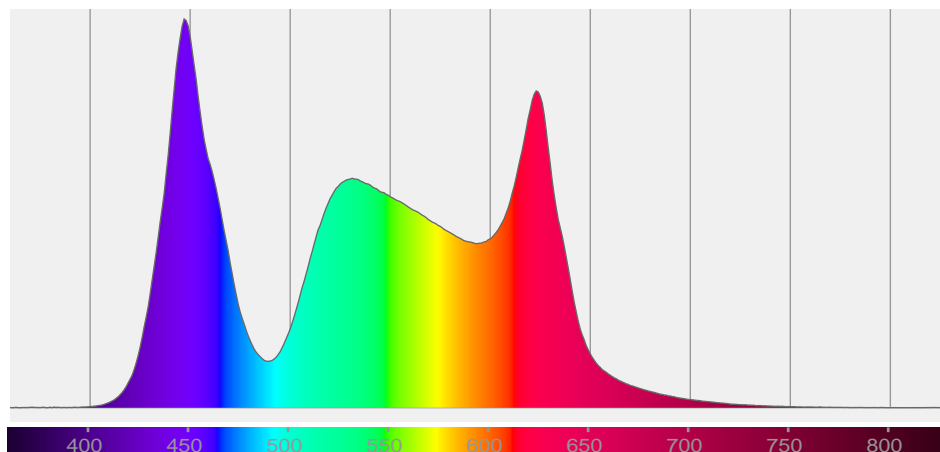

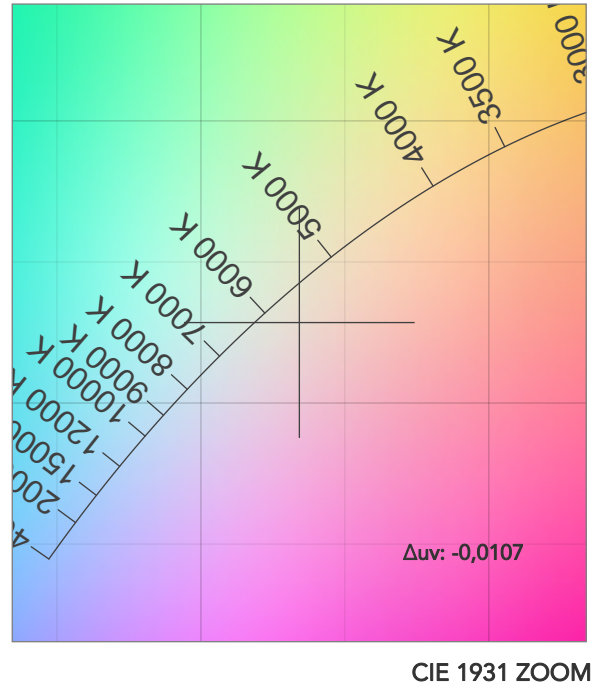
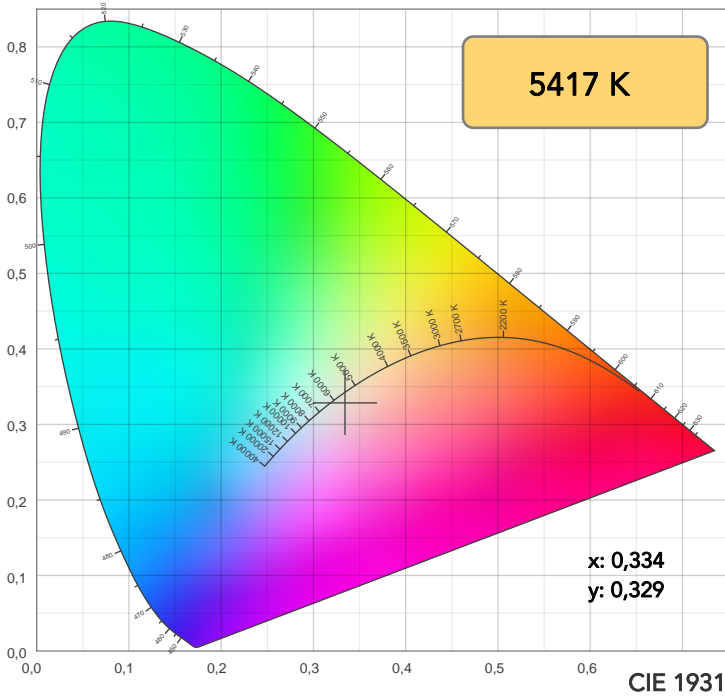

TM30: 81,8

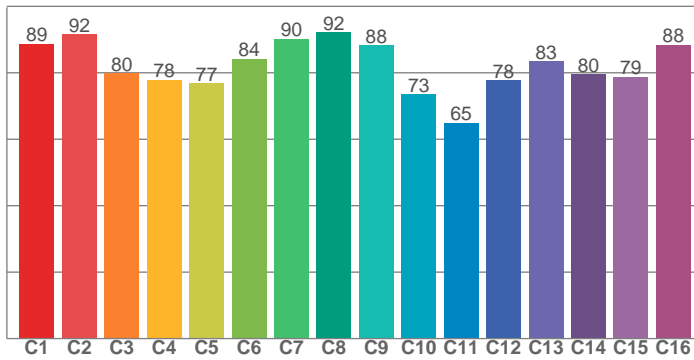

CRI: 88,9 (R1-R8)

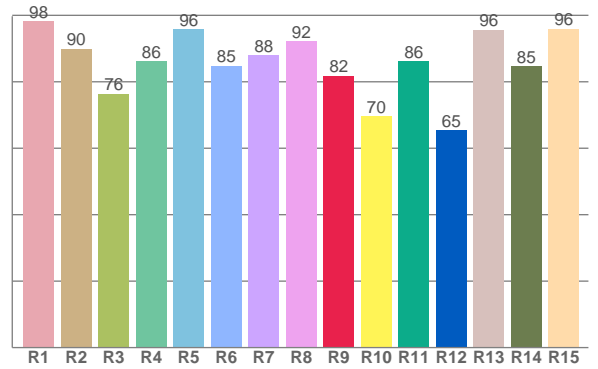

CRI R values, only R1-R8 are used to calculate final CRI value

R1	R2	R3	R4	R5	R6	R7	R8	R9	R10	R11	R12	R13	R14	R15
98,3	89,9	76,4	86,2	95,8	84,9	88,0	92,1	81,8	69,7	86,2	65,5	95,6	84,7	96,0

TM30 C values, 16 binned values out of total of 99 C values

C1	C2	C3	C4	C5	C6	C7	C8	C9	C10	C11	C12	C13	C14	C15	C16
88,6	91,5	79,8	77,8	76,8	84,1	90,2	92,2	88,2	73,4	64,9	77,7	83,4	79,5	78,7	88,5

CQS Q values

Q1	Q2	Q3	Q4	Q5	Q6	Q7	Q8	Q9	Q10	Q11	Q12	Q13	Q14	Q15
92,2	93,3	68,5	72,4	85,5	87,8	87,4	97,8	83,7	77,9	79,9	86,1	92,7	92,2	92,5

CQS: 83,9

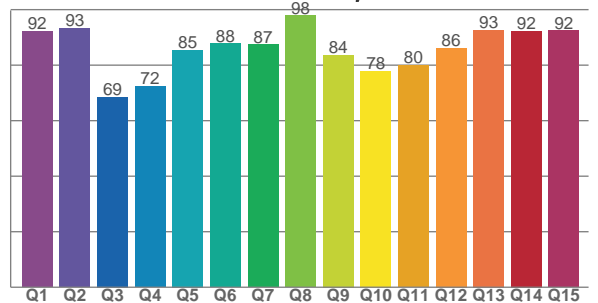

COLOR PARAMETERS

Color temperature	Color rendering index	Red component	Color fidelity	Color gamut	Color quality scale	Television lighting index	Color coordinate cie 1931	Color coordinate cie 1931	Color deviation from black body
CCT	CRI	CRI R9	TM30 Rf	TM30 Rg	CQS	TLCI	x	y	Δuv
5417 K	88,9	81,8	81,8	105,2	83,9	76	0,334	0,329	-0,0107

# TM30 DETAILS

**Rf 81,8**  
Fidelity index Rf

**Rg 105,2**  
Gammut index

Hue Bin	R <sub>f</sub>	Graphic shifts (%)	
		Chroma	Hue
1	89	-4%	-1%
2	92	-2%	3%
3	80	-1%	10%
4	78	3%	12%
5	77	7%	10%
6	84	10%	3%
7	90	5%	-3%
8	92	-1%	-3%
9	88	-7%	4%
10	73	-7%	13%
11	65	0%	20%
12	78	5%	13%
13	83	10%	6%
14	80	9%	5%
15	79	13%	-10%
16	88	4%	-6%

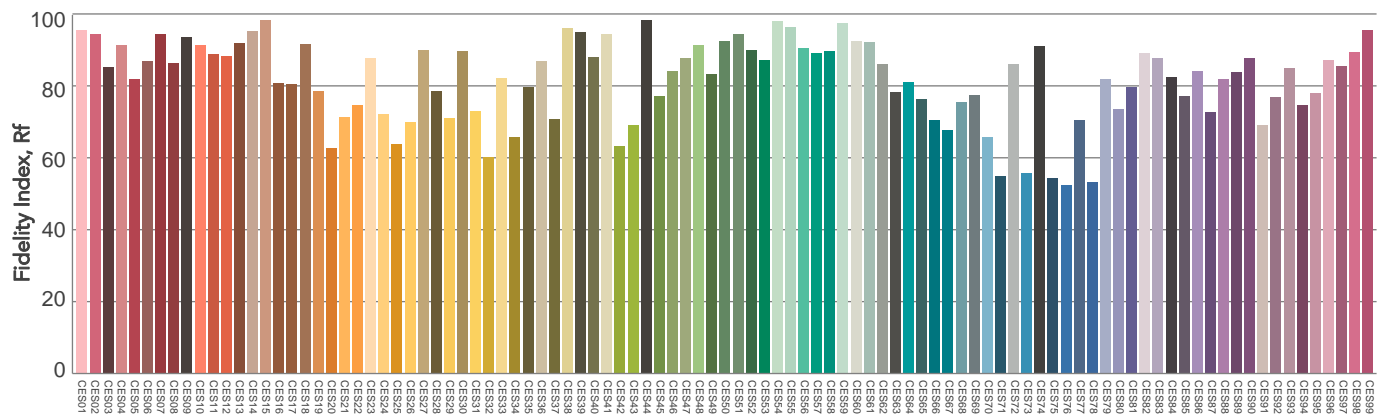
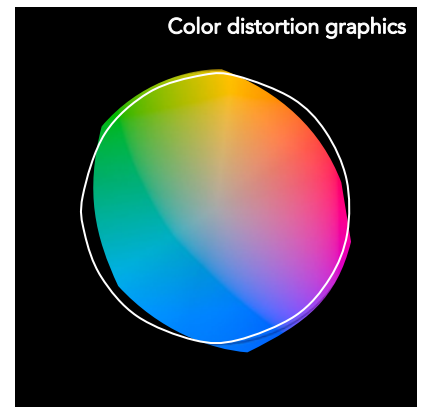
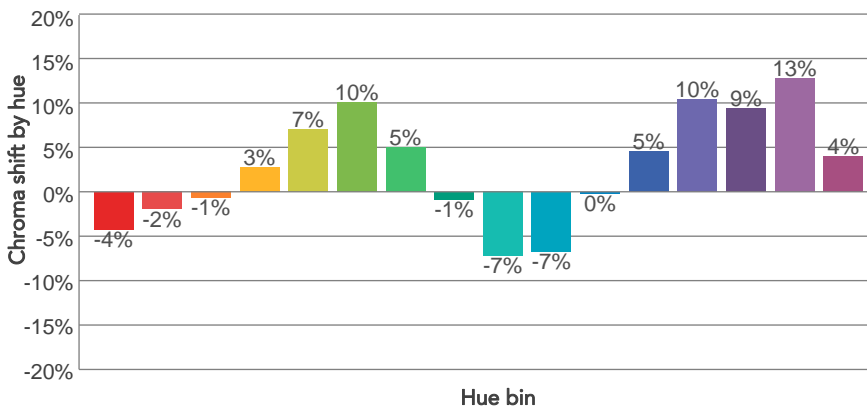
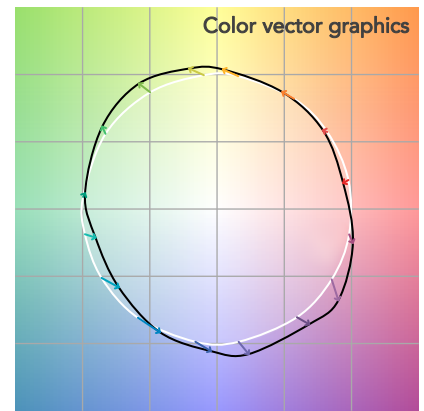
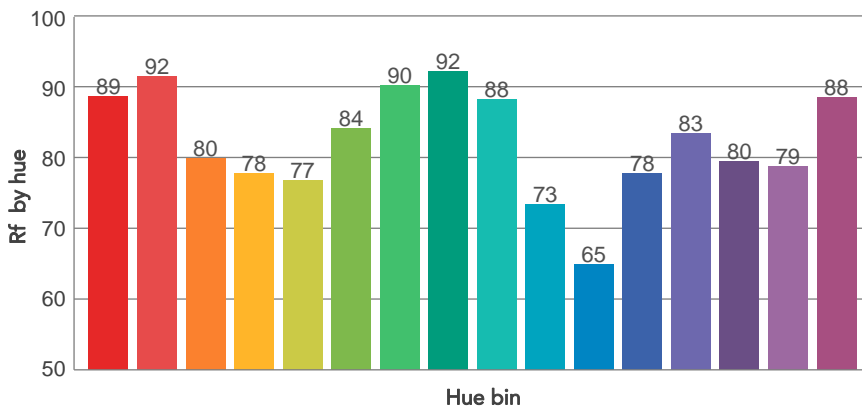
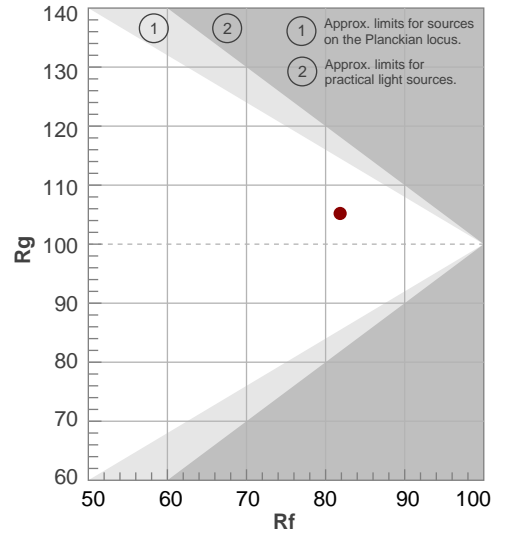

Color Evaluation Sample

# BEAM DETAILS



Beam angle 50%	Field angle 10%	Cutoff angle 2,5%	Intensity ratio in 120° cone	Intensity ratio in 90° cone
17,7°	30,9°	38,1°	99,4%	98,0%

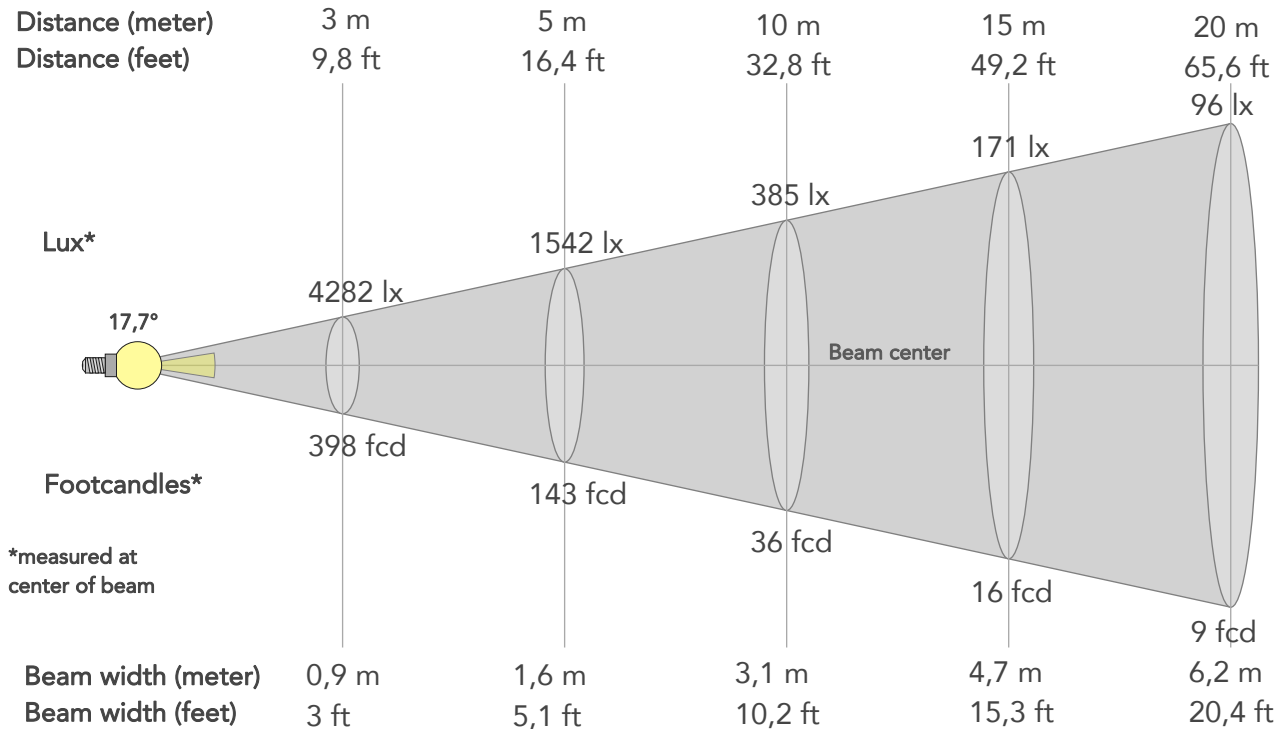

## BEAM INTENSITIES AND WIDTHS

Distance	1m	2m	3m	4m	5m	7,5m	10m	15m	20m	25m	30m	40m	50m
Distance	3,3ft	6,6ft	9,8ft	13,1ft	16,4ft	24,6ft	32,8ft	49,2ft	65,6ft	82ft	98,4ft	131,2ft	164ft
Lux	38540lx	9635lx	4282lx	2409lx	1542lx	685lx	385lx	171lx	96lx	62lx	43lx	24lx	15lx
Footcand.	3580fcd	895fcd	398fcd	224fcd	143fcd	64fcd	36fcd	16fcd	9fcd	6fcd	4fcd	2fcd	1fcd
Beam wid.	0,3m	0,6m	0,9m	1,2m	1,6m	2,3m	3,1m	4,7m	6,2m	7,8m	9,3m	12,4m	15,6m
Beam wid.	1ft	2,1ft	3ft	4,1ft	5,1ft	7,7ft	10,2ft	15,3ft	20,4ft	25,5ft	30,6ft	40,8ft	51ft

## LINEAR DISTRIBUTION DIAGRAM

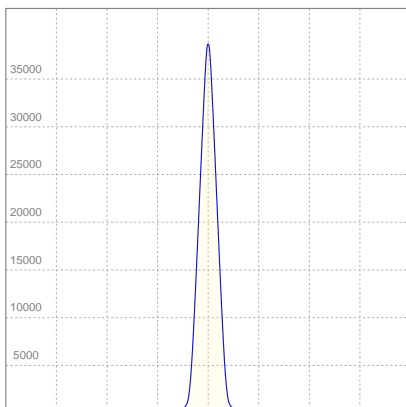

## ELECTRICAL SPECIFICATIONS

Input voltage	Input current	Input power	Effeciency
227V	0,889A	183,7W	23lm/W

## ISO CANDELA DIAGRAM

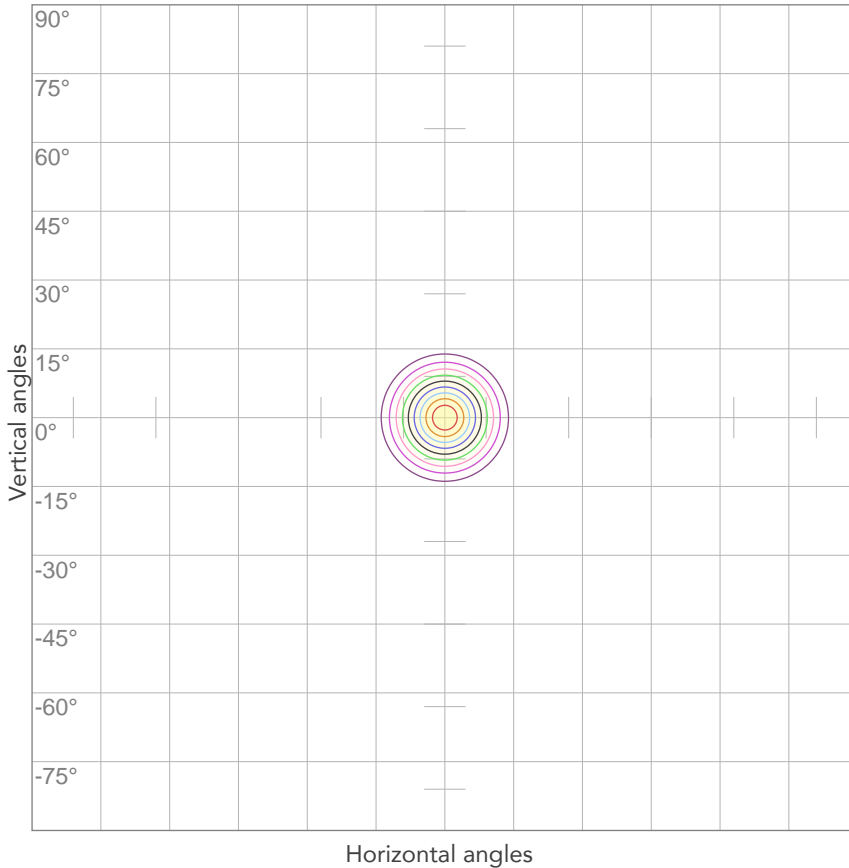

10%	3854 cd
20%	7708 cd
30%	11562 cd
40%	15416 cd
50%	19270 cd
60%	23124 cd
70%	26978 cd
80%	30832 cd

Conditions:

Number of c-planes: 2

Candela at center: 38540 cd

## ISO LUX DIAGRAM

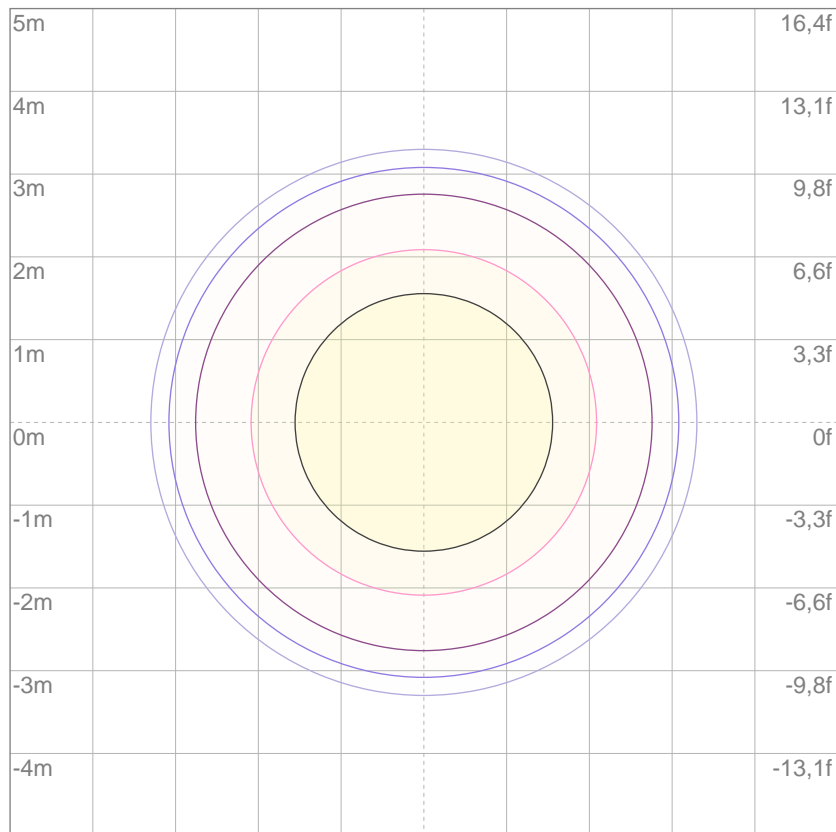

3%	11,6 lx
5%	19,3 lx
10%	38,5 lx
30%	116 lx
50%	193 lx

Conditions:

Number of c-planes: 2

Lux at center: 385 lx

*Lux distribution on a surface when lamp is mounted at 10 meters from the surface.*

Mounting height: 10 meters (33 feet)



Total lumen output:

7417 lm

Total candela output:

8106 cd

Light quality:

CRI: 88,7

Color temperature:

5956 K

## PRODUCT NAME:

EclipseFresnel TW

## MEASUREMENT CONDITIONS:

Beam angle:

45°

Target:

6000K

Operator:

Marco Marrocco

Date and time:

14/12/2019 10:54:07

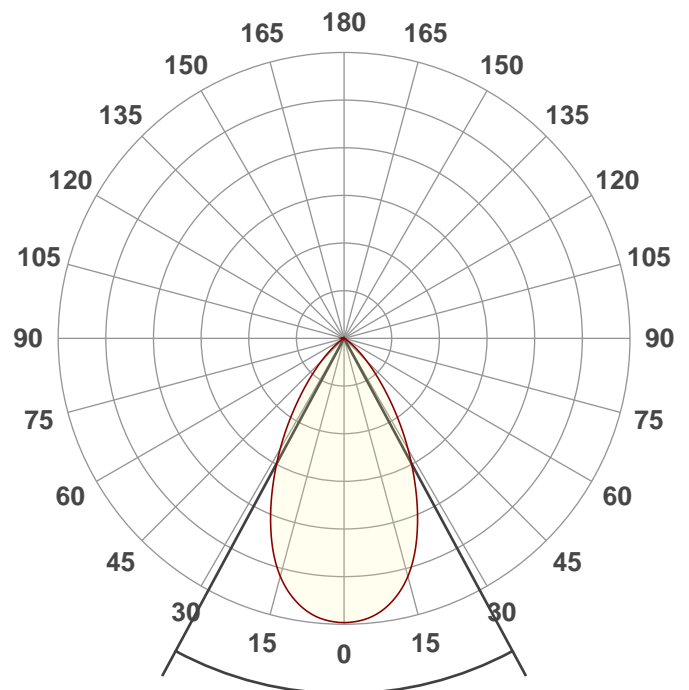

Beam angle

56,6°

Spectra

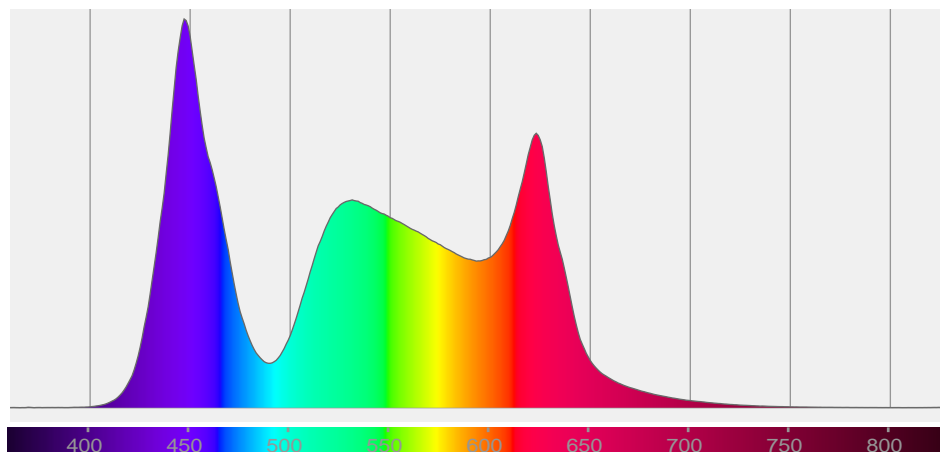



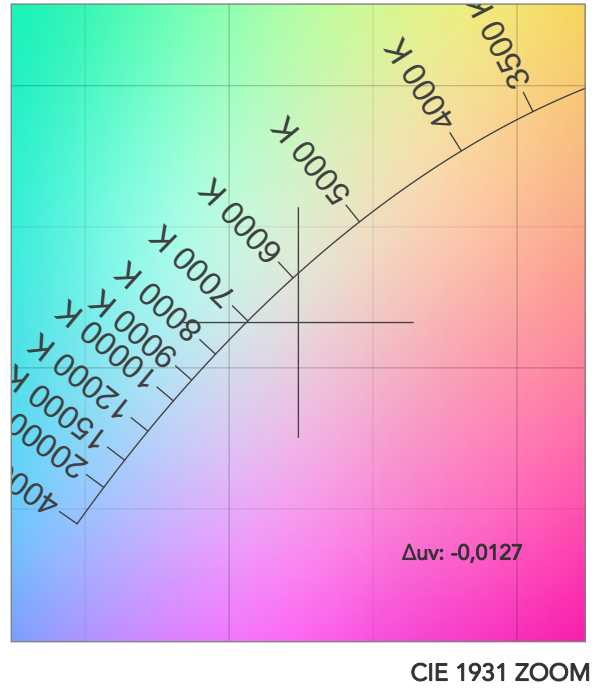
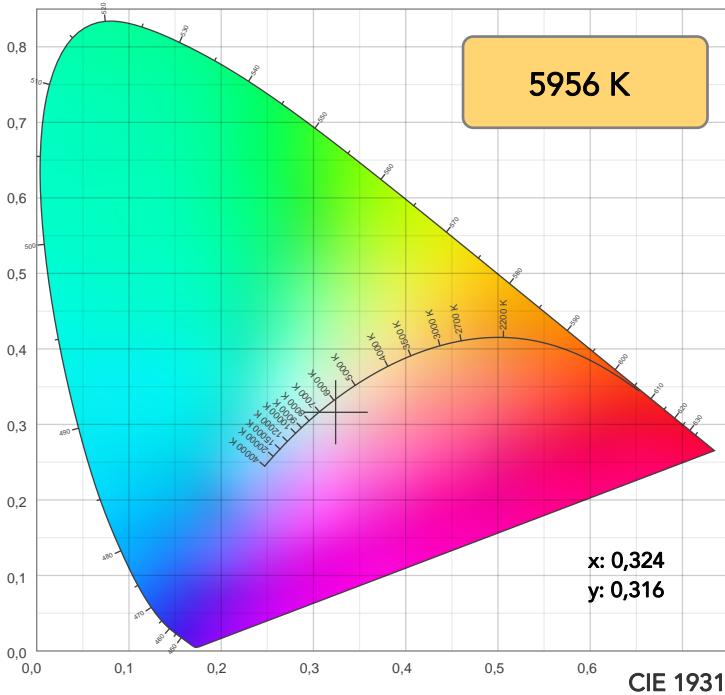

TM30: 80,8

CRI: 88,7 (R1-R8)

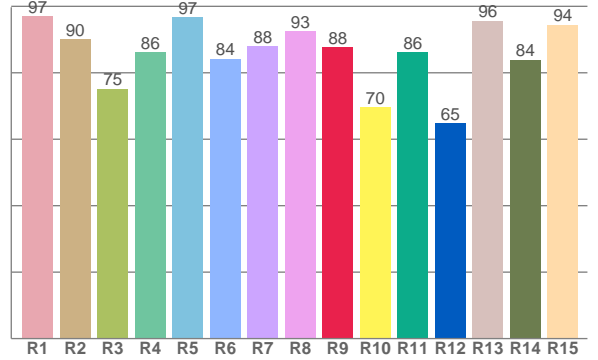
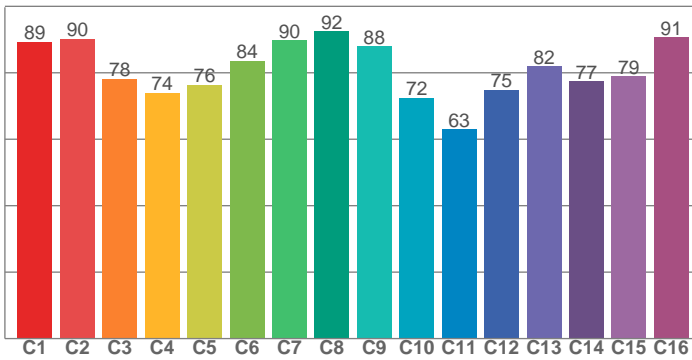

CRI R values, only R1-R8 are used to calculate final CRI value

R1	R2	R3	R4	R5	R6	R7	R8	R9	R10	R11	R12	R13	R14	R15
96,9	90,0	75,2	86,1	96,7	84,3	88,0	92,5	87,6	69,7	86,1	64,8	95,7	83,9	94,4

TM30 C values, 16 binned values out of total of 99 C values

C1	C2	C3	C4	C5	C6	C7	C8	C9	C10	C11	C12	C13	C14	C15	C16
89,3	90,2	78,2	73,9	76,4	83,6	89,7	92,5	88,0	72,4	63,0	74,9	81,9	77,4	78,9	90,7

CQS Q values

Q1	Q2	Q3	Q4	Q5	Q6	Q7	Q8	Q9	Q10	Q11	Q12	Q13	Q14	Q15
93,7	92,7	67,6	70,1	84,5	89,2	89,1	98,4	82,2	76,9	78,3	84,6	91,6	92,9	94,0

CQS: 83,2

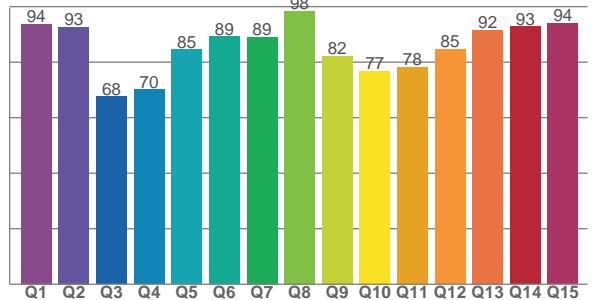

COLOR PARAMETERS

Color temperature	Color rendering index	Red component	Color fidelity	Color gamut	Color quality scale	Television lighting index	Color coordinate cie 1931	Color coordinate cie 1931	Color deviation from black body
CCT	CRI	CRI R9	TM30 Rf	TM30 Rg	CQS	TLCI	x	y	Δuv
5956 K	88,7	87,6	80,8	106,1	83,2	77	0,324	0,316	-0,0127

# TM30 DETAILS

**Rf 80,8**  
Fidelity index Rf

**Rg 106,1**  
Gammut index

Hue Bin	R <sub>f</sub>	Graphic shifts (%)	
		Chroma	Hue
1	89	-4%	-1%
2	90	-2%	3%
3	78	0%	11%
4	74	3%	14%
5	76	8%	10%
6	84	10%	4%
7	90	6%	-3%
8	92	0%	-2%
9	88	-7%	4%
10	72	-7%	14%
11	63	0%	21%
12	75	5%	14%
13	82	11%	8%
14	77	10%	7%
15	79	15%	-8%
16	91	4%	-4%

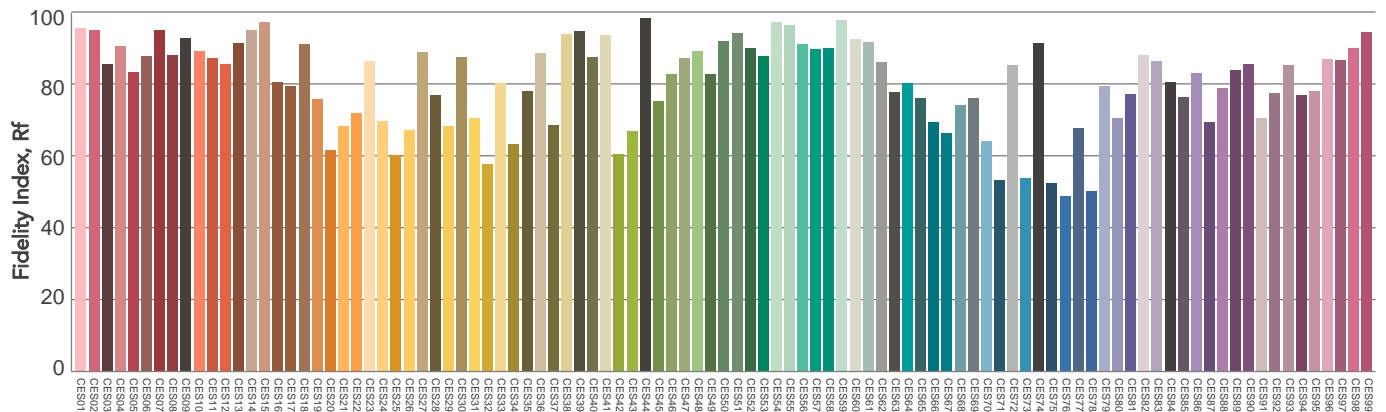
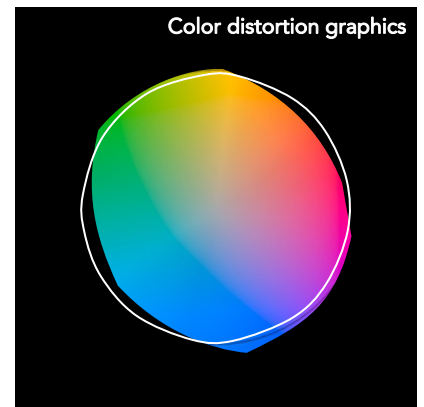
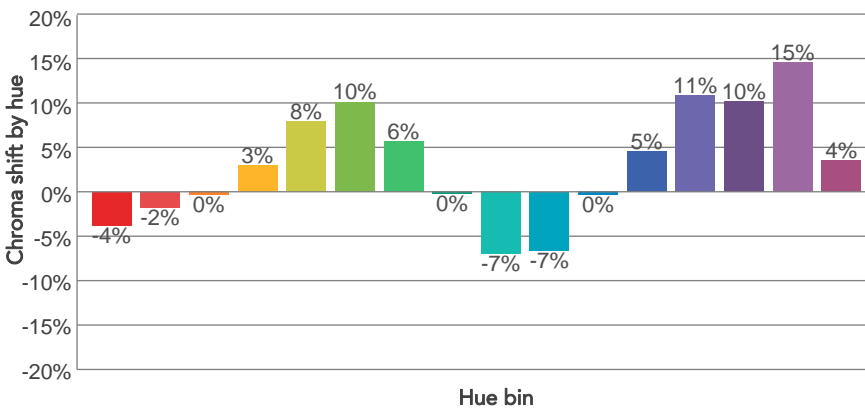
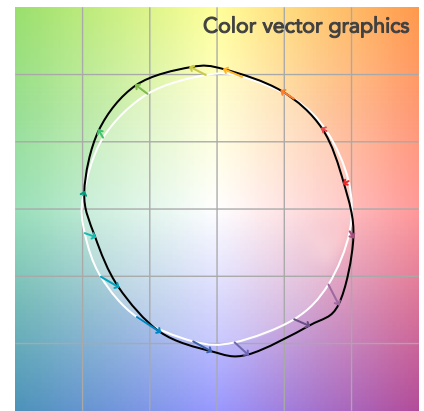
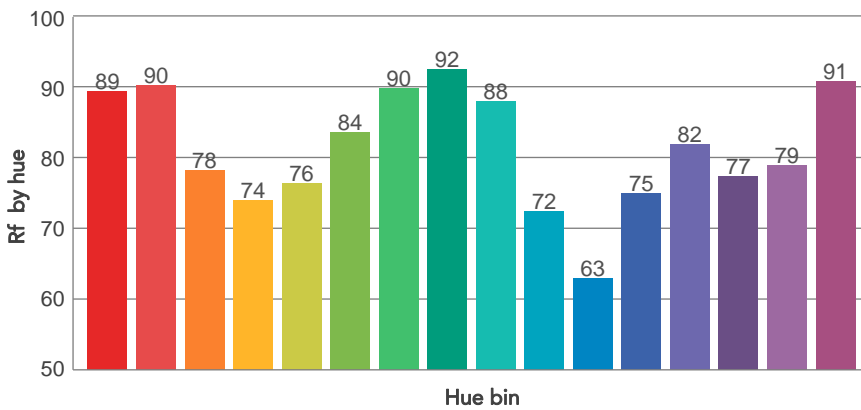
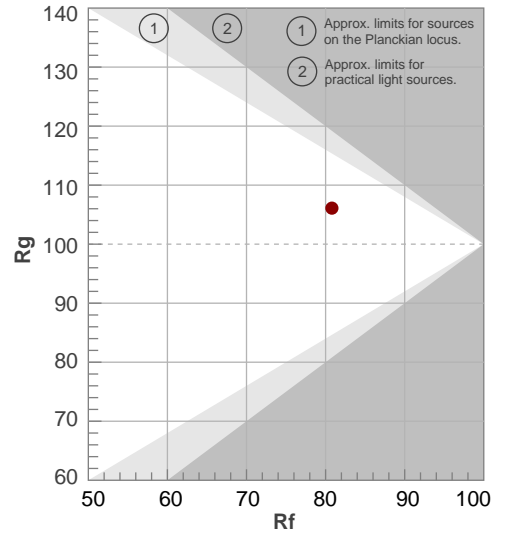

Color Evaluation Sample

# BEAM DETAILS



Beam angle 50%	Field angle 10%	Cutoff angle 2,5%	Intensity ratio in 120° cone	Intensity ratio in 90° cone
56,6°	91,8°	108,1°	99,5%	93,6%

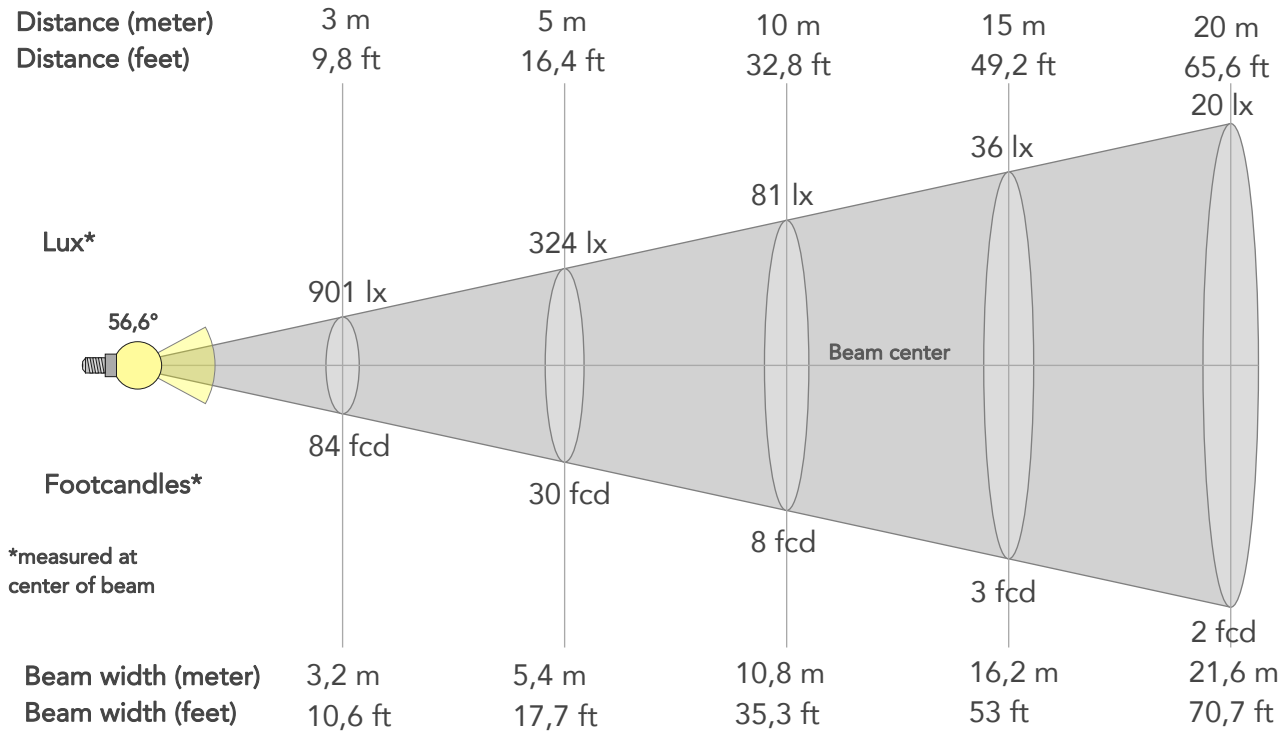

## BEAM INTENSITIES AND WIDTHS

Distance	1m	2m	3m	4m	5m	7,5m	10m	15m	20m	25m	30m	40m	50m
Distance	3,3ft	6,6ft	9,8ft	13,1ft	16,4ft	24,6ft	32,8ft	49,2ft	65,6ft	82ft	98,4ft	131,2ft	164ft
Lux	8106lx	2026lx	901lx	507lx	324lx	144lx	81lx	36lx	20lx	13lx	9lx	5lx	3lx
Footcand.	753fcd	188fcd	84fcd	47fcd	30fcd	13fcd	8fcd	3fcd	2fcd	1fcd	1fcd	0fcd	0fcd
Beam wid.	1,1m	2,2m	3,2m	4,3m	5,4m	8,1m	10,8m	16,2m	21,6m	26,9m	32,3m	43,1m	53,9m
Beam wid.	3,6ft	7,1ft	10,6ft	14,1ft	17,7ft	26,5ft	35,3ft	53ft	70,7ft	88,4ft	106ft	141,4ft	176,7ft

## LINEAR DISTRIBUTION DIAGRAM

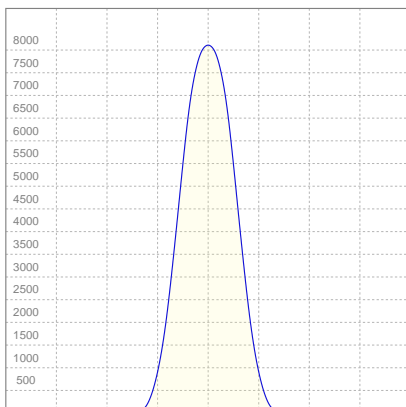

## ELECTRICAL SPECIFICATIONS

Input voltage	Input current	Input power	Effeciency
227V	0,909A	188,1W	39lm/W

## ISO CANDELA DIAGRAM

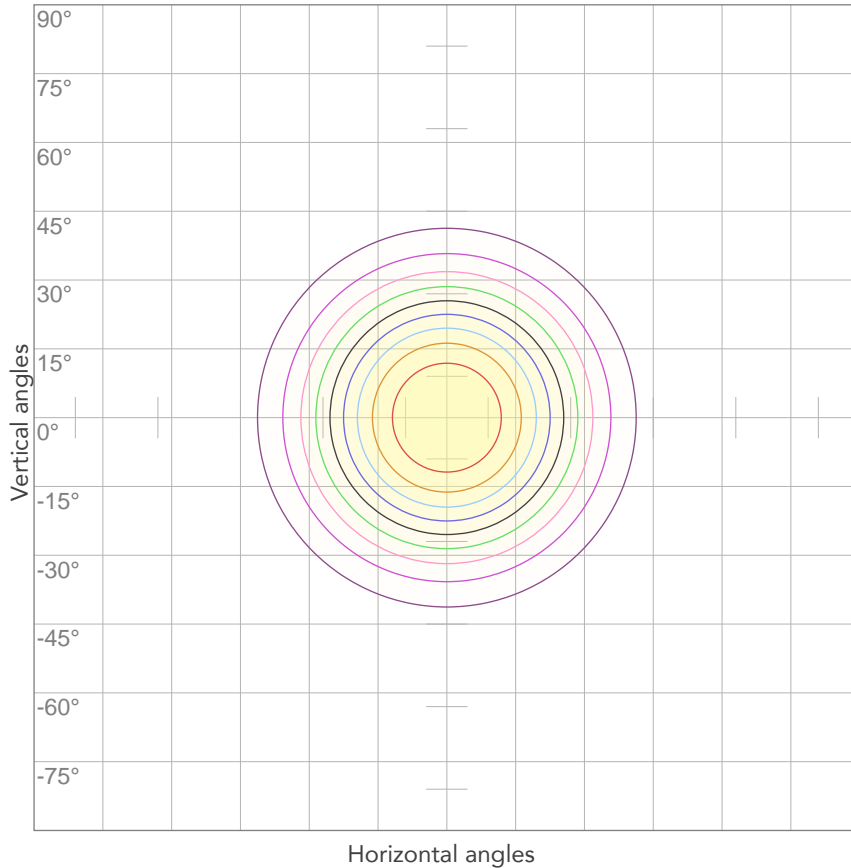

10%	811 cd
20%	1621 cd
30%	2432 cd
40%	3242 cd
50%	4053 cd
60%	4864 cd
70%	5674 cd
80%	6485 cd

Conditions:

Number of c-planes: 2

Candela at center: 8106 cd

## ISO LUX DIAGRAM

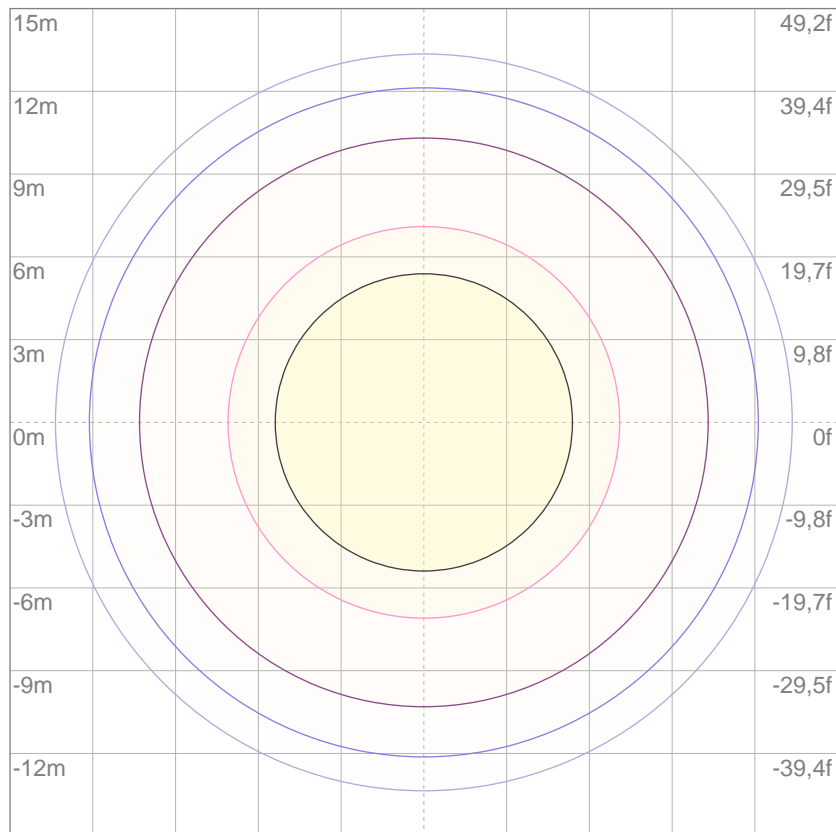

3%	2,43 lx
5%	4,05 lx
10%	8,11 lx
30%	24,3 lx
50%	40,5 lx

Conditions:

Number of c-planes: 2

Lux at center: 81,1 lx

*Lux distribution on a surface when lamp is mounted at 10 meters from the surface.*

Mounting height: 10 meters (33 feet)



Total lumen output:

6819 lm

Total candela output:

21805 cd

Light quality:

CRI: 88,8

Color temperature:

5931 K

## PRODUCT NAME:

EclipseFresnel TW

## MEASUREMENT CONDITIONS:

Beam angle:  
30°

Target:  
6000K

Operator:  
Marco Marrocco

Date and time:  
14/12/2019 12:01:17

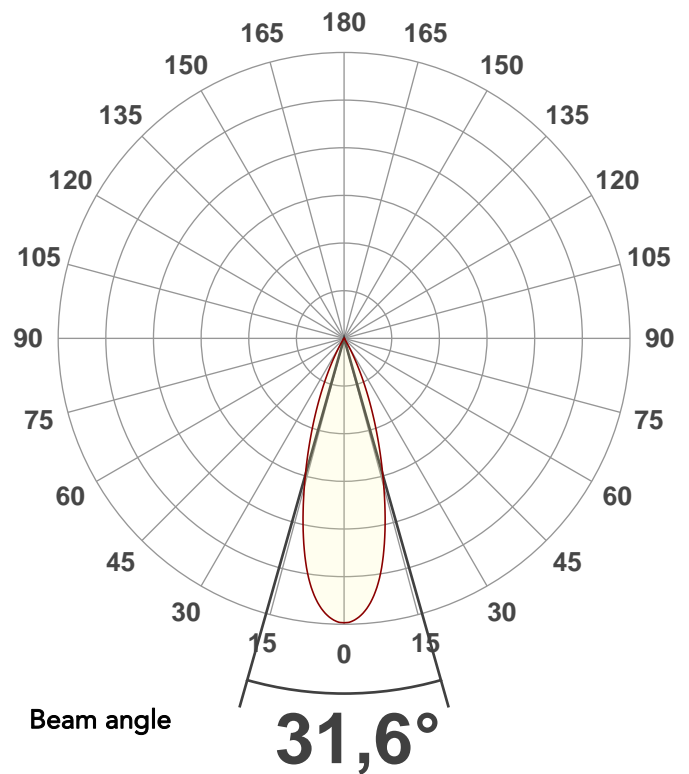

Spectra

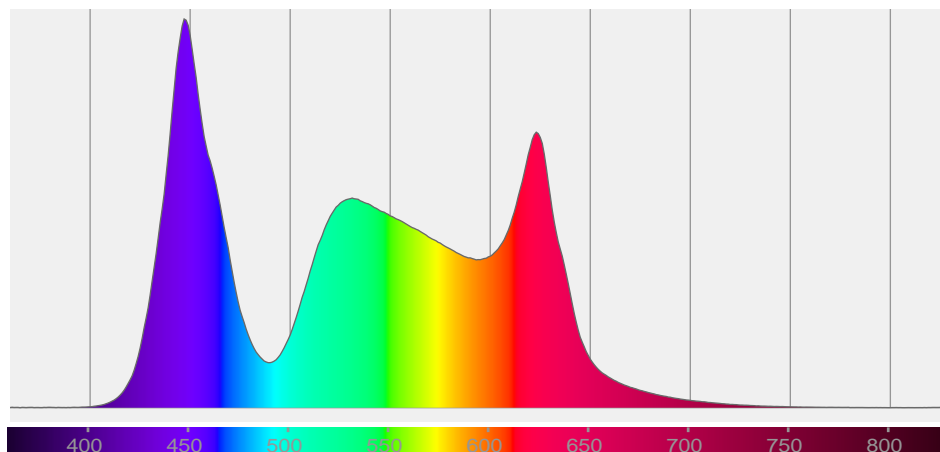

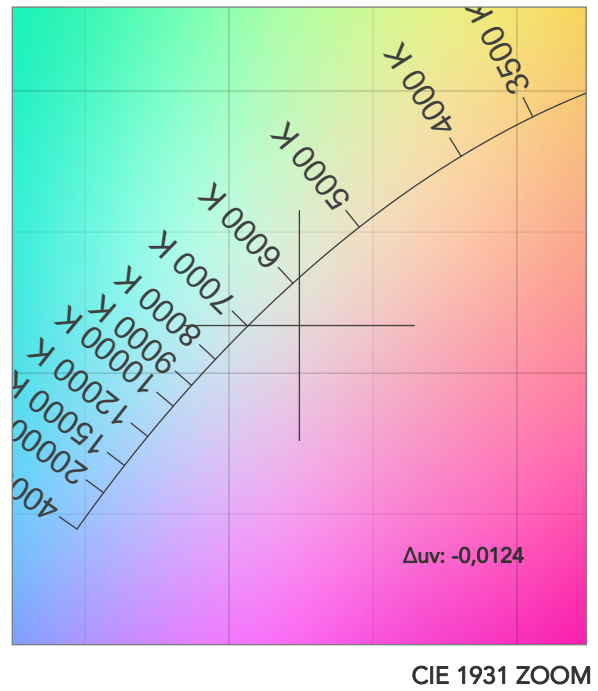
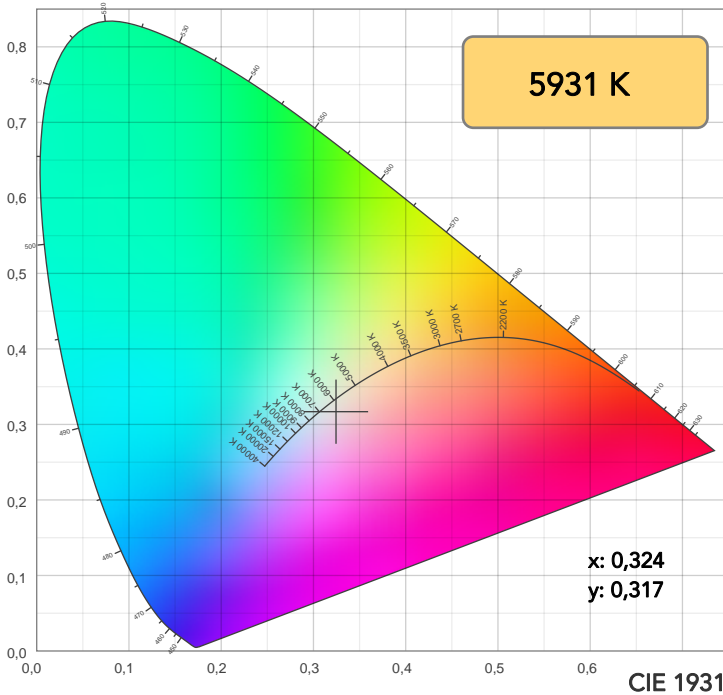

TM30: 80,9

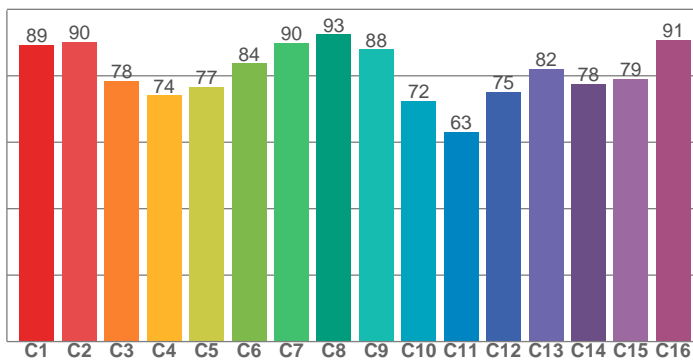

CRI: 88,8 (R1-R8)

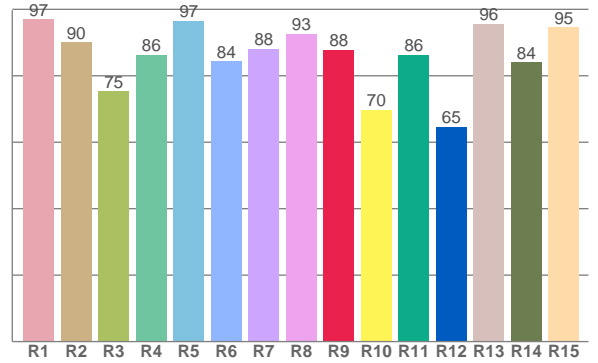

CQS: 83,3

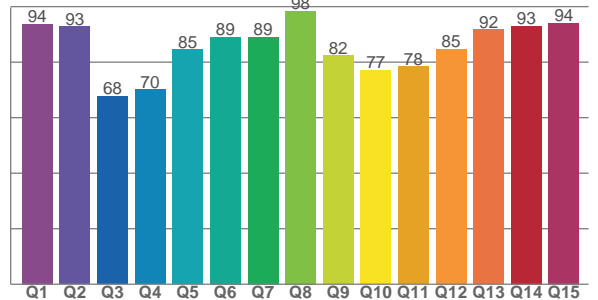

CRI R values, only R1-R8 are used to calculate final CRI value

R1	R2	R3	R4	R5	R6	R7	R8	R9	R10	R11	R12	R13	R14	R15
97,1	90,1	75,3	86,3	96,6	84,3	88,1	92,6	87,8	69,8	86,3	64,7	95,7	84,0	94,6

TM30 C values, 16 binned values out of total of 99 C values

C1	C2	C3	C4	C5	C6	C7	C8	C9	C10	C11	C12	C13	C14	C15	C16
89,4	90,3	78,4	74,1	76,6	83,8	89,9	92,5	88,0	72,4	63,2	75,1	82,0	77,6	79,0	90,8

CQS Q values

Q1	Q2	Q3	Q4	Q5	Q6	Q7	Q8	Q9	Q10	Q11	Q12	Q13	Q14	Q15
93,8	92,9	67,7	70,2	84,5	89,1	89,0	98,4	82,4	77,0	78,4	84,8	91,7	93,0	94,1

COLOR PARAMETERS

Color temperature	Color rendering index	Red component	Color fidelity	Color gamut	Color quality scale	Television lighting index	Color coordinate cie 1931	Color coordinate cie 1931	Color deviation from black body
CCT	CRI	CRI R9	TM30 Rf	TM30 Rg	CQS	TLCI	x	y	Δuv
5931 K	88,8	87,8	80,9	106,0	83,3	77	0,324	0,317	-0,0124

# TM30 DETAILS

**Rf 80,9**  
Fidelity index Rf

**Rg 106,0**  
Gammut index

Hue Bin	R <sub>f</sub>	Graphic shifts (%)	
		Chroma	Hue
1	89	-4%	-1%
2	90	-2%	3%
3	78	0%	11%
4	74	3%	14%
5	77	8%	10%
6	84	10%	4%
7	90	6%	-3%
8	93	0%	-2%
9	88	-7%	4%
10	72	-7%	14%
11	63	0%	20%
12	75	5%	14%
13	82	11%	8%
14	78	10%	6%
15	79	14%	-8%
16	91	4%	-4%

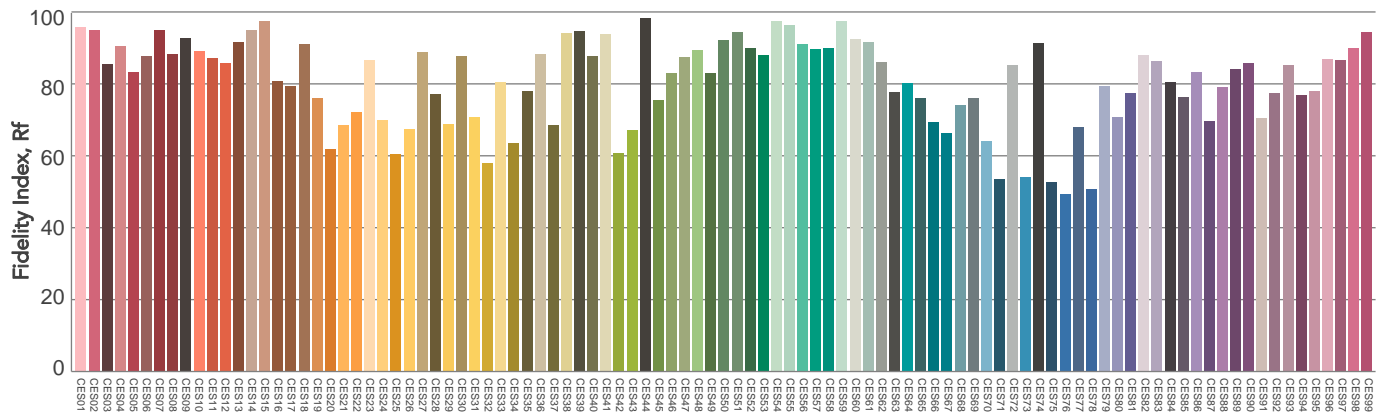
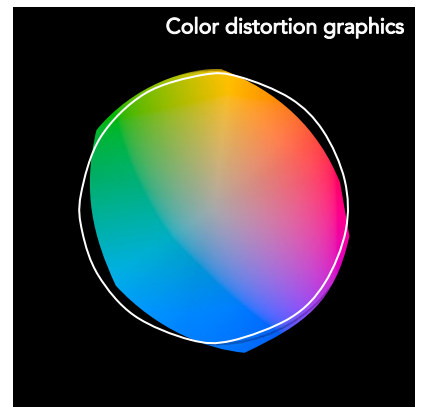
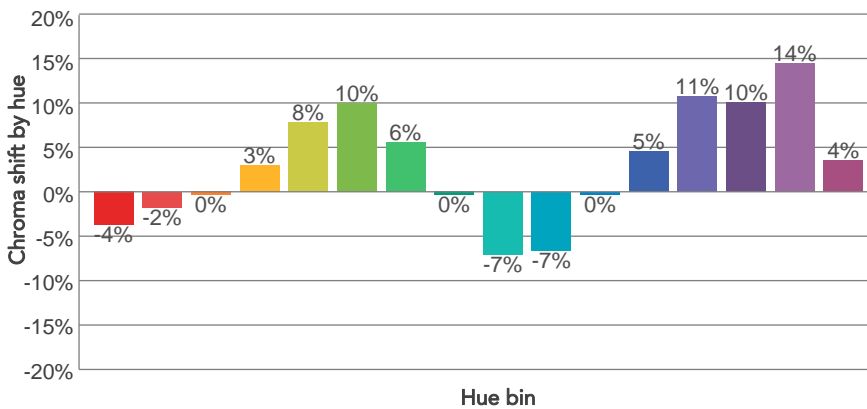
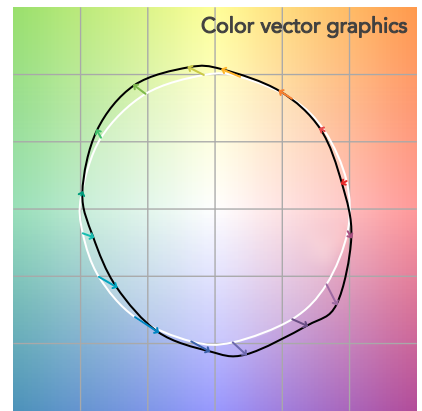
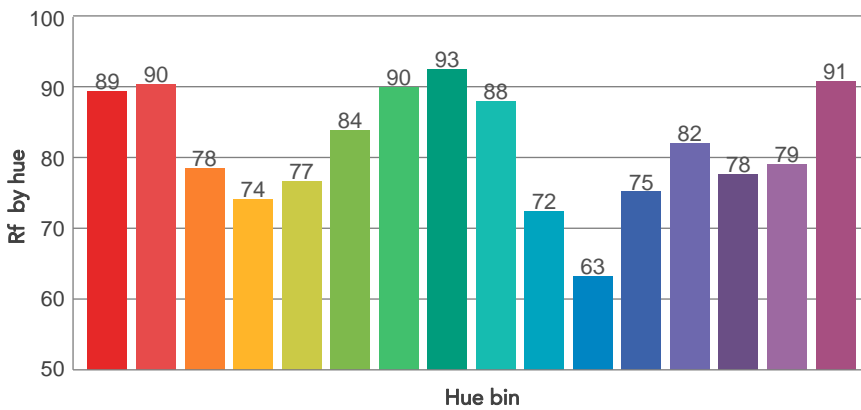
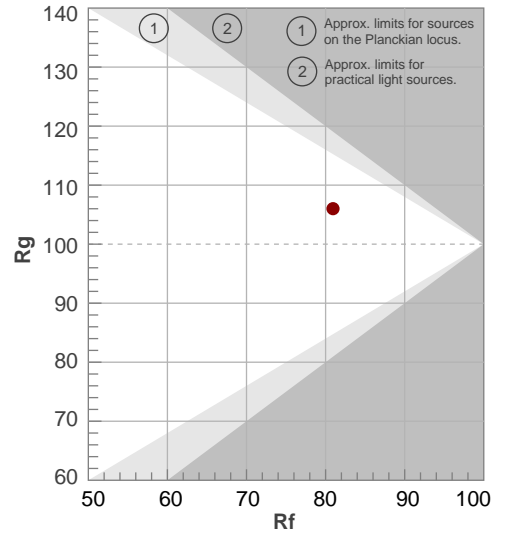

Color Evaluation Sample

# BEAM DETAILS



Beam angle 50%	Field angle 10%	Cutoff angle 2,5%	Intensity ratio in 120° cone	Intensity ratio in 90° cone
31,6°	53,1°	62°	99,4%	98,3%

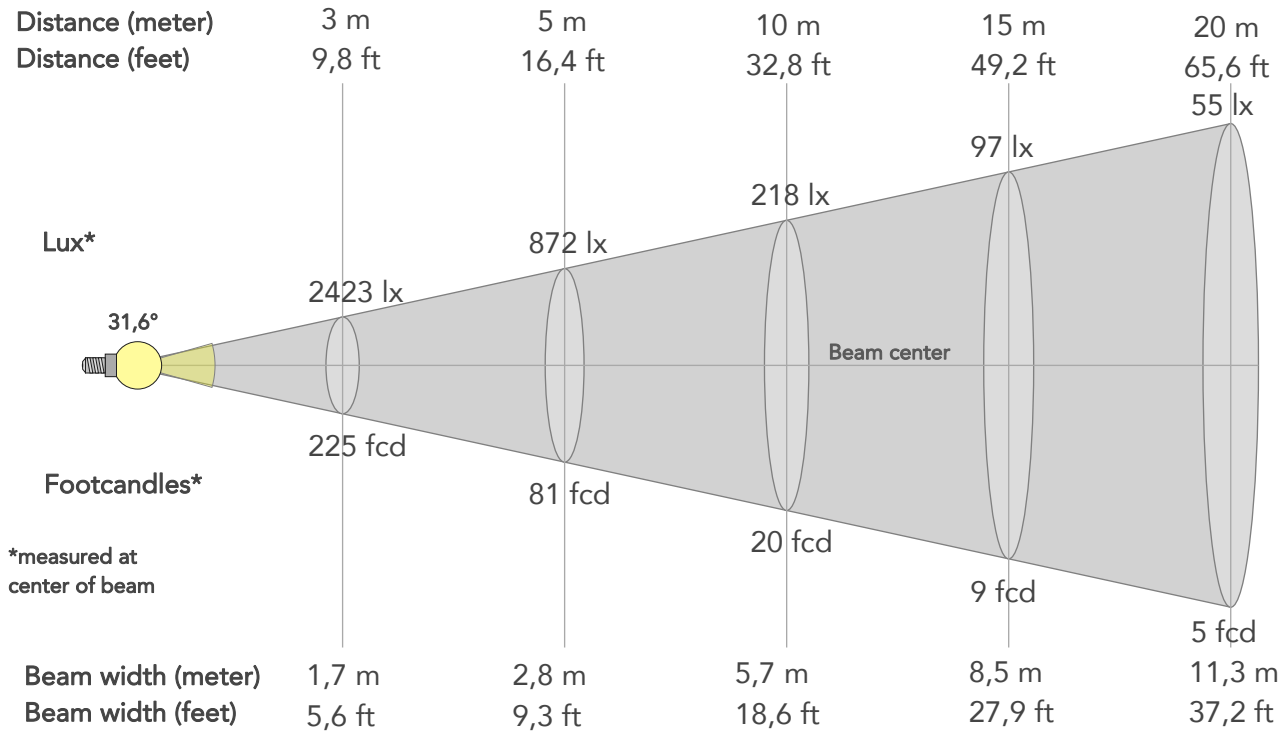

## BEAM INTENSITIES AND WIDTHS

Distance	1m	2m	3m	4m	5m	7,5m	10m	15m	20m	25m	30m	40m	50m
Distance	3,3ft	6,6ft	9,8ft	13,1ft	16,4ft	24,6ft	32,8ft	49,2ft	65,6ft	82ft	98,4ft	131,2ft	164ft
Lux	21805lx	5451lx	2423lx	1363lx	872lx	388lx	218lx	97lx	55lx	35lx	24lx	14lx	9lx
Footcand.	2026fcd	506fcd	225fcd	127fcd	81fcd	36fcd	20fcd	9fcd	5fcd	3fcd	2fcd	1fcd	1fcd
Beam wid.	0,6m	1,1m	1,7m	2,3m	2,8m	4,3m	5,7m	8,5m	11,3m	14,2m	17m	22,7m	28,3m
Beam wid.	1,9ft	3,7ft	5,6ft	7,4ft	9,3ft	13,9ft	18,6ft	27,9ft	37,2ft	46,5ft	55,8ft	74,4ft	93ft

## LINEAR DISTRIBUTION DIAGRAM

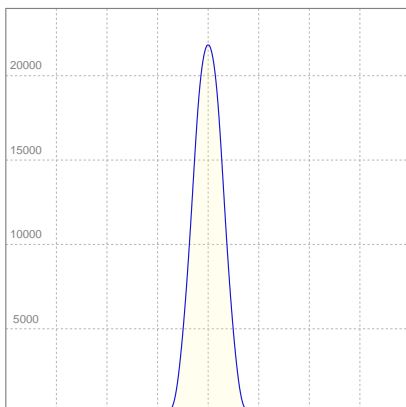

## ELECTRICAL SPECIFICATIONS

Input voltage	Input current	Input power	Effeciency
229V	0,899A	186,9W	36lm/W



## ISO CANDELA DIAGRAM

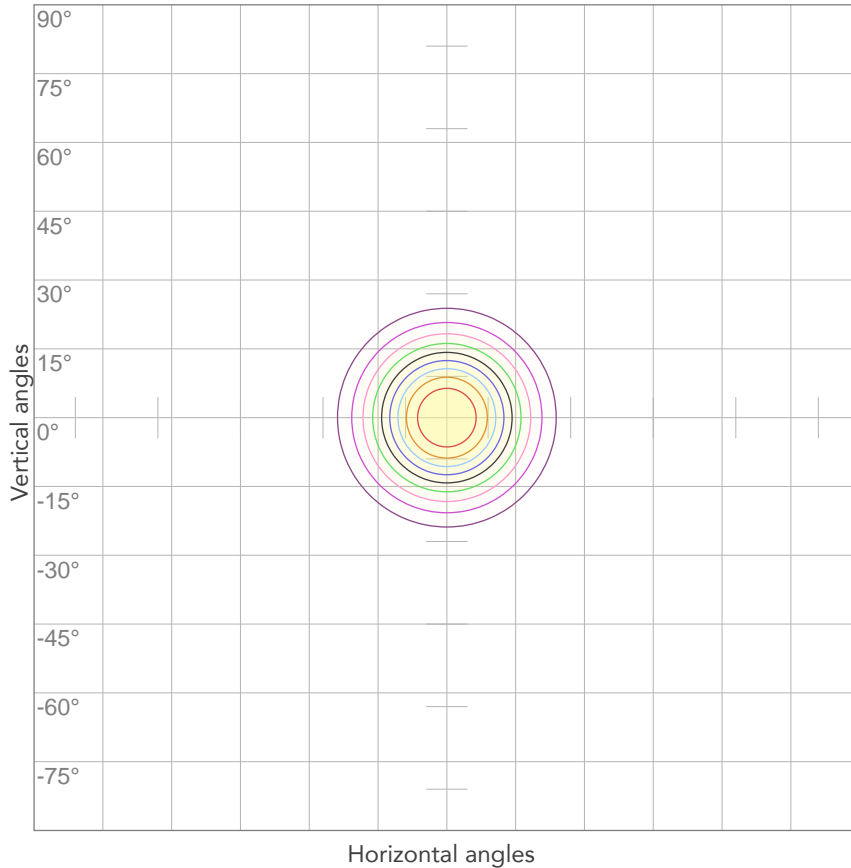

10%	2180 cd
20%	4361 cd
30%	6541 cd
40%	8722 cd
50%	10902 cd
60%	13083 cd
70%	15263 cd
80%	17444 cd

Conditions:

Number of c-planes: 2

Candela at center: 21805 cd

## ISO LUX DIAGRAM

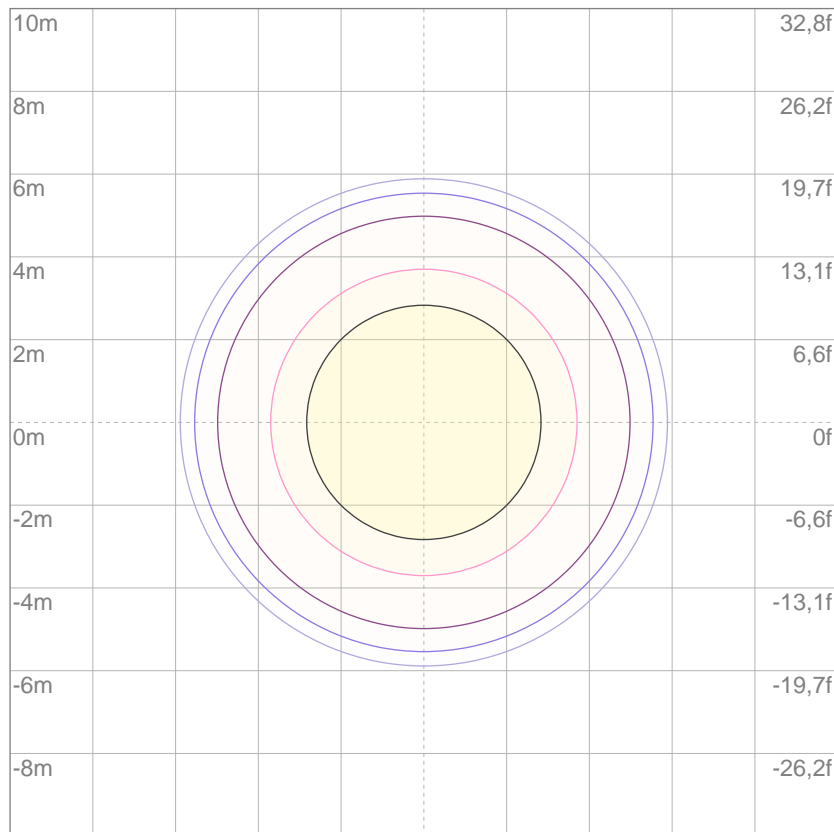

3%	6,54 lx
5%	10,9 lx
10%	21,8 lx
30%	65,4 lx
50%	109 lx

Conditions:

Number of c-planes: 2

Lux at center: 218 lx

*Lux distribution on a surface when lamp is mounted at 10 meters from the surface.*

Mounting height: 10 meters (33 feet)



Total lumen output:

4292 lm

Total candela output:

38253 cd

Light quality:

CRI: 88,8

Color temperature:

5743 K

## PRODUCT NAME:

EclipseFresnel TW

## MEASUREMENT CONDITIONS:

Beam angle:

15°

Target:

6000K

Operator:

Marco Marrocco

Date and time:

14/12/2019 11:22:12

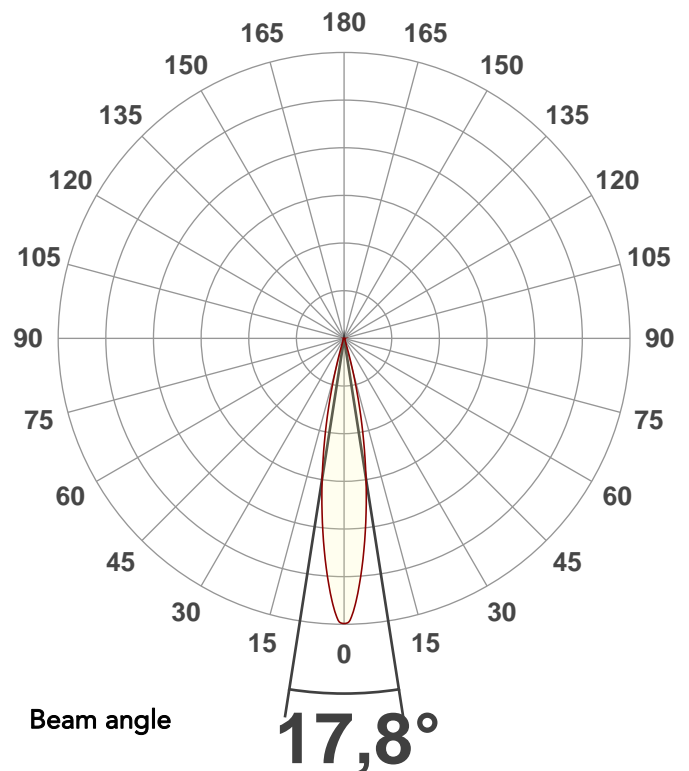

Spectra

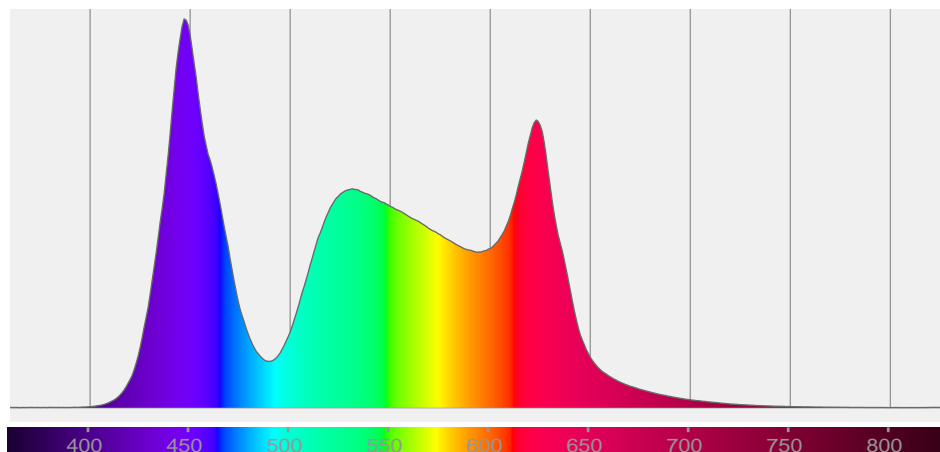

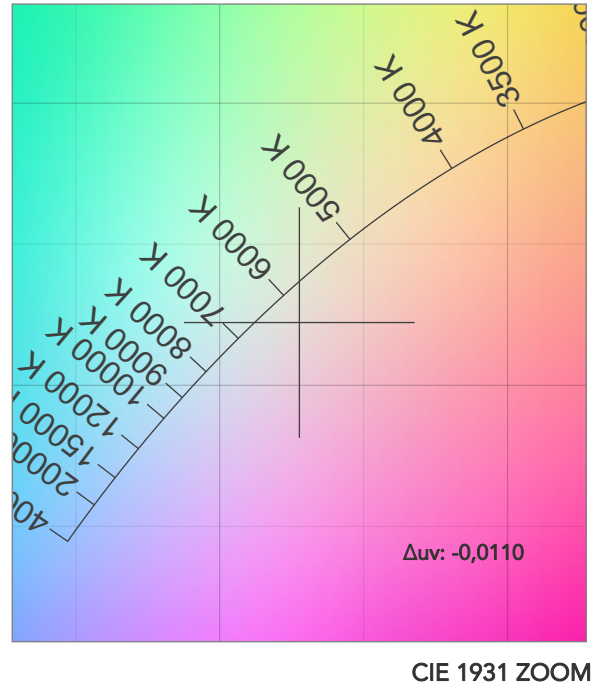
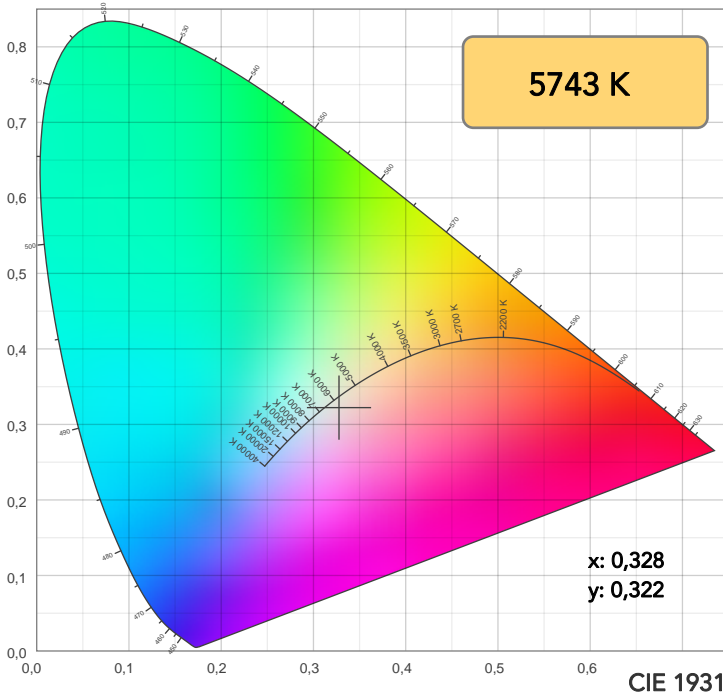

TM30: 81,1

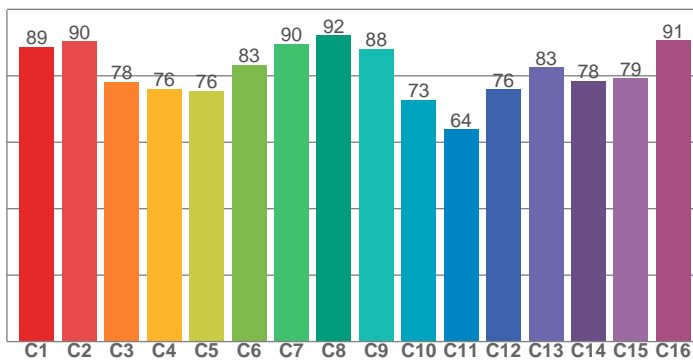

CRI: 88,8 (R1-R8)

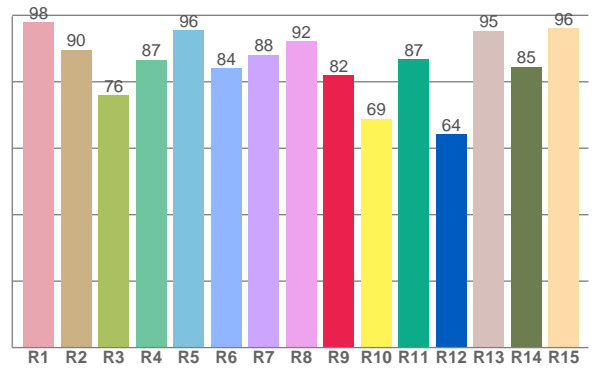

CRI R values, only R1-R8 are used to calculate final CRI value

R1	R2	R3	R4	R5	R6	R7	R8	R9	R10	R11	R12	R13	R14	R15
97,9	89,6	76,0	86,7	95,5	84,1	88,2	92,3	82,0	68,9	86,7	64,2	95,3	84,5	96,2

TM30 C values, 16 binned values out of total of 99 C values

C1	C2	C3	C4	C5	C6	C7	C8	C9	C10	C11	C12	C13	C14	C15	C16
88,6	90,4	78,2	76,0	75,5	83,3	89,7	92,2	88,0	72,8	63,9	76,0	82,6	78,5	79,2	90,7

CQS Q values

Q1	Q2	Q3	Q4	Q5	Q6	Q7	Q8	Q9	Q10	Q11	Q12	Q13	Q14	Q15
92,8	93,2	68,1	70,8	84,4	88,4	88,1	98,0	83,2	77,4	78,9	85,1	91,8	92,0	92,7

CQS: 83,4

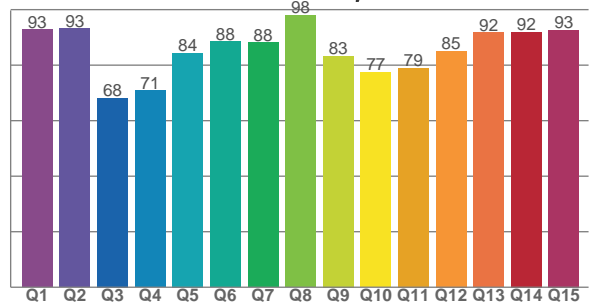

COLOR PARAMETERS

Color temperature	Color rendering index	Red component	Color fidelity	Color gamut	Color quality scale	Television lighting index	Color coordinate cie 1931	Color coordinate cie 1931	Color deviation from black body
CCT	CRI	CRI R9	TM30 Rf	TM30 Rg	CQS	TLCI	x	y	Δuv
5743 K	88,8	82,0	81,1	105,5	83,4	77	0,328	0,322	-0,0110

# TM30 DETAILS

**Rf 81,1**  
Fidelity index Rf

**Rg 105,5**  
Gammut index

Hue Bin	R <sub>f</sub>	Graphic shifts (%)	
		Chroma	Hue
1	89	-4%	-1%
2	90	-2%	3%
3	78	-1%	11%
4	76	3%	13%
5	76	8%	10%
6	83	11%	4%
7	90	5%	-3%
8	92	-1%	-3%
9	88	-7%	4%
10	73	-7%	13%
11	64	0%	20%
12	76	5%	14%
13	83	11%	7%
14	78	10%	5%
15	79	14%	-9%
16	91	3%	-4%

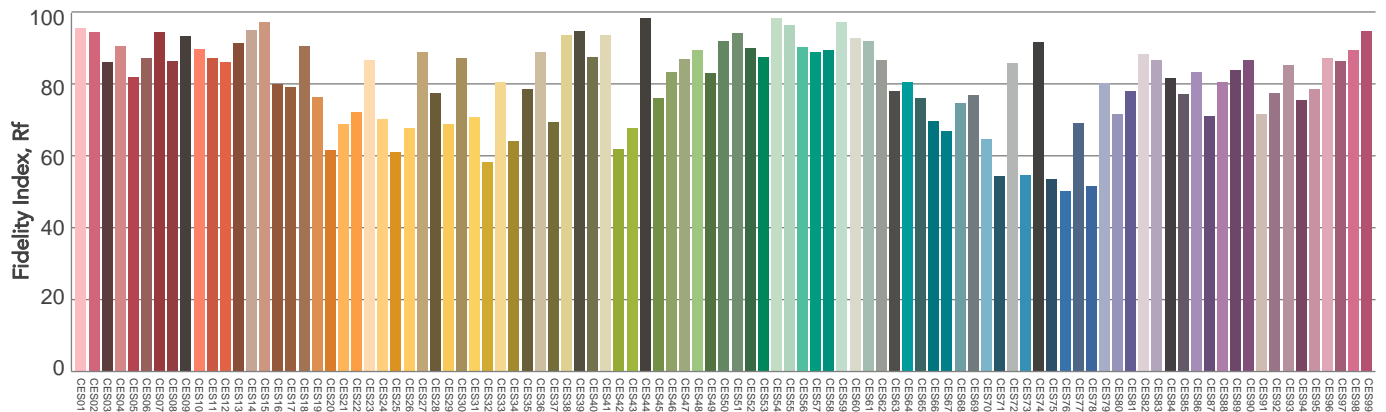
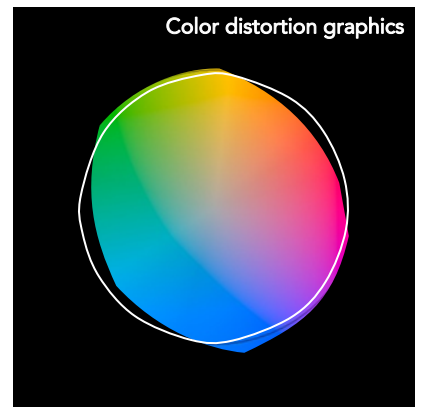
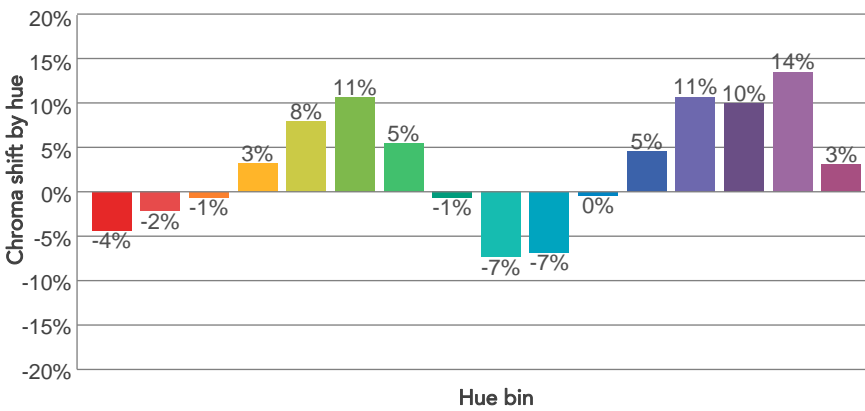
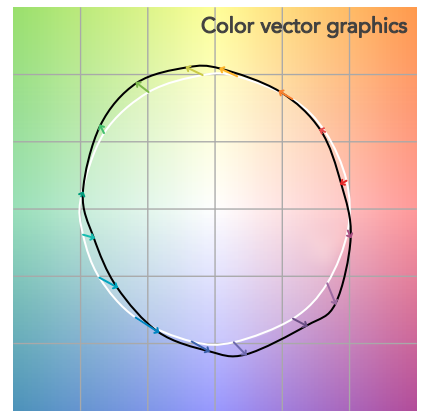
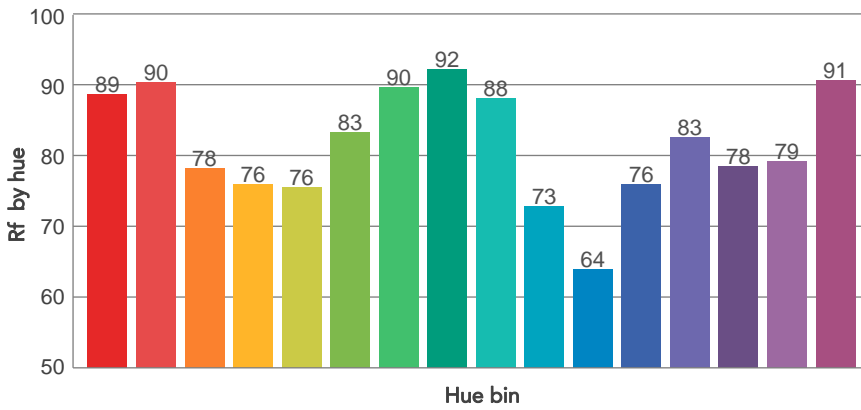
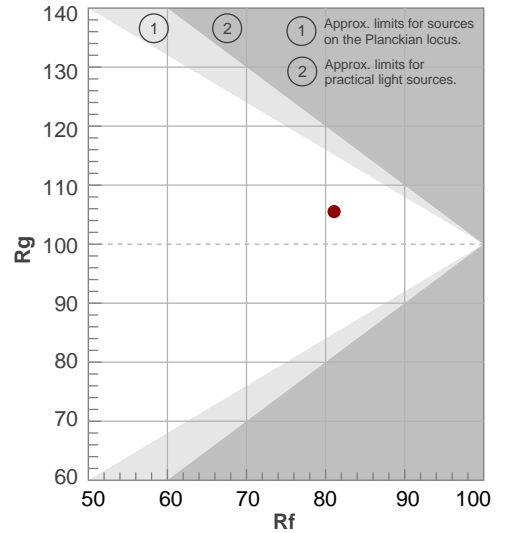

Color Evaluation Sample

# BEAM DETAILS



Beam angle 50%	Field angle 10%	Cutoff angle 2,5%	Intensity ratio in 120° cone	Intensity ratio in 90° cone
17,8°	30,9°	38,1°	99,2%	97,7%

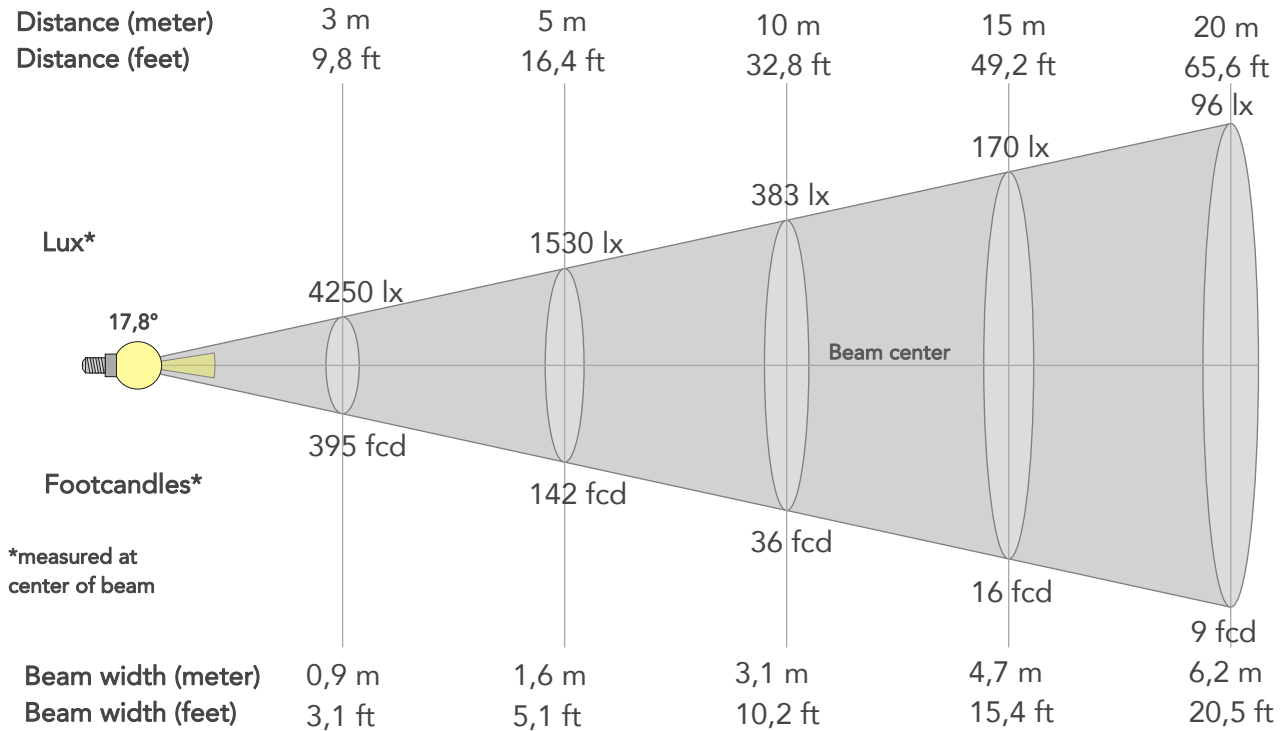

## BEAM INTENSITIES AND WIDTHS

Distance	1m	2m	3m	4m	5m	7,5m	10m	15m	20m	25m	30m	40m	50m
Distance	3,3ft	6,6ft	9,8ft	13,1ft	16,4ft	24,6ft	32,8ft	49,2ft	65,6ft	82ft	98,4ft	131,2ft	164ft
Lux	38253lx	9563lx	4250lx	2391lx	1530lx	680lx	383lx	170lx	96lx	61lx	43lx	24lx	15lx
Footcand.	3554fcd	888fcd	395fcd	222fcd	142fcd	63fcd	36fcd	16fcd	9fcd	6fcd	4fcd	2fcd	1fcd
Beam wid.	0,3m	0,6m	0,9m	1,2m	1,6m	2,3m	3,1m	4,7m	6,2m	7,8m	9,4m	12,5m	15,6m
Beam wid.	1ft	2,1ft	3,1ft	4,1ft	5,1ft	7,7ft	10,2ft	15,4ft	20,5ft	25,6ft	30,7ft	41ft	51,2ft

## LINEAR DISTRIBUTION DIAGRAM

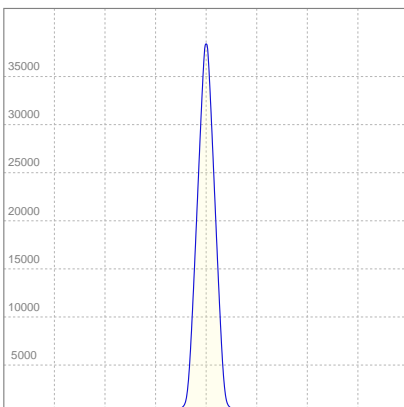

## ELECTRICAL SPECIFICATIONS

Input voltage	Input current	Input power	Effeciency
227V	0,892A	184,4W	23lm/W

## ISO CANDELA DIAGRAM

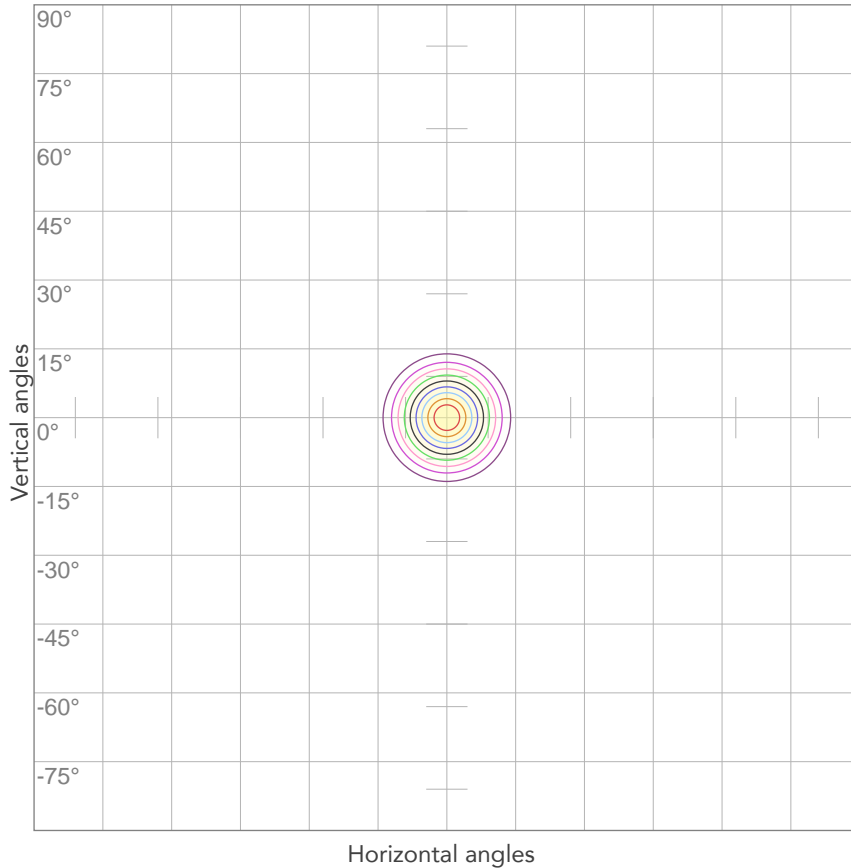

10%	3825 cd
20%	7651 cd
30%	11476 cd
40%	15301 cd
50%	19127 cd
60%	22952 cd
70%	26777 cd
80%	30603 cd

Conditions:

Number of c-planes: 2

Candela at center: 38253 cd

## ISO LUX DIAGRAM

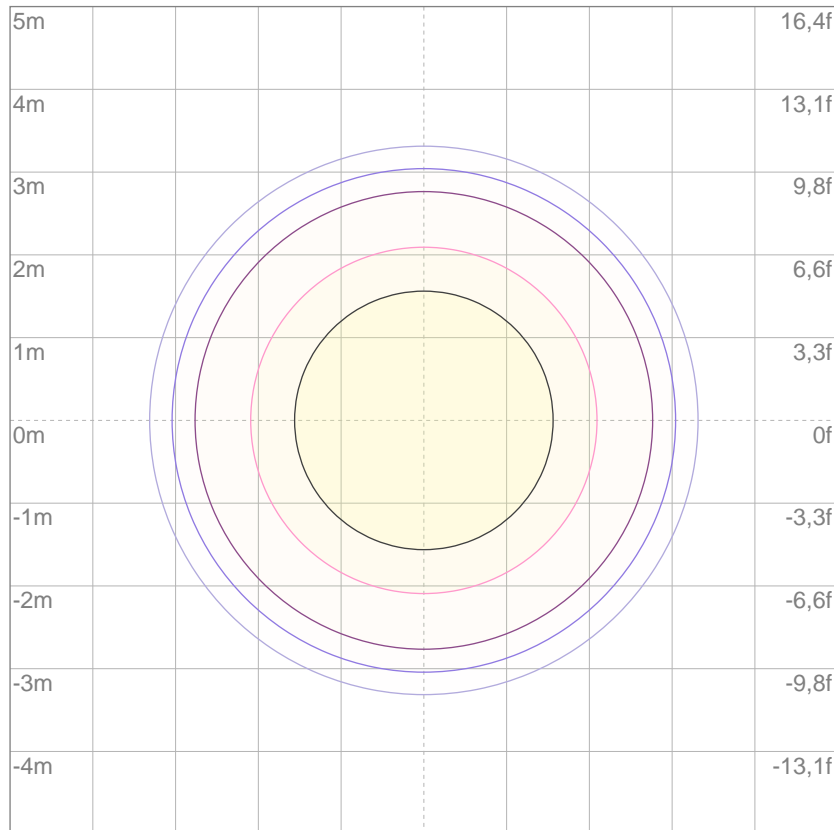

3%	11,5 lx
5%	19,1 lx
10%	38,3 lx
30%	115 lx
50%	191 lx

Conditions:

Number of c-planes: 2

Lux at center: 383 lx

*Lux distribution on a surface when lamp is mounted at 10 meters from the surface.*

Mounting height: 10 meters (33 feet)