

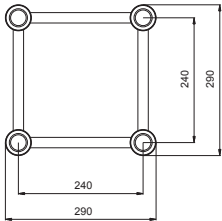

HQ30

Heavy square section aluminium truss with 29cm sides

- Lengthwise: extruded tubes, Ø 50x3 mm 6082 T6
- Diagonal: extruded tubes, Ø 20x2 mm 6082 T6
- Plate: conical quick-lock connectors
- Fast connection kit FCQ5 included

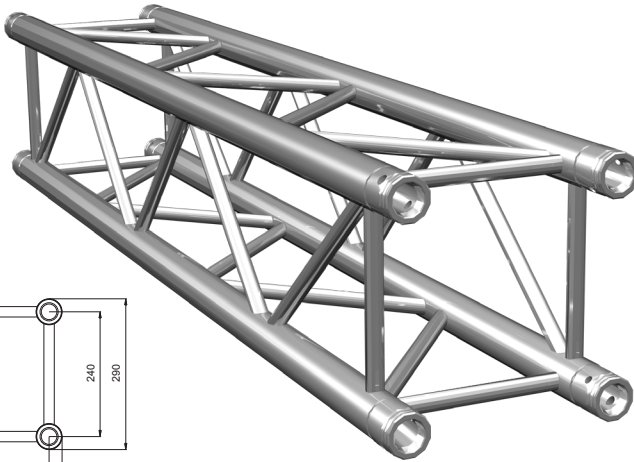

Variants

Code	Black Vers.	Tube (mm)	Diagonal (mm)	W (cm)	H (cm)	D (cm)	Weight (kg)	Volume (mc)
HQ30050	HQ30050B	50x3	20x2	50	29	29	4.10	0.042
HQ30100	HQ30100B	50x3	20x2	100	29	29	7.10	0.084
HQ30150	HQ30150B	50x3	20x2	150	29	29	10.60	0.126
HQ30200	HQ30200B	50x3	20x2	200	29	29	13.70	0.168
HQ30250	HQ30250B	50x3	20x2	250	29	29	16.70	0.210
HQ30300	HQ30300B	50x3	20x2	300	29	29	19	0.252
HQ30350	HQ30350B	50x3	20x2	350	29	29	23	0.294
HQ30400	HQ30400B	50x3	20x2	400	29	29	24.90	0.336
HQ30450	HQ30450B	50x3	20x2	450	29	29	27.80	0.378
HQ30500	HQ30500B	50x3	20x2	500	29	29	31	0.421

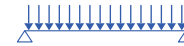
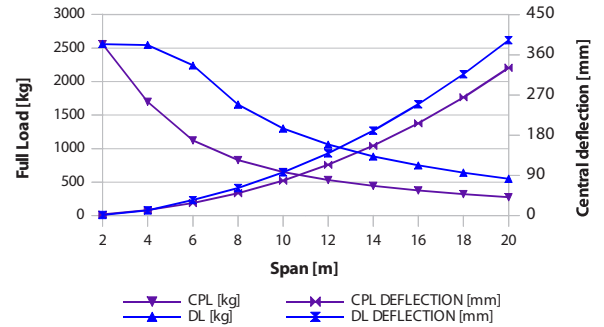

Distributed Load



Centre Point Load

SPAN [m]	Distributed Load			Centre Point Load	
	Point load [kg/m]	Full load [kg]	Central deflection [mm]	Full load [kg]	Central deflection [mm]
2	1280.2	2560.4	1.4	2560.3	2.3
4	636.7	2546.8	11.6	1697.2	12.3
6	373.4	2240.4	34.6	1120.2	27.9
8	207.1	1656.8	61.7	828.2	49.8
10	130.1	1301	96.6	650.4	78.3
12	88.3	1059.6	139.4	529.5	113.7
14	63	882	190.3	441.3	156.3
16	46.7	747.2	249.3	373.4	206.4
18	35.5	639	316.7	319.1	264.5
20	27.4	548	392.6	274.3	331



Included

FCQ5

Quick connection, 4 spigots, 8 pins, 8 safety spring, SQ-HQ30/40



Joins

Variants

Code	Black Vers.	Type	Way (nr)	Angle	Orient.	Vertex	W (cm)	H (cm)	D (cm)
HQ30L2045	HQ30L2045B	L2	2	45°	-	-	50	29	50
HQ30L2060	HQ30L2060B	L2	2	60°	-	-	50	29	50
HQ30L2090	HQ30L2090B	L2	2	90°	-	-	50	29	50
HQ30L2120	HQ30L2120B	L2	2	120°	-	-	50	29	50
HQ30L2135	HQ30L2135B	L2	2	135°	-	-	50	29	50
HQ30L3	HQ30L3B	L3	3	90°	-	-	50	29	50
HQ30T3	HQ30T3B	T3	3	90°	-	-	50	50	50
HQ30X4	HQ30X4B	X4	4	90°	-	-	50	50	50
HQ30T4	HQ30T4B	T4	4	90°	-	-	50	50	50
HQ30T5	HQ30T5B	T5	5	90°	-	-	50	50	50
HQ30X6	HQ30X6B	X6	6	90°	-	-	50	50	50
HQ30K8	HQ30K8B	K8	6	90°	-	-	29	29	29

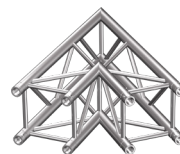

HQ30L2045

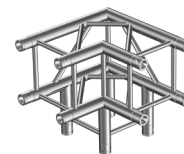

HQ30L3

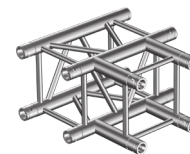

HQ30T3

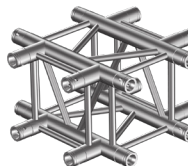

HQ30X4

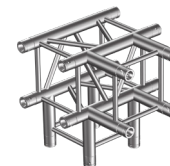

HQ30T4

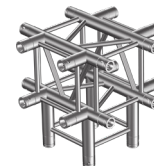

HQ30T5

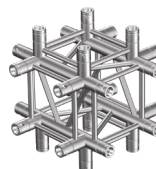

HQ30X6

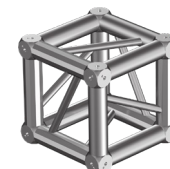

HQ30K8

Circular Trusses

Variants

Code	Black Vers.	Orient.	Vertex	D.Ext (cm)	D.Int. (cm)	H (cm)	D (cm)	Weight (kg)	Arc num
HQ30C200	HQ30C200B	-	-	200	142	29	29	9	4
HQ30C300	HQ30C300B	-	-	300	242	29	29	14	4
HQ30C400	HQ30C400B	-	-	400	342	29	29	19.10	4
HQ30C500	HQ30C500B	-	-	500	442	29	29	24.30	8
HQ30C600	HQ30C600B	-	-	600	542	29	29	29.50	8
HQ30C700	HQ30C700B	-	-	700	642	29	29	34.60	8
HQ30C800	HQ30C800B	-	-	800	742	29	29	39.80	8
HQ30C900	HQ30C900B	-	-	900	842	29	29	44.90	12
HQ30C1000	HQ30C1000B	-	-	1000	942	29	29	50.10	12

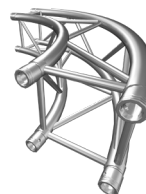

heavy square section circular aluminium truss structure with 30cm sides

- Lengthwise: extruded tubes, Ø 50x3 mm 6082 T6
- Diagonal: extruded tubes, Ø 25x3 mm 6082 T6
- Plate: conical quick-lock connectors
- x4 Fast connection kits FCQ5 included



Optional accessories

FCQ5K8

Quick connection, 4 h/spigot, 4 pins, 4 safety spring, HQ-SQ30/40K8



SQ30FP

Aluminium ground base for square section trusses, SQ-HQ30,