

MZX1002

MIXER ZONE

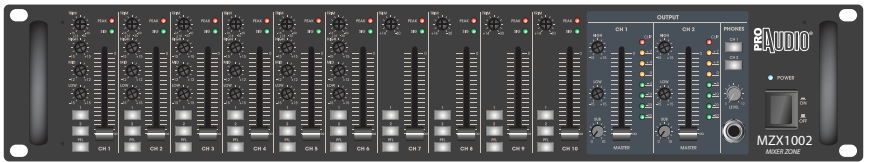

USER MANUAL

All rights reserved by Music & Lights S.r.l. No part of this instruction manual may be reproduced in any form or by any means for any commercial use.

In order to improve the quality of products, Music&Lights S.r.l. reserves the right to modify the characteristics stated in this instruction manual at any time and without prior notice.
All revisions and updates are available in the 'manuals' section on site www.musiclights.it

CONTENTS

Safety

General instructions	4
Warnings and installation precautions	4

1 Introduction

1.1 Features	5
--------------------	---

2 Operating elements and connections

2.1 Front Panels	6
2.2 Rear Panels	7
2.3 Connections	8
2.4 Block diagrams	11
2.5 Specifications	12

3 General criteria for installation of sound systems

Packing content:

- MZX1002
 - User manual
-



WARNING!



Before carrying out any operations with the unit, carefully read this instruction manual, and keep it with care for future reference.

It contains important information about the installation, usage and maintenance of the unit.

SAFETY

General instruction

- The products referred to in this manual conform to the European Community Directives and are therefore marked with **CE**.
- The unit is supplied with hazardous network voltage (230V~). Leave servicing to skilled personnel only. Never make any modifications on the unit not described in this instruction manual, otherwise you will risk an electric shock.
- Connection must be made to a power supply system fitted with efficient earthing (Class I appliance according to standard EN 60598-1). It is, moreover, recommended to protect the supply lines of the units from indirect contact and/or shorting to earth by using appropriately sized residual current devices.
- The connection to the main network of electric distribution must be carried out by a qualified electrical installer. Check that the main frequency and voltage correspond to those for which the unit is designed as given on the electrical data label.
- This unit is not for home use, only professional applications.
- Make certain that no inflammable liquids, water or metal objects enter the fixture.
- Do not dismantle or modify the fixture.
- All work must always be carried out by qualified personnel. Contact the nearest sales point for an inspection or contact the manufacturer directly.
- If the unit is to be put out of operation definitively, take it to a local recycling plant for a disposal which is not harmful to the environment.

Warnings and installation precautions

- This product in combination with amplifier, may be capable of producing dangerous sound levels that could cause permanent hearing loss. Do not operate for a long period of time at high volume level or at a level that is uncomfortable.
- If this device will be operated in any way different to the one described in this manual, it may suffer damages and the guarantee becomes void. Furthermore, any other operation may lead to dangers like short circuit, burns, electric shock, ect.
- Do not install the fixture near sources of heat.
- The fixture must be located in a place where a proper ventilation or thermal dissipation is not impeded. Do not install the fixture in a confined space.
- The output level of the amplifier must never exceed the marked sensitivity.
- Do not link the output of any amplifier channel back into another channel's input. Do not parallel or series connect an amplifier's output with any other amplifier's output.
- Make sure that the signal is correctly connected to the amplifier's input channel and set to proper input mode.
- Please turn off the power switch before pulling off the power cord.
- Before starting any maintenance work or cleaning the unit, cut off power from the main supply.
- When cleaning unit, please do not use solvents such as acetone or alcohol, since they may damage the of the unit outer finish and the printings on the panels.



- 1 - INTRODUCTION

1.1 - Features

- Versatile function and compact size
- 6 Channels MIC input with XLR jack
- 10 Channels LINE input with 1/4" phone jack
- 4 Channels LINE input with RCA jack
- 3 Band EQ control on every MIC channels
- Acceptable wide range input level with trim pot
- Useful monitoring function on the whole input and output channels with PFL/AFL switches.
- 2 Band EQ control on every output channels
- Signal and peak indicator on each input channels.
- DC+18V phantom power for condenser microphone on the MIC channel 1 and 2
- Useful ducking function on the MIC channel 1 and 2
- 1 Priority input channel for emergency announcement
- 2 Insert channels allow connecting external effector
- Multi channel output as 2 main output, 2 sub output and 2 record output
- Useful slide fader for each input level and main output level
- Runs on 1220-240VAC and 24VDC for evacuation orders.

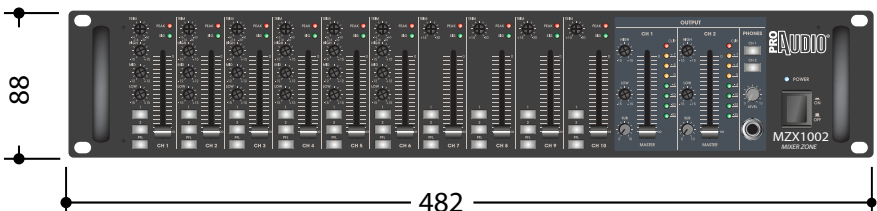

Technical drawing

Fig.1

- 2 - OPERATING ELEMENTS AND CONNECTIONS

2.1 - Front Panels

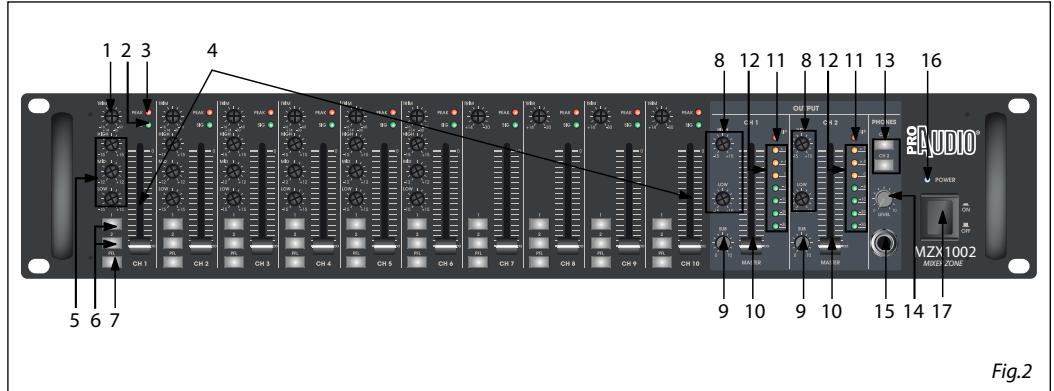
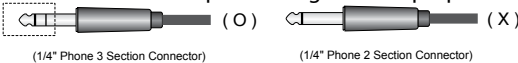

Fig.2

1. **TRIM CONTROLS** These controls allow accept variable input level. They have 44dB adjustable range as -60dB to -16dB for microphone level and -30dB to +14dB for line level.
2. **SIGNAL INDICATORS** These indicators show present input signal on the each input channels.
3. **PEAK INDICATORS** These indicators warn against clipping shortly on the each input channel. M&L recommend for users to adjust TRIM control when PEAK indicator is flickering to make best performance.
4. **INPUT CHANNEL FADER** These faders allow level adjust for each input channel.
5. **INPUT CHANNEL EQ CONTROLS** 6 MIC input channels have 3 bands equalizer which is adjustable over a wide range.
6. **OUTPUT CHANNEL SELECTORS** These selectors allow each input signal through out to selected output channel. This function is in MZX1002 only.
7. **PFL SWITCHES** This switch allows you to monitor the pre-fader signal of input channel through headphone output.
8. **OUTPUT CHANNEL EQ CONTROLS** Output channels have 2 bands equalizer which is adjustable over a wide range.
9. **SUB OUTPUT LEVEL CONTROLS** These controls allow level adjust for sub output channels.
10. **OUTPUT CHANNEL FADER** These faders allow level adjust for main output channels.
11. **CLIP INDICATORS** These indicators warn against clipping shortly on the each output channel. M&L recommend for users to adjust output fader when CLIP indicator is flickering to make best performance.
12. **OUTPUT LEVEL METERS** These indicators show output signal level.
13. **AFL SWITCHES** This switch allows you to monitor the main output signal of output channel through headphone output.
14. **HEADPHONE LEVEL CONTROL** This control allows you adjust the signal level of headphone output
15. **HEADPHONE JACK TERMINAL** M&L recommend for users to use a standard 6.3mm (1/4") jack for connection of headphones. Fig.3 shows proper headphone plug for standard 6.3mm (1/4") jack.



(1/4" Phone 3 Section Connector)

(1/4" Phone 2 Section Connector)

16. **POWER INDICATOR** This indicator shows power on/off status.
17. **POWER SWITCH** Device will be supplied power when this switch is pressed and locked.

2.2 - Rear Panels

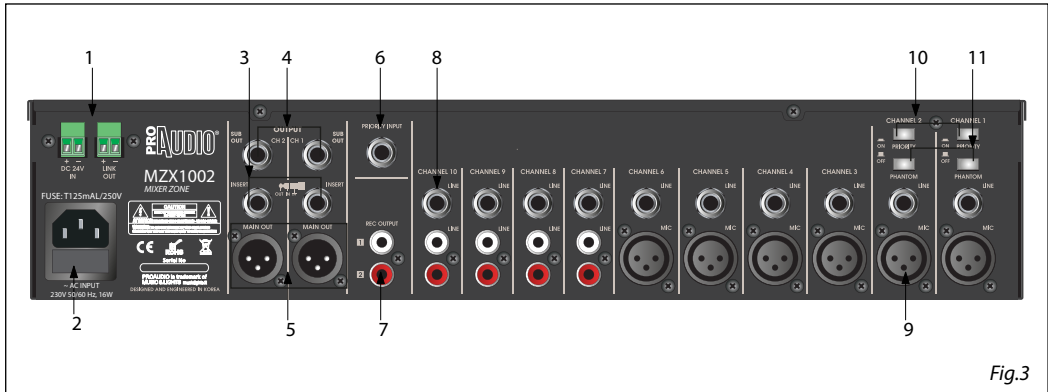
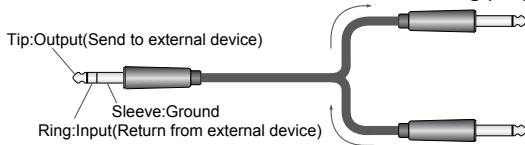

Fig.3

- 1. DC 24V INPUT AND LINK OUTPUT** Device will be supplied DC 24V through input terminal and supply to other device through link output terminal.
- 2. AC INLET** This AC inlet allows replacing fuse conveniently. Please make sure the value of fuse before replacement.
- 3. CHANNEL INSERT** These insert jacks allow connecting external effectors like compressor, limiter, noise filters. M&L would like to recommend using proper insert cable as below Fig.6



- 4. SUB OUTPUT** Sub output channel is prepared for sub amplifier.
- 5. MAIN OUTPUT** Main amplifier will be connected to this output terminal.
- 6. PRIORITY INPUT** Whole other input signals will be muted automatically by priority input signal. This terminal will be used to evacuation announcement.
- 7. RECORD OUTPUT** This terminal allows recording with tape recorder.
- 8. LINE INPUTS** These line inputs can be connected line level equipments. This device allows connecting 6 balanced(CH1-6) and 4 unbalanced(CH7-10) inputs. Also allow adjusting level with TRIM pot of front panel to accept variable input sources.
- 9. MICROPHONE INPUTS** This device allows connecting 6 balanced microphone input with acceptable wide impedance range from 50ohm to 600ohm.
- 10. PRIORITY SWITCHES** These switches allow talk over for MIC channel 1 and 2. All other input signals except priority input channel are muted when this function is activated during press. MIC channel 1 and 2 have same priority grade as priority input channel during these swithes are pressed.
- 11. PHANTOM POWER SWITCHES** This device supply DC+18V phantom power to use condenser microphone with MIC1 and 2 channels.

2.3 - Connections

M&L products are wired to reflect accepted wiring practices used throughout the world.

Balanced XLR connectors are wired as described:

Pin #1 Shield

Pin #2 Positive

Pin #3 Negative

Balanced 1/4" TRS connectors are wired as described:

Tip is Positive

Ring is Negative

Sleeve is Shield

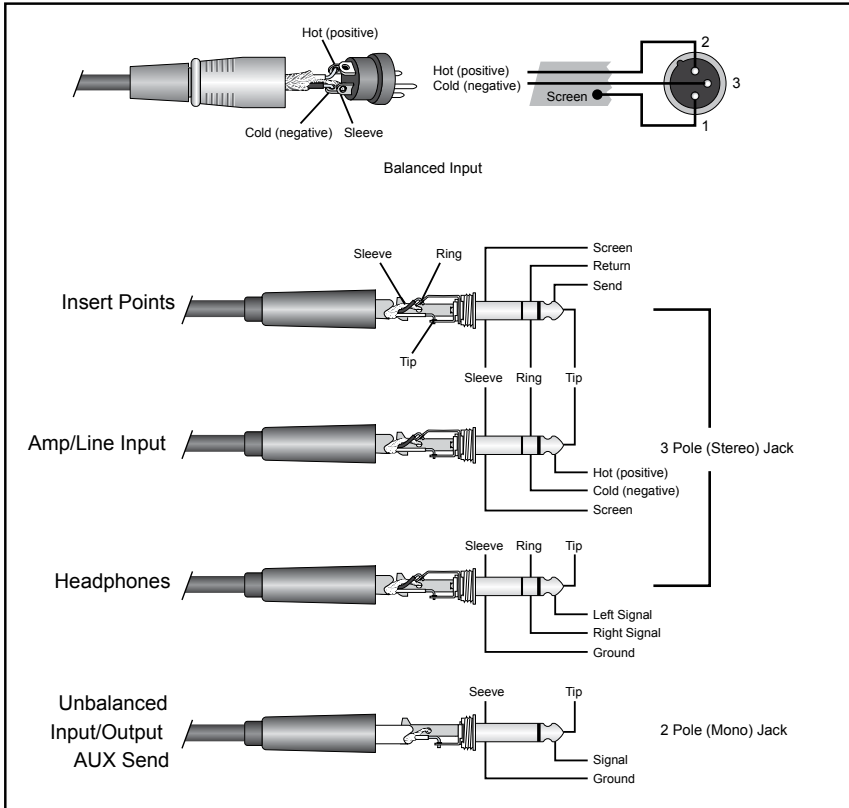

Fig.4

2.3 - Connections

CONNECTOR AND CABLE CONFIGURATIONS

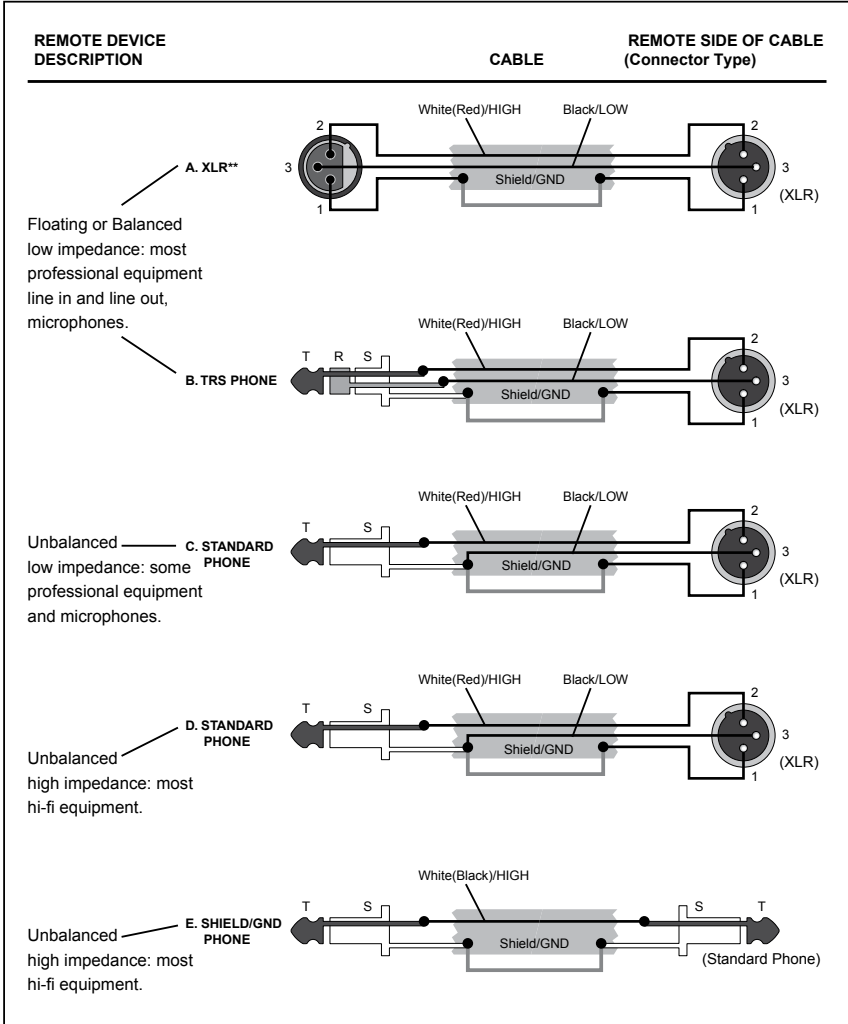

Fig.5

2.3 - Connections

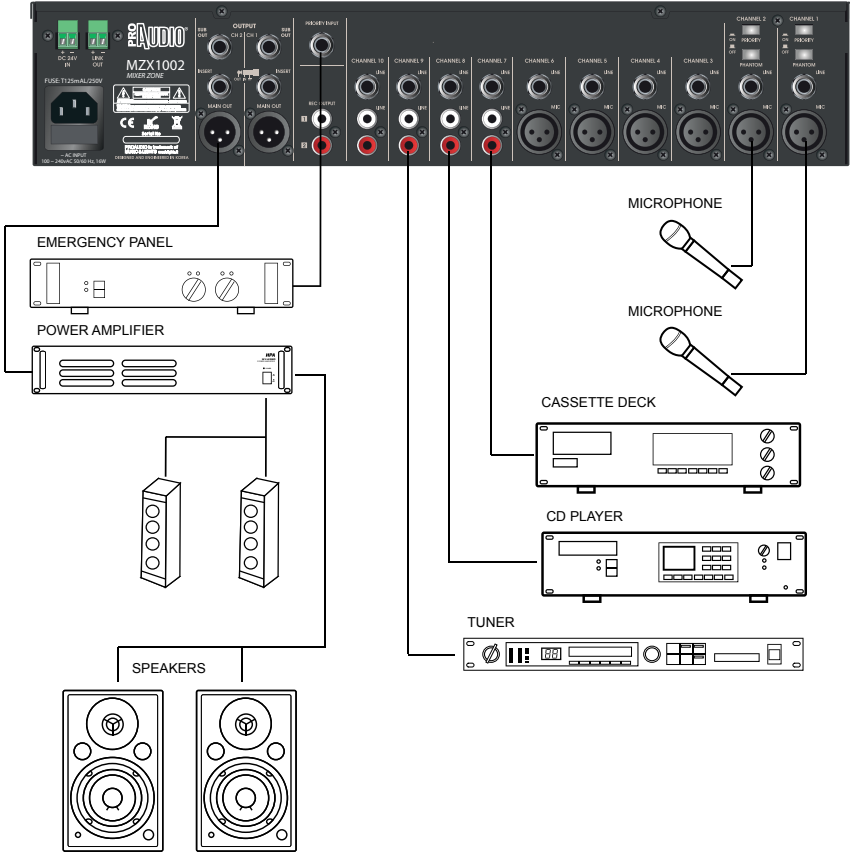

Fig.6

2.4 - Block diagrams

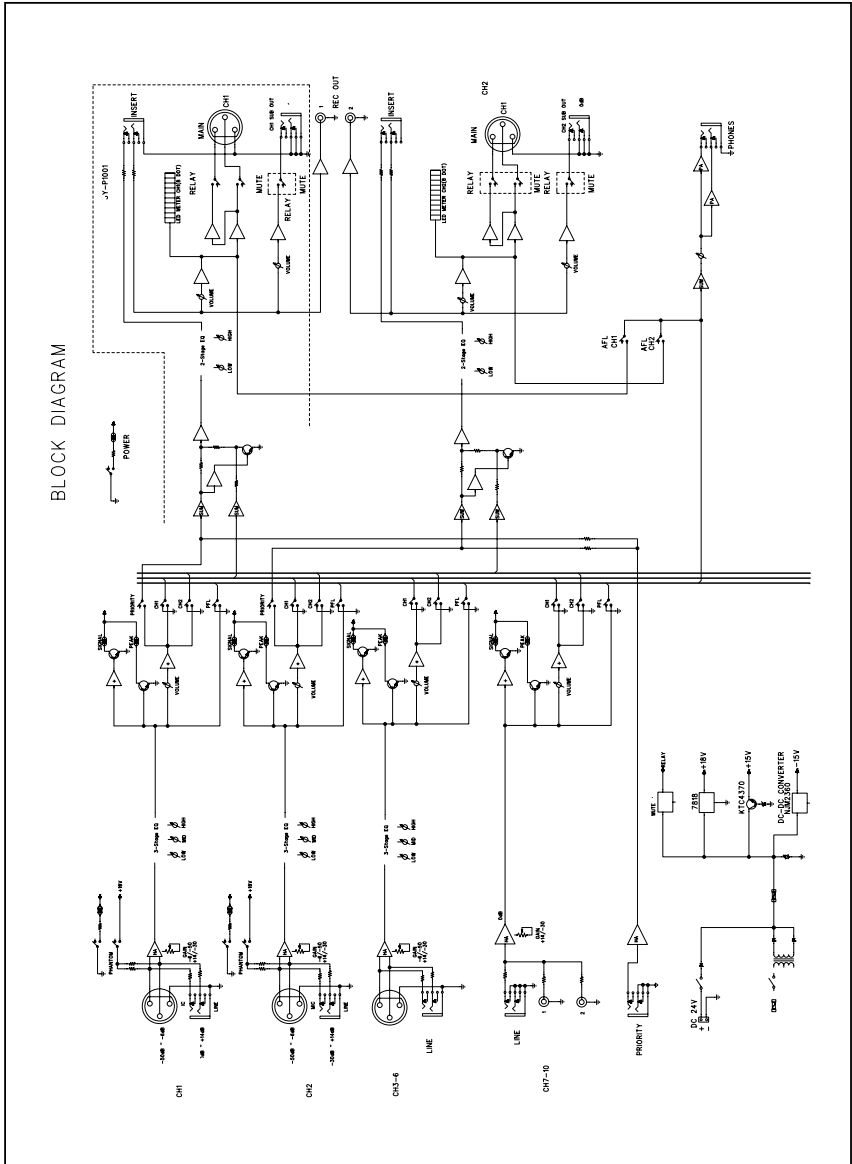

Fig.7

2.5 - Specifications

Technical data	MZX1002
Rated Output Level / Impedance	0dB / 600 Ω Balanced
Input sensitivity/ impedance mic input	- 60dB~ - 6dB / 20K Ω Balanced
Input sensitivity/ impedance line input	-30dB~ + 14dB / 20K Ω Balanced
Input connections	XLR, Mic 1-6, 6.3mm jack for line 1 - 10, RCA for Line 7-10
Output connections	XLR, 6.3mm jack
Frequency response	20/20.000Hz (\pm 3dB)
Distortion (THD)	<0.1% (1KHz)
Tone controls input	80 Hz, 2.5kHz, 12kHz (\pm 12dB)
Tone controls output	100 Hz, 10kHz (\pm 15dB)
Power supply	AC 230 Volt, 50~60Hz - DC 24V
Rack units	2U
Phantom power	+18VDC Mic 1 - 2
Dimensions (WxHxD)	420x88x325 mm
Weight	5,3 kg

- 3 - GENERAL CRITERIA FOR INSTALLATION OF SOUND SYSTEMS

Introduction

This guide represents a quick introduction to the criteria for the installation of a sound system at constant voltage or constant impedance.

A sound system must be made by qualified personnel only, who must evaluate the needs of the user and the environmental characteristics of the spaces to be covered, select the speakers according to the spaces and the type of message to be broadcasted (ie: speech / music), identify the suitable amplifier model to drive the complex of all the speakers and having an adequate number of inputs, evaluate the proper connection for the speakers and determine the section of the wiring.

Constant voltage systems

In terms of selection of speakers and their connection it's necessary to evaluate whether to use normal speakers with 4/8/16Ohm impedance or speakers with transformer. The decision is usually influenced by the destination of the system (supermarket, disco , pub, house, ...) and by the number of speakers to employ. Constant voltage speakers are normally used into situations where it is necessary to install several speakers with low power to get a homogeneous distribution of audio and overall low volume. The classic example is the sound installation in airports or supermarkets. In these situations several speakers are usually placed within a short distance between them, normally a volume low enough to not disturb and a frequency covering the entire area with same sound pressure.

Differences between 4/8/16 Ohms systems and constant voltage systems

The 4/8/16Ohm systems are affected by problems of impedances:

- speakers connected in "series" mode add their impedance (example: 40hm + 40hm = 80hm)
- speakers connected in "parallel" mode divide their impedance (example: 80hm // = 80hm 40hm)

In the following pictures find a few examples of connections: series, parallel, series + parallel. Also the applicable power is reported according to type and impedance of each speaker. Please note polarity indicated for each speaker. Constant voltage systems use speakers equipped with transformer. Normally they can be configured on 2 or more different maximum power levels. In this type of system only 2 conductors are employed: the black one is connected to the negative terminal (usually marked by "0" or "COM"), the red one is connected to one of the contacts (50V, 70V, 100V). The amplifier driving all speakers will be connected to such 2 wires paying attention that right polarities are respected.

Please note that:

- Voltage selected on speaker transformer must match the voltage selected on the amplifier.
- Total sum of speakers power must not exceed power of the amplifier.
- To ensure a correct reproduction of the audio signal it is important to setup the connection with no phase shifts: the connection between positive and negative poles of the amplifier must match the polarity on speaker transformer.
- It is important that cables have an adequate section: increasing total length of the sound installation involves increasing of cable section to avoid distortion or signal loss.
- Cables for connection of the speakers should be passed separately from other electrical or microphone cables, to avoid ground loops or triggers of any kind.
- It's always important to use cables with twisted wires

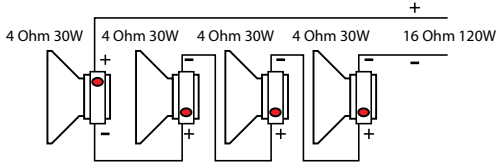

SERIES CONNECTION

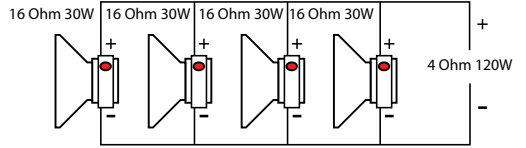

PARALLEL CONNECTION

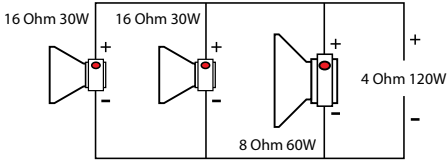

PARALLEL CONNECTION

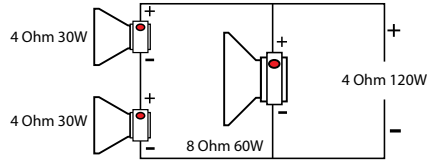

SERIES + PARALLEL CONNECTION

MUSIC & LIGHTS S.r.l.

Via Appia, km 136,200 - 04020 Itri (LT) - ITALY
Phone +39 0771 72190 - Fax +39 0771 721955

www.musiclights.it - email: info@musiclights.it

ISO 9001:2008 Certified Company

©2017 Music & Lights S.r.l.

PROAUDIO is a brand of Music & Lights S.r.l. company.

PROAUDIO è un brand di proprietà della Music & Lights S.r.l.

