

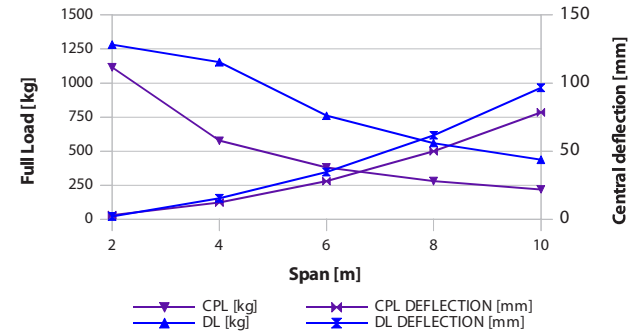

## SF30

### Flat section aluminium truss with 29cm long sides

- Lengthwise: extruded tubes, Ø 50x2 mm 6082 T6
- Diagonal: extruded tubes, Ø 20x2 mm 6082 T6
- Plate: conical quick-lock connectors
- Fast connection kit FCF5 included

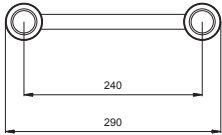
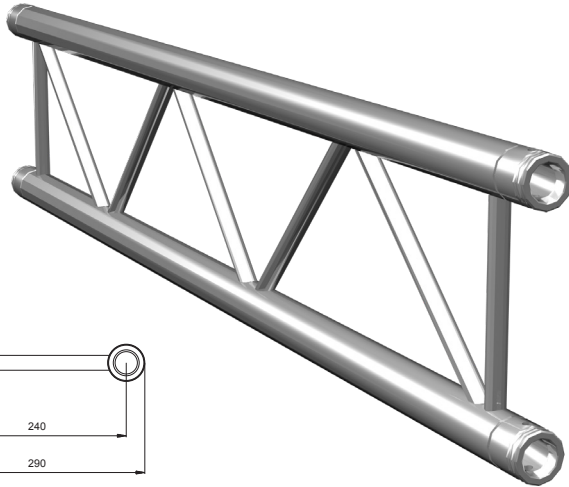

**Distributed Load**

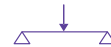

**Centre Point Load**

SPAN [m]	Distributed Load			Centre Point Load	
	Point load [kg/m]	Full load [kg]	Central deflection [mm]	Full load [kg]	Central deflection [mm]
2	640.7	1281.4	2.1	1116	3
4	288.4	1153.6	15.4	576.9	12.3
6	126.7	760.2	34.6	380	27.9
8	70	560	61.7	280.2	49.9
10	43.8	438	96.6	219	78.5

### Variants

Code	Black Vers.	Tube (mm)	Diagonal (mm)	W (cm)	H (cm)	D (cm)	Weight (kg)	Volume (mc)
SF30050	SF30050B	50x2	20x2	50	5	29	1.5	0.007
SF30100	SF30100B	50x2	20x2	100	5	29	2.5	0.015
SF30150	SF30150B	50x2	20x2	150	5	29	3.4	0.022
SF30200	SF30200B	50x2	20x2	200	5	29	4.4	0.029
SF30250	SF30250B	50x2	20x2	250	5	29	5.40	0.036
SF30300	SF30300B	50x2	20x2	300	5	29	6.40	0.044
SF30350	SF30350B	50x2	20x2	350	5	29	7.4	0.051
SF30400	SF30400B	50x2	20x2	400	5	29	8.3	0.058
SF30450	SF30450B	50x2	20x2	450	5	29	9.3	0.065
SF30500	SF30500B	50x2	20x2	500	5	29	10.4	0.073

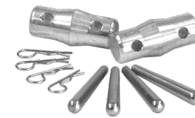

### Included

#### FCF5

Quick connection, 2 spigots, 4 pins, 4 safety spring, SF30/40

### Optional accessories



#### SF30FP

Aluminium ground base for flat section trusses, SF30



## Joints

### Variants

Code	Black Vers.	Type	Way (nr)	Angle	Orient.	Vertex	W (cm)	H (cm)	D (cm)
SF30L2045H	SF30L2045HB	L2	2	45°	horiz.	-	50	5	50
SF30L2045V	SF30L2045VB	L2	2	45°	vertical	-	50	29	50
SF30L2060H	SF30L2060HB	L2	2	60°	horiz.	-	50	5	50
SF30L2060V	SF30L2060VB	L2	2	60°	vertical	-	50	29	50
SF30L2090H	SF30L2090HB	L2	2	90°	horiz.	-	50	5	50
SF30L2090V	SF30L2090VB	L2	2	90°	vertical	-	50	29	50
SF30L2120H	SF30L2120HB	L2	2	120°	horiz.	-	50	5	50
SF30L2120V	SF30L2120VB	L2	2	120°	vertical	-	50	29	50
SF30L2135H	SF30L2135HB	L2	2	135°	horiz.	-	50	5	50
SF30L2135V	SF30L2135VB	L2	2	135°	vertical	-	50	29	50
SF30L3V	SF30L3VB	L3	3	90°	vertical	-	50	50	50
SF30L3H	SF30L3HB	L3	3	90°	horiz.	-	50	50	50
SF30T3V	SF30T3VB	T3	3	90°	vertical	-	50	50	50
SF30T3H	SF30T3HB	T3	3	90°	horiz.	-	50	50	50
SF30X4H	SF30X4HB	X4	4	90°	horiz.	-	50	5	50
SF30X4V	SF30X4VB	X4	4	90°	vertical	-	50	29	50
SF30T4H	SF30T4HB	T4	4	90°	horiz.	-	50	50	50
SF30T4V	SF30T4VB	T4	4	90°	vertical	-	50	50	50
SF30L4090H	SF30L4090HB	L4	4	90°	horiz.	-	50	50	50
SF30L4090V	SF30L4090VB	L4	4	90°	vertical	-	50	50	50



SF30L2045V



SF30L2120H



SF30L3V

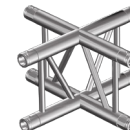

SF30X4V

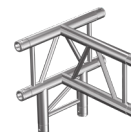

SF30T4V

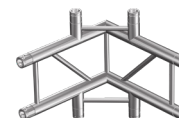

SF30L4090V

## Circular Trusses

### Variants

Code	Black Vers.	Orient.	Vertex	D.Ext (cm)	D.Int. (cm)	H (cm)	D (cm)	Weight (kg)	Arch num
	SF30C200VB	vertical	-	200	190	29	5	8.60	4
SF30C300V	SF30C300VB	vertical	-	300	290	29	5	13	4
SF30C400V	SF30C400VB	vertical	-	400	390	29	5	17.40	4
SF30C500V	SF30C500VB	vertical	-	500	490	29	5	21.80	8
SF30C600V	SF30C600VB	vertical	-	600	590	29	5	26.20	8
SF30C200H	SF30C200HB	horiz.	-	200	190	29	5	8.60	4
SF30C300H	SF30C300HB	horiz.	-	300	290	29	5	13	4
SF30C400H	SF30C400HB	horiz.	-	400	390	29	5	17.40	4
SF30C500H	SF30C500HB	horiz.	-	500	490	29	5	21.80	8
SF30C600H	SF30C600HB	horiz.	-	600	590	29	5	26.20	8

## Orientation



VERTICAL



HORIZONTAL

### flat section circular aluminium truss structure with 30cm sides

- Lengthwise: extruded tubes, Ø 50x2 mm 6082 T6
- Diagonal: extruded tubes, Ø 25x2 mm 6082 T6
- Plate: conical quick-lock connectors
- x4 Fast connection kits FCF5 included