



SQ30

Square section aluminium truss with 29cm long sides

- Lengthwise: extruded tubes, Ø 50x2 mm 6082 T6
- Diagonal: extruded tubes, Ø 20x2 mm 6082 T6
- Plate: conical quick-lock connectors
- Fast connection kit FCQ5 included

CERTIFIED BY

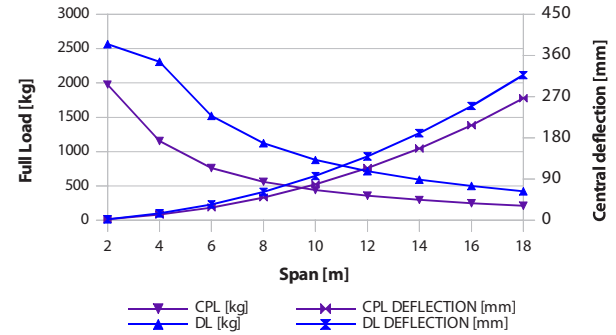
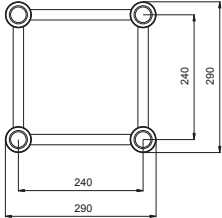
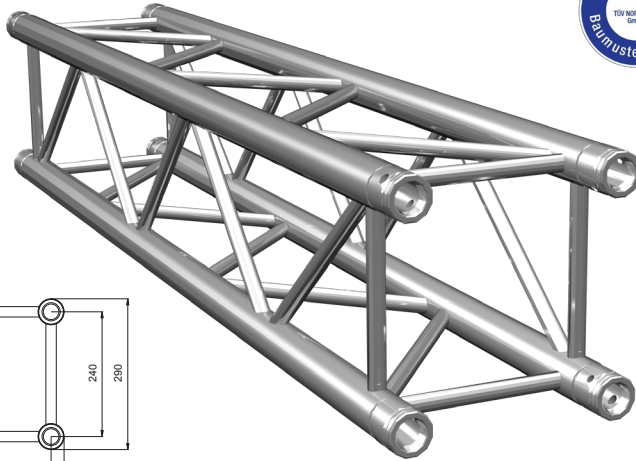

SPAN [m]	Distributed Load			Centre Point Load	
	Point load [kg/m]	Full load [kg]	Central deflection [mm]	Full load [kg]	Central deflection [mm]
2	1281.6	2563.2	2.1	1976	2.3
4	577.1	2308.4	15.4	1154.2	12.3
6	253.5	1521	34.6	760.6	27.9
8	140.3	1122.4	61.7	561.1	49.8
10	87.9	879	96.6	439.3	78.5
12	59.4	712.8	139.4	356.3	114.1
14	42.2	590.8	190.4	295.6	157
16	31.1	497.6	249.7	248.6	207.7
18	23.4	421.2	317.3	211	266.6

Variants

Code	Black Vers.	Tube (mm)	Diagonal (mm)	W (cm)	H (cm)	D (cm)	Weight (kg)	Volume (mc)
SQ30050	SQ30050B	50x2	20x2	50	29	29	4	0.042
SQ30100	SQ30100B	50x2	20x2	100	29	29	6	0.084
SQ30150	SQ30150B	50x2	20x2	150	29	29	8.5	0.126
SQ30200	SQ30200B	50x2	20x2	200	29	29	10.9	0.168
SQ30250	SQ30250B	50x2	20x2	250	29	29	13.1	0.210
SQ30300	SQ30300B	50x2	20x2	300	29	29	15.5	0.252
SQ30350	SQ30350B	50x2	20x2	350	29	29	17.8	0.294
SQ30400	SQ30400B	50x2	20x2	400	29	29	19.6	0.336
SQ30450	SQ30450B	50x2	20x2	450	29	29	22	0.378
SQ30500	SQ30500B	50x2	20x2	500	29	29	24.3	0.421



Included
FCQ5

Quick connection, 4 spigots, 8 pins, 8 safety spring, SQ-HQ30/40



Joins

Variants

Code	Black Vers.	Type	Way (nr)	Angle	Orient.	Vertex	W (cm)	H (cm)	D (cm)
SQ30L2045	SQ30L2045B	L2	2	45°	-	-	50	29	50
SQ30L2060	SQ30L2060B	L2	2	60°	-	-	100	29	100
SQ30L2090	SQ30L2090B	L2	2	90°	-	-	50	29	50
SQ30L2120	SQ30L2120B	L2	2	120°	-	-	50	29	50
SQ30L2135	SQ30L2135B	L2	2	135°	-	-	50	29	50
SQ30L3	SQ30L3B	L3	3	90°	-	-	50	50	50
SQ30T3	SQ30T3B	T3	3	90°	-	-	50	29	50
SQ30T4	SQ30T4B	T4	4	90°	-	-	50	50	50
SQ30T5	SQ30T5B	T5	5	90°	-	-	50	50	50
SQ30K8	SQ30K8B	K8	6	90°	-	-	29	29	29

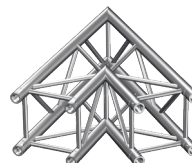

SQ30L2045

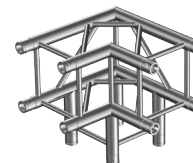

SQ30L3

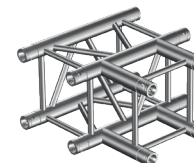

SQ30T3

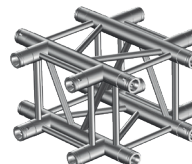

SQ30X4

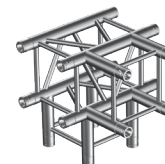

SQ30T4

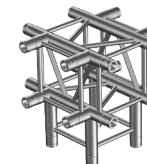

SQ30T5

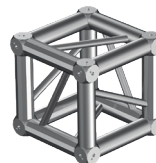

SQ30K8

Circular Trusses

Variants

Code	Black Vers.	Orient.	Vertex	D.Ext (cm)	D.Int. (cm)	H (cm)	D (cm)	Weight (kg)	Arc num
SQ30C200	SQ30C200B	-	-	200	142	29	29	7.60	4
SQ30C300	SQ30C300B	-	-	300	242	29	29	11.90	4
SQ30C400	SQ30C400B	-	-	400	342	29	29	16,0	4
SQ30C500	SQ30C500B	-	-	500	442	29	29	20.70	8
SQ30C600	SQ30C600B	-	-	600	542	29	29	25.10	8
SQ30C700	SQ30C700B	-	-	700	642	29	29	29.50	8
SQ30C800	SQ30C800B	-	-	800	742	29	29	33.90	8
SQ30C900	SQ30C900B	-	-	900	842	29	29	38.30	12
SQ30C1000	SQ30C1000B	-	-	1000	942	29	29	42.70	12

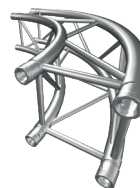

Square section circular aluminium truss structure with 30cm sides

- Lengthwise: extruded tubes, Ø 50x2 mm 6082 T6
- Diagonal: extruded tubes, Ø 25x2 mm 6082 T6
- Plate: conical quick-lock connectors
- x4 Fast connection kits FCQ5 included

Optional accessories

FCQ5K8

Quick connection, 4 h/spigot, 4 pins, 4 safety spring, HQ-SQ30/40K8



SQ30FP

Aluminium ground base for square section trusses, SQ-HQ30,