



## ST30

### Triangular section aluminium truss with 29cm long sides

- Lengthwise: extruded tubes, Ø 50x2 mm 6082 T6
- Diagonal: extruded tubes, Ø 20x2 mm 6082 T6
- Plate: conical quick-lock connectors
- Fast connection kit FCT5 included

CERTIFIED BY

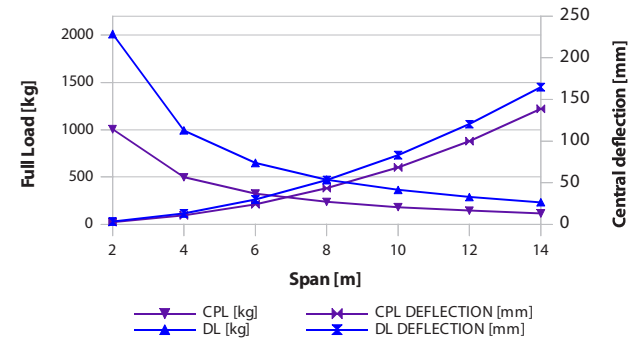
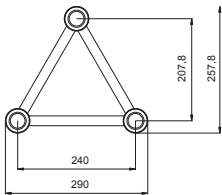
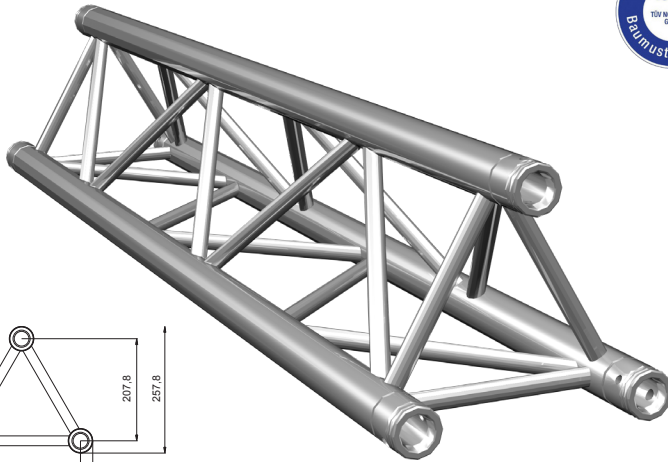

#### Distributed Load

#### Centre Point Load

SPAN [m]	Distributed Load			Centre Point Load	
	Point load [kg/m]	Full load [kg]	Central deflection [mm]	Full load [kg]	Central deflection [mm]
2	1005.5	2011	3.3	1005.5	2.6
4	248.3	993.2	13.2	496.7	10.6
6	108.1	648.6	29.7	324.4	24
8	59.1	472.8	53	236.2	43.2
10	36.3	363	83.2	181.7	68.3
12	24	288	120.3	144	100
14	16.6	232.4	164.7	116	138.8

### Variants

Code	Black Vers.	Tube (mm)	Diagonal (mm)	W (cm)	H (cm)	D (cm)	Weight (kg)	Volume (mc)
ST30050	ST30050B	50x2	20x2	50	29	29	3.4	0.018
ST30100	ST30100B	50x2	20x2	100	29	29	5.7	0.036
ST30150	ST30150B	50x2	20x2	150	29	29	8	0.055
ST30200	ST30200B	50x2	20x2	200	29	29	11.5	0.073
ST30250	ST30250B	50x2	20x2	250	29	29	12.6	0.091
ST30300	ST30300B	50x2	20x2	300	29	29	14.9	0.109
ST30350	ST30350B	50x2	20x2	350	29	29	17.2	0.127
ST30400	ST30400B	50x2	20x2	400	29	29	19.5	0.146
ST30450	ST30450B	50x2	20x2	450	29	29	21.8	0.164
ST30500	ST30500B	50x2	20x2	500	29	29	24.1	0.182



#### Included

#### FCT5

Quick connection, 3 spigots, 6 pins, 6 safety spring, ST30/40

#### Optional accessories

#### ST30FP

Aluminium ground base for triangular section trusses, ST30





## Joists

### Variants

Code	Black Vers.	Type	Way (nr)	Angle	Orient.	Vertex	W (cm)	H (cm)	D (cm)
ST30L2045U	ST30L2045UB	L2	2	45°	-	up	50	29	50
ST30L2060U	ST30L2060UB	L2	2	60°	-	up	50	29	50
ST30L2090U	ST30L2090UB	L2	2	90°	-	up	50	29	50
ST30L2090E	ST30L2090EB	L2	2	90°	-	external	50	29	50
ST30L2090I	ST30L2090IB	L2	2	90°	-	internal	50	29	50
ST30L2120U	ST30L2120UB	L2	2	120°	-	up	50	29	50
ST30L2135U	ST30L2135UB	L2	2	135°	-	up	50	29	50
ST30L3RU	ST30L3RUB	L3	3	90°	right	up	50	50	50
ST30L3LU	ST30L3LUB	L3	3	90°	left	up	50	50	50
ST30L3RD	ST30L3RDB	L3	3	90°	right	down	50	50	50
ST30L3LD	ST30L3LDB	L3	3	90°	left	down	50	50	50
ST30T3LD	ST30T3LDB	T3	3	90°	left	down	50	50	50
ST30T3LE	ST30T3LEB	T3	3	90°	left	external	50	50	50
ST30T3LU	ST30T3LUB	T3	3	90°	left	up	50	50	50
ST30T3D	ST30T3DB	T3	3	90°	-	down	50	50	50
ST30T3U	ST30T3UB	T3	3	90°	-	up	50	50	50
ST30X4U	ST30X4UB	X4	4	90°	-	up	50	50	50
ST30X4LD	ST30X4LDB	X4	4	90°	left	down	50	50	50
ST30X4RD	ST30X4RDB	X4	4	90°	right	down	50	50	50
ST30T4D	ST30T4DB	T4	4	90°	-	down	50	50	50
ST30T4U	ST30T4UB	T4	4	90°	-	up	50	50	50
ST30T5U	ST30T5UB	T5	5	90°	-	up	50	50	50
ST30X5U	ST30X5UB	X5	5	90°	-	up	50	50	50
ST30X5D	ST30X5DB	X5	5	90°	-	down	50	50	50
ST30X6D	ST30X6DB	X6	6	90°	-	down	50	50	50



ST30L2090U



ST30T4U

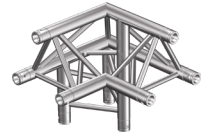

ST30L3LU

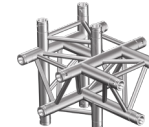

ST30T5U

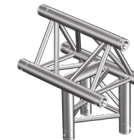

ST30T3U



ST30X5U

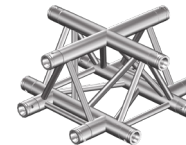

ST30X4U

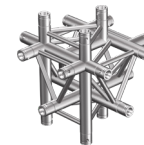

ST30X6D

## Circular Trusses

### Variants

Code	Black Vers.	Orient.	Vertex	D.Ext (cm)	D.Int. (cm)	H (cm)	D (cm)	Weight (kg)	Arch num
ST30C200U	ST30C200UB	-	up	200	142	29	29	7.60	4
ST30C300U	ST30C300UB	-	up	300	242	29	29	11.90	4
ST30C400U	ST30C400UB	-	up	400	342	29	29	16.30	4
ST30C500U	ST30C500UB	-	up	500	442	29	29	20.70	8
ST30C600U	ST30C600UB	-	up	600	542	29	29	25.10	8
ST30C200I	ST30C200IB	-	internal	200	142	29	29	7.60	4
ST30C300I	ST30C300IB	-	internal	300	242	29	29	11.90	4
ST30C400I	ST30C400IB	-	internal	400	342	29	29	16.30	4
ST30C500I	ST30C500IB	-	internal	500	442	29	29	20.70	8
ST30C600I	ST30C600IB	-	internal	600	542	29	29	25.10	8
ST30C200E	ST30C200EB	-	external	200	142	29	29	7.60	4
ST30C300E	ST30C300EB	-	external	300	242	29	29	11.90	4
ST30C400E	ST30C400EB	-	external	400	342	29	29	16.30	4
ST30C500E	ST30C500EB	-	external	500	442	29	29	20.70	8
ST30C600E	ST30C600EB	-	external	600	542	29	29	25.10	8

## Vertex



UPPER

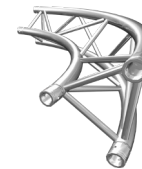

INTERNAL



EXTERNAL

Triangle section circular aluminium truss structure with 30cm sides

- Lengthwise: extruded tubes, Ø 50x2 mm 6082 T6
- Diagonal: extruded tubes, Ø 25x2 mm 6082 T6
- Plate: conical quick-lock connectors
- x4 Fast connection kits FCT5 included