

Photometric Test Report



SUNRISE2IP

IP rated modular LED blinder with 2x120
LED WW and Tungsten emulation

CONTENTS

Table of contents	2
Testing process	3
Color preset Full on	
Native Optic	4

TESTING PROCESS

Prolights has its own optical testing laboratory in order to provide accurate photometric reports for its lighting products. The testing laboratory contains certain variety of precise lighting measurement systems that ensure an optimal reading of all the characteristic parameters of the lighting devices. All measurements are made at a controlled room temperature of 20°C without any external light sources. This photometric report is obtained through the data measured by a high precision measurement system and analyzed by a dedicate software.

Prolights measurement instrument

Prolights measurement instrument is a complete measurement system for any light source. It's equipped with two-axis goniometer, that enables to measure the full 3D distribution field of the light source. This instrument measures the light intensity, the beam angle and the most significative colors parameters, like color temperature, spectral distribution, CRI, CQS, TM-30 with a very high accuracy rate.

Please Note: All measurements are made with light source at operating temperature. Before starting the measurement, the instrument analyzes the process of the light source during the heating phase. The measuring process of all the parameters begins only when the light emission is stable, that is with a variation of less than 0.5% in a 15 minutes time frame.

Prolights measurement software

The software provides user friendly interface for the operator who does the measurements, and it also analyzes and processes all the collected data by the instrument. With this software it is possible to see the measured data in real-time and it is possible to examine all the measured data and graphics afterwards as well. All information is collected in a specific Prolights template, and the software creates also IES and LDT files, which are widely used to transfer the photometric data, and to develop lighting system.

Additionally, the fixtures are rechecked using various hand-held instruments like Sekonic C-700 and Gossen Mavospec Base, this is done to ensure, that the data in the photometric report are as accurate as possible.



Total lumen output:

10088 lm

Peak candela output:

9682 cd

Light quality:

CRI: 93,0

Color temperature:

2783 K

PRODUCT NAME:

SUNRISE2IP

MEASUREMENT CONDITIONS:

Beam angle:

Native

Target:

Full On

Operator:

Paolo Carvone

Date and time:

15/09/2020 11:48:13

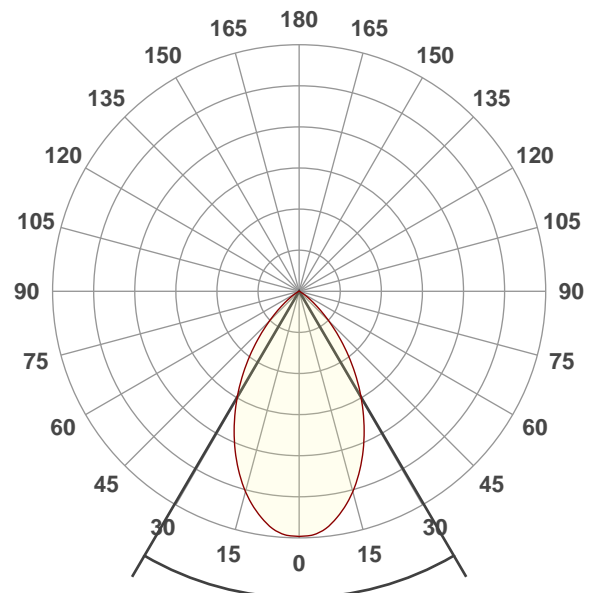

Beam angle 50%: 60,7°

Field angle 10%: 98,9°

Cut off angle 2.5%: 115,5°

Spectra

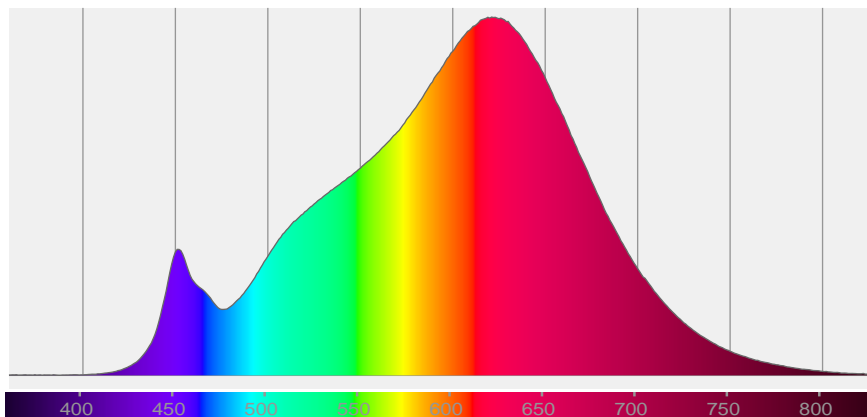

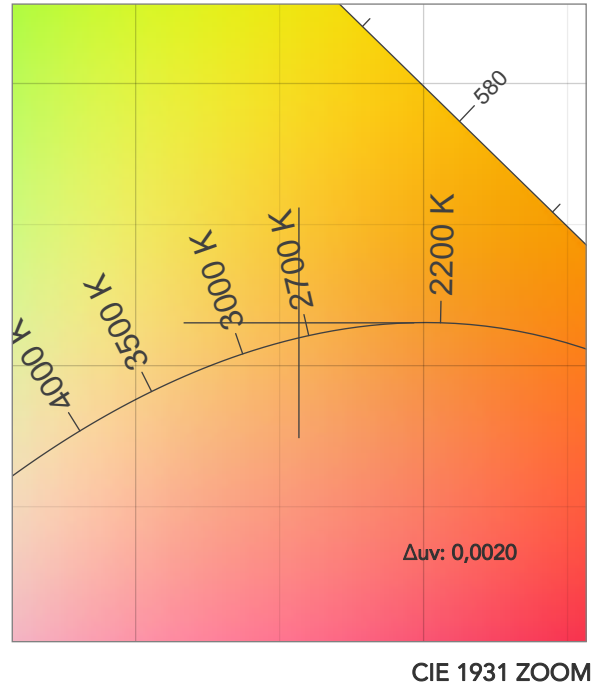
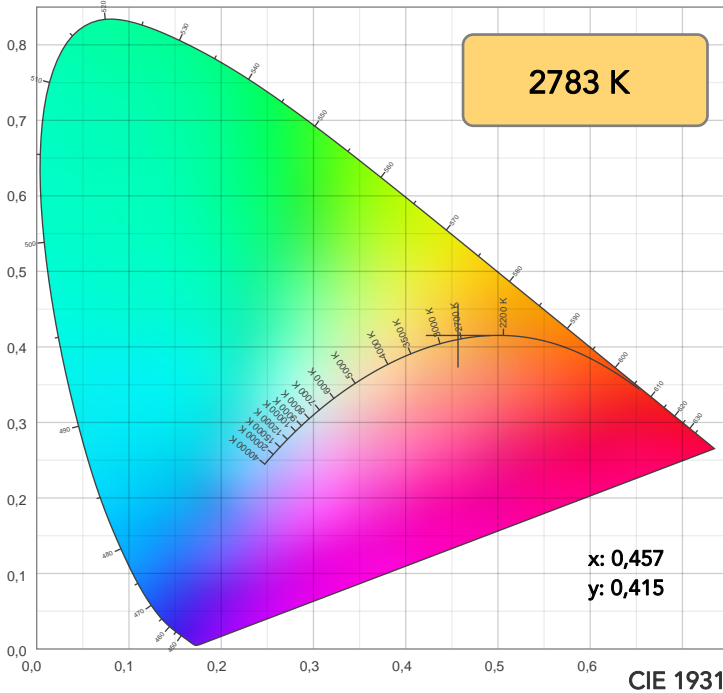

TM30: 91,3

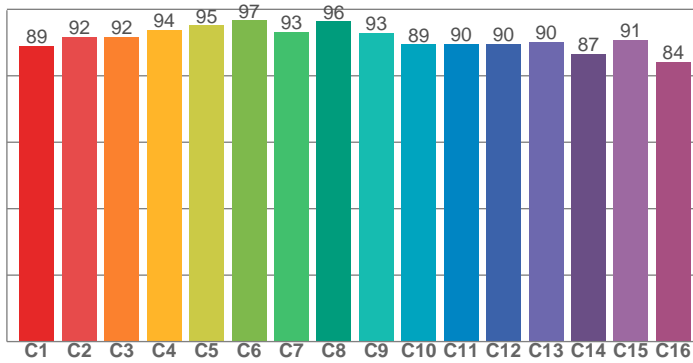

CRI: 93,0 (R1-R8)

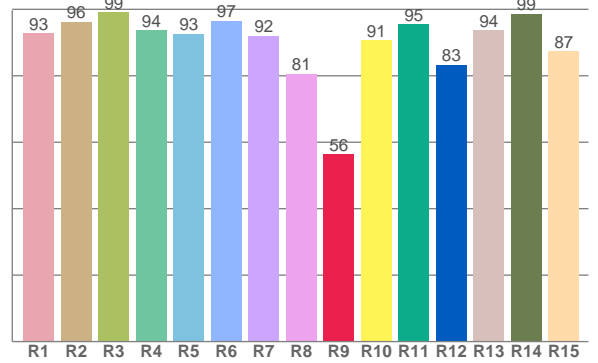

CQS: 91,3

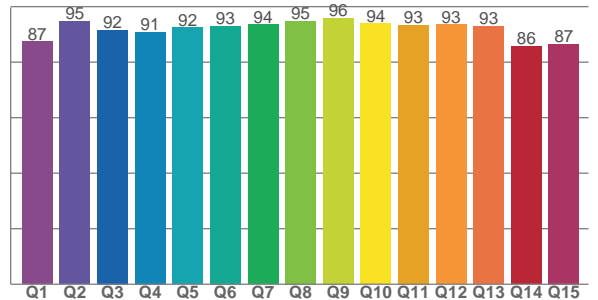

CRI R values, only R1-R8 are used to calculate final CRI value

R1	R2	R3	R4	R5	R6	R7	R8	R9	R10	R11	R12	R13	R14	R15
92,9	96,3	99,1	93,7	92,6	96,6	92,0	80,6	56,3	90,8	95,4	83,3	93,8	98,6	87,3

TM30 C values, 16 binned values out of total of 99 C values

C1	C2	C3	C4	C5	C6	C7	C8	C9	C10	C11	C12	C13	C14	C15	C16
89,0	91,7	91,7	93,9	95,1	96,7	93,2	96,4	92,9	89,5	89,7	89,7	90,2	86,6	90,8	84,2

CQS Q values

Q1	Q2	Q3	Q4	Q5	Q6	Q7	Q8	Q9	Q10	Q11	Q12	Q13	Q14	Q15
87,4	94,7	91,6	90,9	92,4	93,1	93,5	94,8	95,9	93,8	93,4	93,5	92,9	85,7	86,5

COLOR PARAMETERS

Color temperature	Color rendering index	Red component	Color fidelity	Color gamut	Color quality scale	Television lighting index	Color coordinate cie 1931	Color coordinate cie 1931	Color deviation from black body
CCT	CRI	CRI R9	TM30 Rf	TM30 Rg	CQS	TLCI	x	y	Δuv
2783 K	93,0	56,3	91,3	97,4	91,3	91	0,457	0,415	0,0020

TM30 DETAILS

Rf 91,3
Fidelity index Rf

Rg 97,4
Gammut index

Hue Bin	R _f	Graphic shifts (%)	
		Chroma	Hue
1	89	-5%	0%
2	92	-3%	2%
3	92	-2%	3%
4	94	-3%	0%
5	95	-2%	2%
6	97	0%	1%
7	93	-4%	0%
8	96	-1%	2%
9	93	-2%	4%
10	89	-1%	6%
11	90	2%	7%
12	90	4%	-1%
13	90	2%	-6%
14	87	3%	-9%
15	91	-3%	-3%
16	84	-4%	-10%

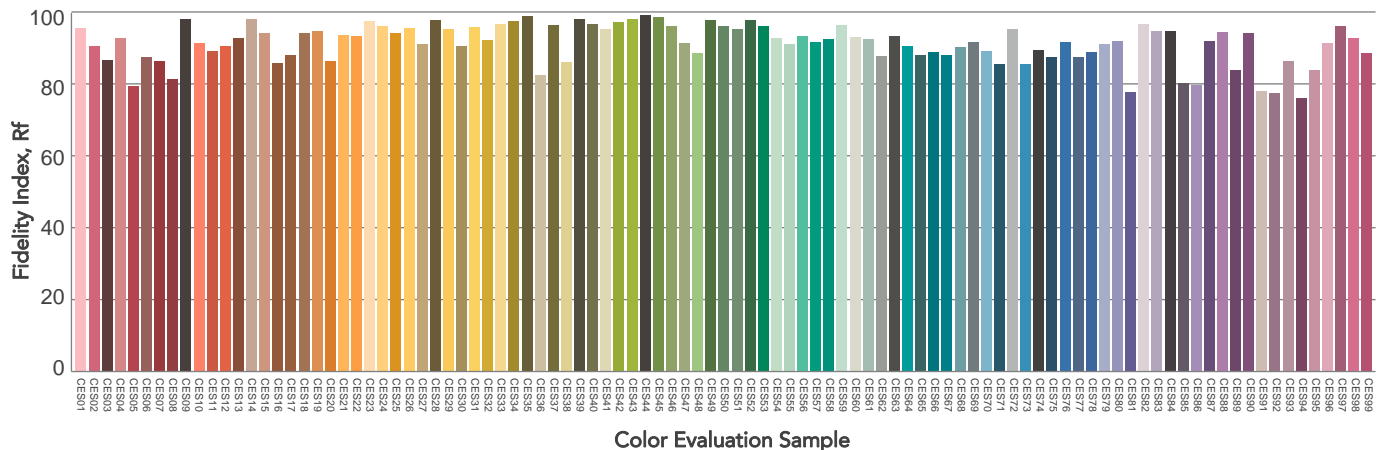
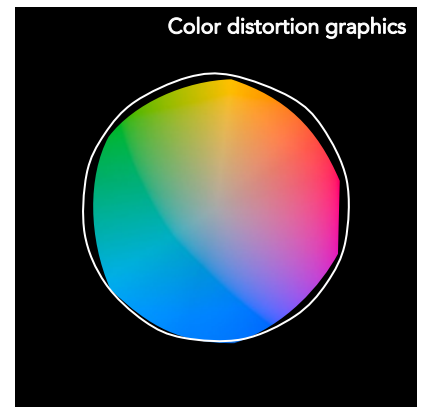
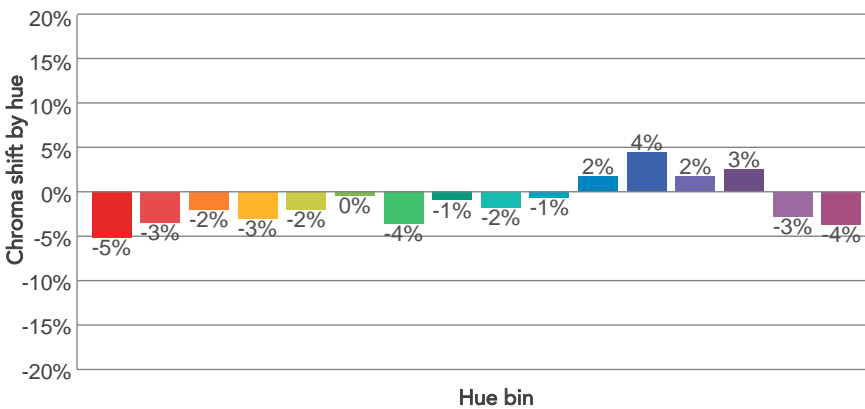
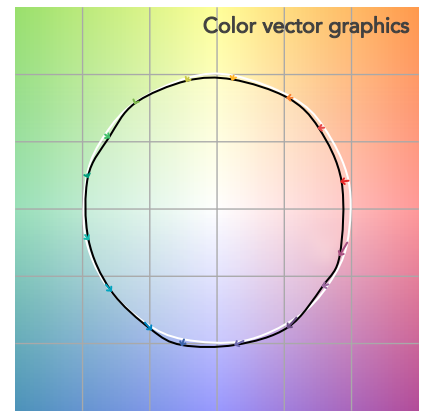
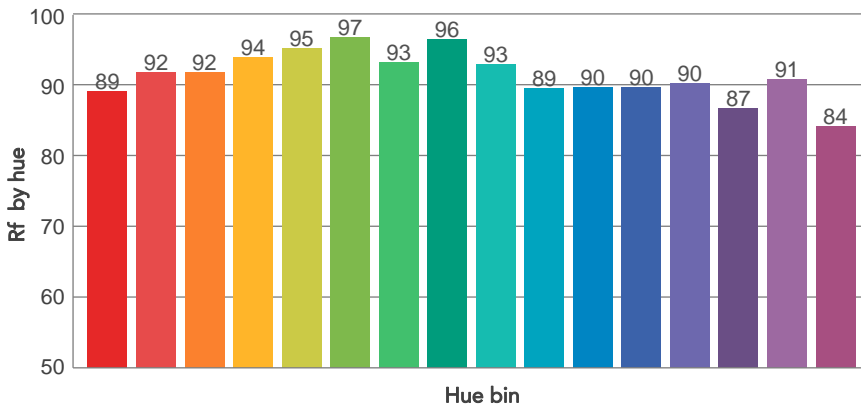
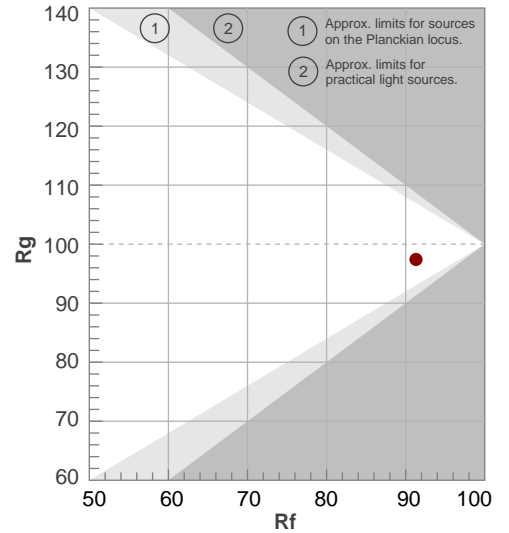

BEAM DETAILS



Beam angle 50%	Field angle 10%	Cut off angle 2,5%	Intensity ratio in 120° cone	Intensity ratio in 90° cone
60,7°	98,9°	115,5°	98,8%	90,0%

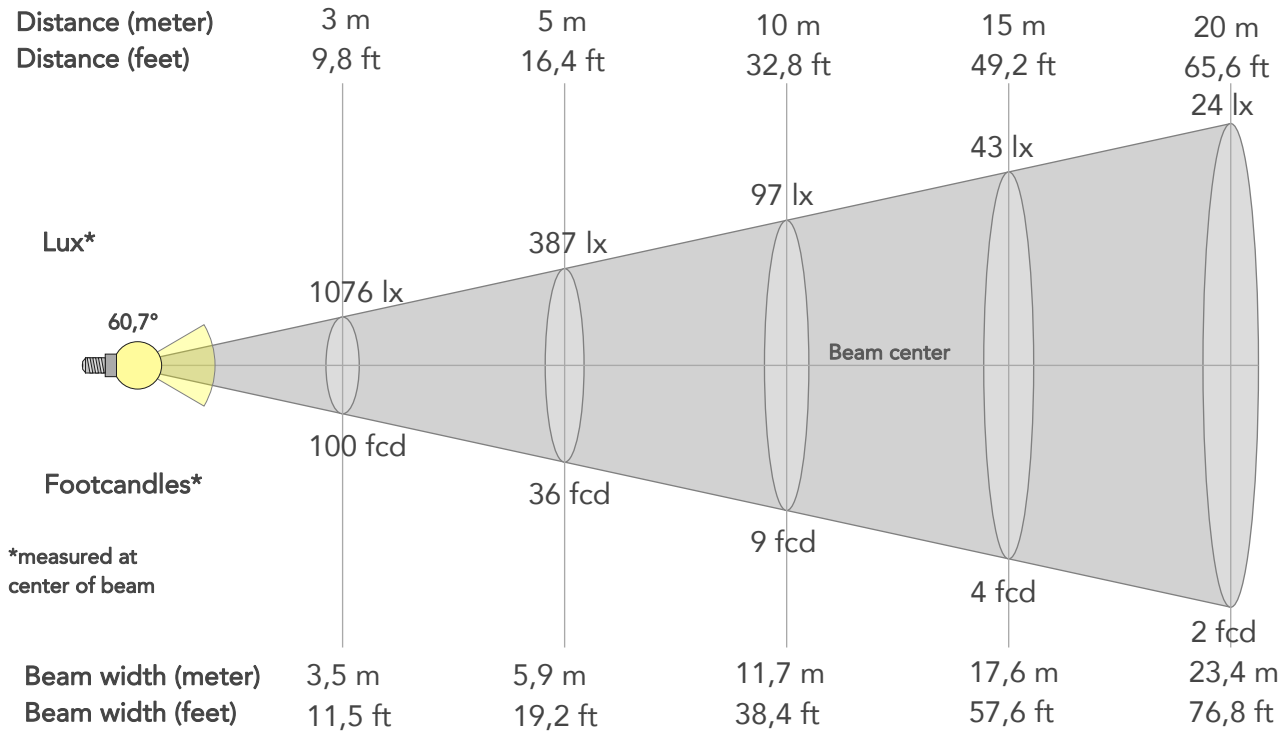

BEAM INTENSITIES AND WIDTHS

Distance	1m	2m	3m	4m	5m	7,5m	10m	15m	20m	25m	30m	40m	50m
Distance	3,3ft	6,6ft	9,8ft	13,1ft	16,4ft	24,6ft	32,8ft	49,2ft	65,6ft	82ft	98,4ft	131,2ft	164ft
Lux	9682lx	2420lx	1076lx	605lx	387lx	172lx	97lx	43lx	24lx	15lx	11lx	6lx	4lx
Footcand.	899fcd	225fcd	100fcd	56fcd	36fcd	16fcd	9fcd	4fcd	2fcd	1fcd	1fcd	1fcd	0fcd
Beam wid.	1,2m	2,3m	3,5m	4,7m	5,9m	8,8m	11,7m	17,6m	23,4m	29,3m	35,1m	46,8m	58,5m
Beam wid.	3,9ft	7,7ft	11,5ft	15,3ft	19,2ft	28,8ft	38,4ft	57,6ft	76,8ft	96ft	115,2ft	153,6ft	191,9ft

LINEAR DISTRIBUTION DIAGRAM

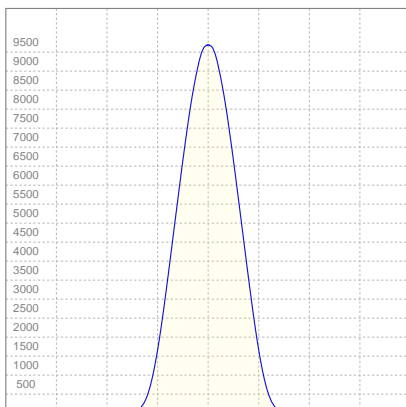

ELECTRICAL SPECIFICATIONS

Input voltage	Input current	Input power	Effeciency
223V	0,660A	138,4W	73lm/W

Power FC
0,94

ISO CANDELA DIAGRAM

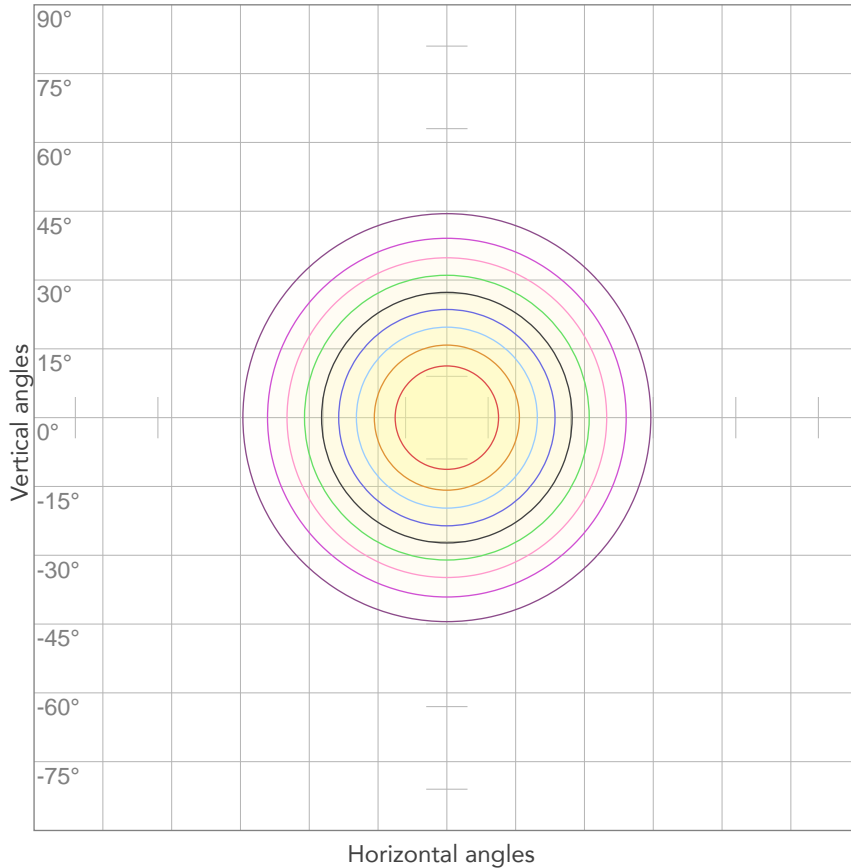

10%	968 cd
20%	1936 cd
30%	2904 cd
40%	3873 cd
50%	4841 cd
60%	5809 cd
70%	6777 cd
80%	7745 cd

Conditions:

Number of c-planes: 2

Candela at center: 9682 cd

ISO LUX DIAGRAM

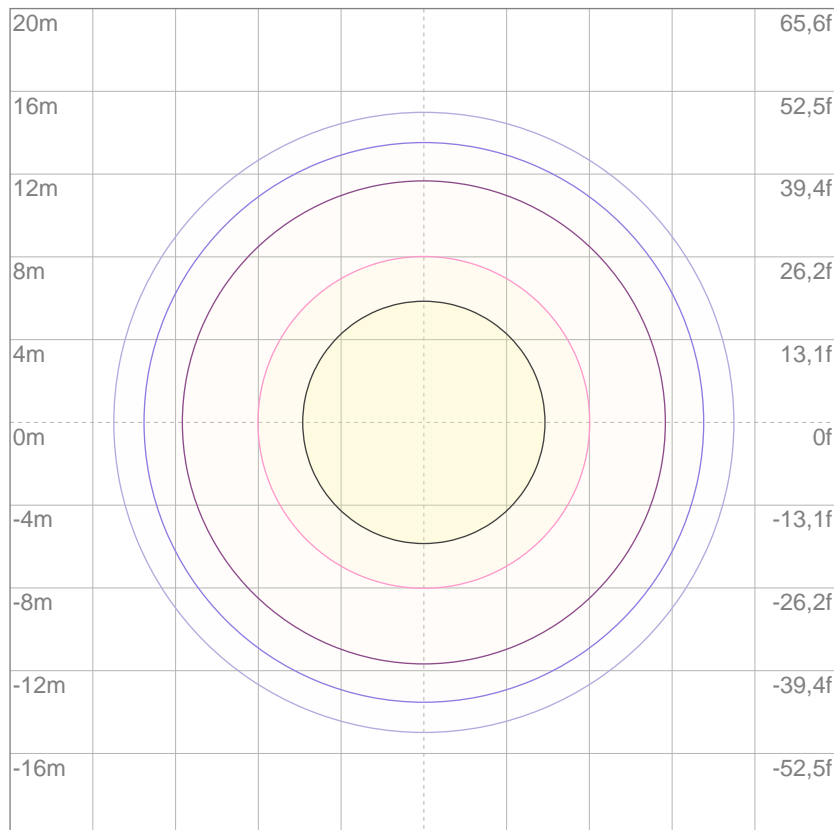

3%	2,90 lx
5%	4,84 lx
10%	9,68 lx
30%	29,0 lx
50%	48,4 lx

Conditions:

Number of c-planes: 2

Lux at center: 96,8 lx

Lux distribution on a surface when lamp is mounted at 10 meters from the surface.

Mounting height: 10 meters (33 feet)