



DATASHEET

PAN AMT P 04-AMT – PASSIVE FULL-RANGE LOUDSPEAKER (D'APPOLITO)



The **Pan AMT P 04-AMT** is a passive line array (D'Appolito) in an attractive compact column design for speech and music applications. The **Pan AMT P 04-AMT** is characterised by a high level of fine detail and excellent resolution even at the highest frequencies.

The loudspeaker contains four 3.5" HQ drivers and a specially developed **AMT tweeter unit from Mundorf**. The enclosure is made of aluminium and can be custom-finished in any colour. The chassis are protected from external impact by a perforated metal sheet that is integrated into the design.

At the back of the **P 04-AMT** there is a 5-pin connector. The optional mounting accessories (wall, ceiling and tripod mounts) can be installed by inserting a slot nut in the lateral slots and the rear slot.

It can be operated individually or in combination with subwoofers from the Pan Subwoofer series.



Illustration in colour option, see properties for details.

EQUIPMENT / OPTIONS



See last page for explanation of the symbols.

APPLICATIONS

Churches, museums, live PA, train stations, airports, sports facilities, legislative buildings, conference rooms, lecture halls, shopping centres, A/V presentation rooms, surround, immersive sound

FEATURES

High efficiency, integrated protection circuit, high reproduction quality even in acoustically challenging environments, sleek and unobtrusive design.

MOUNTING ACCESSORIES

For the **Pan AMT** series, there is a wide range of mounting accessories for fixed installation and mobile use.

All **Pan AMT** loudspeakers are designed, developed and manufactured in Germany by Pan Acoustics according to strict criteria and with high-quality materials.



TECHNICAL DATA P 04-AMT

ACOUSTIC PROPERTIES

Configuration:	Passive full-range loudspeaker (D'Appolito)
Frequency range:	90 Hz - 24 kHz
Equipment:	4 x 3.5" + 1 x Air Motion Transformer (AMT)
Rated power:	300 W (peak _{20ms}) / 200 W (programme) / 100 W (nominal)
Recommended amplifier:	DSP power amplifier at least 600 W @ 4 ohms per channel
Sensitivity:	93 dB 1 W / 1 m
Maximum SPL:	126 dB / 1 m*
Impedance:	4 ohms
Horizontal radiation pattern:	130°
Vertical radiation pattern:	20°
Connections:	1 x Phoenix, 5-pin (optional 1 x NL4 (1+/1-))
Operating temperature:	-10 °C to +50 °C (ambient temperature)

MECHANICAL PROPERTIES

Enclosure:	Aluminium profile
Grille:	Powder-coated perforated metal sheet
Standard colours (with silver lids): (optional: lid in enclosure colour)	RAL 9006 (aluminium), anodized RAL 9010 (white), silk matt RAL 9005 (black), silk matt
Dimensions (H x W x D):	506 x 107 x 118 [mm]
Weight:	3 kg
Mounting option:	Extensive range of mounting accessories available

*Under anechoic half-space conditions with DSP settings.
Frequency range: -10 dB under anechoic halfspace-conditions.



TECHNICAL DRAWING P 04-AMT

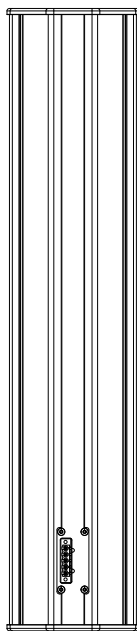
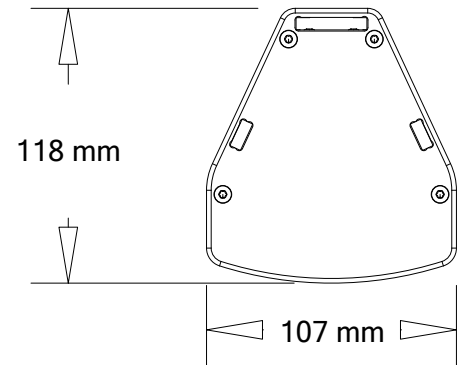
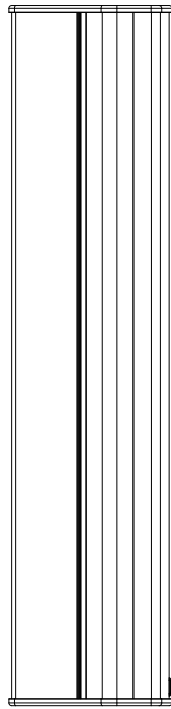
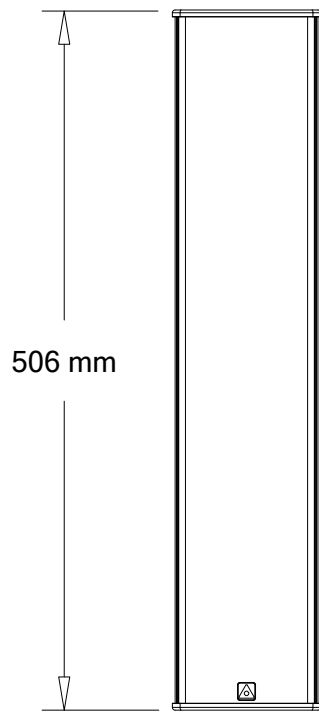

P 04-AMT

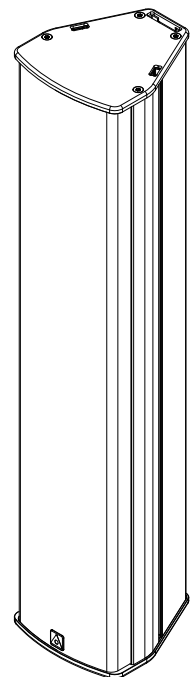



EQUIPMENT / OPTIONS AT GLANCE – PAN AMT SERIES



Customised painting/colouring within the RAL colour range. Other colour systems such as RAL design, Pantone, etc. are available on request.



Accessories such as wall, tripod and ceiling mounts, different interfaces, connection cables, weather protection hoods and connection sets are available.



Ball impact resistance



Looks good, sounds good.

Pan Acoustics' products are defined by natural sound and attractive design.

Some equipment features cannot be combined. For information about which features can be combined with each other, please send an e-mail to sales@pan-acoustics.de

Our quality promise

Pan Acoustics stands by its products and gives up to **10 years warranty** on its loudspeakers for any material or manufacturing defects. New products manufactured in accordance with protection classes IP54 and IP65 as well as digital audio interfaces (Dante®) from Audinate Pty Ltd and rechargeable batteries are excluded from the 10-year warranty. A warranty period of 3 years is granted for loudspeakers in accordance with protection classes IP54 and IP65.

