

# END USER INSTRUCTIONS

*Transmitters:*

*T9-02, T9-12      T11-04, T11-14*

safe

smart

strong

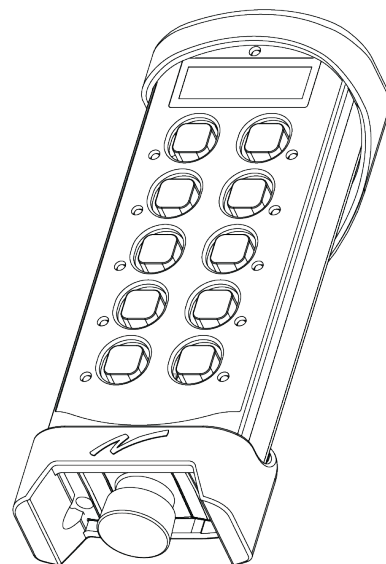
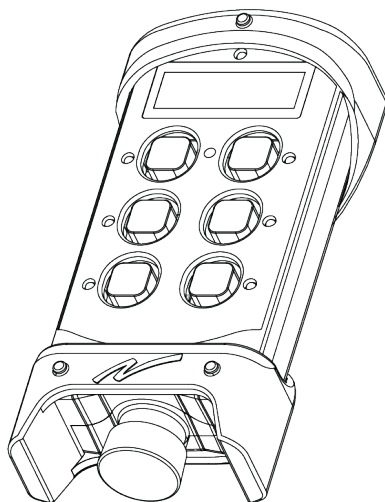

---

**©Tele Radio AB**

Datavägen 21

SE-436 32 Askim

Sweden

Phone: +46 (0)31 748 54 60

---

---

<b>CHAPTER 1: INTRODUCTION</b> .....	<b>5</b>
1.1 About this document .....	7
1.2 About Tiger TG2 systems .....	8
<b>CHAPTER 2: SAFETY</b> .....	<b>9</b>
2.1 Warnings & restrictions .....	9
2.2 Safety features .....	11
<b>CHAPTER 3: TECHNICAL DATA</b> .....	<b>12</b>
3.1 Transmitter specifications .....	12
3.2 Radio frequency band .....	13
<b>CHAPTER 4: PRODUCT GENERAL DESCRIPTION</b> .....	<b>15</b>
4.1 Transmitter front .....	15
4.2 Transmitter back .....	16
4.3 Display and top LED .....	17
<b>CHAPTER 5: STATUS AND ERROR INDICATIONS</b> .....	<b>18</b>
5.1 Top LED status indication .....	18
5.2 Error indications and messages .....	18
<b>CHAPTER 6: OPERATION</b> .....	<b>19</b>
6.1 General information .....	19
6.2 General navigation .....	19
6.3 User permissions .....	20
6.4 Functionality test .....	21
6.5 Start a session (no PIN code) .....	22
6.6 Start a session (PIN code required) .....	24
6.7 Log the transmitter out from a receiver .....	26
6.8 Switch the transmitter off .....	26
<b>CHAPTER 7: BATTERY</b> .....	<b>27</b>
7.1 Battery precautions .....	27
7.2 Battery information .....	29
<b>CHAPTER 8: FOILS</b> .....	<b>33</b>
8.1 Affix a foil to the transmitter .....	33
<b>CHAPTER 9: WARRANTY, SERVICE, REPAIRS, AND MAINTENANCE</b> .....	<b>34</b>
<b>CHAPTER 10: REGULATORY INFORMATION</b> .....	<b>35</b>
10.1 Europe .....	35
10.2 North America .....	36

---

10.3 AEC .....39

**ANNEX A: INDEX .....40**

## CHAPTER 1: INTRODUCTION

### Thank you for using a Tele Radio AB product



**READ ALL INSTRUCTIONS AND WARNINGS CAREFULLY BEFORE OPERATING THE PRODUCTS.**

These End user instructions have been published by Tele Radio AB and are not subject to any warranty. The End user instructions may be withdrawn or revised by Tele Radio AB at any time and without further notice. Corrections and updates will be added to the latest version of the manual. Always download the End user instructions from our website, [www.tele-radio.com](http://www.tele-radio.com), for the latest available version. Keep the safety instructions for future reference.

**IMPORTANT! These instructions are intended for end users. The instructions can be printed and handed to end user.**

Tele Radio AB remote controls are often built into wider applications. This documentation is not intended to replace the determination of suitability or reliability of the product for specific user applications and should not be used for this purpose. It is the responsibility of any such users or integrators to perform the appropriate and complete risk analysis, evaluation and testing of the products with respect to the relevant specific application or use. Tele Radio AB shall not be responsible or liable for misuse of the information contained herein.

Always refer to the applicable local regulations for installation and safety requirements relating to cranes, hoists, material handling applications, lifting equipment, industrial machinery, and/or mobile hydraulic applications using Tele Radio AB products, e.g.:

- applicable local and industrial standards and requirements,
- applicable occupational health and safety regulations,
- applicable safety rules and procedures for the factory where the equipment is being used,
- user and safety manuals or instructions of the manufacturer of the equipment where Tele Radio AB remote control systems are installed.

Tele Radio AB End user instructions do not include or address the specific instructions and safety warnings of the end product manufacturer.

For battery precautions, see "7.1 Battery precautions".

Tele Radio AB products are covered by a warranty against material, construction, or manufacturing faults. See "Chapter 9: Warranty, service, repairs, and maintenance".

## 1.1 About this document

Before installing or operating the product, read the corresponding documentation carefully.

Tele Radio AB's product range is composed of transmitters, receivers, and accessories intended for use together as a system.

These End user instructions cover general safety issues, main technical specifications, standard operating instructions and battery information. Images shown in this document are for illustrative purposes only.

Please report any error or omission in this document, as well as any improvement or amendment suggestion to [td@tele-radio.com](mailto:td@tele-radio.com).

### 1.1.1 COPYRIGHT

Information in this document is subject to change without notice. No part of this publication may be reproduced, stored in a retrieval system, or transmitted in any form or by any means, electronic, photographic, mechanical (including photocopying), recording or otherwise for any purpose other than the purchaser's personal use without the written permission of Tele Radio AB.

### 1.1.2 TERM AND SYMBOL DEFINITIONS

The capitalized terms and symbol used herein shall have the following meaning:

- **WARNING:** indicates a hazardous situation which, if not avoided, could result in death or serious injury.
- **CAUTION:** indicates a hazardous situation which, if not avoided, will result in minor or moderate injury.
- **IMPORTANT:** is used for information that requires special consideration.
- **NOTE:** is used to address practices not related to physical injury.



This symbol is used to call attention to safety messages that would be assigned the signal words "WARNING" or "CAUTION".

## 1.2 About Tiger TG2 systems

The Tiger TG2 product range is composed of transmitters and receivers intended for use together as a system in complex lifting applications such as cranes, OHT cranes and electric hoists or mobile applications.

### 1.2.1 ABOUT T9/T11 TRANSMITTERS

T9/T11 transmitters have simplex communication with support for duplex.

T9/T11 transmitters are compatible with all R4, R9 and R10 receivers within the same frequency range.

#### *Overview of the available models*

Model	Step buttons transmitters Number of buttons				Display	Available frequencies	
	6	8	10	12		433 MHz	915 MHz
T9-02	●				●	●	
T9-12	●				●		●
T11-04			●		●	●	
T11-14			●		●		●

- Standard



## CHAPTER 2: SAFETY

### 2.1 Warnings & restrictions



**Carefully read through the following safety instructions before proceeding with the installation, configuration, operation, or maintenance of the product. Failure to follow these warnings could result in death or serious injury.**

This product must not be operated without having read and understood the End user instructions and having received the appropriate training. The purchaser of this product has been instructed how to handle the system safely. The following information is intended for use as a complement to applicable local regulations and standards.

**IMPORTANT! Tele Radio AB remote controls are often built into wider applications. These systems should be equipped with:**

- a wired emergency stop where necessary
- a brake
- an audible or visual warning signal

#### 2.1.1 OPERATION



**This radio system must not be used in areas where there is a risk of explosion.**



**Only qualified personnel should be permitted to access the transmitter and operate the equipment.**



- **Always follow operating and maintenance instructions as well as all applicable safety procedures and requirements.**
- **Do not open the receiver encapsulation unless you are qualified.**
- **You must satisfy the age requirements in your country for operating the equipment.**
- **It is strictly prohibited to operate the equipment under the influence of drugs, alcohol and/or medications.**
- **Always test the transmitter stop button before operating it. Press the stop button then twist and pull it out. This test should be done on each shift, without a load.**
- **Never use a transmitter if the stop button is mechanically damaged. Contact your supervisor or representative for service immediately.**
- **Never leave the transmitter unattended.**
- **Always switch the transmitter off when not in use. Store in a safe place.**
- **Keep a clear view of the work area at all times.**

### 2.1.2 MAINTENANCE



**Before maintenance intervention on any remote controlled equipments:**

- **always remove all electrical power from the equipment.**
  - **always follow lockout procedures.**
- 
- Keep the safety information for future reference. Always download the End user instructions from our website, [www.tele-radio.com](http://www.tele-radio.com), for the latest available version.
  - If error messages are shown, it is very important to find out what caused them. Contact your representative for help.
  - The functionality of the stop button should be tested at least after every 200 hours' use (see "2.2.1 Stop button").
  - If the stop button is mechanically damaged, do not use the transmitter. Contact your supervisor or representative for service immediately.
  - Keep the product in a clean, dry place.
  - Do not try to open the encapsulation.

- Always contact your representative for service and maintenance work on the product.
- Keep contacts and antennas clean.
- Wipe off dust using a clean, slightly damp cloth.
- Never use cleaning solutions.
- Check the encapsulation, foils and cable for damages every day. If you use the product although the encapsulation or foil is damaged, moisture can cause serious damage to the electronics.

## 2.2 Safety features

### 2.2.1 STOP BUTTON

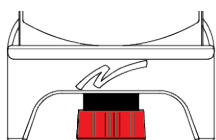

Tele Radio AB transmitters are equipped with a stop button. When the **Stop** button is pressed, the stop relays on the receiver deactivate.

**IMPORTANT! The Stop button should always be tested before operating the transmitter. This test should be done on each shift, without a load.**

To test the stop button:

1. Press the **Stop** button.
2. Twist and release the **Stop** button.

## CHAPTER 3: TECHNICAL DATA

### 3.1 Transmitter specifications

	T9-02	T9-12	T11-04	T11-14
Number of buttons	6 x 2-step buttons		10 x 2-step buttons	
Power supply	Internal, rechargeable lithium-ion		Replaceable, rechargeable lithium-ion	
I/O switch	Yes		No	
Radio communication	Simplex (default), support for duplex			
Max. number of registered receivers	4		8	
Max. number of PIN codes	8		8	
Radio frequency band	433.075– 434.775	903.0125– 926.9875	433.075– 434.775	903.0125– 926.9875
Number of channels	69 (channel 1– 69)	–	69 (channel 1– 69)	–
Number of frequency banks	–	15 (bank 1–15)	–	15 (bank 1–15)
Radio frequency output power	EIRP <sup>1</sup> : < 10 dBm (10 mW)	EIRP: < 0 dBm (1 mW)	EIRP: < 10 dBm (10 mW)	EIRP: < 0 dBm (1 mW)
Operating time (with continuous usage)	Approximately 16 h			
IP code	IP66			
Operating temperature	-20...+55 °C / -4...+130 °F			
Charging temperature	+10...+35 °C / +50...+95 °F			
Display	LCD 45.3 x 14.6 mm (1.78 x 0.57 in) Resolution: 128 x 32 px Monochrome with backlight sensor			
Safety levels	EN 61508 SIL3 and EN ISO 13849 PLe (Stop function)			
Dimensions	160 x 76 x 37 mm / 6.3 x 3 x 1.4 in		210 x 76 x 37 mm / 8.2 x 3 x 1.4 in	
Weight	295 g / 0.6 lbs		400 g / 0.9 lbs	

<sup>1</sup>Equivalent isotropic radiated power

## 3.2 Radio frequency band

### 3.2.1 433 MHz

For radio systems operating on frequency band 433 MHz, the frequency band is divided into 69 channels (channel 1-69). Once the channel has been selected on the transmitter, the receiver will automatically detect and switch to the same channel.

Channel	Frequency (MHz)	Channel	Frequency (MHz)	Channel	Frequency (MHz)
01	433.075	26	433.700	51	434.325
02	433.100	27	433.725	52	434.350
03	433.125	28	433.750	53	434.375
04	433.150	29	433.775	54	434.400
05	433.175	30	433.800	55	434.425
06	433.200	31	433.825	56	434.450
07	433.225	32	433.850	57	434.475
08	433.250	33	433.875	58	434.500
09	433.275	34	433.900	59	434.525
10	433.300	35	433.925	60	434.550
11	433.325	36	433.950	61	434.575
12	433.350	37	433.975	62	434.600
13	433.375	38	434.000	63	434.625
14	433.400	39	434.025	64	434.650
15	433.425	40	434.050	65	434.675
16	433.450	41	434.075	66	434.700
17	433.475	42	434.100	67	434.725
18	433.500	43	434.125	68	434.750
19	433.525	44	434.150	69	434.775
20	433.550	45	434.175		
21	433.575	46	434.200		
22	433.600	47	434.225		
23	433.625	48	434.250		
24	433.650	49	434.275		
25	433.675	50	434.300		

### 3.2.2 915 MHZ

Radio systems operating on frequency band 915 MHz use frequency-hopping spread spectrum (FHSS) to communicate. The frequency band is divided into 15 frequency banks (1-15). Frequency bank 1 is selected by default.

To establish a radio link between the receiver and the transmitter, both units must be configured to use the same frequency bank. Contact your representative for assistance.

## CHAPTER 4: PRODUCT GENERAL DESCRIPTION

The pictures shown in this chapter are for illustrative purposes only.

### 4.1 Transmitter front

T9-02, T9-12

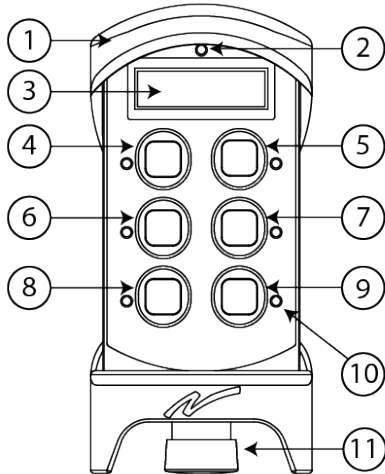

T11-04, T11-14

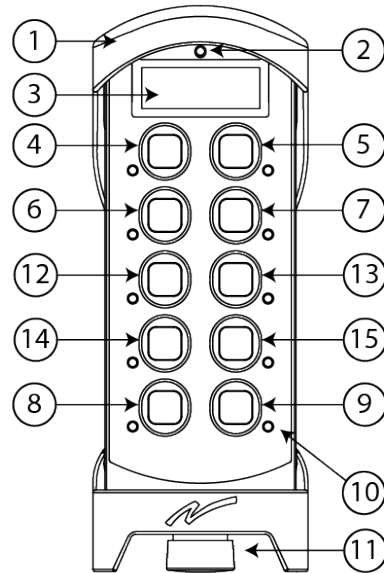

1. Rubber cover

2. Top LED

3. LCD display

4. Button 1

5. Button 2

6. Button 3

7. Button 4

8. **Left Start** button<sup>1</sup>

9. **Right Start** button<sup>2</sup>

10. Button LEDs

11. **Stop** button

12. Button 7

13. Button 8

14. Button 9

15. Button 10

<sup>1</sup>T9: button 5; T11: button 9.

<sup>2</sup>T9: button 6; T11: button 10.

## 4.2 Transmitter back

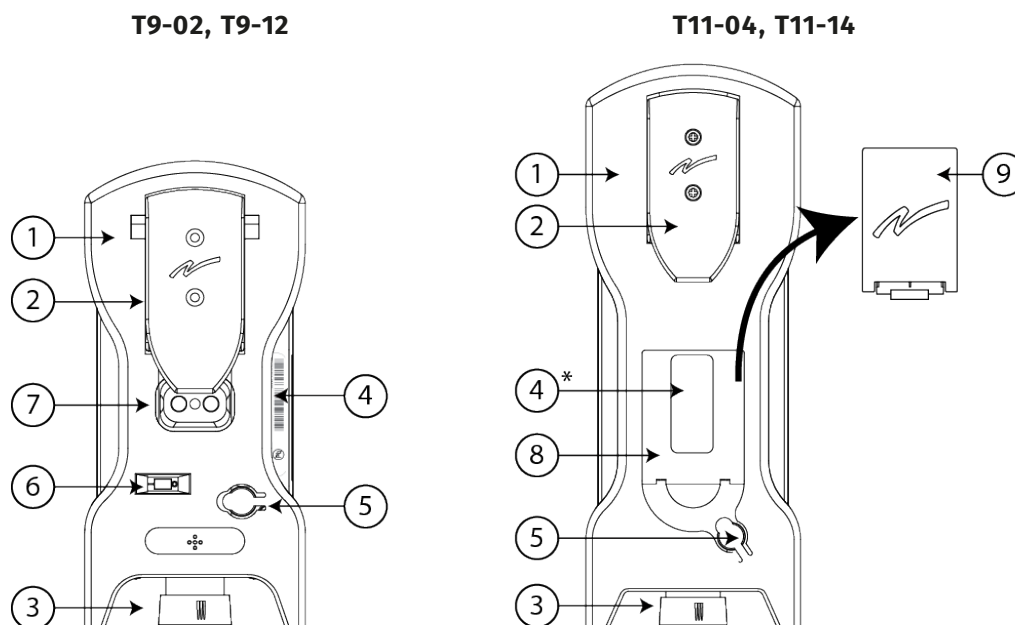

- |                       |                               |   |
|-----------------------|-------------------------------|---|
| 1. Rubber cover       | 4. Product label <sup>1</sup> | 7. Charger contacts for Tele Radio AB holders |
| 2. Clip               | 5. Battery charger socket     | 8. Battery compartment                        |
| 3. <b>Stop</b> button | 6. I/O switch                 | 9. Replaceable battery                        |

### 4.2.1 I/O SWITCH (T9 MODELS ONLY)

The I/O switch on the back of the transmitter interrupts the power supply from the battery. When in the O/off position, the transmitter cannot be started unless the charger plug is connected.

**IMPORTANT! When the transmitter is to be transported by air, the I/O switch must be in the O/off position.**

**NOTE:** The I/O switch should not be used as an on/off button for the transmitter. To start and stop the transmitter, use the **Stop** button.

<sup>1</sup>\*On T11 models, the product label is placed inside the battery compartment.







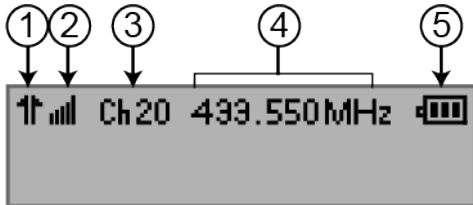

## 4.3 Display and top LED

### 4.3.1 LCD DISPLAY

The transmitter display is intended for receiving and visualizing feedback information from the system as well as for basic configuration. The transmitter display is controlled by the transmitter's joystick and side buttons.



- |  |  |   |
|--|--|---|
| <p>1. Radio communication<br/>  Simplex<br/>  Duplex</p> | <p>2. Signal strength</p> <p>3. Channel number</p> <p>4. Operating frequency</p> | <p>5. Battery level indication<sup>1</sup></p> <p>100 % </p> <p>50 % </p> <p>33 % </p> <p>17 % </p> <p>0 % </p> |
|--|--|---|

### 4.3.2 TOP LED

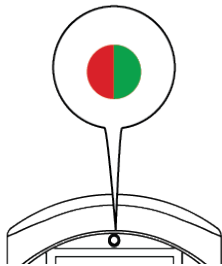

The transmitter is equipped with one bi-color LED (top LED) for battery indication and radio link information. For more details, see "Chapter 5: Status and error indications"

<sup>1</sup>Approximate values with a new, fully charged battery.

## **CHAPTER 5: STATUS AND ERROR INDICATIONS**

### **5.1 Top LED status indication**

The top LED lights or flashes green when the battery capacity is good and red when the battery capacity is poor. When the top LED lights/flashes red, battery should be charged or changed at the next convenient opportunity (see "7.2.2 Charge the battery").

### **5.2 Error indications and messages**

Please write down or take a picture of the error message shown on the display and contact your representative for assistance.

## CHAPTER 6: OPERATION

### 6.1 General information

To control a receiver, the transmitter must be registered and logged in to the receiver. If another transmitter is already logged in to the receiver, it must be logged out before a different transmitter can be logged in.

If no transmitter is logged in to the receiver, proceed with the login procedure before using the system. Once a transmitter has been logged in, it will remain logged in until it is manually logged out.

More than one transmitter can be registered in the receiver, but only one transmitter can be logged in at a time.

### 6.2 General navigation

The Menu system is controlled by buttons **1–4** and by the **Left** and **Right Start** buttons.

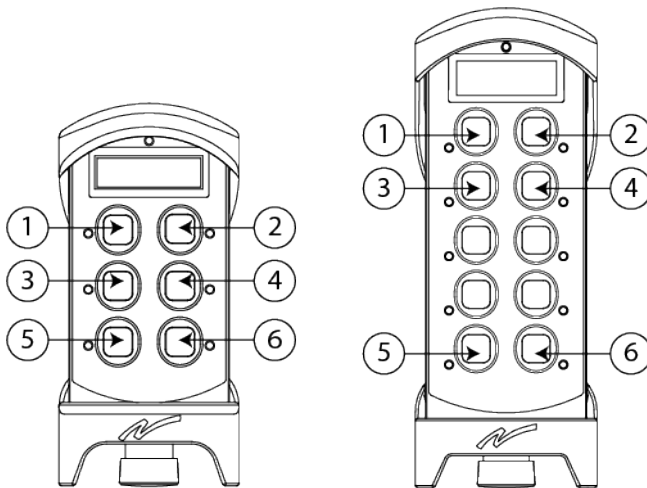

1. **Down**

2. **Up**

3. **Left**

4. **Right**

5. **Left Start** button<sup>1</sup> (Exit)

6. **Right Start** button<sup>2</sup> (Select)

<sup>1</sup>T9: button 5; T11: button 9.

<sup>2</sup>T9: button 6; T11: button 10.

### 6.2.1 MAIN MENU

Buttons	Action
<b>Left Start</b> button (Select)	Enter the selected menu
<b>Right Start</b> button (Exit)	Exit <b>Menu mode</b> and turn the transmitter off
<b>3</b>	Back
<b>1-2</b>	Move between the menu items

### 6.2.2 ENTER NUMBERS / CHANGE VALUES

Buttons	Action
<b>Left Start</b> button (Select)	Accept the updated value
<b>3-4</b>	Move between the digits
<b>1-2</b>	Increase/decrease the value displayed

## 6.3 User permissions

**Setting protection** or **Start-up protection** can be activated to prevent unauthorized personnel from accessing the configuration menus and/or from starting the transmitter. If **Setting protection** or **Start-up protection** has been activated, the transmitter will require a PIN code each time it is restarted. The transmitter will only start after a valid PIN code has been entered.

## 6.4 Functionality test

**NOTE:** This list is intended for use as a support for the manufacturer of the equipment where Tele Radio AB remote control systems are installed.

Before operating the radio system, follow the procedure below.

**IMPORTANT! This test should be performed at each shift, without a load, and should include but not be limited to the following steps**

- Make sure that the controlled object can not cause any harm in the event of unexpected movement.
- Always follow local safety rules and start the equipment according to the corresponding instructions.
- Make sure that the transmitter can control the receiver by testing all functions.
- Make sure that the functions respond as expected.
- Make sure that all movements are as planned.
- Make sure that the stop button works correctly.
- Make sure that the stop function works correctly.
- Make sure the system stops when both batteries are removed from the transmitter.

## 6.5 Start a session (no PIN code)

**To be able to control a receiver with the transmitter, the transmitter must be registered in the receiver.** If no receiver is registered, the display will show [No receivers] [Press Menu + Stop] after the stop button has been pulled out.



**When not in use, transmitters must be switched off and stored in a secure storage space.**



**Do not use the system if the stop button is damaged or if it does not stop the equipment. Doing so could result in serious injury or death.**

NOTE: If no action is taken within 3 minutes after the **Stop** button has been released, the transmitter will turn off. Press the **Stop** button before making a new attempt to start the transmitter.

NOTE: The last accessed receiver(s) will automatically be selected the next time the transmitter is started.

1. Make sure that the **Stop** button is pressed.
2. Twist and release the **Stop** button.  
*The top LED lights. The receiver(s) selected in the last session are indicated by the corresponding red lit LED.*  
**T9:** The display shows: [Start by pressing 5+6]; **T11:** The display shows: [Start by pressing 9+10].  
 Go to step 4 to log in to the previously selected receiver, go to step 3 to select another receiver.  
 If no receiver is selected, the red LEDs for all available receivers will flash and the display will show [Select receiver(s)].
3. Press the button(s) corresponding to the receiver(s) to operate.  
*The respective red LEDs stop flashing and remain lit.*  
*The display shows: **T9:** The display shows: [Start by pressing 5+6]; **T11:** The display shows: [Start by pressing 9+10].*  
 To cancel, press the same button(s) again. The corresponding red LEDs start flashing and the display shows [Select receiver(s)].
4. Press and hold both **Start** buttons simultaneously.  
*The buzzer emits a beep.*

5. Release both **Start** buttons.

*The buzzer stops, the top LED flashes. The display shows: [Logging in...].*

Once a radio link has been established, the top LED stops flashing and remains lit, the selected receivers red LEDs go out and the stop relays activate.

6. Proceed with the functional test (see "6.4 Functionality test").

If not successfully completed, the display will show [LOGIN FAILED]

[ANOTHER TX IS LOGGED IN]. Go back to step 1 and try again.

If no radio link is established within 25 seconds, the transmitter will turn off. Go back to step 1 and try again.

## 6.6 Start a session (PIN code required)

**To be able to control a receiver with the transmitter, the transmitter must be registered in the receiver.** If no receiver is registered, the display will show [No receivers] [Press Menu + Stop] after the stop button has been pulled out.



**When not in use, transmitters must be switched off and stored in a secure storage space.**



**Do not use the system if the stop button is damaged or if it does not stop the equipment. Doing so could result in serious injury or death.**

NOTE: If no action is taken within 3 minutes after the **Stop** button has been released, the transmitter will turn off. Press the **Stop** button before making a new attempt to start the transmitter.

NOTE: The last accessed receiver(s) will automatically be selected the next time the transmitter is started.

1. Make sure that the **Stop** button is pressed.
2. Twist and release the **Stop** button.  
*The top LED lights. The display shows: [Enter PIN].*
3. Enter the PIN code (4 digits). Use the buttons according to the following table.

Digit	T9 models	T11 models
1	Button 1	Button 1
2	Button 2	Button 2
3	Button 3	Button 3
4	Button 4	Button 4
5	-	Button 5
6	-	Button 6
7	-	Button 7
8	-	Button 8

**T9:** *The display shows:* [Start by pressing 5+6]; **T11:** *The display shows:* [Start by pressing 9+10].



Go to step 5 to log in to the previously selected receiver, go to next step to select another receiver.

If no receiver is selected, the red LEDs for all available receivers will flash.

The display will show [Select receiver(s)].

4. Press the button(s) corresponding to the receiver(s) to operate.

*The respective red LEDs stop flashing and remain lit. **T9:** The display shows:*

*[Start by pressing 5+6]; **T11:** The display shows: [Start by pressing 9+10]*

To cancel, press the same button again.

5. Press and hold both **Start** buttons simultaneously.

*The buzzer emits a beep.*

6. Release both **Start** buttons.

*The buzzer stops beeping. The top LED flashes. The display shows: [Logging in].*

When a radio link has been established, the top LED stops flashing and remains lit, the selected receivers red LEDs go out and the stop relays activate.

7. Proceed with the functional test (see "6.4 Functionality test").

If no radio link is established within 25 seconds, the transmitter will turn off. Go back to step 1 and try again.

## 6.7 Log the transmitter out from a receiver

A transmitter already logged in to the receiver has to be logged out before any other transmitter can be logged in. If a transmitter has been lost or seriously damaged, use the replace procedure on the transmitter.

NOTE: Logout can only be performed when the transmitter is on and a radio link with one or more receivers has been established. The receiver must be powered-up for the logout procedure to be successful.

NOTE: The logout procedure will log the transmitter out from all receivers that are part of the radio session.

### 6.7.1 QUICK LOGOUT

1. Make sure that the transmitter is started. If not, twist and release the **Stop** button.
2. Press and hold the **left Start** button.<sup>1</sup>
3. Press the **Stop** button.  
*The top LED lights (red).*
3. Release the **left Start** button.  
The transmitter takes approximately 3 seconds to logout.  
If successfully completed, the display shows [Logout OK]. The transmitter turns off.

## 6.8 Switch the transmitter off

NOTE: When the transmitter is switched off, it remains logged in to the receiver(s). To logout, see "6.7 Log the transmitter out from a receiver"

When the transmitter is active and the stop button is pressed, all relays on the receiver deactivate.

1. Press the **Stop** button.  
*The display shows: [Stopping].*  
*The transmitter turns off. All relays on the receiver deactivate.*

---

<sup>1</sup>T9: button 5; T11: button 9.

## CHAPTER 7: BATTERY

### 7.1 Battery precautions

Carefully read the following safety instructions and warnings before using, charging or disposing of the batteries.



Batteries contain flammable substances such as lithium or other organic solvents, which may result in overheating, rupture or combustion. Failure to read and follow the below instructions may result in fire, personal injury and damage to property if charged or used improperly.

#### 7.1.1 HANDLING AND STORAGE



- Risk of explosion if battery is replaced with a battery of an incorrect type.
- Do not short-circuit, disassemble, deform or heat batteries.
- Never attempt to charge a visibly damaged or frozen battery.
- Do not use or charge the battery if it appears to be leaking, deformed or damaged in any way.
- Do not solder directly onto batteries.
- Do not leave the battery in the charger once it is fully charged.
- Store in a cool location. Keep batteries away from direct sunlight, high temperature, and high humidity.
- Immediately discontinue use of the battery if, while using, charging, or storing the battery, the battery emits an unusual smell, feels hot, changes color, changes shape, or appears abnormal in any other way.
- Keep batteries out of reach of small children. Should a child swallow a battery, consult a physician immediately.

### 7.1.2 DISPOSAL

When discarding batteries, insulate the + and - terminals of batteries with insulating/ masking tape.



- **Do not place multiple batteries in the same plastic bag.**
- **Do not incinerate or dispose of batteries in fire.**
- **Do not place used batteries in the household waste. Dispose of used batteries in accordance with the applicable regulations and legal requirements.**
- **Batteries that have been disposed of incorrectly may short circuit, causing them to become hot, burst or ignite.**

## 7.2 Battery information

NOTE: Only batteries approved by Tele Radio AB should be used in T9/T11 transmitters.

NOTE: When the battery capacity reaches approximately 10 %, the top LED lights red.

	<b>T9-02, T9-12</b>	<b>T11-04, T11-14</b>
Type of battery	Internal, rechargeable lithium-ion battery	Replaceable, rechargeable lithium-ion battery
Article number	-	M245060
Operating time	~ 16 h with continuous usage	
Charge	Charger plug on the back of the transmitter	- Charger plug on the back of the transmitter or
Charger <sup>1</sup>	Tele Radio AB AC adapter	- Charger unit Tele Radio AB charger unit together with Tele Radio AB AC adapter
Article number	M769780	M769755 + M769780
Charging time	Approximately 4 hours with an empty battery	
Charging temperature	+10...+35 °C / +50...+95 °F	
Long term storage temperature	-5...+35 °C (+23...+95 °F)	

<sup>1</sup>Must be purchased separately.

### 7.2.1 REMOVAL OF THE INTERNAL BATTERY (T9)

Electronics and batteries must be physically separated before disposal.

1. Remove the clip. Use a screwdriver to remove the screws.
2. Remove the rubber cover by hand.
3. Use a screwdriver to remove the screws in the back of the transmitter.
4. Gently pull to release the back encapsulation (black).
5. Remove the back encapsulation by hand.
6. Turn it over so the circuit board is facing upwards.
7. Use a screwdriver to remove the screw(s) on the circuit board.
8. Unplug connectors, if any.
9. Gently lift up the circuit board by hand. The battery pack is located behind the circuit board.
10. Remove the battery by hand.

## 7.2.2 CHARGE THE BATTERY

**NOTE:** For T9 transmitters, the 1/O switch must be in the 1/on position when charging.

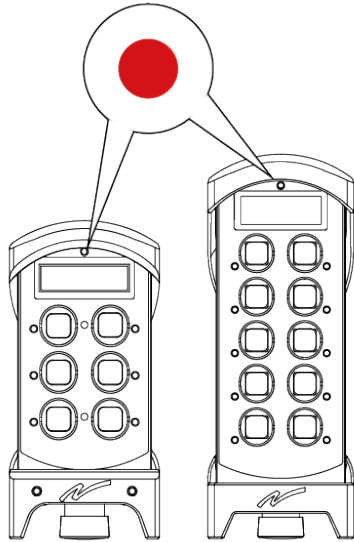

1. When the battery capacity reaches approximately 10 %, the top LED lights red and the internal buzzer beeps 3 times.

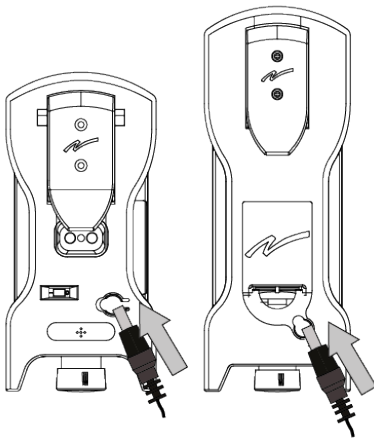

2. Lift the protection cap and insert the charger plug into the socket on the back of the transmitter. The top LED flashes red while the battery is charging.

If the transmitter has a replaceable rechargeable battery, it can be removed and recharged using the Tele Radio AB charger unit, see below.

Charger unit:

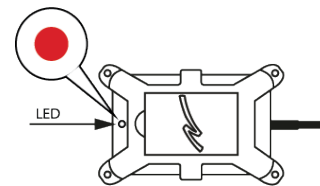

The charger's LED lights red while the battery is charging.

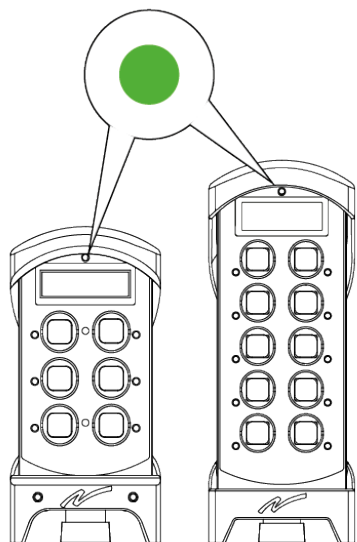

3. The top LED turns green when the battery is fully charged,.

Charger unit:

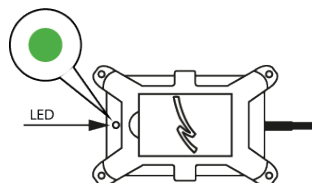

The charger's LED turns green when the battery is fully charged.

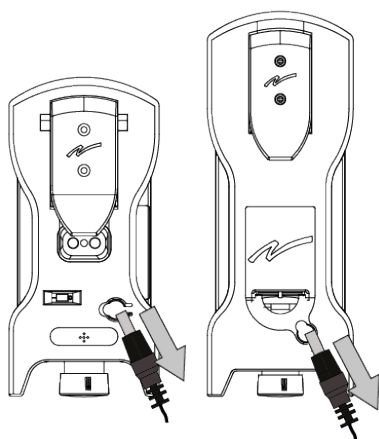

4. Remove the charger plug and close the protection cap.

For external batteries, remove the battery from the charger unit and put it back in the transmitter.



## CHAPTER 8: FOILS

Foils are used to customized transmitters depending on the application. Tele Radio AB foils are made of durable, soft, flexible GO-PU/SM polyurethane film with a semi-matt surface on the front side.

Before affixing a foil to a transmitter, read the recommendation below.

- To obtain optimum adhesion, the bonding surfaces must be clean, dry and well unified. Some typical surface cleaning solvents are isopropyl alcohol (99.5%) or heptane.

**NOTE:** Carefully read and follow the manufacturer's precautions and directions for use when working with solvents. These cleaning recommendations may not be compliant with the rules of certain Air Quality Management Districts in California; consult applicable rules before use.

- Ideal tape application temperature range is 21 °C to 38 °C ( 70 °F to 100 °F).
- Initial tape application to surfaces at temperatures below 10 °C (50 °F) is not recommended because the adhesive becomes too firm to adhere readily. However, once properly applied, low temperature holding is generally satisfactory.

### 8.1 Affix a foil to the transmitter

1. Wipe the front of the transmitter with rubbing alcohol or other appropriate cleaner that won't leave any residue.
2. Dry with a clean cloth.
3. Peel off one side of the backing paper.
4. Position the side of the foil on the corresponding side of the transmitter.
5. While holding onto the side, gently press the foil onto the surface from the side out to the center.
6. Peel away the rest of the backing paper .
7. Slowly apply the other side of the foil, gently press from the center to the end.
8. Inspect the foil. If you see loose areas or bubbles, the surface probably wasn't warm or clean enough. Press the foil firmly against the surface to ensure good adhesion.

## CHAPTER 9: WARRANTY, SERVICE, REPAIRS, AND MAINTENANCE

Tele Radio AB products are covered by a warranty against material, construction and manufacturing faults. During the warranty period, Tele Radio AB may replace the product or faulty parts. Work under warranty must be performed by Tele Radio AB or by an authorized service center specified by Tele Radio AB.

The following are **not** covered by the warranty:

- Faults resulting from normal wear and tear
- Parts of a consumable nature
- Products that have been subject to unauthorized modifications
- Faults resulting from incorrect installation and use
- Damp and water damage

### Maintenance

Repairs and maintenance must be performed by qualified personnel

Only use spare parts from Tele Radio AB

Contact your representative for service or any other assistance

Keep the product in a clean, dry place

Keep contacts and antennas clean

Wipe off dust using a slightly damp, clean cloth

**NOTE:** Never use cleaning solutions or high-pressure washer.

## CHAPTER 10: REGULATORY INFORMATION

NOTE: Models including additional naming conventions:

Model	Article names	Additional naming conventions
<b>T9</b>	<b>T9-02</b>	T9-2, T00009-02, TG-T9-2, TG-T9-02
	<b>T9-12</b>	T00009-12, TG-T9-12
<b>T11</b>	<b>T11-04</b>	T11-4, T00011-04, TG-T11-4, TG-T11-04
	<b>T11-14</b>	T00011-14, TG-T11-14

### 10.1 Europe

Applies to:

- **T9-02**
- **T11-04**

#### 10.1.1 CE MARKING

Hereby, Tele Radio AB, declares that the radio equipment type(s) listed above is/ are in compliance with the Radio Equipment Directive 2014/53/EU.

The latest version of the complete EU Declaration of Conformity is available on the Tele Radio AB website, [www.tele-radio.com](http://www.tele-radio.com).

#### 10.1.2 WEEE DIRECTIVE



This symbol means that inoperative electrical and electronic products must not be mixed with household waste. The European Union has implemented a collection and recycling system for which producers are responsible. For proper treatment, recovery and recycling, please take this product to a designated collection point.

Tele Radio AB strives to minimize the use of hazardous materials, promotes reuse and recycling, and reduces emissions to air, soil and water. When a commercially viable alternative is available, Tele Radio AB strives to restrict or eliminate substances and materials that pose an environmental, health or safety risk.

## 10.2 North America

Applies to:

- **T9-12**
- **T11-14**

### 10.2.1 FCC STATEMENT

This device complies with part 15 of the FCC Rules. Operation is subject to the following two conditions:

- (1) This device may not cause harmful interference, and
- (2) this device must accept any interference received, including interference that may cause undesired operation.

Changes or modifications not expressly approved by the party responsible for compliance could void the user's authority to operate the equipment.

This equipment has been tested and found to comply with the limits for a Class B digital device, pursuant to part 15 of the FCC Rules. These limits are designed to provide reasonable protection against harmful interference in a residential installation. This equipment generates uses and can radiate radio frequency energy and, if not installed and used in accordance with the instructions, may cause harmful interference to radio communications. However there is no guarantee that interference will not occur in a particular installation. If this equipment does cause harmful interference to radio or television reception, which can be determined by turning the equipment off and on, the user is encouraged to try to correct the interference by one or more of the following measures:

- Reorient or relocate the receiving antenna.
- Increase the separation between the equipment and receiver.
- Connect the equipment into an outlet on a circuit different from that to which the receiver is connected.
- Consult the dealer or an experienced radio/TV technician for help.

To satisfy FCC RF exposure requirements, a separation distance of 20 cm or more should be maintained between the antenna of this device and persons during device operation.

To ensure compliance, operations at closer than this distance is not recommended.

The radio module in this product is labelled with its own FCC ID and IC number. The FCC ID and IC is not visible when the radio module is installed inside another

device. Therefore, the outside of the device into which the module is installed must also display a label referring to the radio module. The final end device must be labelled in a visible area with the following:

“Contains FCC ID: ONFC1108B”

“Contains IC: 4807A-C1108B”

Or

“Contains FCC ID: ONFC1203B”

“Contains IC: 4807A-C1203B”

### 10.2.2 IC STATEMENT

This product complies with Industry Canada's licence-exempt RSSs. Operation is subject to the following two conditions:

- (1) This device may not cause interference; and
- (2) This device must accept any interference, including interference that may cause undesired operation of device.

Le présent appareil est conforme aux CNR d'Industrie Canada applicables aux appareils radio exempts de licence. L'exploitation est autorisée aux deux conditions suivantes :

1. l'appareil ne doit pas produire de brouillage;
2. l'appareil doit accepter tout brouillage radioélectrique subi, même si le brouillage est susceptible d'en compromettre le fonctionnement.

To satisfy IC RF exposure requirements, a separation distance of 20 cm or more should be maintained between the antenna of this device and persons during device operation. To ensure compliance, operations at closer than this distance is not recommended.

Afin d'assurer la conformité aux exigences de la IC en matière d'exposition aux RF, une distance de séparation d'au moins 20 cm doit être maintenue entre l'antenne de cet appareil et toute personne à proximité pendant le fonctionnement de l'appareil. Pour assurer le respect de ces exigences, il n'est pas recommandé d'utiliser l'appareil à une distance inférieure à celle-ci.

The radio module in this product is labelled with its own FCC ID and IC number. The FCC ID and IC is not visible when the radio module is installed inside another device. Therefore, the outside of the device into which the module is installed must also display a label referring to the radio module. The final end device must be labeled in a visible area with the following:

Le module radio est étiqueté avec sa propre identification FCC et son propre numéro de certification IC. L'identification FCC et le numéro de certification IC ne sont pas visibles lorsque le module est installé à l'intérieur d'un autre dispositif, c'est la raison pour laquelle la partie externe du dispositif dans lequel le module est installé doit également présenter une étiquette faisant référence au module inclus. Le produit final doit être étiqueté sur une zone visible avec les informations suivantes :

“Contains FCC ID: ONFC1108B”

“Contains IC: 4807A-C1108B”

Or/ ou

“Contains FCC ID: ONFC1203B”

“Contains IC: 4807A-C1203B”

### 10.2.3 FCC/IC LABELS

The radio module in this product is labeled with its own FCC ID and IC numbers. The FCC ID and IC numbers are not visible when the radio module is installed inside another device. Therefore, the outside of the device into which the module is installed must also display a label referring to the enclosed radio module. The final end device must be labeled in a visible area with the following:

“Contains FCC ID: ONFC1104A”

“Contains IC: 4807A-C1104A”

The FCC and IC numbers are found on the product label.

### 10.2.4 RADIO MODULE

The following products described in these instructions contain the radio modules:

<b>PRODUCT</b>	<b>RADIO MODULE</b>
T9-12, T11-14	D00005-06

## 10.3 AEC

Applies to:

- **T9-02**
- **T11-04**

### 10.3.1 AEC STATEMENT (ДЕКЛАРАЦИЯ ЕАС)

This product is declared as compliant within Eurasian Economic Union (EAC). EAC declaration is available on request.

## ANNEX A: INDEX

### A

AEC Statement .....	39
---------------------	----

### B

#### Battery

Battery information .....	29
Charge .....	31
Removal of internal battery .....	30
Battery precautions .....	27
Handling .....	27
Storage .....	27

### C

Charging temperature .....	12, 29
----------------------------	--------

### D

Dimensions .....	12
Display specifications .....	12
Disposal .....	28

### F

FCC statement .....	36
FCC/IC labels .....	38
Foils .....	33
Functionality test .....	21

### I

IC Statement .....	37
IP code .....	12

### L

LCD display .....	17
-------------------	----



---

Log out .....	26
Quick logout .....	26
<b>M</b>	
M245060 .....	29
Maintenance .....	34
Menu navigation .....	19
<b>N</b>	
Number of channels .....	12
Number of frequency banks .....	12
<b>O</b>	
Operating temperature .....	12
Operating time .....	12
<b>P</b>	
Power supply .....	12
<b>R</b>	
Radio communication .....	12
Radio frequency band .....	12
433 MHz .....	13
915 MHz .....	14
Frequency channels .....	13
Radio frequency output power .....	12
Radio module .....	38
<b>S</b>	
Safety Features .....	11
Safety levels .....	12
Start a session .....	22
Start with PIN code .....	24

Start the transmitter .....	22
Start with PIN code .....	24
Stop button .....	11
Storage temperature	
Battery .....	29
Switch off .....	26
<b>T</b>	
Top LED .....	17-18
Transmitter back .....	16
Transmitter display .....	17
Transmitter front views .....	15
<b>U</b>	
User permission .....	20
<b>W</b>	
Warnings & restrictions .....	9
Maintenance .....	10
Operation .....	9
WEEE directive .....	35
Weight .....	12

This page intentionally left blank.

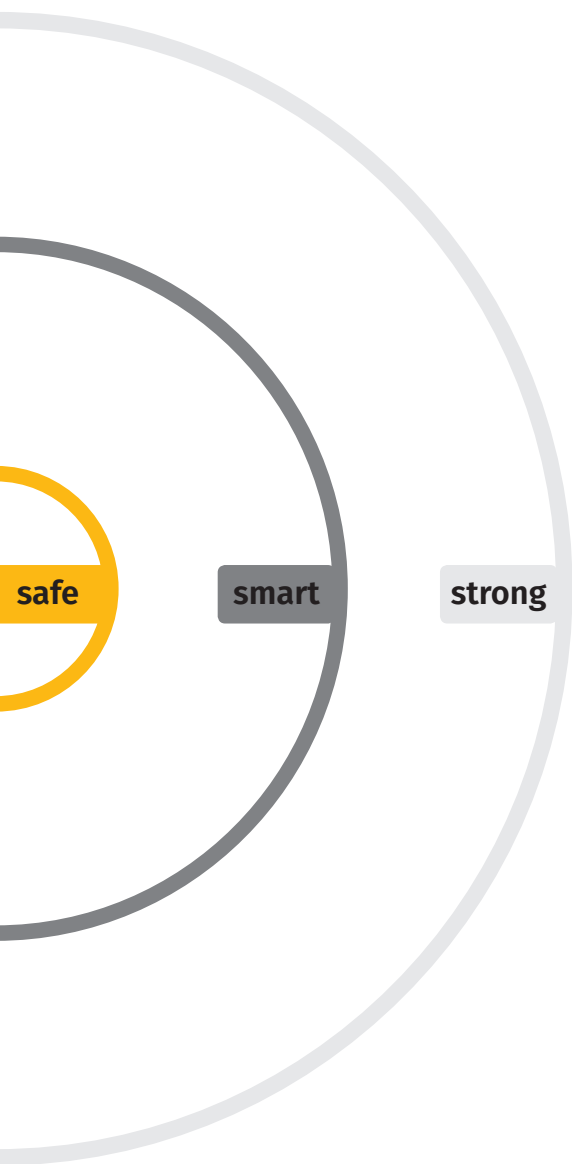

 **tele radio**<sup>®</sup>  
wireless solutions

These End user instructions are subject to change without prior notice.

Download the latest End user instructions from [www.tele-radio.com](http://www.tele-radio.com).