

**12**  
CHANNELS

OLED display  
8 bit / 16 bit  
3 kinds of DMX interfaces  
Dimming Curve: 0.1-9.9  
Short circuit/Over current/Over-heat protection

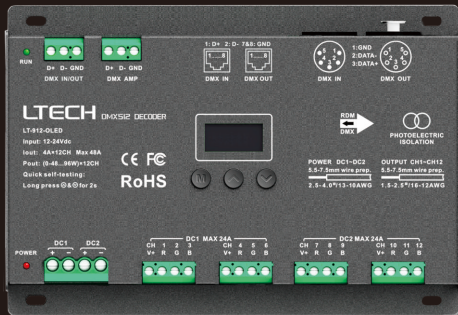

www.ltech-led.com

## Product introduction

1. Designed for Hi-power multiple channels application, 12 channels output, and Max. 4A current per channel, up to 1152W output power.
2. Easy operation with OLED screen and touch buttons.
3. 3 kinds of mode optional: single color, color temperature, RGB.
4. Support 3 kinds of DMX ports with signal isolation function: 5-pin XLR, RJ45 and green terminal (with signal amplifier function).
5. With RDM remote management protocol, the operations can be completed via the RDM master console, such as parameters browsing & setting, DMX address setting, equipment recognition, etc.
6. With firmware upgrade function.
7. With short circuit, over current and over-heat protection, as well as warning function when fault.
8. With power-on state management and fast self-testing function.
9. 16bit (65536 levels) / 8bit (256 levels) grey level optional.
10. Optional for standard, linear, LOG or custom 0.1-9.9 dimming curve.

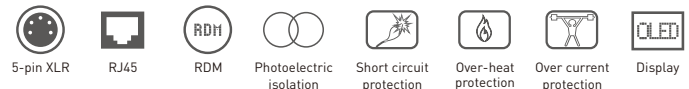
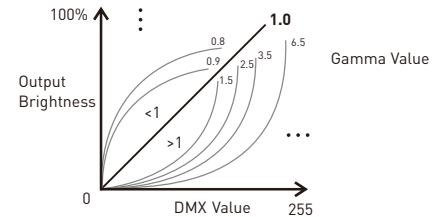

## Technical specs

Model :	LT-912-0LED
Input Signal :	DMX512/RDM
Input Voltage :	12~24Vdc
Current Load :	4A × 12CH Max 48A
Output Power :	(0~48W...96W) × 12CH Max. 1152W
DMX Interface :	5-pin XLR, RJ45, Green terminal
Control Mode :	Dimming/CT/RGB
Dimming Curve :	0.1~9.9
Grey Level :	8bit (256 levels) / 16bit (65536 levels)
Photoelectric Isolation :	Yes
Protection:	Short circuit / Over current / Over-heat
Working Temperature :	-30°C~65°C
Dimensions :	L180×W122×H39mm
Package Size :	L193×W127×H41mm
Weight (G.W.) :	730g



## Product Size:

Unit: mm

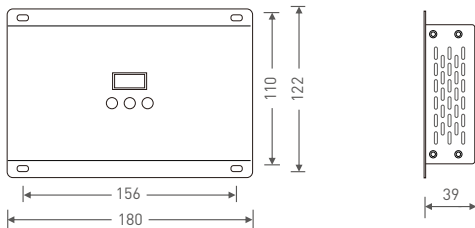

## Main component description

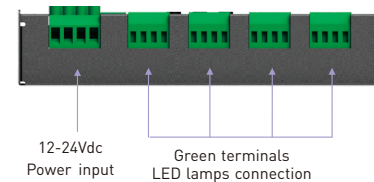
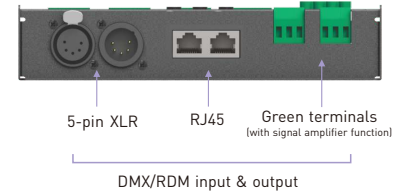
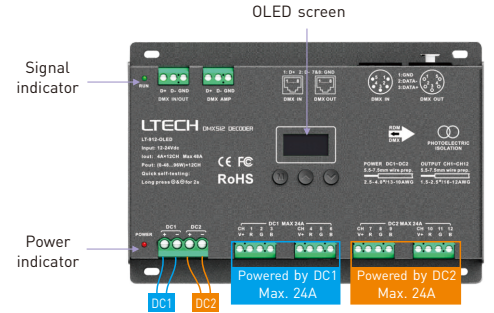

## OLED screen interface



Press "M" key, switch entries.  
 Long press "M" key, back to main page.  
 Press "^" or "v" key, parameter adjustment.  
 Exit: back to previous page.

### 1. DMX Address Setting

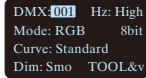

Main page

Press "^" or "v" key to set DMX address.  
 Range: 001-512

### 2. PWM Frequency

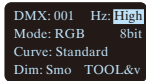

Press "^" or "v" key to choose. **No flicker in video camera.**  
 Optional : Std (standard) High (middle) Low

**Smooth and exquisite, human eye is comfortable.** \* It is recommended to use standard.

### 3. Mode

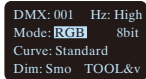

Press "^" or "v" key to choose.  
 Optional : Dim CT RGB

### 4. Grey scale

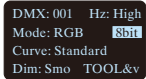

Press "^" or "v" key to choose.  
 Optional : 8bit 16bit (choose it if the master controller support this function)

### 5. Dimming curve

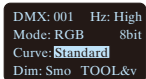

Press "^" or "v" key to choose.  
 Optional : Standard Linear LOG 0.1-9.9  
 It is recommended to use standard, 0.1-9.9 is for special requirements.

### 6. Enhance Dimming

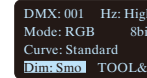

Press "^" or "v" key to choose.

Optional : Std (standard) Smo (smooth)

\* It is recommended to use standard.

Smo: This option with smooth processing, realize the dimming flicker-free and dynamic effects more downy.

### 7. Tool

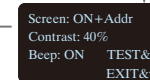
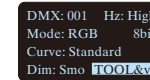

Press "^" or "v" key to enter submenu

Press "^" or "v" key to enter submenu of test.



**Screen: ON+Addr**  
 Screensaver open and display address if undo for 2 minutes.

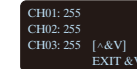

**Brightness setting** (range: 0-255)  
 Press "^" or "v" to next page  
 Press "v" to exit

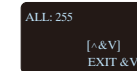

**Change all value simultaneously** (on the last page)



**Screen: ON+black**  
 Screensaver open and black if undo for 2 minutes.

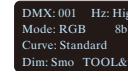

**Screen: OFF**  
 Screensaver not enable.

\* Fast self-testing function: press "^" or "v" keys simultaneously for 2-3 seconds under any page, decoder will enter self-testing function.

# Wiring diagram

## 1 Connecting LED lights:

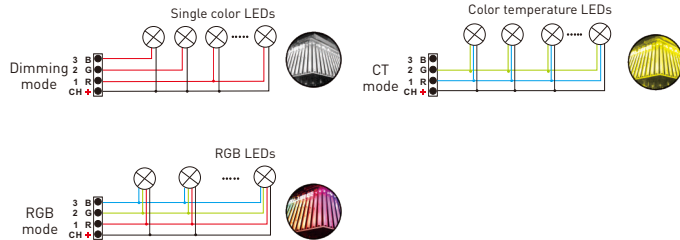
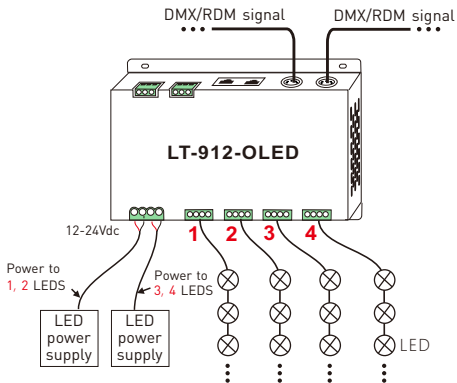
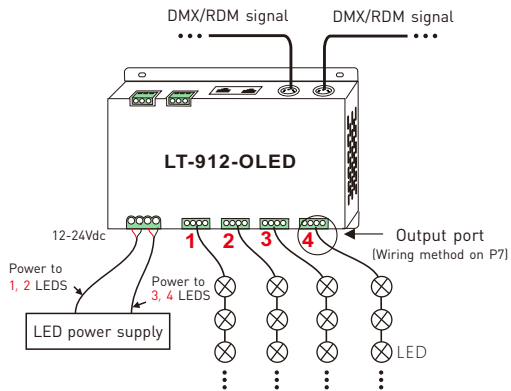

## 2. DMX console connection:

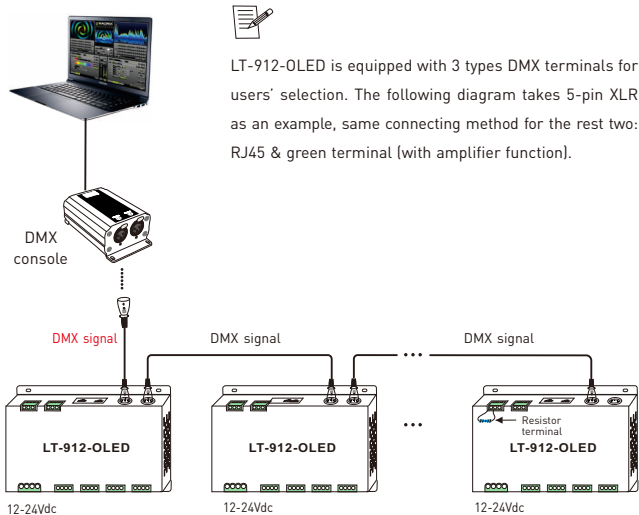

\* If the recoil effect occurs because of longer signal line or bad line quality, please try to connect 0.25W 90-120Ω terminal resistor at the end of each line.

3. The connection diagram of 3 kinds of DMX/RDM terminals:

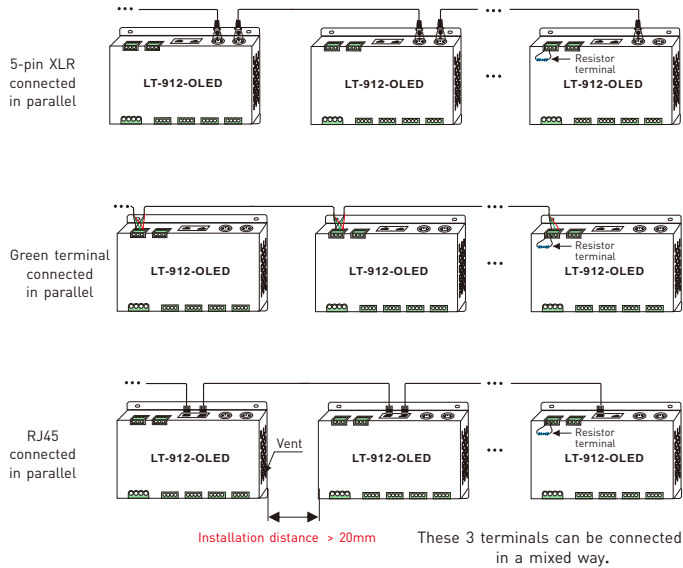

\* **Installation attention** : please reserve enough ventilation distance between decoders (>20mm), be sure not to block the vent, or will affect lifetime of decoder for poor heat dissipation.

4. The connection diagram of AMP signal amplifier terminal:

\* Connecting with green terminal or an extra amplifier will be needed when more than 32 decoders are connected or use overlong signal wire(as shown below). Signal amplifier should not be more than 5 times continuously.

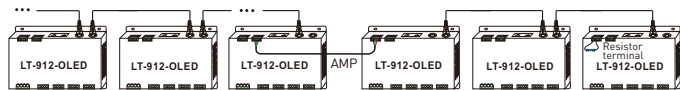

Address setting table

Mode	DIM	CT	RGB	Mode	DIM	CT	RGB		
Address Quantity	4	8	12	Address Quantity	8	16	24		
Resolution	8bit	8bit	8bit	Resolution	16bit	16bit	16bit		
Channel	1	001	001	001	Channel	1	001 002	001 002	001 002
	2	001	002	002		2	001 002	003 004	003 004
	3	001	002	003		3	001 002	003 004	005 006
	4	002	003	004		4	003 004	005 006	007 008
	5	002	004	005		5	003 004	007 008	009 010
	6	002	004	006		6	003 004	007 008	011 012
	7	003	005	007		7	005 006	009 010	013 014
	8	003	006	008		8	005 006	011 012	015 016
	9	003	006	009		9	005 006	011 012	017 018
	10	004	007	010		10	007 008	013 014	019 020
	11	004	008	011		11	007 008	015 016	021 022
	12	004	008	012		12	007 008	015 016	023 024

## Work with RDM editor

LT-912-OLED can work with LTECH RDM editor (Model: WiFi-RDM01) to realize changing the parameters by long-range setting, wiring diagram as below:

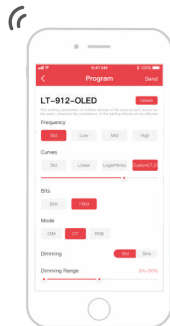
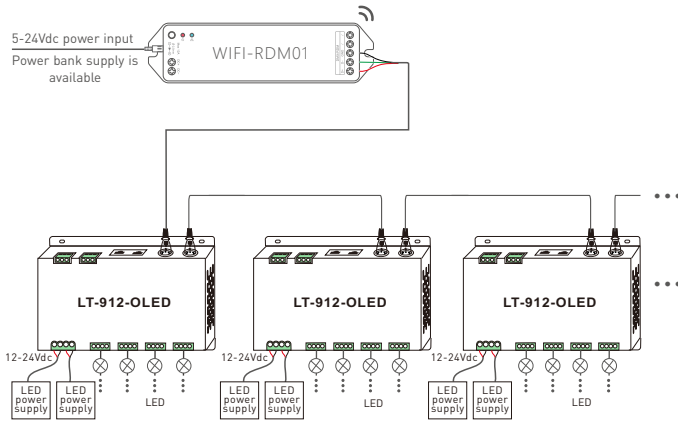

## RDM editor App interface instruction

Download the App, setting the LT-912-OLED parameters (frequency, bit, curve, modes, dimming range, screensaver, etc.) after well connecting the RDM editor, more details, please check the manual of WiFi-RDM01.

Well installation of products first, then working with WiFi-RDM01 to realize setting parameters and firmware upgrade by App.

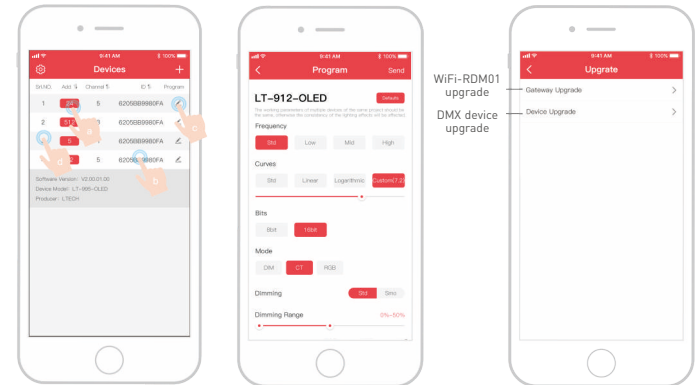

- click "Add", edited the address in corresponding box.
- Click "ID", get more product details.
- Click " ", enter edited interface
- Click "No.", issue the recognizing command.

Supporting WiFi-RDM01 upgrade and DMX driver upgrade.