

16
CHANNELS

OLED display
8 bit / 16 bit
3 kinds of DMX interfaces
Dimming Curve: 0.1-9.9
Short circuit/Over current/Over-heat protection



www.ltech-led.com

Product introduction

1. Designed for Hi-power multiple channels application, 16 channels output, and Max. 3A current per channel, up to 1152W output power.
2. Easy operation with OLED screen and touch buttons.
3. 4 kinds of mode optional: single color, color temperature, RGB and RGBW.
4. Support 3 kinds of DMX ports with signal isolation function: 5-pin XLR, RJ45 and green terminal (with signal amplifier function).
5. With RDM remote management protocol, the operations can be completed via the RDM master console, such as parameters browsing & setting, DMX address setting, equipment recognition, etc.
6. With firmware upgrade function.
7. With short circuit, over current and over-heat protection, as well as warning function when fault.
8. With power-on state management and fast self-testing function.
9. 16bit (65536 levels) / 8bit (256 levels) grey level optional.
10. Optional for standard, linear, LOG or custom 0.1-9.9 dimming curve.

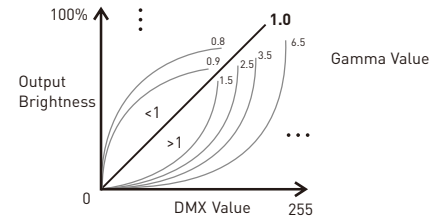

5-pin XLR



RJ45



RDM



Photoelectric isolation



Short circuit protection



Over-heat protection



Over current protection



Display

Technical specs

Model :	LT-916-0LED
Input Signal :	DMX512/RDM
Input Voltage :	12~24Vdc
Current Load :	3A × 16CH Max 48A
Output Power :	(0~36W...72W) × 16CH Max. 1152W
DMX Interface :	5-pin XLR, RJ45, Green terminal
Control Mode :	Dimming/CT/RGB/RGBW
Dimming Curve :	0.1~9.9
Grey Level :	8bit (256 levels) / 16bit (65536 levels)
Photoelectric Isolation :	Yes
Protection:	Short circuit / Over current / Over-heat
Working Temperature :	-30°C~65°C
Dimensions :	L180×W122×H39mm
Package Size :	L193×W127×H41mm
Weight (G.W.) :	730g



Product Size:

Unit: mm

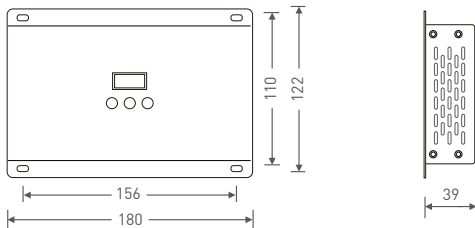

Main component description

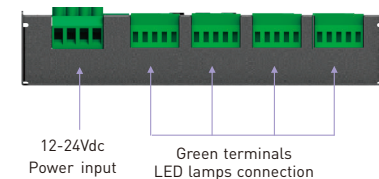
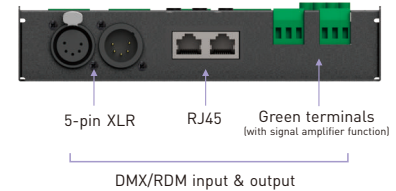
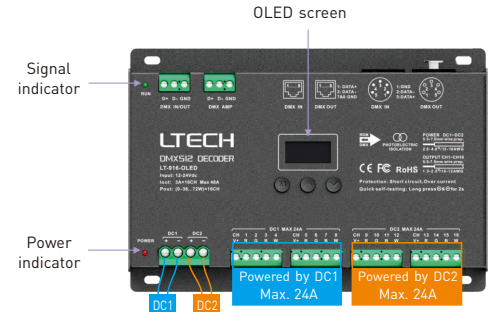

OLED screen interface



Press "M" key, switch entries.
 Long press "M" key, back to main page.
 Press "^" or "v" key, parameter adjustment.
 Exit: back to previous page.

1. DMX Address Setting

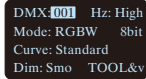

Main page

Press "^" or "v" key to set DMX address.
 Range: 001-512

2. PWM Frequency

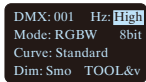

Press "^" or "v" key to choose. **No flicker in video camera.**
 Optional : Std (standard) High Mid (middle) Low

Smooth and exquisite. * It is recommended to use standard.
 human eye is comfortable.

3. Mode

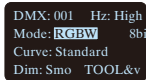

Press "^" or "v" key to choose.
 Optional : Dim/CT/RGB/RGBW

4. Grey scale

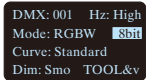

Press "^" or "v" key to choose.
 Optional : 8bit
 16bit (choose it if the master controller support this function)

5. Dimming curve

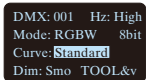

Press "^" or "v" key to choose.
 Optional : Standard
 Linear
 LOG
 0.1-9.9
 It is recommended to use standard,
 0.1-9.9 is for special requirements.

6. Enhance Dimming

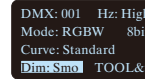

Press "^" or "v" key to choose.

Optional : Std (standard)
 Smo (smooth)

* It is recommended to use standard.

Smo: This option with smooth processing, realize the dimming flicker-free and dynamic effects more downy.

7. Tool

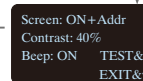
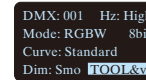

Press "^" or "v" key to enter submenu

Press "^" or "v" key to enter submenu of test.



Screen: ON+Addr
 Screensaver open and display address if undo for 2 minutes.

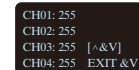

Brightness setting (range: 0-255)
 Press "^" or "v" to next page
 Press "v" to exit



Change all value simultaneously (on the last page)



Screen: ON+black
 Screensaver open and black if undo for 2 minutes.

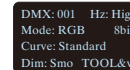

Screen: OFF
 Screensaver not enable.

* Fast self-testing function: press "^" or "v" keys simultaneously for 2-3 seconds under any page, decoder will enter self-testing function.

Wiring diagram

1 Connecting LED lights:

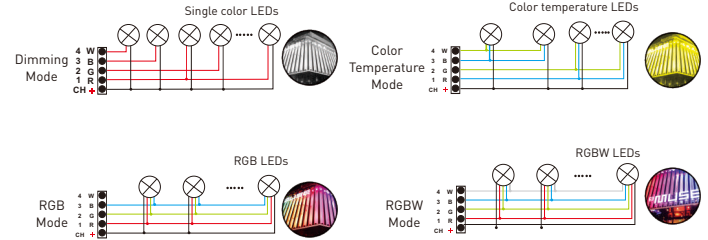
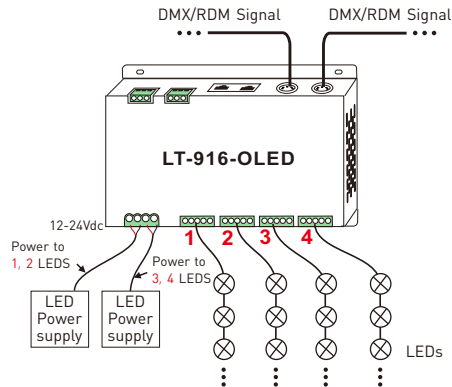
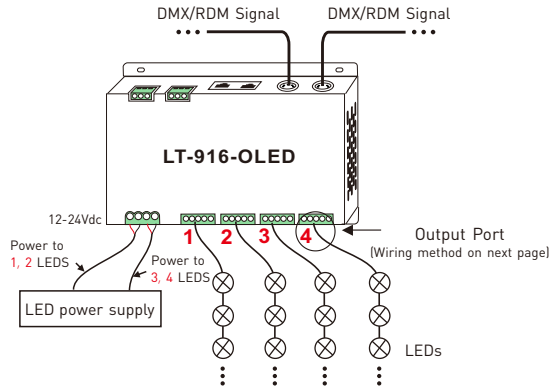

2. DMX console connection:

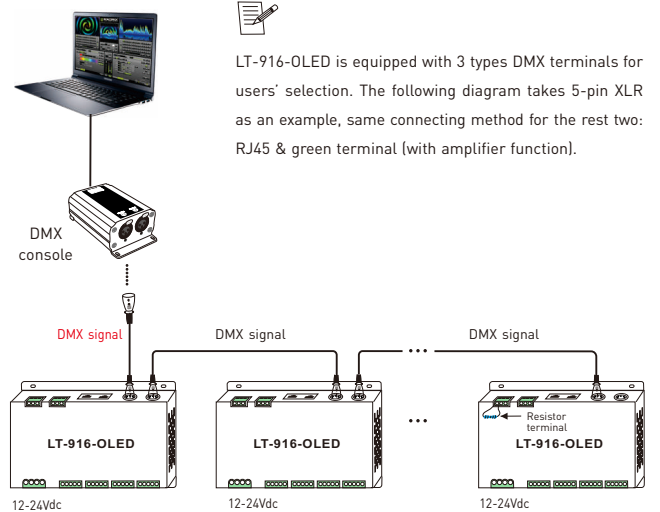

LT-916-OLED is equipped with 3 types DMX terminals for users' selection. The following diagram takes 5-pin XLR as an example, same connecting method for the rest two: RJ45 & green terminal (with amplifier function).

* If the recoil effect occurs because of longer signal line or bad line quality, please try to connect 0.25W 90-120Ω terminal resistor at the end of each line.

3. The connection diagram of 3 kinds of DMX/RDM terminals:

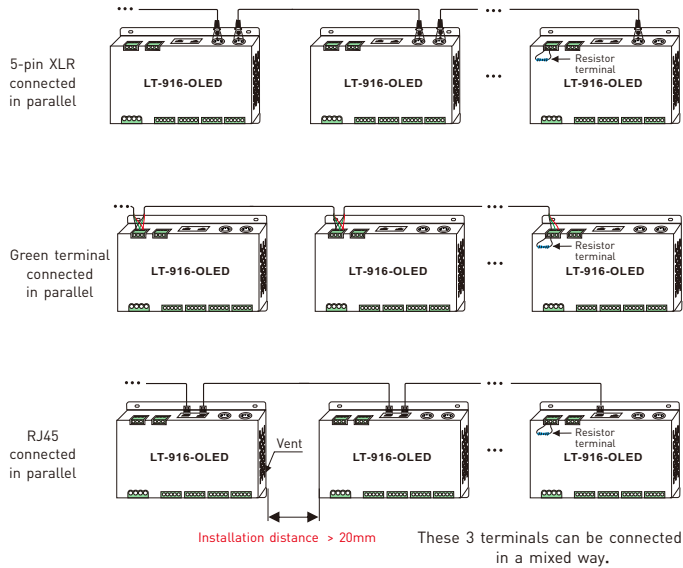

* **Installation attention** : please reserve enough ventilation distance between decoders (>20mm), be sure not to block the vent, or will affect lifetime of decoder for poor heat dissipation.

4. The connection diagram of AMP signal amplifier terminal:

* Connecting with green terminal or an extra amplifier will be needed when more than 32 decoders are connected or use overlong signal wire (as shown below). Signal amplifier should not be more than 5 times continuously.

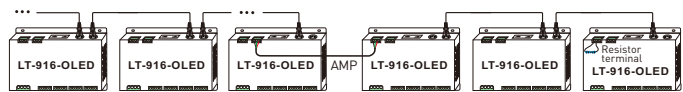

Address setting table

Mode	DIM	CT	RGB	RGBW	Mode	DIM	CT	RGB	RGBW			
Address Quantity	4	8	12	16	Address Quantity	8	16	24	32			
Resolution	8bit	8bit	8bit	8bit	Resolution	16bit	16bit	16bit	16bit			
Channel	1	001	001	001	001	Channel	1	001 002	001 002	001 002	001 002	
	2	001	002	002	002		2	001 002	003 004	003 004	003 004	003 004
	3	001	001	003	003		3	001 002	001 002	005 006	005 006	005 006
	4	001	002	003	004		4	001 002	003 004	005 006	005 007	007 008
	5	002	003	004	005		5	003 004	005 006	007 008	007 009	009 010
	6	002	004	005	006		6	003 004	007 008	009 010	011 012	011 012
	7	002	003	006	007		7	003 004	005 006	011 012	013 014	013 014
	8	002	004	006	008		8	003 004	007 008	011 012	015 016	015 016
	9	003	005	007	009		9	005 006	009 010	013 014	017 018	017 018
	10	003	006	008	010		10	005 006	011 012	015 016	019 020	019 020
	11	003	005	009	011		11	005 006	009 010	017 018	021 022	021 022
	12	003	006	009	012		12	005 006	011 012	017 018	023 024	023 024
	13	004	007	010	013		13	007 008	013 014	019 020	025 026	025 026
	14	004	008	011	014		14	007 008	015 016	021 022	027 028	027 028
	15	004	007	012	015		15	007 008	013 014	023 024	029 030	029 030
	16	004	008	012	016		16	007 008	015 016	023 024	031 032	031 032

Work with RDM editor

LT-916-OLED can work with LTECH RDM editor (Model: WiFi-RDM01) to realize changing the parameters by long-range setting, wiring diagram as below:

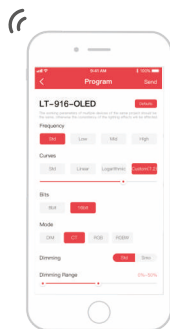
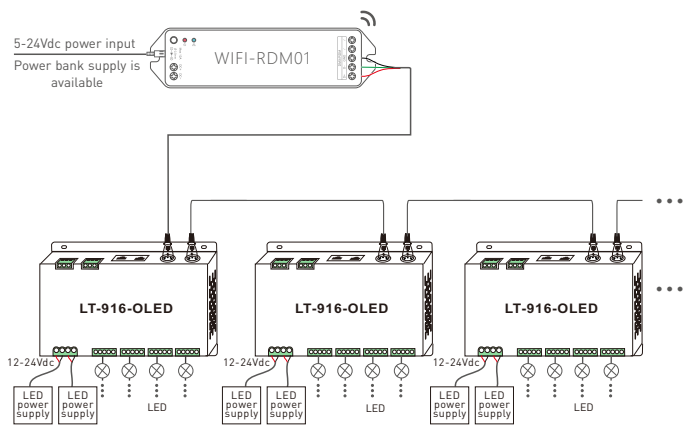

RDM editor App interface instruction

Download the App, setting the LT-916-OLED parameters (frequency, bit, curve, modes, dimming range, screensaver, etc.) after well connecting the RDM editor, more details, please check the manual of WiFi-RDM01.

Well installation of products first, then working with WiFi-RDM01 to realize setting parameters and firmware upgrade by App.

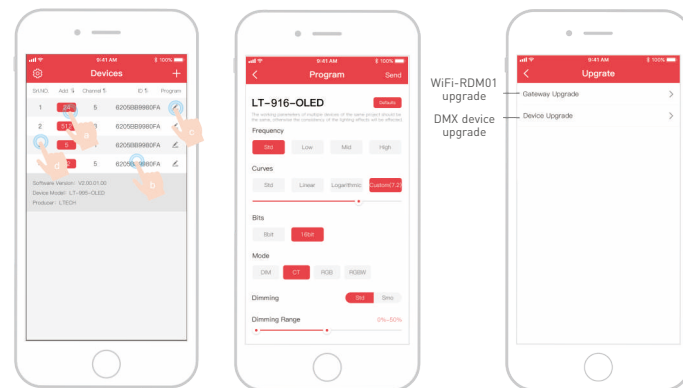

- click "Add", edited the address in corresponding box.
- Click "ID", get more product details.
- Click " ", enter edited interface
- Click "No.", issue the recognizing command.

Supporting WiFi-RDM01 upgrade and DMX driver upgrade.