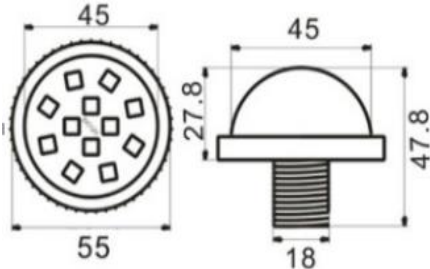

156317

Specifications

Picture	Dimension	Parameters	
			
		Lamp power	2.88W
		Chip	UCS 1903
		LED chip	SMD 5050
		LEDs number	12
		Color	RGB programmable
		IP rating	IP66
		Beam angle	≥140°
		Lifespan	≥50000h

Features

1. This product is made up of PCB, plastic cover and base, a couple of 3-pins male and female connectors. As well as a series of gluing process to ensure good water and UV resistance.
2. It is a RGB programmable product, can achieve many different light effects by using a LED controller such as K-1000c.
3. The features of this product are high brightness, low power dissipation, long lifespan, low voltage decline and excellent thermal management and lumen maintenance.
4. Customized requests are available, for example: logo, waterproof connectors, transparent or milky cover, and length of cables.
5. This product has CE and RoHS certifications.

Applications



1. Amusement Park Rides Light

Ferris wheel, Carousels, Pirate ship, Pendulum, Bumper car, Tower and so on.

2. Advertisement Outdoor Signboard Backlight

Logo, Signage, Channel letter, Signs, Exposed luminous characters, Billboard and so on.

3. Stage Decoration Light

KTV, Disco, Bar, Night club and other stage light.

4. Commercial Light

Hotel, Shopping mall, Theater, Square and so on.

5. Kids Rides Decoration

Castles, Robot, Mini carousels, Car, Mini train etc.

Packing & Weight



Weight/100pcs	Pieces/bag	Pieces/carton	G.W/carton	Carton size
3.4kg	50pcs	500pcs	19kg	46.5cm*46cm*28cm

Connection

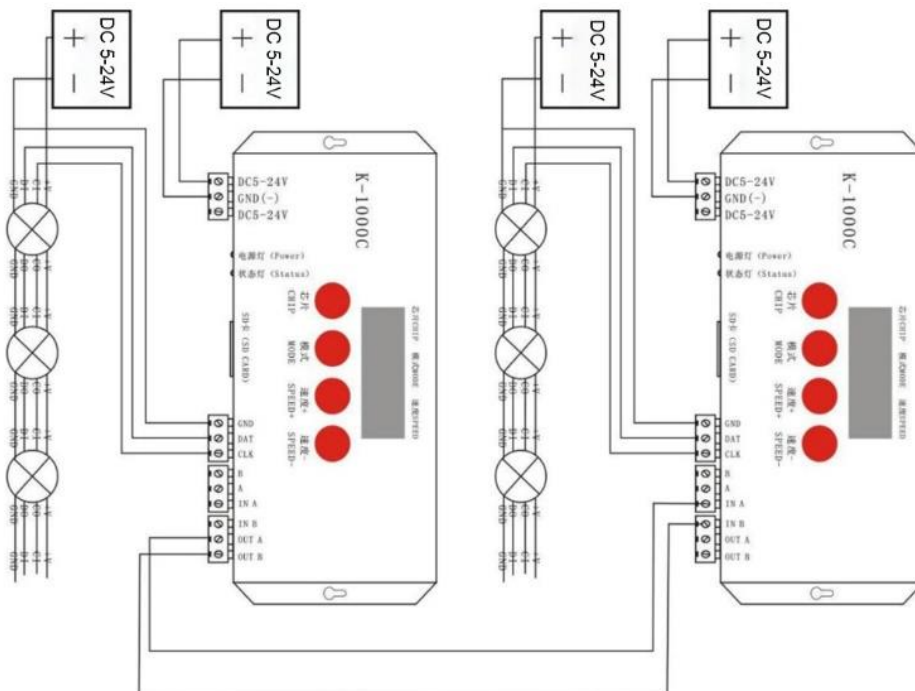

Notes:

1. Male connector (with pins) is signal input port, female connector (without pins) is signal output port.
2. We suggest that every 20pcs lights connect to the power supply in parallel to avoid voltage decline.
3. One controller can only support up to 2000 pixels, more than 2000 pixels, you need to cascade with multiple controllers.