

USER MANUAL

CIRCLE FLAMER X-F1800

V1.4
2019.4



- ★ Please read this manual carefully before operating this product.
- ★ Warranty card attached in the manual, please keep it well.

▲Warning

- Unauthorized repair are prohibited, it may cause serious incident.
- Make sure power supply is consistent with the rated voltage of the equipment, and the socket must be well grounded. Unplug and turn off the machine when not in use.
- Before connecting the power cable, communication DMX cable should be well connected and ensure the command keeps at firing OFF status. And safety lock stays at test mode.
- The device can only be placed horizontally. Safety distances are marked on the device (at least 15m in all projection directions, at least 5m to the other sides of the device).
- After turning on the device, no person allows to stay in the danger area. Ensure all persons that are part of the show are informed about the safety distance, risks and functions of the device.
- Always have a CO2 fire extinguisher and an extinguishing blanket in case of need.
- If there is any doubt as to the safety operation of the device in any circumstances, the device should be taken out of service immediately. Be sure the device is in good operating condition before use. If it fails to fire correctly, immediately shut down and check it accordingly.
- Be sure to use high quality flame fluid, otherwise, it is easily led to failure or danger. Be careful when refilling the flame fluid tank. Please keep flame fluid away from heat source, sparks, fire or other possibility of ignition. Do not smoke!
- The operator responsible for the control of Circle Flamer must always have a clear view of the device, so that he/she can stop the show immediately when there is danger. The main AC power switch should be near the operator. So that the operator can turn off the power of all devices in case of abnormal.
- The device shall not be altered and applied to other use purposes.
- **Notes for use of Battery power supply: CIRCLE FLAMER X-F1800 with stable internal circuit design, please support X-F1800 with battery voltage higher than 12V. The driving speed of motor won't change because of the decrease of battery power supply. Battery options: 12V lead-acid battery (above 30AH, with more than 24h standby). For Lithium battery, please use battery with output above 30A. Socket type: NEUTRIK-NL4FX, 4 pin sound couplers (1+ connect 12V anode, 1- connect 12V cathode). Connecting power cables should be above 14AWG.**

▲Foreword

Thanks for choosing SHOWVEN CIRCLE FLAMER X-F1800. Please read the following manual carefully and completely before operating this product. Operating according to instructions is very important for safety, and can prolong the service life of the machine.

Strictly follow the instruction in the manual when operating Circle Flamer X-F1800. If you have any doubts, please contact SHOWVEN technologies Co., Ltd by info@showven.cn.

We assume the person who uses or comes in contact with the device are familiar with how the device should be handled. This includes proper use, maintenance and repair of the machine as defined in this user manual.

Disclaimers:

SHOWVEN technologies Co., Ltd excludes liability for unsafe situations, accidents and damages resulting from:

1. Ignoring warnings or regulations as shown on circle flamer or this manual.
2. Use for other applications or circumstances other than those indicated herein.
3. Changes to the circle flamer, including use of non-original spare parts.
4. Removed safety cover without authorization from SHOWVEN.
5. Use this machine by unqualified or untrained personnel.
6. Improper use of machine.

▲Functional Characteristics

- Compact pumping system ensure compact size of machine.
- Double electromagnetic valves design for additional safety.
- Tilt protection, the tilt sensor will be activated when machine slant Over 45° .
- Unique safety lock design, device can't firing when locked, avoid spurious triggering.
- Intelligent control system: pressure monitoring, safety warning, no fuel alarming, system failure warning etc..
- High performance nozzle, reliable and durable.
- High-accuracy swiveling head driving and controlling system, allows for fast and precise flame bursts.
- Strengthened and rustproof metal panel, water-proof design.
- Neutrik PowerCON TRUE1 and DMX socket.
- Standard battery connector configuration, support 12V battery power supply.
- Fitted with fireworks igniter signal port, can be triggered by fireworks igniter
- Flame effects up to 8-10m (no wind), with 210° (±105°) swiveling angles.
- As much as 88 preset flame sequences are available. It is easier and stable to running the CIRCLE FLAMER when controlled by SHOWVEN original host controller ZK6200/6300.

▲Technical Specifications

MODEL	Circle Flamer X-F1800
Dimension	590 x 360 x 370mm
Input	AC 100-240V, 50-60Hz
Work power	380W
Interface	Double DMX Interface; 9V-60V Fireworks igniter signal port
Control	Standard DMX
Effect Maximum Height	8-10m (no wind)
Effect Angles	210° (±105°)
Fuel	ISOPROPANOL ISOPAR G,H,L,M BIOETHANOL
Fuel Bottle Capacity	10L
Weight (no fuel)	30KG
Fuel Consumption Rate	60ml/s

▲ Structure of Circle Flamer

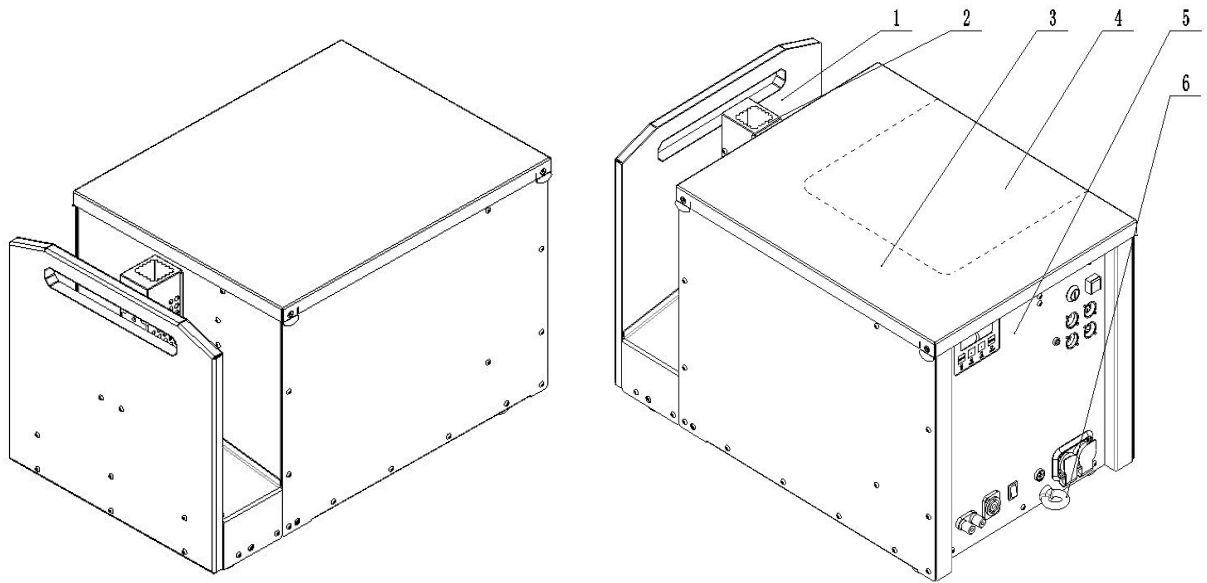

1. Handle
2. Firing Head
3. Top Panel
4. Fuel Bottle Area
5. Control Panel
6. Safety Loop

● Connection dimension diagram of bottom bracket of the flamer

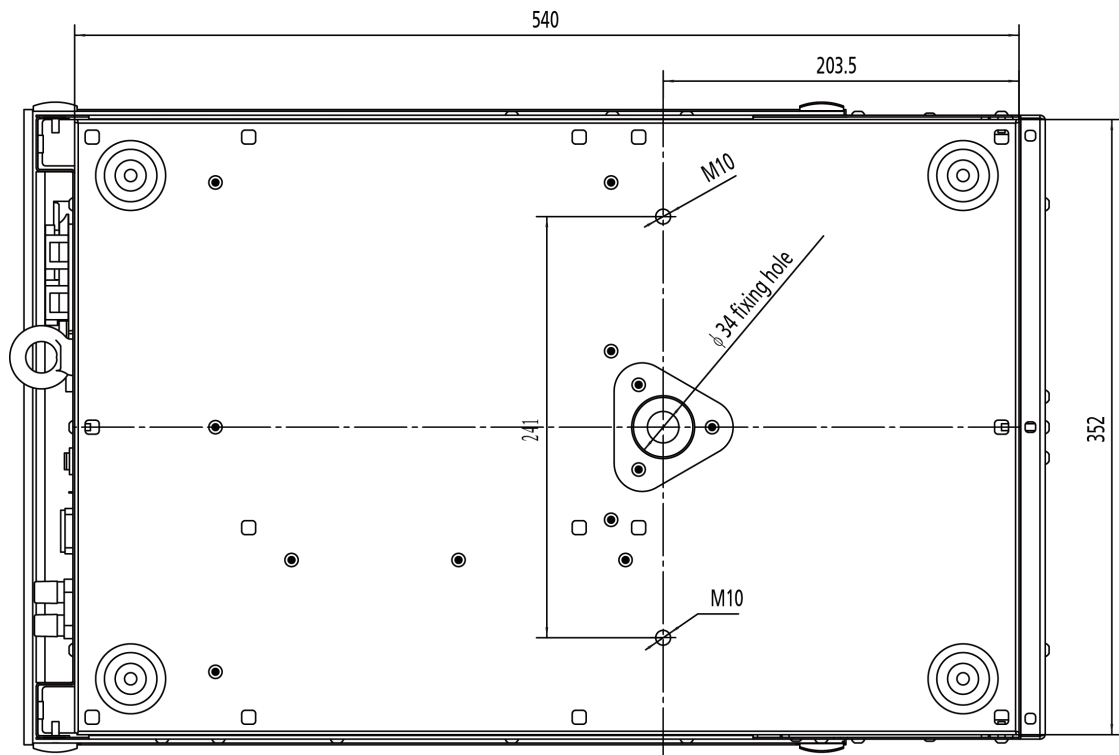

▲ Overview of Control Panel



1. LCD screen operate panel
2. Safety Lock
3. Indicator Light
4. DC 5V output
5. 3-pin DMX socket
6. 5-pin DMX socket
7. 110V/220V Power socket
8. Fuse
9. ON/OFF switch
10. 12V Battery socket
11. DC 9V-60V fireworks igniter signal port

▲ Operation Panel

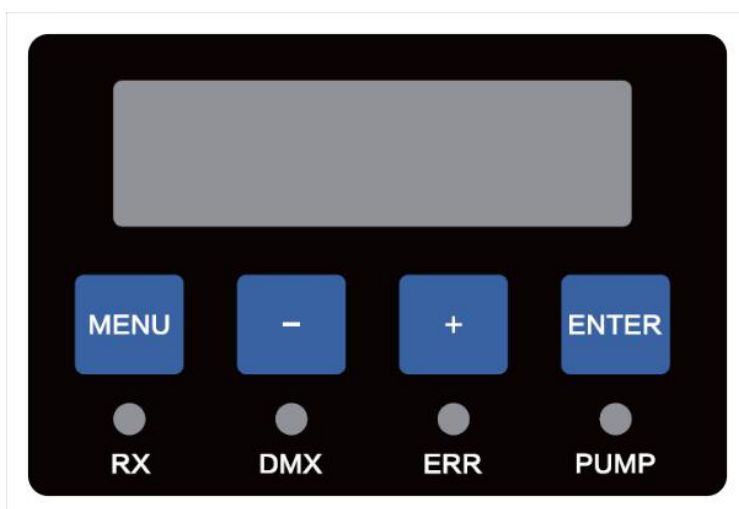

1. LED Display Area

- RX : Radio receiving (reserved)
- DMX : DMX signal. Flash means DMX signal available, otherwise no DMX signal
- ERR : Light on when there is an error
- PUMP : Light on when pump is running

2. Button Functions:

- MENU : Switch interface to setup parameter;
 - + : Parameter Up
 - : Parameter Down
 - ENTER : Confirm and save parameters (screen will flash when parameters saved)
- Note: screen display will switch to main interface if don't press button for a long time.*

3. Welcome Interface

- First Line:** Product model and software version
- Second Line:** Equipment series number

F1800-A181023
A180921016

4. Main Interface

- First Line:** DMX address;
- Second Line:** Pressure100 (e.g. 100=10bar); V: 13.6 means internal voltage is 13.6V.

DMX Address :1
P: 100 V: 13.6

5. Alert Message

Alert Message	Explanation
E0 Test Mode	Safety lock located at TEST MODE
E1 Pressure Err	Pressuriser for about 13s, pressure value failed to reach 100%, system will report E1. Possible fault: No fuel, pump failure, pipeline problem etc.
E2 P Relief Err	Pipeline can't release pressure leads to pressure relief error. Possible fault: pressure release valve failure, pipeline problem or control system problem etc.
E3 Motor Err	Possible fault: swiveling nozzle stuck, motor failure etc.
E4 ExtIgnition ON	When Ext Ignite is ON, device will pressuriser automatically when switch safety lock to USER MODE; decompression when switch to TEST MODE. 9V-60V fireworks ignitor signal will trigger related firing sequences.

E5 Voltage Err	Battery voltage>15V or <10V for continuous 5s, machine stops running Possible fault: the battery is low
E6 Tip Err	if the machine slant over 45° , it stops running, system will report E6
E7 Factory Mode	DMX signal blocked in factory mode
E8 Invert ON	When turned on, all angles will be mirrored,
E9 MotorDisable	When turned on, the position of the firing head should be moved or set manually, and the motor of firing head will be disabled. (The flamer should be restarted before it takes effect.)

6. Interface setup

Press "MENU" to switch through setup menu

Menu	Range	Explanation
Set DMX Address	1~512	DMX address setup
Angle Limit	Maxi. ANGLE : NO.1 - NO.15	Restrict nozzle rotate angles: Set by "+" and "-", and confirm by "ENTER"
	Mini. ANGLE : NO.1 - NO.15	

7. Advanced Interface

Press "MENU" 3s enter advanced interface, press "MENU" to switch interface, press "MENU" 3s can back to main interface.

Items	Contents	Description
Drive Test	OFF / Motor/ Pump / Igniter / Relief Valve / Jet Valve	
	1. Motor	Swiveling and stop at target angle.
	2. Pump	Pump running 1s, if pressure reached the target value, the pump will not running.
	3. Igniter	Ignite 1s
	4. Relief Valve	Release valve will be on and off for 3 times
	5. Jet Valve 1	Safety lock located at user mode, release pressure for 5s, jet valve will be on and off for 3 times
	6. Jet Valve 2	
Ext Ignite	OFF / ON	Trigger through 5-60V fireworks ignitor signal
Set Ext Sequence	1~88	Preset sequence triggered by fireworks ignitor
语言 (Language)	English / Chinese	Language switch
Mode Select	Normal Mode / Factory Mode	Factory mode is for test in factory only
Tip Setting	OFF / ON	Turn ON/OFF tip over function
Head to middle	OFF / ON	Channel 1=0, Firing head will remain in middle position(NO.8) after running a preset sequence.
Invert	OFF / ON	When turned on, all angles will be mirrored.
Motor Disabled	OFF / ON	When turned on, the position of the firing head should be moved or set manually, and the motor of firing head will be disabled. (The flamer should be restarted before it takes effect.)
DefaultParameter	OFF / ON	Reset default parameter settings

▲ Operation Instructions

1. Direction explanation

Please read the safety distance print on the top panel of CIRCLE FLAMER carefully.









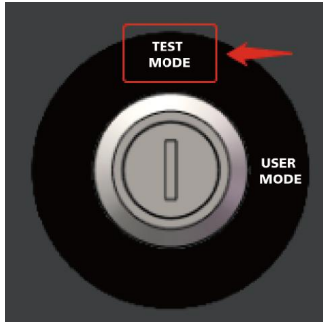
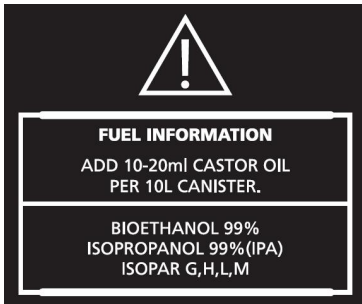

- (1) 1 to 15 is the firing angle of circle flamer, Far Right is position 15, Middle is position 8, Far Left is position 1.
- (2) Audience side and control side are indicated in above picture.
- (3) Safety distances for CIRCLE FLAMER are indicated in above picture. At least 15m in all projection directions, at least 5m to the other sides of the device.

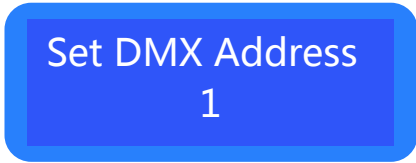
Note: in order to indicate correct direction, please place the top panel correctly.

2. Quick Operation Sheet

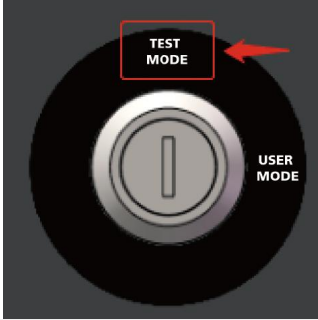
Immediately upon receiving the machine, carefully unpack the carton, check the machine received in good condition. Ensure safety operation of machine, please do following below operation procedures when operate CIRCLE FLAMER.

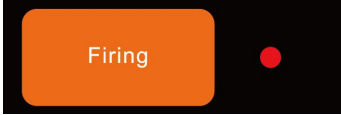
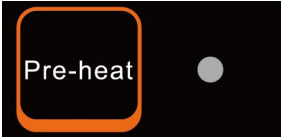
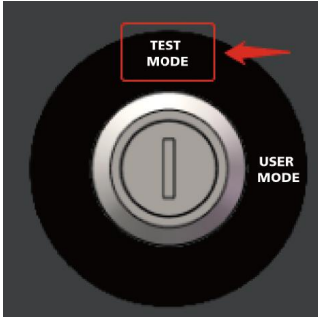
Operation step	Schematic diagram and explanation	Explanation
1. Installation	The device can only be placed horizontally, if placed on truss, please locked with extra safety ropes.	
2. Locate safety lock at TEST MODE		<p>Before operate machine please locate safety lock at TEST MODE.</p> <p>TEST MODE: operator can test the rotate of nozzle, but the fuel ejection function disabled, so there is no fuel eject and flames.</p> <p>USER MODE: the device can generate flames normally. Please strictly follow the safety distance requirement, remove all human, animal or flammable objects in the danger area.</p>
3. Fueling		Please fueling with high quality fuel according to requirement of this manual
4. Power and DMX cable connection		<p>Two kind of power supply optional:</p> <ol style="list-style-type: none"> 110V/220V main power supply 12V battery power supply
5. Switch ON the machine		Please confirm safety lock located at TEST MODE before switch on the POWER ON/OFF.
6. Set DMX address		CIRCLE FLAMER occupy 6 channels. Detail information please access to the table of page20-22.
7. Pressuriser		<p>Host controller: Press "pre-heat" button (light on)</p> <p>DMX console: switch DMX value of channel 6 to 50-200</p>

8. Check device status in TEST MODE		<p>Reconfirm safety lock located at TEST MODE before test. In this status, the nozzle will rotate, and igniter will activated, but there is no flame.</p> <p>When use DMX console to test the sequence, suggest to set CH1 at 128, so that nozzle stay at straight up position after each sequence.</p>
9. Pressure Relief		<p>Host controller: Press “pre-heat” key (light off)</p> <p>DMX console: switch DMX value of channel 6 to 0-49/201-255</p>
10. Switch safety lock to USER MODE		<p>Before switch to USER MODE, Please strictly follow the safety distance requirement, remove all human, animal or flammable objects in the danger area.</p>
11. Pressuriser		<p>Host controller: Press “pre-heat” button (light on)</p> <p>DMX console: switch DMX value of channel 6 to 50-200</p>
12. Firing		<p>Set firing sequence</p> <p>Host controller: Press “FIRING” key</p> <p>DMX console: switch DMX value of channel 3 to 254-255</p>
13. Pressure Relief		<p>Relief pressure when show finished or CIRCLE FLAMER not use for a long period.</p> <p>Host controller: Press “pre-heat” key (light off)</p> <p>DMX console: switch DMX value of channel 6 to 0-49/201-255</p>
14. Switch safety lock to TEST MODE		<p>Guarantee safety use for next time</p>
15. Power off		<p>Power off CIRCLE FLAMER, tear down power cable and DMX cable, pack up the device when it is cooled down.</p>

3. Firing Angles

The firing angle for CIRCLE FLAMER is $\pm 105^\circ$, from the Audience Side view, there are altogether 15 firing angles as below.

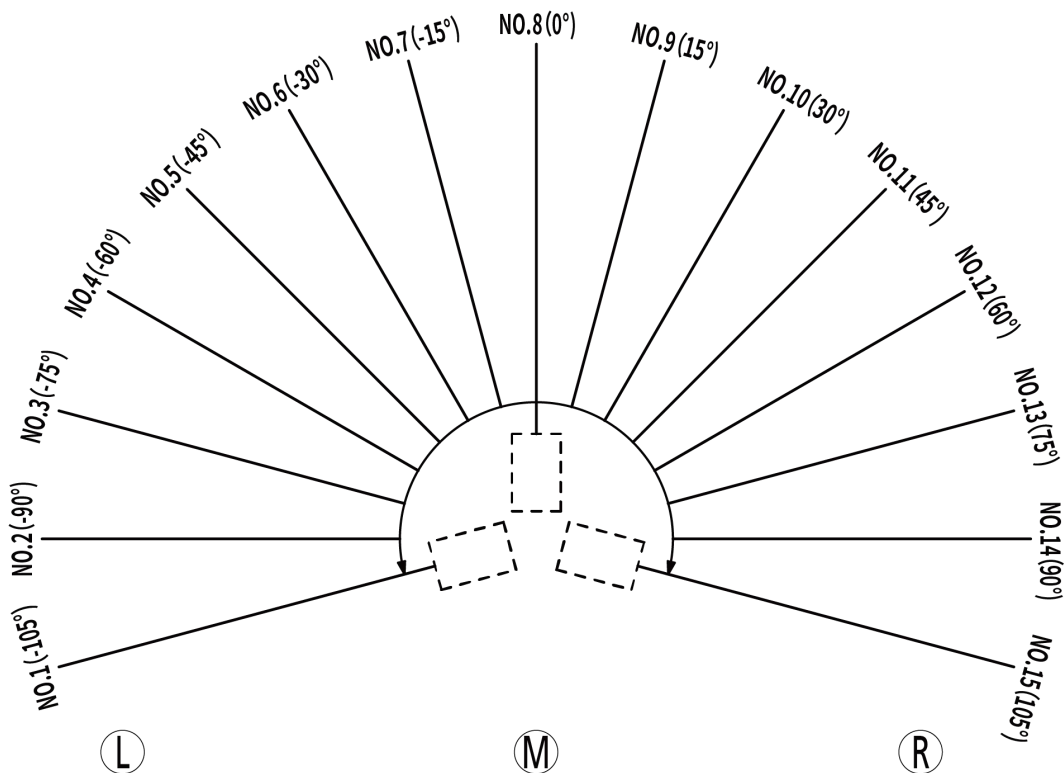

4. Drive time for Effects

Time needed for the motor drive from NO.8 to relevant angle.

No.	Angles	Drive time needed
NO.1	-105°	170ms
NO.2	-90°	150ms
NO.3	-75°	130ms
NO.4	-60°	110ms
NO.5	-45°	90ms
NO.6	-30°	70ms
NO.7	-15°	50ms
NO.8	0°	0ms
NO.9	15°	50ms
NO.10	30°	70ms
NO.11	45°	90ms
NO.12	60°	110ms
NO.13	75°	130ms
NO.14	90°	150ms
NO.15	105°	170ms

For example for the motor drive from 0° to 45°, it need 90ms, when operator design a show to synchronize to music, this drive time must be calculated.

5. Control of Circle Flamer

Circle Flamer X-F1800 has 88 preset sequences, operator use related channel DMX value or sequence No. to access certain sequence. Below, you can find sequence list and single ignitions.

Single Ignition Sequence List

No.	Ignition angle	Description	Nozzle Movement	Firing Duration (For reference)	CH5 DMX Reference Value
1	-105°	Single Ignition SHORT flame	Static	0.19s	3-5
2	-90°	Single Ignition SHORT flame	Static	0.19s	6-7
3	-75°	Single Ignition SHORT flame	Static	0.19s	8-10
4	-60°	Single Ignition SHORT flame	Static	0.19s	11-12
5	-45°	Single Ignition SHORT flame	Static	0.19s	13-15
6	-30°	Single Ignition SHORT flame	Static	0.19s	16-17
7	-15°	Single Ignition SHORT flame	Static	0.19s	18-20
8	0°	Single Ignition SHORT flame	Static	0.19s	21-22
9	15°	Single Ignition SHORT flame	Static	0.19s	23-25
10	30°	Single Ignition SHORT flame	Static	0.19s	26-28
11	45°	Single Ignition SHORT flame	Static	0.19s	29-30
12	60°	Single Ignition SHORT flame	Static	0.19s	31-33
13	75°	Single Ignition SHORT flame	Static	0.19s	34-35
14	90°	Single Ignition SHORT flame	Static	0.19s	36-38
15	105°	Single Ignition SHORT flame	Static	0.19s	39-40
16	-105°	Single Ignition LONG flame	Static	0.56s	41-43
17	-90°	Single Ignition LONG flame	Static	0.56s	44-45
18	-75°	Single Ignition LONG flame	Static	0.56s	46-48
19	-60°	Single Ignition LONG flame	Static	0.56s	49-50
20	-45°	Single Ignition LONG flame	Static	0.56s	51-53
21	-30°	Single Ignition LONG flame	Static	0.56s	54-56
22	-15°	Single Ignition LONG flame	Static	0.56s	57-58
23	0°	Single Ignition LONG flame	Static	0.56s	59-61
24	15°	Single Ignition LONG flame	Static	0.56s	62-63
25	30°	Single Ignition LONG flame	Static	0.56s	64-66
26	45°	Single Ignition LONG flame	Static	0.56s	67-68
27	60°	Single Ignition LONG flame	Static	0.56s	69-71
28	75°	Single Ignition LONG flame	Static	0.56s	72-73
29	90°	Single Ignition LONG flame	Static	0.56s	74-76
30	105°	Single Ignition LONG flame	Static	0.56s	77-79

Step Sequences List

No.	Ignition angle NO.	Description	Nozzle movement	Firing Duration (For reference)	CH5 DMX Reference Value
31	Step from 1-15	SHORT flame Step sequence	L -> R	2.66s	80-81
32	Step from 15-1	SHORT flame Step sequence	R -> L	2.66s	82-84
33	Step 5>8>11	SHORT flame Step sequence	L -> R	0.92s	85-86
34	Step 11>8>5	SHORT flame Step sequence	R -> L	0.92s	87-89
35	Step 6>10	SHORT flame Step sequence	L -> R	0.75s	90-91
36	Step 10>6	SHORT flame Step sequence	R -> L	0.75s	92-94
37	Step 4>6>8>10>12	SHORT flame Step sequence	L -> R	1.27s	95-96
38	Step 12>10>8>6>4	SHORT flame Step sequence	R -> L	1.27s	97-99
39	Step 8>6>10>4>12	SHORT flame Step sequence	M>L>R>L>R	1.60s	100-101
40	Step 8>10>6>12>4	SHORT flame Step sequence	M>R>L>R>L	1.60s	102-104
41	Step from 1-15	LONG flame Step sequence	L -> R	7.78s	105-107
42	Step from 15-1	LONG flame Step sequence	R -> L	7.78s	108-109
43	Step 5>8>11	LONG flame Step sequence	L -> R	1.82s	110-112
44	Step 11>8>5	LONG flame Step sequence	R -> L	1.82s	113-114
45	Step 6>10	LONG flame Step sequence	L -> R	1.25s	115-117
46	Step 10>6	LONG flame Step sequence	R -> L	1.25s	118-119

47	Step 4>6>8>10>12	LONG flame Step sequence	L -> R	2.68s	120-122
48	Step 12>10>8>6>4	LONG flame Step sequence	R -> L	2.68s	123-124
49	Step 8>6>10>4>12	LONG flame Step sequence	M>L>R>L>R	2.88s	125-127
50	Step 8>10>6>12>4	LONG flame Step sequence	M>R>L>R>L	2.88s	128-130

Wave Sequence List

No.	Ignition angle NO.	Description	Nozzle movement	Firing Duration (For reference)	CH5 DMX Reference Value
51	Wave 5 -->11	Middle wave sequence	L -> R	1.87s	131-132
52	Wave 11-->5	Middle wave sequence	R -> L	1.87s	133-135
53	Big wave 1--15	LONG wave sequence	L -> R	4.08s	136-137
54	Big wave 15--1	LONG wave sequence	R -> L	4.08s	138-140
55	Wave 8-->1	Middle wave sequence	M -> L	2.09s	141-142
56	Wave 8-->15	Middle wave sequence	M -> R	2.09s	143-145
57	Wave 1-->8	Middle wave sequence	L -> M	2.31s	146-147
58	Wave 15-->8	Middle wave sequence	R -> M	2.31s	148-150
59	Wave 8-->11	SHORT wave sequence	M -> R	0.99s	151-152
60	Wave 8-->5	SHORT wave sequence	M -> L	0.99s	153-155
61	Wave 5-->8	SHORT wave sequence	L -> M	1.08s	156-158
62	Wave 11-->8	SHORT wave sequence	R -> M	1.08s	159-160

Additional Sequences List

No.	Ignition angle NO.	Description	Nozzle movement	Firing Duration (For reference)	CH5 DMX Reference Value
63	Step 3>13	SHORT flame Step sequence	L -> R	0.93s	161-163
64	Step 13>3	SHORT flame Step sequence	R -> L	0.93s	164-165
65	Step 3>13	LONG flame Step sequence	L -> R	1.63s	166-168
66	Step 13>3	LONG flame Step sequence	R -> L	1.63s	169-170
67	Step 8-13	SHORT flame Step sequence	M -> R	1.55s	171-173
68	Step 13-8	SHORT flame Step sequence	R -> M	1.55s	174-175
69	Step 8-13	LONG flame Step sequence	M -> R	3.24s	176-178
70	Step 13-8	LONG flame Step sequence	R -> M	3.24s	179-181
71	Step 8-3	SHORT flame Step sequence	M -> L	1.54s	182-183
72	Step 3-8	SHORT flame Step sequence	L -> M	1.54s	184-186
73	Step 8-3	LONG flame Step sequence	M -> L	3.24s	187-188
74	Step 3-8	LONG flame Step sequence	L -> M	3.24s	189-191
75	Step 3-13	SHORT flame Step sequence	L -> R	1.98s	192-193
76	Step 13-3	SHORT flame Step sequence	R -> L	1.98s	194-196
77	Step 2-14	SHORT flame Step sequence	L -> R	2.32s	197-198
78	Step 14-2	SHORT flame Step sequence	R -> L	2.32s	199-201
79	Step 8>5>11	SHORT flame Step sequence	M>L>R	0.93s	202-203
80	Step 8>11>5	SHORT flame Step sequence	M>R>L	0.93s	204-206
81	Step 5-11	SHORT flame Step sequence	L -> R	1.28s	207-209
82	Step 11-5	SHORT flame Step sequence	R -> L	1.28s	210-211
83	Wave 8-->13	Middle wave sequence	M -> R	1.70s	212-214
84	Wave 13-->8	Middle wave sequence	R -> M	1.70s	215-216
85	Wave 8-->3	Middle wave sequence	M -> L	1.60s	217-219
86	Wave 3-->8	Middle wave sequence	L -> M	1.60s	220-221
87	Wave 3-->13	LONG wave sequence	L -> R	3.06s	222-224
88	Wave 13-->3	LONG wave sequence	R -> L	3.06s	225-226
>89	8(0°)	Single Ignition LONG flame	Static	max. 8s	227-255

6. DMX CONTROL

Channel	Function
CH1	Manual Angle setup: (0~255) angle change from -105° to 105°, (128) is straight upward (0°)
CH2	Manual Speed setup: (0) Max Speed, (1~254) Speed increase, (255) Max Speed
CH3	Ignition ON/OFF: (0~253) Ignition OFF, (254~255) Ignition ON
CH4	Firing Duration setup: 0 and 255 is permanent fire (8s is limit duration time); 1~254 is 10~2540ms duration time (Manual firing duration = DMX Value * 10ms)
CH5	Program sequence setup: (0-2) no preset sequence; (3-255) preset sequence. DMX value = 2 + Sequence No.*2.55 (ROUND OFF)
CH6	Mode setup: (0~49) Pressure Relief Mode (Emergency Stop), (50~200) Compression Mode, (201~255) Pressure Relief Mode (Emergency Stop)

Channel 1 (CH1): Angle Setup

Angle No.	Angle	DMX Value
1	-105°	0
2	-90°	18
3	-75°	36
4	-60°	54
5	-45°	73
6	-30°	91
7	-15°	109
8	0°	128
9	15°	146
10	30°	165
11	45°	183
12	60°	201
13	75°	219
14	90°	237
15	105°	255

1. The first channel controls the firing angle. It defines to which angle the nozzle of CIRCLE FLAMER move to. The angle can be chosen anywhere between -105° to +105° (DMX value 0 to 255).
2. The DMX value for angle of 0° is 127.5 (round up 128). Use this value, following formula can be used to calculate all other angles ∠ in degree. Please always note the prefix of the angle.

$$\text{DMX Value} = 127.5 + (\angle * 1.2145)$$

Channel 2 (CH2): Speed Setup

CH2: Speed Setup			
DMX Value	0	1-254	255
Speed	Max Speed	Incremental of Speed	Max Speed

The second channel defines the rotate speed. It work together with Channel 1 for manual firing.

Channel 3 (CH3): Ignition ON/OFF

CH3: Ignition		
DMX Value	0-253	254-255
Ignition	CIRCLE FLAMER won't ignite	CIRCLE FLAMER ignites

The third channel activates the actual ignition. If the DMX value of this channel higher than 253, the CIRCLE FLAMER will ignite.

Channel 4 (CH4): Firing Duration setup

CH4: Manual Firing Duration setup								
DMX Value	0	1	2	3	4	254	255
Firing Duration	Permanent	10ms	20ms	30ms	40ms	2540ms	Permanent

The fourth channel is the firing duration setup.

Below formula can be used to calculate the firing duration (ms):

$$\text{DMX Value} = t/10$$

Channel 5 (CH5): Program Sequence setup

The fifth Channel allows to firing a preset sequence. Three DMX values can be used for one of the programmed firing sequence from above sequence list (refer to above sequence list table).

Below formula can be used to calculate firing sequence:

$$\text{DMX Value} = 2 + \text{Sequence No.} * 2.55$$

CH5: Sequence List							
DMX Value	0~2	3~5	6~7	8~10	11~12	225-226
Sequence No.	N/A	1	2	3	4	88

Channel 6 (CH6): Mode setup

The sixth channel is the working mode of pump.

When the safety lock located at TEST MODE, set DMX value between 50-200 to test the system. For safety, the device will not pressuriser.

When the safety lock located at USER MODE, the device pressuriser activated by set DMX value between 50-200. The device can only make ignitions in Firing mode.

CH6: Mode setup			
DMX Value	0-49	50-200	201-255
Mode	Pressure Relief Mode	Firing Mode	Pressure Relief Mode

·Example 1: DMX console control

- Set nozzle straight up
(CH1 Angle = 128, CH2 Speed = 0, CH3 Ignition = 0, CH4 Firing duration = 0, CH5 Program sequence = 0, CH6 Firing mode = 50~200)
- Set preset Sequence No. 31
(CH1 Angle = 128, CH2 Speed = 0, CH3 Ignition = 0, CH4 Firing duration = 0, CH5 Program sequence DMX value = 80, CH6 Firing mode = 50~200)
- Ignition
(CH1 Angle = 128, CH2 Speed = 0, CH3 Ignition = 255, CH4 Firing duration = 0, CH5 Program sequence DMX value = 80, CH6 Firing mode = 50~200)

Note: After firing, the DMX value of CH3 must back to 0, before an ignition can be made again. CH1 determines the nozzle direction after firing.

·Example of Wave Firing by DMX console

- Set firing nozzle to the start point
(CH1 Angle = 0, CH2 Speed = 255, CH3 Ignition = 0, CH6 Firing mode = 50~200)
- Set wave speed
(CH1 Angle = 0, CH2 Speed = 50, CH3 Ignition = 0, CH6 Firing mode = 50~200)
- Set firing end point and ignition
(CH1 Angle = 255, CH2 Speed = 50, CH3 Ignition = 255, CH6 Firing mode = 50~200)

4. Firing Nozzle will firing and make movement from start point to end point

Note: After firing, The DMX value of CH3 must back to 0, before an ignition can be made again.

·Example of firing with fixed duration by DMX console

1. Set nozzle straight up
(CH1 Angle = 128, CH2 Speed = 0, CH3 Ignition = 0, CH4 Firing duration = 0, CH6 Firing mode = 50~200)
2. Set firing duration 1s
(CH1 Angle = 128, CH2 Speed = 0, CH3 Ignition = 0, CH4 Firing duration = 100, CH6 Firing mode = 50~200)
(Note: Firing duration = DMX value * 10ms [1s])
3. Firing 1s
(CH1 Angle = 128, CH2 Speed = 0, CH3 Ignition = 255, CH4 Firing duration = 100, CH6 Firing mode = 50~200)

Note: After firing, The DMX value of CH3 must back to 0, before an ignition can be made again.

7. Operating with SHOWVEN host controller ZK6200/ZK6300

1) Hardware description

Host controller model: ZK6200	
	Parameters:
	Dimension: 390×300×110mm
	Weight: 3.5kg
	Input: 110-240Vac, 50/60Hz
	Work power: 15w
	Work Temp.: -10°C ~ 50 °C
	Interface: 2*CAN port, 2* media port (music trigger), 2*MIDI port (music trigger), 1* DMX512 input, 1*DMX512 output.
	Support Max. 200m communication cable 3350 mAH Li-battery (5h battery life when fully charged)

SHOWVEN host controller introduction

- a) Standard DMX512 signal output.
- b) Support 18units CIRCLE FLAMER (ZK6200) or 54units CIRCLE FLAMER (ZK6300) at the same time.
- c) 5 standard dynamic modes: Synchronization, Center to Ends, Ends to Center, Left to Right, Right to Left. And an user definable Special Effect mode, support 8 files, each file support 36000 lines maximum (effects lasts for 30min).
- d) Multi trigger sources: manual, music or midi input.
- e) RDMX monitoring function: system can send back circle flamer working status info such as pressure, warming etc. and display on the screen.
- f) Emergency stop function.

2) Operational Panel



- a) Cable Connection Area
 AC Input: AC Power Input
 CAN: CAN communication input/output
 MIDI In: Midi time synchronous signal input
 DMX 512: DMX signal input/output
 LAN: network interface
 USB: program download interface, SparkularEdit200 software port
- b) Manual firing operation region



- c) Mode Selection Area



There are 5 standard dynamic mode and 1 special effects mode. Each mode support 8 files, it can be switched easily on the mode selection area.

- d) LCD display Area
 F1: Main menu
 F2: File selection
 F3: Configuration
 F4: About host controller
- e) Edit/Control Area

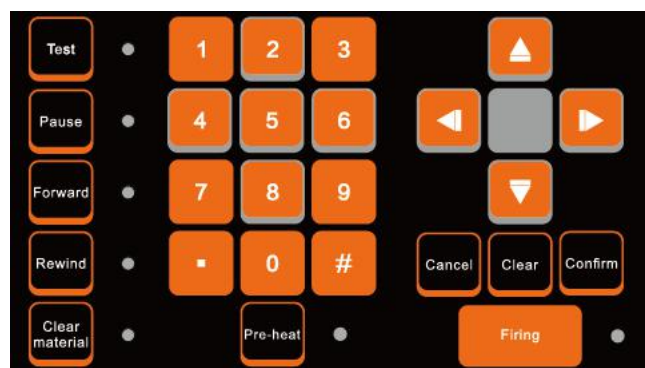

Set circle flamer DMX address as below:

CIRCLE FLAMER No.	DMX address
1	1
2	7
3	13
4	19
5	25
6	31
7	37
8	43
9	49
10	55
11	61
12	67
13	73
14	79
15	85
16	91
17	97
18	103

Note: wrong DMX address setup may leads to circle flamer out of control.

Host controller ZK6200 setup as below:

1. Press "F3" enter host controller configuration menu, DEVICE choose "CIRCLE FLAMER" as below.
2. Set Start No. and End No. of device.

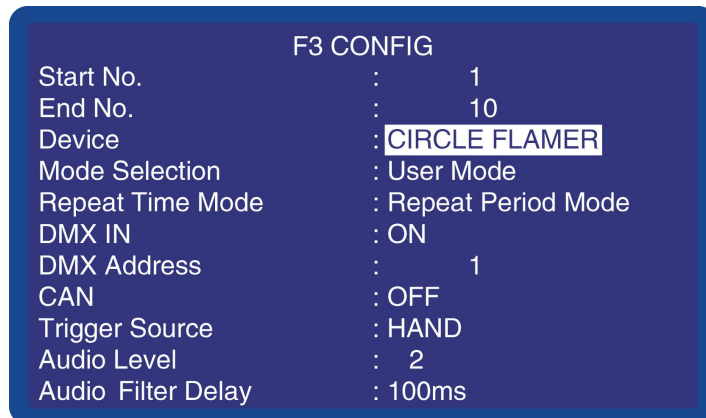

Press "F1" back to main interface.

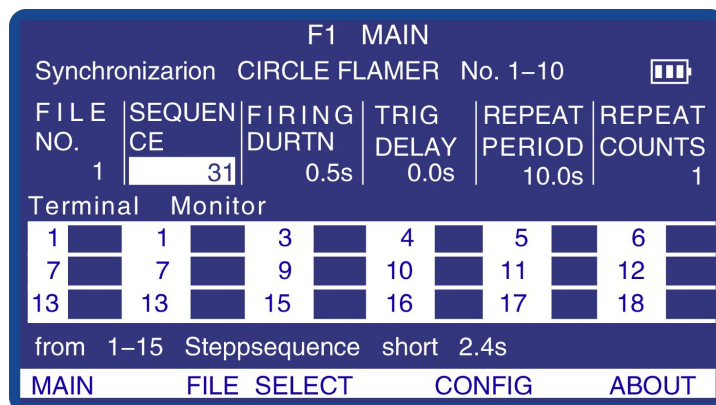

Press "PRE-HEAT", activate the compression of device.

1. Manual firing: Enter SEQUENCE No.8, press 1-18 to firing each unit, CIRCLE FLAMER can only firing at vertical upward.

2. Sequence firing: eg: firing at SEQUENCE 31, entering 31 at SEQUENCE, entering FIRING DURATION (Firing duration normally set at 0.5s, even the sequence firing duration is longer than 0.5s, the SEQUENCE will fully executed) , set the repeat counts, press "FIRING" to activate the device.

Note: Put safety lock at "TEST MODE" to check the signal connection and nozzle rotation status before use the device for firing.

For Emergency stop, press "PRE-HEAT", device will enter pressure relief mode, and stop emergently.

▲Maintenance

1. To maintain the system in good performance and running status, it is recommended to running the device at least once per month.
2. Maintenance of the nozzle: Nozzle need to be cleaned up , and it is recommended that once every six months (depending on the environment and frequency of use). In the process of using the equipment, if the flame shape is seriously deformed or the fuel injection line is significantly deformed or coarsened, the nozzle should be removed immediately for cleaning.
3. Maintenance of the O-ring: If it is found that the O-ring of the nozzle is damaged or ageing when cleaning the nozzle, the O-ring should be replaced in time (material and size of O-ring: fluororubber O-ring, the outermost diameter is 14 mm, and the line diameter is 2 mm).
4. In order to lubricate the pipeline and pump it is highly recommended to add 10-20ml castor oil per 10L canister.
5. Software can be upgraded with download cable from SHOWVEN.
6. Switchable power input design, switchable between 110V and 220V as show below (voltage will show on it). The power supply is located on the side of the electric control, and you should remove the cover in order to change it.

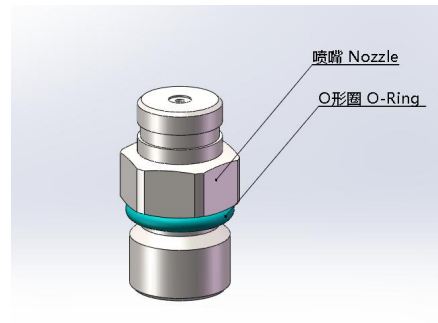

Warranty Instructions

▲Sincere thanks for your choosing CIRCLE FLAMER X-F1800, you will receive quality service from us.

▲The product warranty period is one year. If there are any quality problems within 7 days after shipping out from our factory, we can exchange a brand new same model machine for you.

▲We will offer free of charge maintenance service for machines which with hardware malfunction (except for the instrument damage caused by human factors)in warranty period. Please don't repair machine without factory permission.

★Below situations NOT included in warranty service:

- 1.Damage caused by improper transportation, usage, management, and maintenance, or damage caused by human factors;
- 2.Disassemble, modify or repair products without Showven's permission;
- 3.Damage caused by external reasons (lightning strike, power supply etc)
- 4.Damage caused by improper installation or use;

For product damage not included in warranty range, we can provide paid service.

★Invoice and warranty card are necessary when applying for maintenance service from SHOWVEN.

Warranty Card

Product Name:		Serial No.	
Purchase Date:			
Tel:			
Address:			
Info.feedback about the problem			
Actual problem:			
Maintenance detail:			
Service Engineer:		Service Date:	

SHOWVEN[®]



Showven Technologies Co., Ltd.

Add: Building B1, Changsha E Center No.18, Xiangtai Road, Liuyang Economic Development Zone, Changsha City, 410300, Hunan Province, P.R.China.

Tel: +86-731-83833068

Web: www.showven.cn

E-mail: info@showven.cn